

A nighttime photograph of a city skyline with a complex multi-level highway interchange in the foreground. The buildings are illuminated with various lights, and the highway shows long-exposure light trails from cars. The sky is dark with some clouds.

LUSAS

Application Manual

LUSAS Bridge
LUSAS Civil & Structural

Application Manual (Bridge, Civil & Structural)

LUSAS Version 18.0 Issue 1

LUSAS

Forge House, 66 High Street, Kingston upon Thames,
Surrey, KT1 1HN, United Kingdom

Tel: +44 (0)20 8541 1999

Fax +44 (0)20 8549 9399

Email: info@lusas.com

<http://www.lusas.com>

Distributors Worldwide

Copyright ©1982-2019 LUSAS
All Rights Reserved.

Table of Contents

Introduction	1
Software Products Covered	1
Bridge Menu	1
Civil Menu	2
Availability of Bridge or Civil menu items according to software product.	4
Design Menu	4
Grillage Wizard	7
Overview	7
Section generators and property calculators	11
Precast Beam Section Generator	11
Box Section Property Calculators	13
Infilled / Encased Section Property Calculator	21
Plate Section Property Calculator	24
Bridge Loading	27
Overview	27
Gravity Loading	27
Surface Loading	27
Static Vehicle Loads	28
Australia Vehicle Loading	30
Canada Vehicle Loading	33
China Vehicle Loading	35
Denmark Vehicle Loading	37
Eurocode Vehicle Loading	39
Finland Vehicle Loading	45
India Vehicle Loading	49
Israel Vehicle Loading	51
Korea Vehicle Loading	54
NATO Vehicle Loading	59
New Zealand Vehicle Loading	60
Norway Vehicle Loading	63
Poland Vehicle Loading	66
South Africa Vehicle Loading	67
Sweden Vehicle Loading	71
United Kingdom Vehicle Loading	81
United States of America Vehicle Loading	91
Moving Load Generator	105
Overview	105
Pedestrian Loading	109
Vehicle Load Optimisation	111
Performing a vehicle load optimisation analysis	111
Vehicle Load Optimisation Wizard	115
Design codes supported by LUSAS Traffic Load Optimisation	116
Australia AS5100-2:2004 to 2017 Loading	125
Australia AS5100-7:2004 (Austroads) Loading	130
Canada CAN/CSA-S6-06 (Design) Optional Code Settings	135
China JTG D60-2015 Optional Code Settings	139
Eurocode Traffic Loading	144
EN1991-2 Optional Code Settings	145
EN1991-2 Optional Code Settings - Denmark	151
EN1991-2 Optional Code Settings - Ireland	153
EN1991-2 Optional Code Settings - Italy	154
EN1991-2 Optional Code Settings - Norway 2010 + NA-rundskriv 07-2015	156
EN1991-2 Optional Code Settings - Poland	157

Application Manual (Bridge, Civil & Structural)

EN1991-2 Optional Code Settings - Recommended Values	157
EN1991-2 Optional Code Settings - Sweden.....	159
EN1991-2 Optional Code Settings - United Kingdom.....	162
EN1991-2 Optional Code Settings - Denmark.....	164
EN1991-2 Optional Code Settings - Ireland	166
EN1991-2 Optional Code Settings - Italy.....	167
EN1991-2 Optional Code Settings - Poland	169
EN1991-2 Optional Code Settings - Recommended Values	169
EN1991-2 Optional Code Settings - Sweden.....	170
EN1991-2 Optional Code Settings - United Kingdom.....	174
Finland LO 24/2014 - Optional Code Settings.....	175
Transit New Zealand Bridge Manual [SP/M/022 2nd Edition (2005), and 3rd Edition (2013)] Optional Settings	178
Saudia Arabia - MOMRA Optional Code Settings.....	181
South Africa - TMH7 Settings	185
Sweden - TDOK 2013:0267 Military Vehicles Optional Code Settings	187
Sweden - TDOK 2013:0267 Military Vehicles Advanced Settings.....	189
United Kingdom - BA34/90 Settings.....	190
United Kingdom - BD21/01 Optional Code Settings.....	194
United Kingdom - BD21/01 Annexes D and E Optional Code Settings	198
United Kingdom - BD37/01 Optional Code Settings.....	200
United Kingdom - BD86/11 Optional Code Settings.....	204
United Kingdom - BS5400-2:1978 Optional Code Settings.....	208
United States of America - AASHTO LRFD (7th Edition) Optional Code Settings.....	212
United States of America - AASHTO Standard Specifications (17th Edition) Optional Code Settings	222
Rail Load Optimisation.....	229
Performing a rail load optimisation analysis.....	229
Rail Load Optimisation Wizard.....	234
Design codes supported by Rail Load Optimisation (LUSAS RLO).....	234
Track Definition	240
Track Layouts.....	245
EN1991-2:2003 Optional Code Settings	247
UIC 776-1-R Optional Code Settings	252
NR-GN-CIV-025 Optional Code Settings	255
Design Combinations.....	259
Overview	259
Design Combination Options - AASHTO LRFD 8th.....	263
Design Combination Options - AASHTO LRFD 7th.....	266
Design Combination Options - AS/NZS 1170.....	269
Design Combination Options - BD21/01	270
Design Combination Options - BD37/01	271
Design Combination Options - CSA-S6-14	273
Design Combination Options - EN1990 - 2002 Bridges (Recommended Values).....	278
Design Combination Options - EN1990 - 2002 Bridges (UK National Annex).....	281
Design Combination Options - EN1990 - 2002 Buildings (Finland).....	284
Design Combination Options - EN1990 - 2002 Buildings (Ireland).....	287
Design Combination Options - EN1990 - 2002 Buildings (Italy)	289
Design Combination Options - EN1990 - 2002 Buildings (Norway).....	291
Design Combination Options - EN1990 - 2002 Buildings (Recommended Values).....	293
Design Combination Options - EN1990 - 2002 Buildings (Sweden).....	295
Design Combination Options - EN1990 - 2002 Buildings (UK)	297
Design Combination Options - GB 50009 - 2012	299
Design Combination Options - JTG D60-2004.....	300
Cable Tuning Analysis	301
Overview	301
Linear Cable Tuning Analysis	301

Nonlinear Cable Tuning Loadcase.....	306
Cable tuning: Solution types.....	309
Cable tuning: Defining the cables.....	312
Cable tuning: Defining the loadcases (linear cable tuning only).....	313
Cable tuning: Defining target values.....	315
Cable tuning: Optimisation criteria.....	316
Time Management.....	319
Overview.....	319
Prestress Loading.....	323
Overview.....	323
Defining Tendon Properties.....	326
Defining AASHTO LRFD 5th to 7th Edition Tendon Properties with losses based upon time inputs and calculated stresses.....	331
Defining EN 1992-1-1:2004 Eurocode 2 Tendon Properties with losses based upon time inputs and calculated stresses.....	335
Defining IRC:112-2011 Tendon Properties with losses based upon time inputs and calculated stresses.....	338
Defining AASHTO LRFD 2nd Edition Tendon Properties with approximate losses, requiring input of estimated stresses.....	341
Defining AASHTO LRFD 5th - 7th Edition Tendon Properties with approximate losses, requiring input of estimated stresses.....	343
Defining BS5400-4:1990 Tendon Properties with approximate losses, requiring input of estimated stresses.....	347
Defining DD EN1992-1-1:1992 Eurocode 2 Tendon Properties with approximate losses, requiring input of estimated stresses.....	348
Defining EN 1992-1-1:2004 Eurocode 2 Tendon Properties with approximate losses, requiring input of estimated stresses.....	352
Defining JTG D62-2004 Tendon Properties with approximate losses, requiring input of estimated stresses.....	355
Defining Tendon Profiles.....	357
Defining Tendon Loading.....	365
Tendon Loading Assignment.....	366
Tendon Prestress Loading Definition from a Spreadsheet.....	370
Rail Track-Structure Interaction Analysis.....	373
Overview.....	373
UIC774-3 Model Builder.....	374
UIC774-3 Rail Loads.....	376
UIC774-3 Post-Processor.....	377
Crack Width Calculation to EN 1992-1-1.....	379
Overview.....	379
Construction Tables.....	383
Overview.....	383
Construction Tables Explained.....	385
Steel Frame Design.....	389
Overview.....	389
Steel Frame Design - Code Selection.....	404
Steel Frame Design Attributes.....	405
Steel Frame Design Attribute Settings for AASHTO LRFD 7th (2014).....	408
Implementation Notes for Steel Frame Design Checks to AASHTO LRFD 7th (2014).....	412
Steel Frame Design Attribute Settings for AASHTO LRFD 8th (2017).....	417
Implementation Notes for Steel Frame Design Checks to AASHTO LRFD 8th (2017).....	422
Steel Frame Design Attribute Settings for AS4100.....	428
Implementation Notes for Steel Frame Design Checks to AS 4100.....	431
Steel Frame Design Attribute Settings for CSA-S6-14.....	432
Implementation Notes for Steel Frame Design Checks to CAN/CSA-S6-14.....	436
Steel Frame Design Attribute Settings for EN1993-1-1 and EN1993-2.....	437
Implementation Notes for Steel Frame Design Checks to EN1993-1-1 and EN1993-2.....	442

RC Slab Design.....	449
Overview	449
RC Slab Design : Design Code Settings and Parameters.....	450
Design Code Settings and Parameters for Australia (AS3600 / AS5100).....	452
Design Code Settings and Parameters for CAN/CSA-S6-06	455
Design Code Settings and Parameters for Europe (Eurocodes).....	464
Eurocode supported countries and their respective National Annexes	473
Design Code Settings and Parameters for India IRC:112-2011	474
Design Code Settings and Parameters for India (IRS:CBC-1997)	481
Design Code Settings and Parameters for Singapore (Eurocode / CP65-1999).....	487
Design Code Settings and Parameters for UK (Eurocode / British Standards).....	494
Design Code Settings and Parameters for AASHTO LRFD	502
Background to RC Slab Design Calculations.....	506
Viewing RC Slab Design results.....	509
Reinforced Concrete Frame Design	515
Overview	515
Carrying out a reinforced concrete frame design check	516
Specify RC frame design results required.....	518
Viewing RC frame design results	520
Adding RC frame design results to a model report.....	523
Section reinforcement.....	524
Line reinforcement	532
Concrete (Reinforced) Material Model	536
RC Frame Design - Code Selection	537
RC Frame Design Attributes	538
RC Frame Design Attribute Settings for EN1992-1-1: 2004 and EN1992-2: 2005.....	539
Implementation Notes for RC Frame Design Checks to EN1992-1-1 and EN1992-2	542
RC Frame Interaction Surface Diagrams	542
Tabulating RC Frame Design results for EN1992-1-1 and EN1992-2.....	545
Exporting data for Composite Deck Design.....	551
Overview	551
The Steel and Composite Deck Designer	554
Index.....	557

Introduction

Software Products Covered

This manual covers application-specific modelling and results facilities for LUSAS Bridge and LUSAS Civil & Structural software products.

Menu entries for these application products are inserted onto the main menu based upon the software key you have installed on your system or, if you are using LUSAS Academic software, by the selection of a software product during the set-up procedure. Some facilities for LUSAS Bridge and LUSAS Civil & Structural software products may also appear on the general LUSAS Modeller menu.

This manual describes the options available for the following menu items:

- Bridge menu**
- Civil menu**
- Design menu**

More detailed on-line help information on each of the application specific features described can be accessed from the Help button on the relevant dialog.

Bridge Menu

The Bridge menu item will appear between the Utilities and Window menu items. It provides access to the following bridge engineering specific facilities, according to the software product in use:

- Grillage Wizard** - Enables orthogonal, skewed and curved grillages to be generated from user-defined data.
- Precast Section** - Produces 2D cross-sectional models of country-specific precast concrete beams with or without a top slab.
- Box Section** - Calculate general box section properties from user defined dimensional data.
- Bridge Loading** - Gravity, Surface loading, and Static vehicle loads
- Moving Load** - Used to track the path of a static vehicle load (or a set of vehicles) across a structure
- Pedestrian loading wizard** - Used to generate the vertical pedestrian loading to supported design codes.

- ❑ **Vehicle Load Optimisation** - Identifies the most onerous vehicle loading patterns on bridges for a chosen design code.
- ❑ **Rail Load Optimisation** - Identifies the most onerous train loading arrangement for pre-defined track layouts for a supported design code.
- ❑ **Linear Cable Tuning Analysis** - Calculate load factors for selected lines in a model that represent cables in order to achieve defined target values set for various components or features
- ❑ **Time management** - Provides the means to manage a construction schedule. It can be used to easily update the total response time values in nonlinear and transient controls that have been previously specified for each loadcase of a staged construction analysis.
- ❑ **Prestress** - A legacy entry. Provides information on how to access the prestress loading facility.
- ❑ **Rail Track Analysis UIC 774-3** Enables track/structure interaction analysis to the International Union of Railways Code UIC774-3.
- ❑ **Crack Widths to EN1992-1-1** - Enables plotting of contours of design crack widths in accordance with the EN 1992-1-1 design code.
- ❑ **Construction Table** - Used to produce Camber, Displacement History, and Incremental Displacement tables of results for selected locations (points) on the model, and for any specified results loadcases

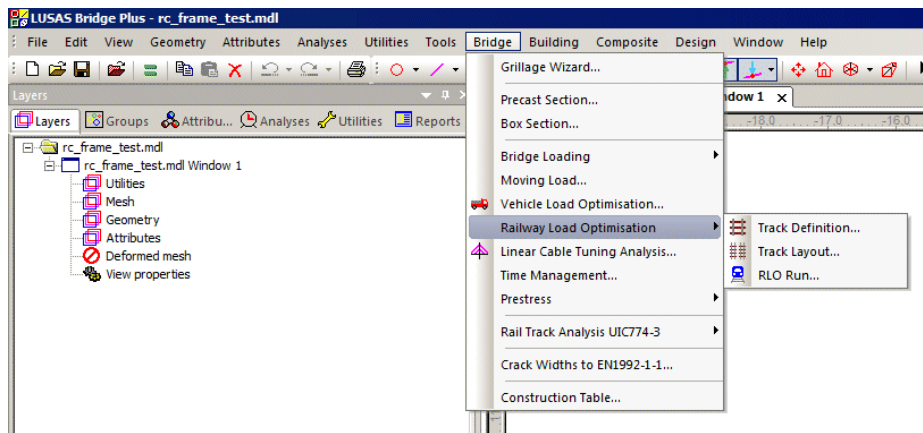

Civil Menu

The Civil menu item will appear between the Utilities and Window menu items. It provides access to the following civil / structural engineering specific facilities, according to the software product in use:

- ❑ **Precast Section** - Produces 2D cross-sectional models of country-specific precast concrete beams with or without a top slab.

- ❑ **Box Section** - Calculate general box section properties from user defined dimensional data.
- ❑ **Gravity** - Adds a body force loading attribute corresponding to gravity to the Attributes Treeview.
- ❑ **Linear Cable Tuning Analysis** - Calculate load factors for selected lines in a model that represent cables in order to achieve defined target values set for various components or features
- ❑ **Time management** - Provides the means to manage a construction schedule and easily adjust and update the duration times of construction stages in a staged construction analysis.
- ❑ **Prestress** - A legacy entry. Provides information on how to access the prestress loading facility.
- ❑ **Crack Widths to EN1992-1-1** - Enables plotting of contours of design crack widths in accordance with the EN 1992-1-1 design code.
- ❑ **Construction Table** - Used to produce Camber, Displacement History, and Incremental Displacement tables of results for selected locations (points) on the model, and for any specified results loadcases.

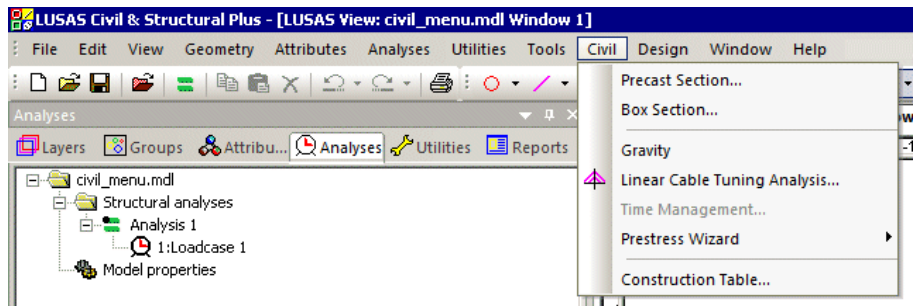

Availability of Bridge or Civil menu items according to software product.

Menu item	Bridge LT	Bridge	Bridge Plus	Civil LT	Civil	Civil Plus
Grillage Wizard	✓	✓	✓			
Precast Section		✓	✓		✓	✓
Box Section		✓	✓		✓	✓
Gravity				✓	✓	✓
Bridge Loading (inc gravity, and vehicle loads)	✓	✓	✓			
Moving Load	✓	✓	✓			
Vehicle Load Optimisation*	✓	✓	✓			
Rail Load Optimisation*	✓	✓	✓			
Construction Table		✓	✓			
Linear Cable Tuning Analysis		✓	✓		✓	✓
Time Management		✓	✓		✓	✓
Prestress Loading		✓	✓		✓	✓
Rail Track Analysis UIC 773-3*			✓			
Crack Width Calculation to EN1992-1-1		✓	✓		✓	✓
Construction Table		✓	✓		✓	✓

Note

- Vehicle Load Optimisation, Rail Load Optimisation and Rail Track Analysis UIC 773-3 are licenced software options and can only be accessed if the license key in use supports them.

Design Menu

The Design menu item will appear between the Bridge or Civil and Window menu items. It provides access to the following design code-specific facilities, according to the software product in use:

- RC Slab Design** - Enables the reinforcement required in slabs to be computed in accordance with chosen design codes.
- RC Frame Design** - Design code checking of regular and arbitrary shaped reinforced concrete decks/beams (and piers/columns) with or without voids due to bending with or without axial force can be carried out at the Ultimate Limit State (ULS) and Serviceability limit states (SLS) for a specified RC design code.

- ❑ **Steel Frame Design** - Design code checking of steel members for a chosen design code.
- ❑ **Steel Frame Design Results** - Design check results in tabular format for all or selected members in a model
- ❑ **Steel Frame Design Report** - A printable document showing design calculations carried out for a single particular member, calculations made, and referencing clauses and equations from the code.
- ❑ **Export to Composite Deck Design** - Export force and moment data from Modeller for selected sections, for use in design code checking by PontiEC4 software.
- ❑ **Design Combinations** - Generates load combinations according to codes of practice.

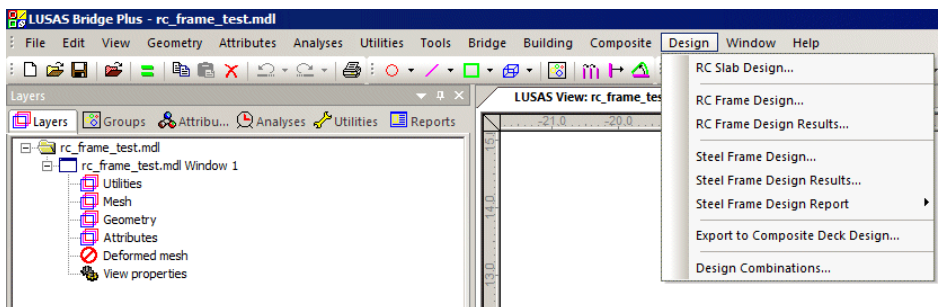

Availability of Design menu items according to software product.

Menu item	Bridge LT	Bridge	Bridge Plus	Civil LT	Civil	Civil Plus
RC Slab Design	✓	✓	✓	✓	✓	✓
RC Frame Design	✓	✓	✓	✓	✓	✓
Steel Frame Design	✓	✓	✓	✓	✓	✓
Steel Frame Design Summary	✓	✓	✓	✓	✓	✓
Steel Frame Design Report	✓	✓	✓	✓	✓	✓
Design Combinations	✓	✓	✓	✓	✓	✓
Export to Composite Deck Design	✓	✓	✓			

Note

- RC Frame Design and Steel Frame Design are licenced software options and can only be accessed if the licence key in use supports these products, the model's analysis category is 3D, and the analysis type is Structural. In all other cases the menu item will appear greyed-out.
- Steel / Composite Deck Design is a licenced software option that can only be accessed if the licence key in use supports it and the model's analysis category is 3D or 2D Grillage. The Export to Composite Deck Design option and the menu item will appear greyed-out if not available.

Grillage Wizard

Overview

The grillage wizard comprises a series of dialogs and enables orthogonal, skewed and curved grillages to be generated from user-defined data.

When creating a grillage model some basic guidelines should be considered:-

- Grillage wizard models are created with one line mesh division for each grillage element. Additional line mesh attributes can be created and assigned to the model should this ever prove to be required.
- Longitudinal grillage members should be placed along lines of design strength. For a slab model this could be where there was a concentration of reinforcement in the slab itself. For a composite bridge this could be at the location of a steel girder / prestress beam.
- The aspect ratio between the length of the transverse and longitudinal members should be set so that a good static distribution of loading is achieved. An aspect ratio of 1 to 1 is normally used but an aspect ratio of up to 1 to 3 is acceptable.
- Whenever possible it is recommended that a grillage model should have supports located at the intersection of longitudinal and traverse members.
- The grillage wizard automatically places rigid supports onto the model at bearing locations. These supports can be overwritten with new attributes of, say, an elastomeric bearing using a spring support. The supports should be chosen to as closely represent the actual structure as possible.
- If the results from a coarse grillage are in doubt for any reason a more refined grillage should be used to check the results.

Grillage Wizard : Step 1 - Grillage Type



- Select the type of grillage model that you require. Both slab deck and spaced beam with slab deck constructions are supported and cracked section may be included.
- Spaced beam and slab deck models will automatically have elements defined for the allocation of cracked properties. By default 15% of the span (over internal supports) will be assumed to be cracked but this can be modified if required.
- The wizard accounts for multiple spans and applies support conditions. Groups are created to enable geometric and material properties to be easily assigned.

Grillage Wizard : Step 2 - Straight or Curved Deck

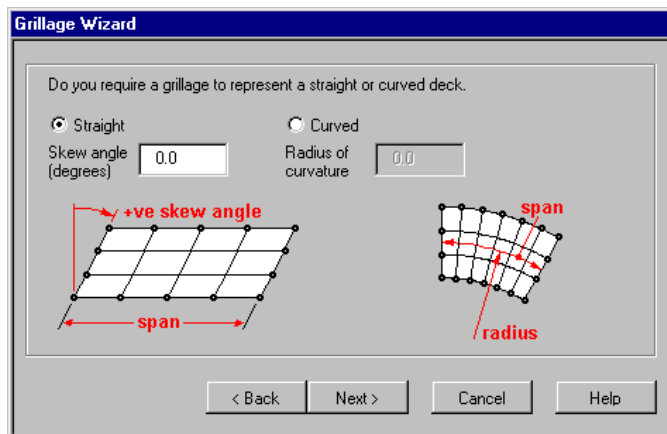

- Select whether a straight grillage or curved grillage is required. For a straight grillage a skew angle can be set. For a curved grillage a radius of curvature needs to be entered.
- For a straight grillage if any angle other than zero is entered, when the **Next** button is selected a dialog allowing a skewed or orthogonal transverse beam arrangement will be shown.

Grillage Wizard : Step 2a - Skewed or Orthogonal Beams

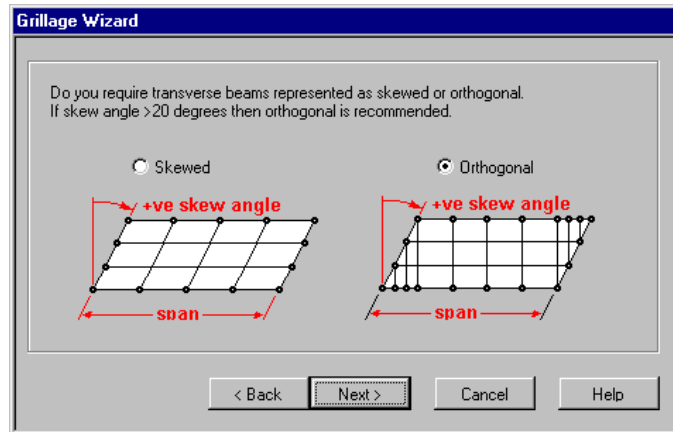

- If an angle has been entered for a straight grillage the geometry can be formed from skewed grillage elements or orthogonal grillage elements.
- If the skew angle is above 20 degrees then an orthogonal arrangement is recommended.

Grillage Wizard : Step 3 - Longitudinal Beam Detail

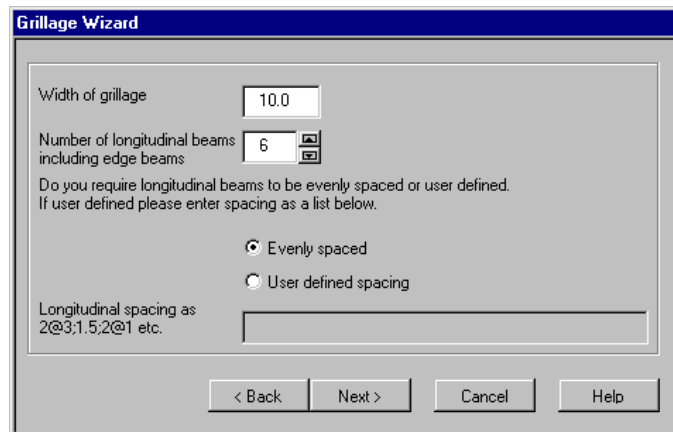

- The width of the grillage and the number of longitudinal beams can be set on this dialog
- The longitudinal beams can be evenly spaced or a user defined spacing can be set up allowing if services troughs dictate this is necessary.

Grillage Wizard : Step 4 - Span Details

The screenshot shows the 'Grillage Wizard' dialog box, Step 4 - Span Details. The dialog is titled 'Grillage Wizard' and contains the following settings:

Number of spans	Span 1					Span 2					Span 3					Span 4					Span 5				
Length of span	20.0					30.4					10.0					10.0					10.0				
Number of internal transverse beams	9					6					9					9					9				
Length of span	Span 6					Span 7					Span 8					Span 9					Span 10				
Length of span	10.0					10.0					10.0					10.0					10.0				
Number of internal transverse beams	9					9					9					9					9				

At the bottom of the dialog, there are four buttons: '< Back', 'Finish', 'Cancel', and 'Help'.

- The number of spans, their lengths and the number of transverse elements can be set on this dialog.
- Clicking the **Finish** button creates the grillage model of the previously specified values

Section generators and property calculators

In addition to the range of generally available standard section property calculators and the arbitrary section property calculator the following are available from the Bridge (or Civil) menu:

- Precast Beam Section Generator**
- Box Section Property Calculator**

Precast Beam Section Generator

The Precast Beam Section Generator is provided in Bridge and Civil & Structural software products only. It produces 2D cross-sectional models of country-specific precast concrete beams with a top slab. These models are typically used to calculate beam section properties for use in grillage and frame models.

Precast concrete beam sections (with a slab) can be defined for the following countries:

- UK beams: Y, YE, TY, TYE, SY, M, UM and U beam types**
- US beams: AASHTO Types II to VI, Florida Bulb T72 and T78 beams, NU Girders and Texas DoT 'T' Girders, Northeast Bulb 'T'**
- Australia and New Zealand beams: Super-T beams T1 to T5 (open and closed)**
- Canada 'T' beams**

Note that these precast beam sections (of beams without a top slab) and other common shapes are held in the general [section library](#) for the countries stated. They can be accessed using the **Attributes > Geometric > Section Library** menu item.

Creating and saving a section

The Precast Beam Section Generator is accessed from the **Tools> Section Property Calculator> Precast Section** menu item.

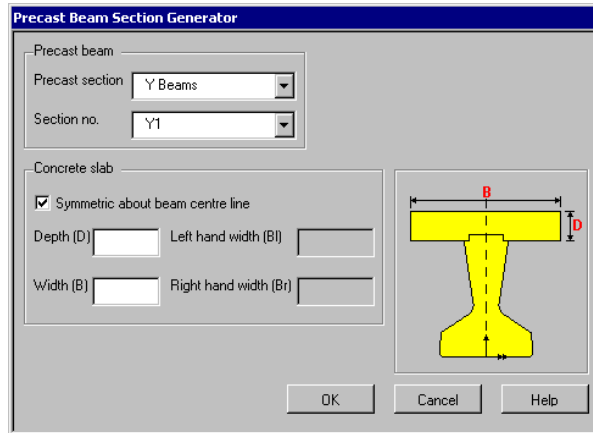

Precast beam

- Precast section** allows selection of a range of precast beam types.
- Section no** allows selection of a particular beam type.

Concrete slab

- Symmetric about beam centre line** option, if ticked, creates a slab of a width that is centred about the beam centre. If unchecked, left and right hand widths for the slab can be entered.
- Depth** and **Width** of top slab is required.

Once valid dimensions are specified and the **OK** button is pressed the defined section is drawn to the screen.

Calculating section properties

The arbitrary section property calculator must be used to calculate a full set of section properties for the shape and to save the section to a user-defined local or server library. Use the **Tools> Section Property Calculator> Arbitrary Section** menu item to do this.

Using a section

To add the generated precast beam and geometry to the Attributes  treeview select the **Attributes> Geometric> Section Library** menu item, select **User Sections**, then

select **Local** or **Server** before choosing the section required from the list available. The geometric properties can then be **assigned** to the required Line(s) in the model.

Notes:

- Differences in concrete strengths between the beam and the slab are not considered. However, this can be emulated by altering the width and/or depth of the slab as required.
- Super-T precast sections are based upon Roads and Traffic Authority of NSW Drawing Number RTAB033 Issue 8 Jan 2007 entitled: “Standardisation of Super-T Girder Sections”.

Box Section Property Calculators

The Box Section Property Calculator is provided in Bridge and Civil & Structural software products only. It is accessed from the **Tools> Section Property Calculator > Box Section...** menu item or from the Bridge menu.

The box section property calculators calculate general section properties from user defined dimensional data. The section shape can be defined either as a **simple box section** or as a **complex box section** created from as many points as are required to form a suitable representation of the true cross-sectional shape. A void can be included or excluded from a section. The sections generated are of a type typically used in precast and segmentally constructed bridges.

General section properties (area, moments of inertia and torsion constant etc.) of the section are computed automatically once a valid set of dimensions have been defined, using model units. Extreme fibre positions for use when plotting stresses on beams are also calculated. The resulting section can additionally be:

- Visualised to check for correct values being entered and to see the automatically defined fibre locations
- Converted into model geometry. This would typically be used, for example, if it was required to modify the generated section in some way inside LUSAS Modeller before re-calculating the new section properties of the edited section using the **Arbitrary Section Property Calculator**.
- Added to a local or server library to enable the section properties to be used on the current project or on other projects.

Note: The Box Section Property Calculator does not currently calculate the additional section properties (such as shear centres, warping, radius of gyration, plastic properties etc.) that are required for use with design calculations. Instead, after defining a section shape, the **Create geometry** button should be used to draw the section prior to using

the **Arbitrary Section Property Calculator** which will calculate the full set of section properties for the shape.

Simple Box Section

The simple box section calculator creates a box section of the style shown from user-defined values. No fillets can be specified internally when a void is present.

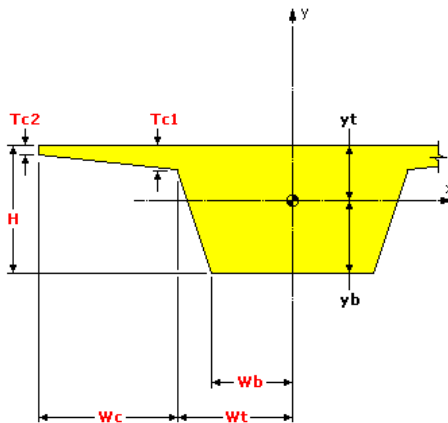
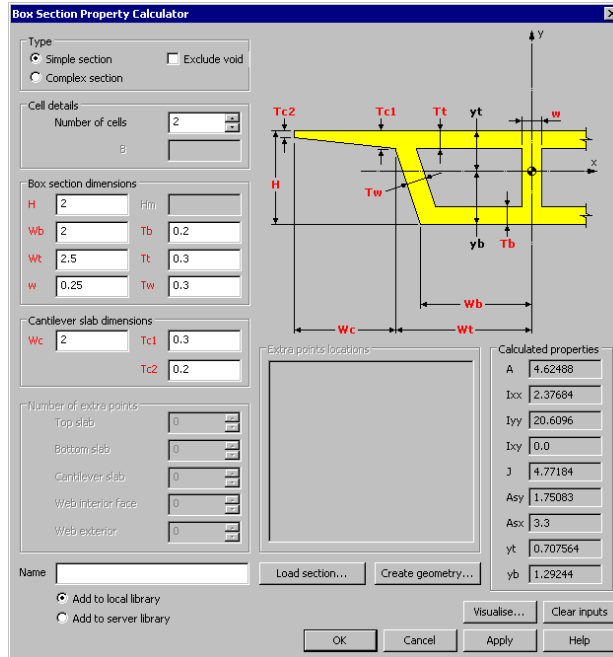

Simple box section without void

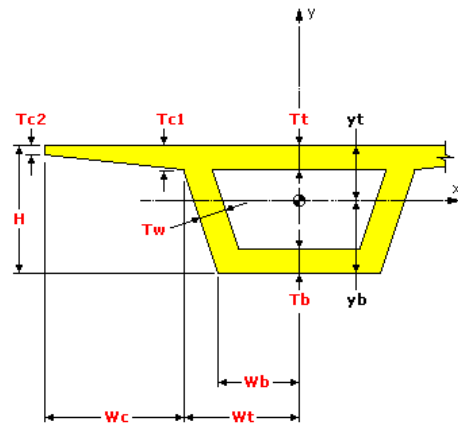

One cell simple box section

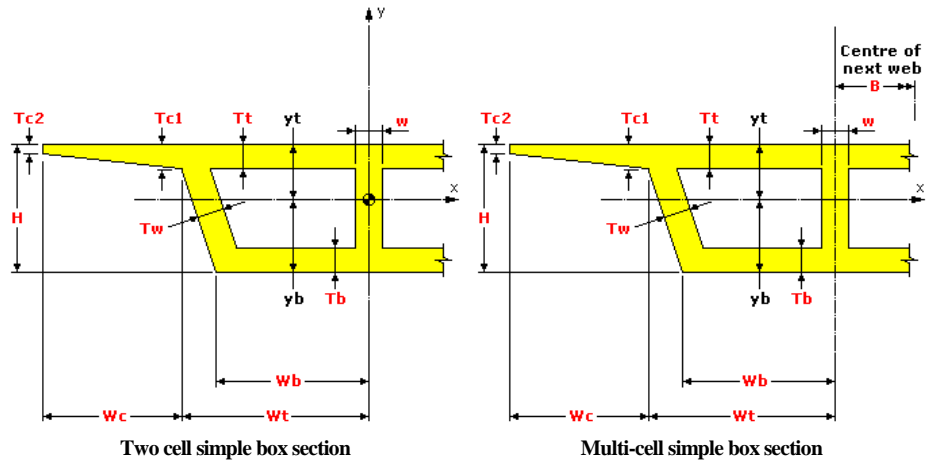

Dimensional data:

- Cell details** Specify the number of cells, and the spacing between centre to centre distances of webs
- Box section dimensions** These specify the overall height and width of the box, and the thicknesses of top and bottom slabs and side walls.
- Cantilever slab dimensions** These specify the width and thickness of the cantilever.

Saving and using the defined section:

- The **Name** of the section must be entered.
- Add to local library** Adds the calculated values to the local library when the Apply or OK button is selected.
- Add to server library** Adds the calculated values to the server library when the Apply or OK button is selected.
- Load section...** Displays a list of previously created and saved cross-sections that can be re-selected to populate the fields of the dialog. The list displayed is for the local or server library that is set.
- Clear inputs** Clears any entered or populated data.
- Create geometry** Creates a 2D LUSAS model from the dimensional data. This would typically be used, for example, if it was required to modify the generated section in some way inside LUSAS Modeller before re-calculating the new section properties of the edited section using the **Arbitrary Section Property Calculator**. Additional options are available to position or orientate the section geometry that is created in a view window. By default a section created has its centre of gravity set at the view origin, that is 0,0,0.
- Section details...** Shows the calculated properties and the cross-section that has been defined by the entered data. It also shows the fibre locations that are automatically created. Note that the axes shown on the visualisation are view

axes. An additional option to add a picture of this visualised section to the Annotation layer is provided. Select Create Annotation to do this.

- Use the **Apply** button to save a section to a library and continue to modify values or define another section using the same dialog. Use the **OK** button to save the defined section and close the dialog.

Using a defined simple box section

To use the computed section properties in a model the section must have been saved to a local or server library.

To add a library item to the Attributes  treeview select the **Attributes> Geometric> Section Library** menu item, then select **User Sections**, then select **Local** or **Server** before choosing the section required from the list available. The geometric properties can then be **assigned** to the required Line(s) in the model. If the section shape is constant over a line feature a direct assignment to a line can be made. If the section shape varies over a line feature a set of pre-defined box sections can be used with the **Multiple Varying Sections** facility to create a multiple varying section line attribute for assignment to a line or lines on a model.

Complex Box Section

The complex box section calculator creates a box section of the style shown from user-defined values and as many additional points as are required to form the cross-sectional shape. A camber in the top slab can be optionally created for one and two celled sections. Fillets can be specified internally when a void is present.

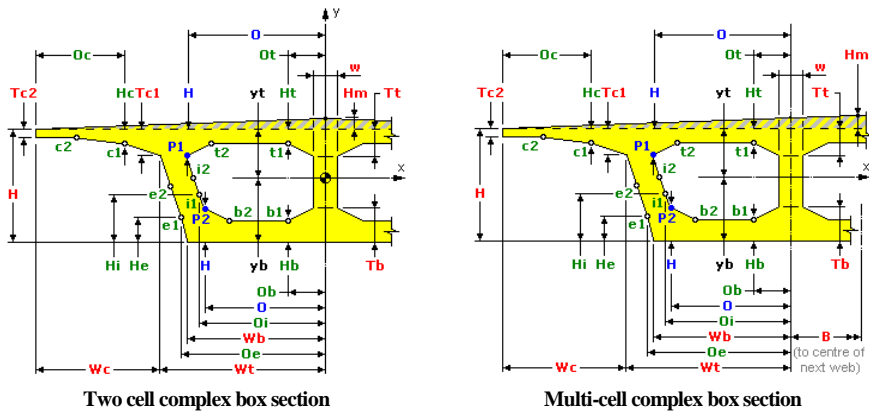

Dimensional data:

- Cell details** Specify the number of cells, and the spacing between centre to centre distances of webs
- Box section dimensions** These specify the overall height and width of the box and the thicknesses of the top and bottom slabs.
- Cantilever slab dimensions** These specify the width and thickness of the cantilever.
- No of extra points** These allow for any number of additional points to be defined in specified areas of the cross-section in order to accurately represent the true section shape. When extra points are added, additional dimensional data must be entered in the Points panel of the dialog.

Saving and using the defined section:

- The Name** of the section must be entered.
- Add to local library** Adds the calculated values to the local library when the Apply or OK button is selected.
- Add to server library** Adds the calculated values to the server library when the Apply or OK button is selected.
- Load sections...** Displays a list of previously created and saved cross-sections that can be re-selected to populate the fields of the dialog. The list displayed is for the local or server library that is set.
- Clear inputs** Clears any entered or populated data.
- Create geometry** Creates a 2D LUSAS model from the dimensional data. This would typically be used, for example, if it was required to modify the generated section in some way inside LUSAS Modeller before re-calculating the new section properties of the edited section using the **Arbitrary Section Property Calculator**. Additional options are available to position or orientate the section geometry that is created in a view window. By default a section created has its centre of gravity set at the view origin, that is 0,0,0.

- Section details...** Shows the calculated properties and the cross-section that has been defined by the entered data. It also shows the fibre locations that are automatically created. Note that the axes shown on the visualisation are view axes. An additional option to add a picture of this visualised section to the Annotation layer is provided. Select Create Annotation to do this.
- Use the **Apply** button to save a section to a library and continue to modify values or define another section using the same dialog. Use the **OK** button to save the defined section and close the dialog.

Defining a complex box section

The main box cell, section and cantilever setting out dimensions for a complex box section are shown dimensioned with a height (H), width (W), slab thickness (T) and in the case of three or more celled sections, a breadth, (B). Slab thickness specifies the thickness of the slab at the location shown on the section dialog. Note that on multi-celled box sections, dependent upon the thickness specified, this may represent the distance from the top of the slab to the bottom of an internal fillet (Tt) or the distance from the bottom of the slab to the top of an internal fillet (Tb). In addition to these primary dimensions extra points can be defined to model a particular box section shape. Some extra points are mandatory as in the case of points P1 and P2. Others such as t1, b1, e1, i1, c1 etc. are optional.

Notes on defining a complex box section

- Points P1 and P2 define the extent of the interior face of the external web. These points must be defined in the Extra Points grid in all cases, even when no fillets are required. Points P1 and P2 will lie at the corners of a void if no fillets are specified.
- Additional points can be defined to either model a particular cantilever shape, a side wall shape or to model simple fillets at top or bottom slab locations. Selecting the location and number of the points required in the No. of extra points cell will add fields to the Extra Points grid to allow offsets (O) and heights (H) for these points to be defined. As an example, to define fillets at the junction of the upper slab and the side and internal walls of a two cell box section, two internal points in the Top slab drop-down list would need to be specified (t1 and t2) in addition to specifying a thickness (Tt) from the top of the slab to the bottom of the fillet. Defining fillets for the lower slab/wall connections would be similar. See the Complex Box Section Examples for details.
- To model a curving external box section profile as many points on the web exterior face and cantilever slab can be defined as necessary to approximate the actual profile.
- A camber in the top slab can be optionally created by entering a value for the height of the midpoint of the slab (Hm).

Complex Box Section Examples

These examples show which extra points must be specified in addition to all other dimensions shown on the dialog in order to obtain the section shape shown. A two-cell box with no camber in the top slab is shown. The definition of extra points for single and multiple box sections is similar.

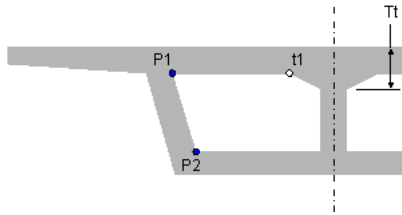

Upper slab fillet to internal wall only

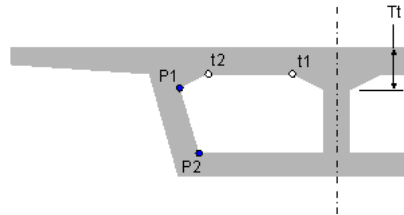

Upper slab fillet to all walls in section

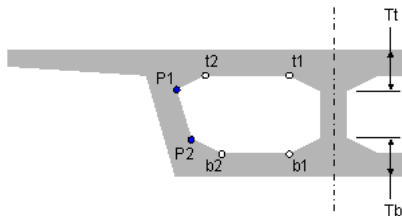

Upper and lower slab fillet to all walls

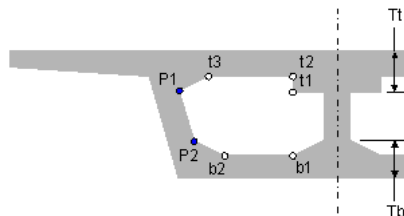

Custom connection to upper slab

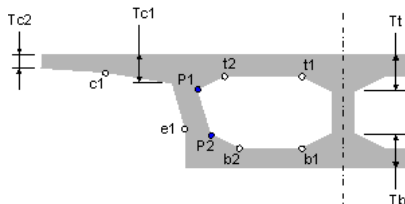

Use of extra points to define outer wall and cantilever soffit

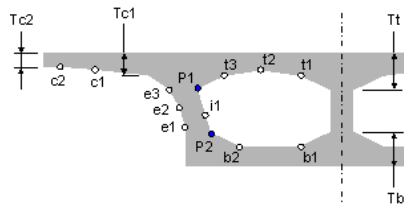

Use of multiple extra points

Complex section extra points explained

Extra points	Description	Mandatory / Optional
P1, P2	Define the extent of the interior face of the outer walls	Mandatory
t1, t2, t3...	Define upper slab fillets.	Optional
b1, b2, b3...	Define lower slab fillets	Optional
e1, e2, e3...	Define the shape of the external face of the outer walls	Optional
i1, i2, i3...	Define the shape of the interior face of the outer walls	Optional
c1, c2, c3...	Define cantilever soffit shape	Optional

Using a defined box complex box section

To use the computed section properties in a model the section must have been saved to a local or server library.

To add a library item to the Attributes  treeview select the **Attributes > Geometric > Section Library** menu item, then select **User Sections**, then select **Local** or **Server** before choosing the section required from the list available. The geometric properties can then be **assigned** to the required Line(s) in the model. If the section shape is constant over a line feature a direct assignment to a line can be made. If the section shape varies over a line feature, a set of pre-defined box sections can be used with the **Multiple Varying Sections** facility to create a multiple varying section line attribute for assignment to a line or lines on a model.

Infilled / Encased Section Property Calculator

The Infill/Encased Section Property Calculator is provided in Bridge and Civil & Structural software products only and can be accessed from the **Tools > Section Property Calculator > Infill/Encased Section...** menu item. It allows you to define the section geometry for a range of infilled or encased section types either with reference to sections held in the main section library, or from user-defined values, for saving into a section library. Note that at the time of definition, only illustrative section properties can be calculated for the section based upon a user-defined modular ratio for the two different materials that can be defined. The actual section properties can only be determined when chosen materials have been assigned to the section either as part of selecting it from a section library and adding a section to the Attributes  Treeview, or when assigning the section to features in a model .

Section types available

The following sections are supported via the Type drop-down:

- Filled box

- Filled stiffened box
- Filled pipe
- Filled stiffened pipe
- Encased hollow box - with rectangular or circular encasement
- Encased filled box - with rectangular or circular encasement
- Encased hollow pipe - with rectangular or circular encasement
- Encased filled pipe - with rectangular or circular encasement
- Encased I-beam - with rectangular or circular encasement
- Encased Cross I-beam - with rectangular or circular encasement
- Encased Combined-T-beam - with rectangular or circular encasement

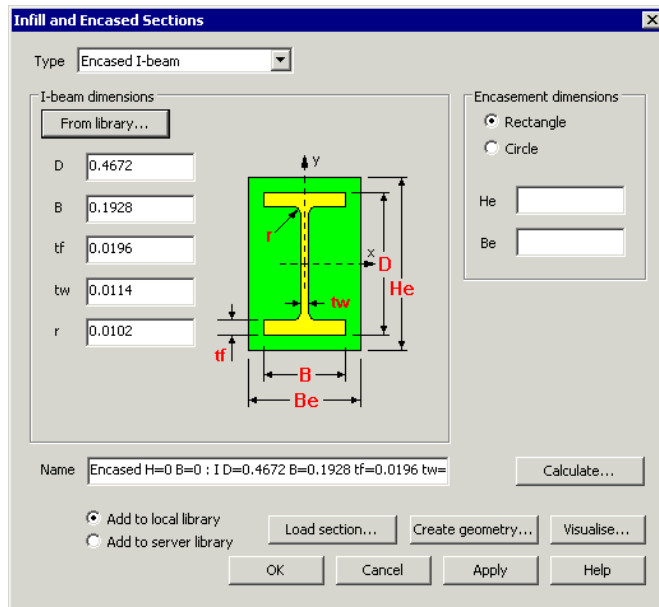

Typical infill/encased section property calculator dialog

Specifying section dimensions

- Steelwork section dimensions can be entered manually, or sections can be imported from the section library (if a section of the specified type is available in the library) using the **From library...** button.

Encasement dimensions

- Encasement dimensions can be stated for either a **rectangular** or **circular** encasement. The encased member will be centred within the casement values stated.

Other options

- The section **Name** is built up from entered values and is created once the last valid defining value has been entered. It can be renamed if desired although it is recommended that the default name is generally used.
- Section details...** Shows illustrative section properties for the section based upon a user-defined modular ratio for the different materials. These properties are not retained when the section is saved to a section library. The actual section properties can only be determined when materials have been assigned to the section either as part of adding a section to the Attributes  Treeview, or when assigning the section to features in a model. A black cross and section axis is drawn at the centroid of the section. A magenta filled circle represents the location of the nodal line about which the section will be positioned when the section is assigned to a line on the model. Fibre locations that are automatically created for extreme positions within each quadrant are also shown. An additional option to add a picture of this visualised section to the Annotation layer is provided. Select Create Annotation to do this.
- Load section...** Displays a list of previously created and saved cross-sections that can be re-selected to populate the fields of the dialog.
- Create geometry** Creates a 2D LUSAS model from the dimensional data. This would typically be used if it was required to modify the generated section in some way inside LUSAS Modeller before re-calculating the new section properties of the edited section using the **Arbitrary Section Property Calculator**. Additional options are available to position or orientate the section geometry that is created in a view window.
- Add to local library** Adds the section type and section dimensions to the local library when the Apply button is selected. The local library is located in the current project directory.
- Add to server library** Adds the section type and section dimensions to the server library when the Apply button is selected.
- Note that section property calculation does not currently calculate the additional section properties required for use with design calculations. Instead, after defining a section shape, the **Create geometry** button should be used to draw the section prior to using the arbitrary section property calculator to calculate the full set of section properties for the shape. Note that the additional properties required for design calculations are not required for a general analysis to be carried out.

Using infilled or encased sections

To use an infilled/encased section in a model the section must be saved to a local or server library. To add a library item to the Attributes  Treeview select the **Attributes> Geometric> Section Library** menu item, then select **User Sections**, then select **Local** or **Server** before choosing the section required from the list available. Pressing OK creates the attribute, which can then be **assigned** to the required Line(s)

in the model. Material properties will need to be assigned to the section either as part of adding a section to the Attributes  Treeview, or when assigning the section to features in a model.

Notes

Infill/Encased section cannot be used in tapering or multiple varying section definitions.

Plate Section Property Calculator

The Plate Section Property Calculator is provided in Bridge and Civil & Structural software products only and is accessed from the **Tools> Section Property Calculator > Plate Sections...** menu item. It allows definition of section geometry for a range of riveted or welded section types, either with reference to sections held in the main section library or from user-defined values, for saving into a section library.

Section types available

The following sections are supported via the Type drop-down:

- Riveted I section**
- Riveted box section**
- Riveted trough**
- Riveted box from I sections**
- I section with channel**
- Riveted box from channels (back to back)**
- Riveted box from channels (face to face)**
- I section with doubler plates**
- Welded plate box**
- Riveted T section**
- Riveted cruciform**

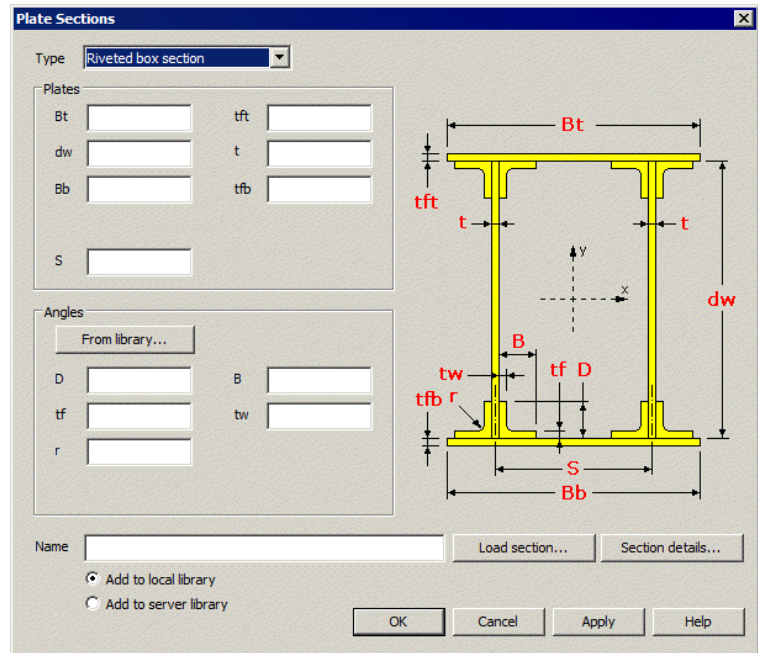

Typical plate section property calculator dialog

Specifying section dimensions

- Steelwork section dimensions can be entered manually, or for particular sections, sections can be imported from the section library using the **From library...** button.



Other options

- The section **Name** is built up from entered values and is created once the last valid defining value has been entered. It can be renamed if desired although it is recommended that the default name is generally used.
- Section details** This button is used to generate section properties for the section, and a visualisation of the cross-section defined by the entered data. A black cross and section axis is drawn at the centroid of the section. A magenta filled circle represents the location of the nodal line about which the section will be positioned when the section is assigned to a line on the model. Fibre locations that are automatically created for extreme positions within each quadrant are also shown. An additional option to add a picture of this visualised section to the Annotation layer is provided. Select Create Annotation to do this.
- Load section...** Displays a list of previously created and saved cross-sections that can be re-selected to populate the fields of the dialog.

- Add to local library** Adds the section type and section dimensions to the local library when the Apply button is selected. The local library is located in the current project directory.
- Add to server library** Adds the section type and section dimensions to the server library when the Apply button is selected.

Using plate sections

To use a plate section in a model the section must be saved to a local or server library.

To add a library item to the Attributes  Treeview select the **Attributes> Geometric> Section Library** menu item, then select **User Sections**, then select **Local** or **Server** before choosing the section required from the list available. Pressing OK creates the attribute, which can then be **assigned** to the required Line(s) in the model. Material properties will need to be assigned to the section either as part of adding a section to the Attributes  Treeview, or when assigning the section to features in a model.

Notes

Plate sections cannot be used in tapering or multiple varying section definitions.

Bridge Loading

Overview

Bridge loading types are accessed from the **Bridge > Bridge Loading** menu item.

The following bridge loading types and facilities are available:

- Gravity**
- Surfacing Loading**
- Static Vehicle Loads**

Gravity Loading

By selecting the **Bridge or Civil > Gravity** menu item a body force loading attribute is added to the Attributes  Treeview.

Gravity loading is defined in accordance with the vertical axis direction that was specified either initially on the New Model dialog or subsequently on the Vertical Axis dialog accessed using the **Tools > Vertical Axis** menu item.

Gravity loading may also can be defined as a property of an analysis or loadcase, or by manually specifying a constant body force load.

Surface Loading

Surface loading can be defined by selecting the **Bridge > Bridge Loading > Surfacing** menu item.

Surface loading is computed for each lane from the density and thickness of the surfacing material. The density is defined in t/m^3 and the dimension of the lane and thickness of the surfacing are defined in metres. The surface loading is then computed in the units selected initially on the New Model dialog.

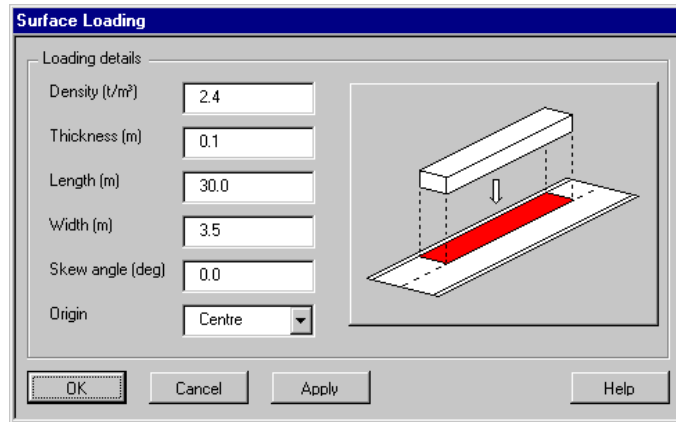

To use this loading type:

- **Density** - specifies the density of the surfacing in t/m^3
- **Thickness** - specifies the thickness of the surfacing
- **Length** - specifies the length of the surfacing
- **Width** - specifies the width of the surfacing
- **Skew angle** - specifies the skew angle
- **Origin** - specifies the origin of the surfacing load to be used to position the loading on the structure.

Static Vehicle Loads

Static vehicle loading types are accessed from the **Bridge > Bridge Loading** menu item.

A number of dialogs are available to simplify the input of bridge loading in accordance with regional codes of practice. These are continually being extended and currently include:

- Australia**
- Canada**
- China**
- Denmark**
- Eurocode**
- Finland**
- India**
- Israel**

- [Korea](#)
- [NATO](#)
- [New Zealand](#)
- [Norway](#)
- [Poland](#)
- [South Africa](#)
- [Sweden](#)
- [United Kingdom Vehicle Loading](#)
- [United Kingdom Train Loads](#)
- [United Kingdom Special Vehicle Loads](#)
- [United States of America](#)

Using static vehicle loadings

Vehicle loadings have a loading origin at their centre and, when relevant, have a direction of travel shown or stated on the dialog from which they are created.

Once a vehicle load type is selected or defined, discrete point and/or patch load attributes are added to the Attributes  Treeview. For some loading types a compound discrete loading attribute (which comprises a set of discrete point or patch loads to define a loading type) may also be created to represent the static vehicle loading. The required discrete point, patch or compound loading must then be assigned to a point on a model (which need not form part of the model itself). During assignment a patch transformation can be used to mirror, rotate or otherwise transform the discrete patch load that represents the vehicle, to obtain a desired orientation of loading.

Notes

- Vehicle loads are defined in relation to the currently set Vertical axis (as set using the Tools > Vertical Axis menu item). The longitudinal direction of the vehicle definition is assumed to be along the X-axis, unless the X axis is vertical in which case the vehicle load will be defined along the Y axis. The vehicle is assumed to move forwards in the positive longitudinal direction.
- A moving load generator can be used to track the path of a static vehicle load (or a compound set of vehicle loads) across a structure. See [Moving Loads](#) for details.
- As an alternative to using static vehicle loads, vehicle load optimisation software can be used to automatically identify the most onerous vehicle loading patterns on bridges for a supported design code and to apply these loading patterns to LUSAS models. See [Vehicle Load Optimisation Explained](#) for details.

- It should be noted that specifying a **direction definition** to set the vertical, longitudinal and transverse axes for a model to assist with model orientation and the calculation of particular effect does not apply to static vehicle loadings created from the Bridge > Bridge Loading menu.

Australia Vehicle Loading

Australian vehicle loads are defined to the AUSTRROADS Bridge Design Code HB77.2, AS 5100-2: 2004 : Bridge design - Design loads and AS 5100-7: 2004 : Bridge design - Rating of existing bridges.

See [Using static vehicle loadings](#) for general details regarding static vehicle loadings.

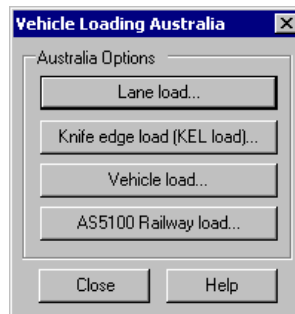

Australia Lane Loads

The lane load generator produces a uniform patch load based on nominal lane width, loaded length and intensity. The lane load intensity is set to a default value but this can be modified to any value required.

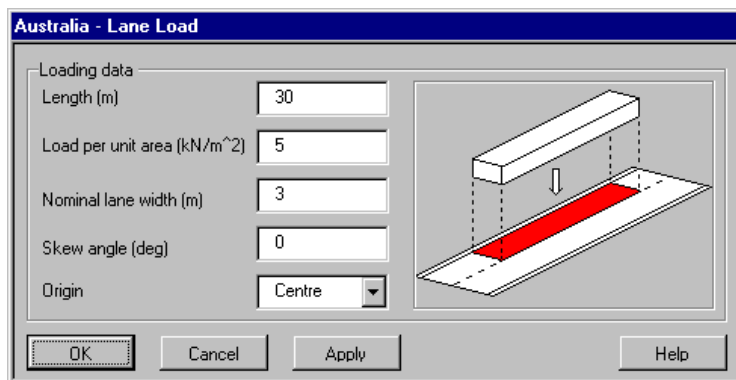

To use this loading type:

- Specify the loaded length.

- Specify the load per unit area.
- Specify the nominal lane width.
- Specify the skew angle to apply to the lane loading (clockwise positive).
- Choose the origin about which the load is to be generated.

Australia Knife Edge Loads (KEL) Loads

The KEL load generator produces a knife-edge load based on notional lane width and intensity. The intensity of the knife-edge load is set to a default value but can be modified to any value required.

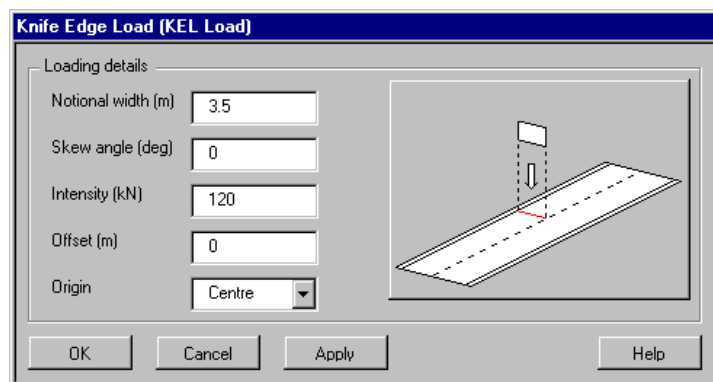

To use this loading type:

- Specify the notional width.
- Specify the skew angle to apply to the lane loading (clockwise positive).
- Specify the intensity.
- Specify the offset (longitudinal).
- Choose the origin about which the load is to be generated.

Australia Vehicle Load

For the vehicle loads the following truck types can be created: T44, HLP320, HLP400, W80, A160, M1600 and S1600.

For the truck types T44, HLP320, HLP400, M1600 and S1600 the variable axle spacing, L, can be set to the required value.

For the truck types M1600 and S1600 the vehicle load and the accompanying patch can also be created.

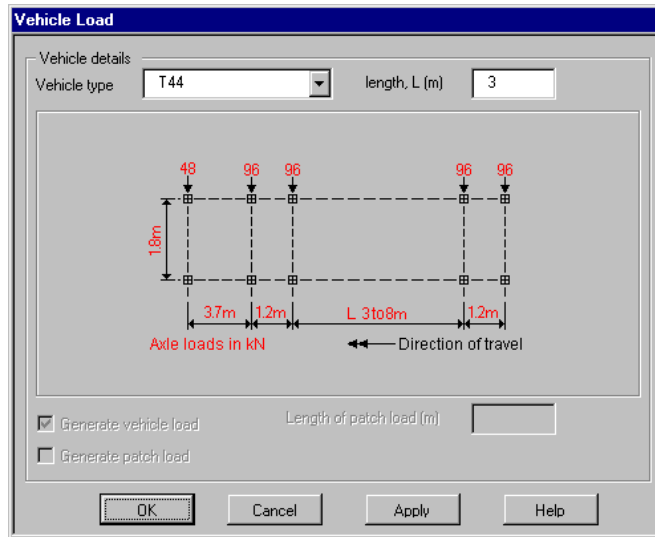

To use this loading type:

- Choose the vehicle type, and if necessary specify a value for the length.

Australia AS5100 Railway Loading

Australia Railway Traffic loading is accessed from the Australia Vehicle Loading dialog:

Three rail vehicle configurations are supplied to Australia Vehicle Loading in accordance with AS5100-2 representing vehicle 300LA, 300-A-12 and 300-A-12 (Single Axle). The 300LA vehicle is defined in accordance with the current standard and is the default. Vehicle 300-A-12 is added for assessment carried out in accordance with AS5100-7 “Bridge Design – Rating of Existing Structures.”

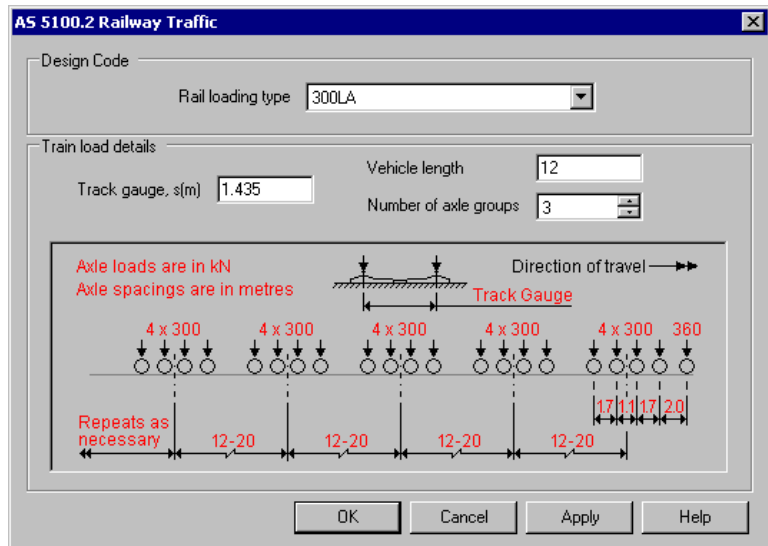

- ❑ **Rail loading type** Loading type 300LA is defined in accordance with AS5100-2 and is the default choice. Loading type 300-A-12 is for assessment carried out in accordance with AS5100-7 “Bridge Design – Rating of Existing Structures.” Loading type 300-A-12 (Single Axle) provides a pair of loads equal to half the stated axle load.
- ❑ **Track gauge** Set to 1.435m, but can be user-defined.
- ❑ **Vehicle length** (for loading type 300LA only). Set to 12 by default.
- ❑ **Number of axle groups** Set to 3 by default

Canada Vehicle Loading

Canadian vehicle loads are defined to the Canadian Highway Bridge Design Code (CHBDC.)

See [Using static vehicle loadings](#) for general details regarding static vehicle loadings.



Canada Lane Loads

The lane load generator produces a uniform patch load based on the nominal lane width, loaded length and intensity. The lane load intensity is set to a default value but this can be modified to any value required.

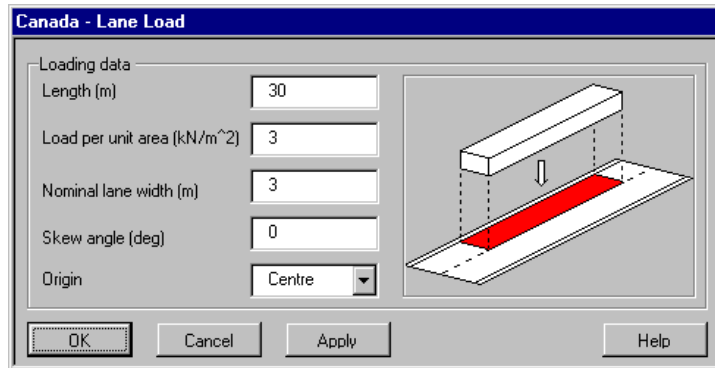

To use this loading type:

- Specify the loaded length.
- Specify the load per unit area.
- Specify the nominal lane width.
- Specify the skew angle to apply to the lane loading (clockwise positive).
- Choose the origin about which the load is to be generated.

Canada Vehicle Load

For the vehicle loads the following types can be created: CL1-625, CL2-625, CL3-625, CL1-800, CL2-800, CL3-800 and CHBDC Maintenance. The load intensity may be reduced to 80% for use with lane loading and the Ontario variations are provided.

The vehicle loads represent the CL-W truck. Two vehicle weights are available: 625 and 800. Three variations of each vehicle weight can be selected, namely, CL1, CL2 and CL3, representing five, four and three axles of the CL-W truck respectively. The load intensity of each vehicle may be reduced to 50% for use with lane loading and the Ontario variations of CL-625 truck are provided. The maintenance vehicle is defined in fig 3.4 of the design code is also available.

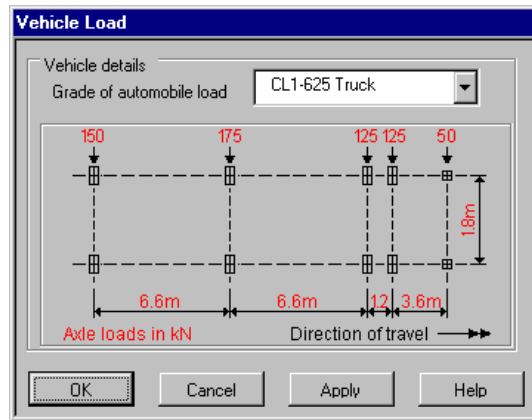

China Vehicle Loading

Chinese vehicle loads are defined to the JTG D60-2004 General Code for Design of Highway Bridges and Culverts.



China Lane Loads

The lane load generator produces a uniform patch load based on notional lane width, loaded length and grade of automobile loading (Highway I, Highway II and Highway II – fourth grade). The intensity of the patch is calculated based on the loaded length entered with shorter loaded lengths having higher intensity.

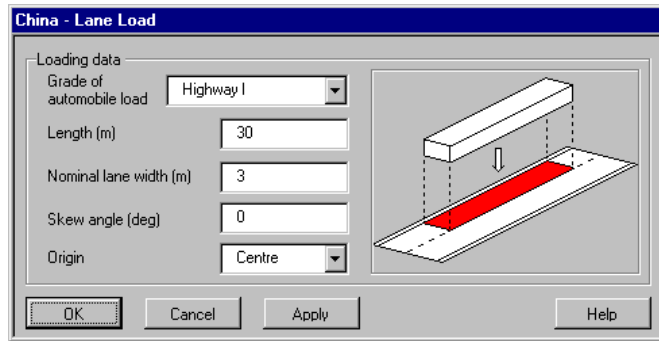

To use this loading type:

- Choose the grade of automobile load.
- Specify the length of loading.
- Specify the nominal lane width.
- Specify the skew angle to apply to the lane loading (clockwise positive).
- Choose the origin about which the load is to be generated.

China Knife Edge Loads (KEL) Loads

The KEL load generator produces a knife-edge load based on notional lane width and intensity. The intensity of the knife-edge load has a default value set but can be modified to any value required.

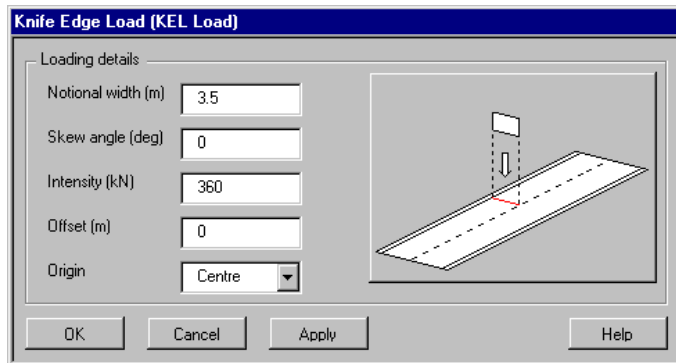

To use this loading type:

- Specify the notional width.
- Specify the skew angle to apply to the lane loading (clockwise positive).

- Specify the load intensity.
- Specify the offset.
- Choose the origin about which the load is to be generated.

China Vehicle load

The vehicle load generator produces truck loads based on grade of automobile loading (Highway I, Highway II and Highway II – fourth grade).

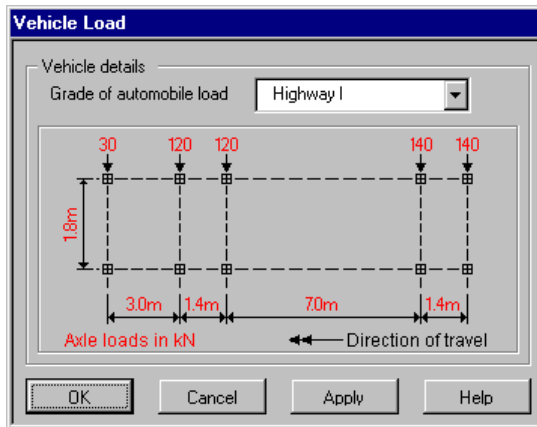

To use this loading type:

- Choose the grade of automobile required.

Denmark Vehicle Loading

Denmark vehicle loads are defined in accordance with the special vehicles defined as Load Model 3 (LM3) in the Danish National Annex to EN1991-2. This comprises 22 vehicles of fixed axle weight and spacing that are denoted as “Type 1” and a further 8 vehicles that are denoted as “Type 2” for assessment purposes.

See [Using static vehicle loadings](#) for general details regarding static vehicle loadings.

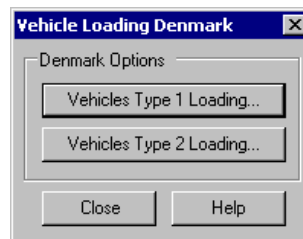

Denmark Vehicle Type 1 Loading

Vehicle type can be selected from a range that extends from Class 10 to Class 500. A shock factor can be optionally specified for a particular span length.

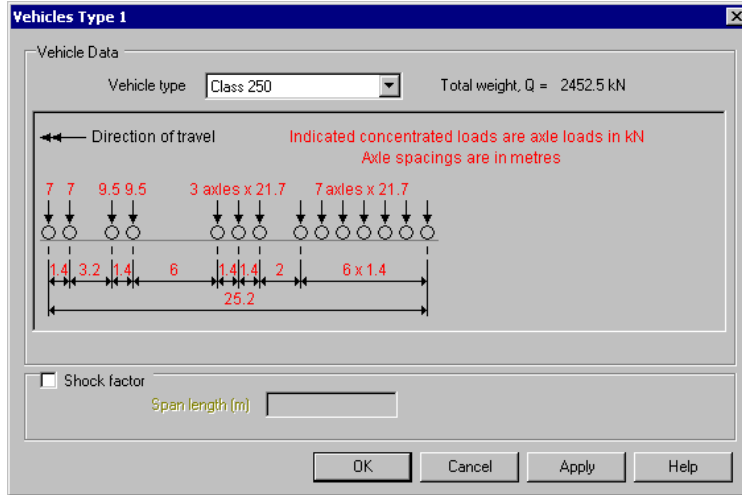

To use this loading type:

- Choose the vehicle type from the drop down list.
- Specify an optional Shock factor for a specified span length.

Denmark Vehicle Type 2 Loading

Vehicle type can be selected from a range that extends from 16 Tonnes to 48 Tonnes, with the 24 Tonnes and 32 Tonnes options including a two or three-wheeled trailer.

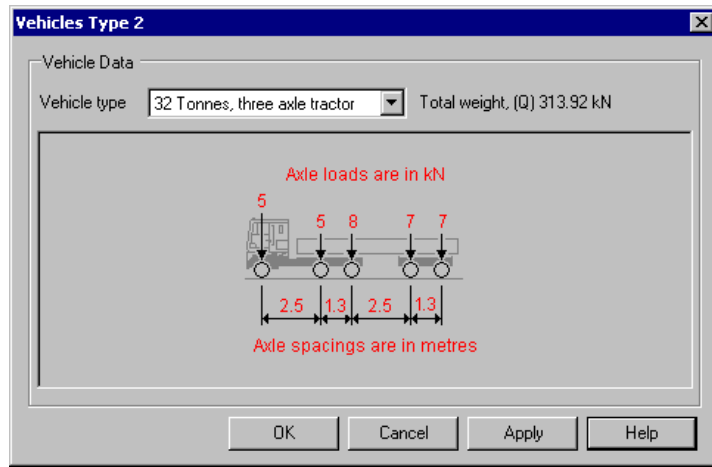

To use this loading type:

- Choose the vehicle type from the drop down list.

Eurocode Vehicle Loading

Eurocode vehicle loads are defined to EN1991-2:2003 Eurocode 1: Actions on structures - Part 2: Traffic loads on bridges. Note that any country-specific load models (incorporated as part of a country's National Annex to EN1991-2:2003) are documented in the static vehicle load types for that country.

See [Using static vehicle loadings](#) for general details regarding static vehicle loadings.

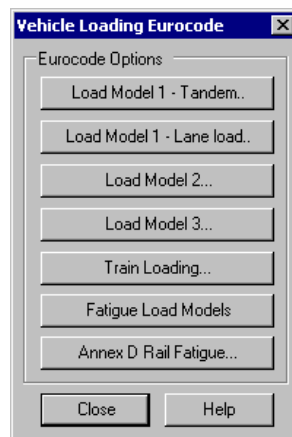

Eurocode Load Model 1 (LM1) - Tandem

The Load Model 1 (LM1) - Tandem load generator produces a tandem system load comprising two axles of intensity 300kN, 200kN and 100kN, for use in Lane numbers 1, 2 and 3 as defined by the design code.

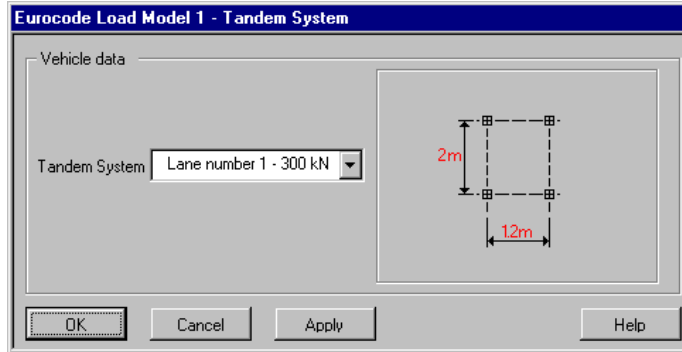

To use this loading type:

- Choose the tandem system from the drop down list.

Eurocode Load Model 1 (LM1) - Lane load

The Load Model 1 (LM1) – Lane load generator produces a uniform patch load based on loaded length and required intensity (9kN/m² and 2.5kN/m²).

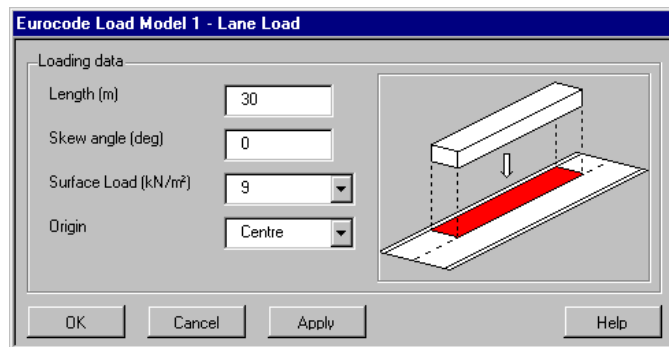

To use this loading type:

- Specify the length of lane load.
- Specify the skew angle to apply to the lane loading (clockwise positive).
- Choose the surface load.
- Choose the origin about which the load is to be generated about.

Eurocode Load Model 2 (LM2)

The Load Model 2 (LM2) load generator produces a single axle load of 400kN.

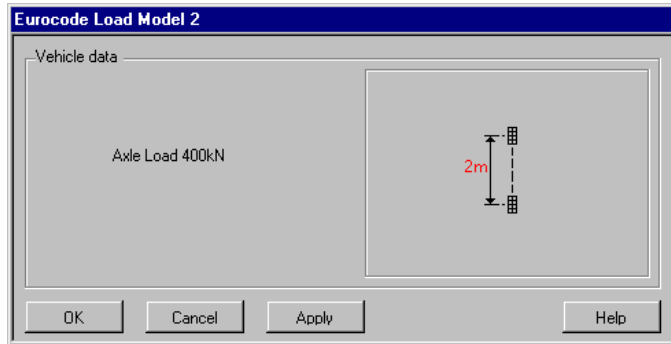

Eurocode Load Model 3 (LM3)

The Load Model 3 (LM3) load generator produces the following special vehicle loads, as defined in Annex A: 600/150, 900/150, 1200/150, 1200/200, 1500/150, 1200/200, 1800/150, 1800/200, 2400/200, 2400/240, 2400/200/200, 3000/200, 3000/240, 3000/200/200, 3600/200, 3600/240 and 3600/200/200.

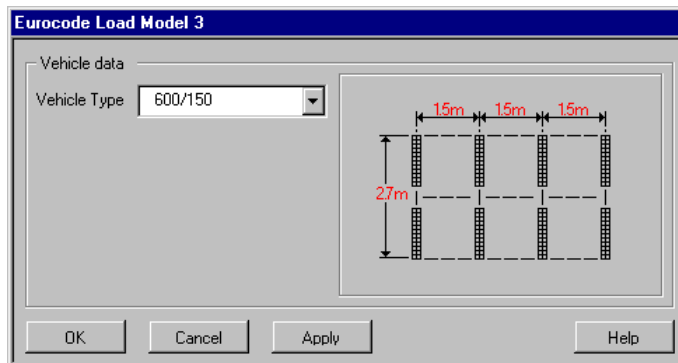

To use this loading type:

- Choose the special vehicle from the drop down list.

Classes of Special Vehicles

Total weight	Composition	Notation
600 kN	4 axle-lines of 150 kN	600/150
900 kN	6 axle-lines of 150 kN	900/150
1200 kN	8 axle-lines of 150 kN	1200/150
	or 6 axle-lines of 200 kN	1200/200
1500kN	10 axle-lines of 150 kN	1500/150
	or 7 axle-lines of 200 kN + 1 axle line of 100 kN	1500/200
1800 kN	12 axle-lines of 150 kN	1800/150
	or 9 axle-lines of 200 kN	1800/200
2400 kN	12 axle-lines of 200 kN	2400/200
	or 10 axle-lines of 240 kN	2400/240
	or 6 axle-lines of 200 kN (spacing 12m) + 6 axle-lines of 200 kN	2400/200/200
3000 kN	15 axle-lines of 200 kN	3000/200
	or 12 axle-lines of 240 kN + 1 axle-line of 120 kN	3000/240
	or 8 axle-lines of 200 kN (spacing 12 m) + 7 axle-lines of 200 kN	3000/200/200
3600kN	18 axle-lines of 200 kN	3600/200
	or 15 axle-lines of 240 kN	3600/240
	or 9 axle-lines of 200 kN (spacing 12 m) + 9 axle-lines of 200 kN	3600/200/200

Eurocode Train Loading

Eurocode train loading is accessed from the Eurocode Vehicle Loading dialog:

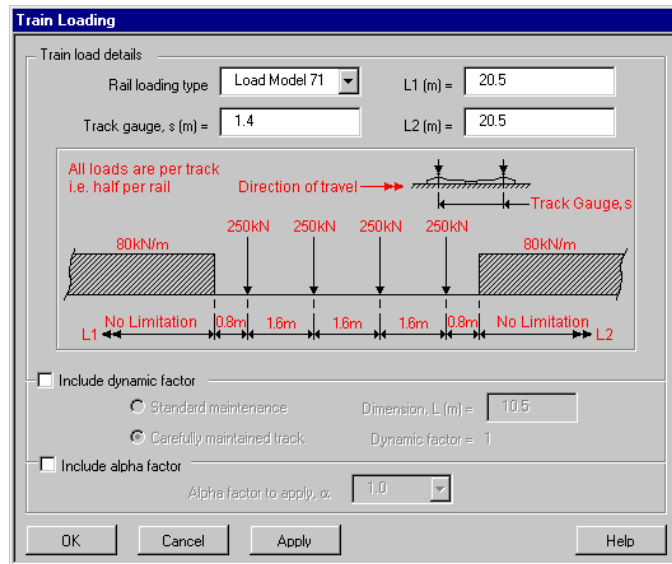

- Rail loading type** Standard railway loading consists of Load Model 71, and Load Model SW/0 (for continuous bridges) to represent normal rail traffic on mainline railways and Load Model SW/2 to represent heavy loads. HSLM-A1 to A10 and HSLM-B loadings are High Speed Load Model (HSLM) to EN1991-2:2003. Section 6.4.6.
 - Load Model 71 represents the static effect of vertical loading due to normal rail traffic. It consists of four 250kN concentrated loads preceded, and followed, by a uniformly distributed load of 80kN/m.
 - Load Model SW/0 represents the static effect of vertical loading due to normal rail traffic on continuous beams. It consists of two uniformly distributed loads of 133kN/m, each 15m long and separated by a distance of 5.3m.
 - Load Model SW/2 represents the static effect of vertical loading due to heavy rail traffic. It is similar to SW/0 Loading, however, the uniformly distributed loads are 150kN/m, each 25m long and separated by a distance of 7m.
 - HSLM-A1 to A10 vehicles comprise a series of coaches of varying length and axle weights pulled by a standard power car. This load type is only applicable when carrying out a dynamic analysis.
 - HSLM-B loading varies depending on the supplied span length and is applicable for simply supported short spans of less than 7m. This load type is only applicable when carrying out a dynamic analysis.

- Track gauge** must be entered in metres and has to be 1.4m or greater.

- ❑ **L1 and L2** are entered as appropriate for the load model chosen, as indicated on the dialog diagram. All dimensions are in metres.
- ❑ **Dynamic factor** The dynamic factor is applicable to Load Models 71, SW/0 and SW/2 and allows for impact, oscillation and other dynamic effects including those caused by track and wheel irregularities. The dynamic factor takes account of the dynamic magnification of stresses and vibration effects in the structure but does not take account of resonance effects. The factor used will vary according to determinant length (L) and whether the track receives standard maintenance or is carefully maintained. In deriving the dynamic factor, L is taken as the length (in m) of the influence line for deflection of the element under consideration. For non-symmetrical influence lines, L is twice the distance between the point at which the greatest ordinate occurs and the nearest end point of the influence line. In the case of floor members 3m should be added to the length of the influence line as an allowance for load distribution through track
- ❑ **Alpha factor** The characteristic values of Load Model 71 and SW/0 Loading shall be multiplied by a factor α , on lines carrying rail traffic which is heavier or lighter than normal rail traffic (Clause 6.4.5). When multiplied by the factor the loads are called “classified vertical loads” (Clause 6.3.2(3)).

Eurocode Fatigue Load Models

Eurocode Fatigue Load Model loading is accessed from the Eurocode Vehicle Loading dialog:

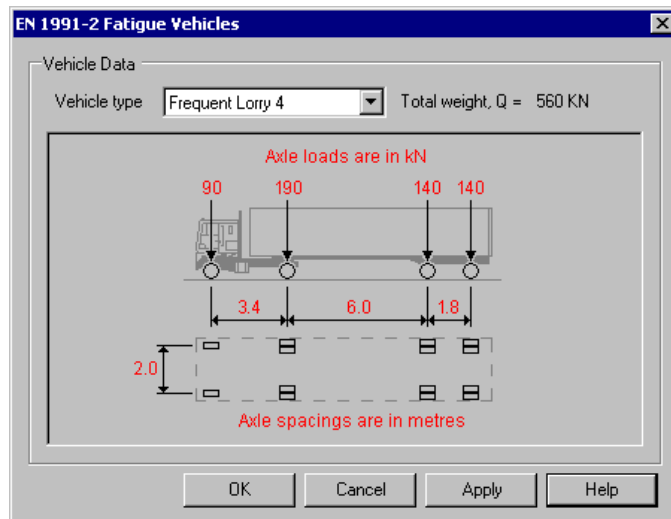

- ❑ **Vehicle type** Highway fatigue vehicles for Fatigue Load Models 2, 3 and 4 in accordance with section 4.6 of EN1991-2.

- **Frequent Lorry (1 to 5)** Set of "frequent lorries" for Fatigue Load Model 2.
- **LM3 Single vehicle** Four axle loading in accordance with Fatigue Load Model 3.
- **Standard Lorry (1 to 5)** Set of "standard lorries" for Fatigue Load Model 4.

Eurocode Annex D Rail Fatigue Vehicles

Eurocode Rail Fatigue Vehicle loading is accessed from the Eurocode Vehicle Loading dialog:

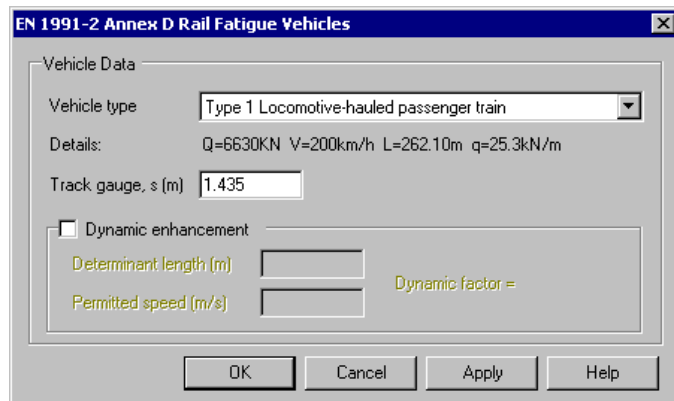

- **Vehicle type** Rail fatigue vehicles in accordance with EN1991-2 Annex D. The rail fatigue vehicles comprise twelve different train type and loading arrangements.
 - **Type (1-12)** Set of twelve rail fatigue vehicles.
 - **Track gauge** Set to 1.435m but can be user-defined.
 - **Dynamic enhancement** Applies a dynamic factor to the static vehicle description. The dynamic factor is calculated from the determinant length and permitted speed in accordance with Annex D.1.

Finland Vehicle Loading

Finland vehicle loads are defined to the Finnish loading design code TIEL 2172072-99 and the National Annex EN1991-2

See [Using static vehicle loadings](#) for general details regarding static vehicle loadings.

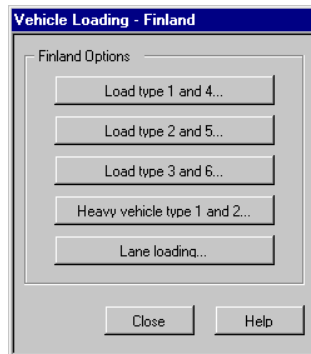

Finland Load Types 1 and 4

The load generator for load types 1 and 4 produces vehicle loads based on the selection of Type 1 or 4. The variable axle spacings can be set to the required distance.

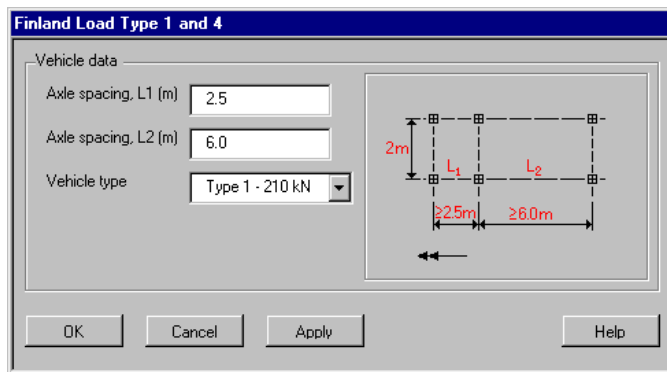

To use this loading type:

- Specify the axle spacings for L1 and L2. Note that L1 has to be greater than 2.5m and L2 greater than 6m.
- Choose the vehicle type from the drop down list.

Finland Load Types 2 and 5

The load generator for load types 2 and 5 produces vehicle loads based on the selection of Type 2 or 5.

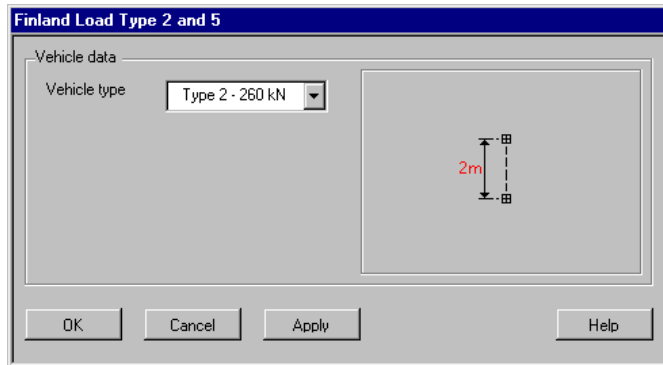

To use this loading type:

- Choose the vehicle type from the drop down list.

Finland Load Types 3 and 6

The load generator for load types 3 and 6 produces vehicle loads based on the selection of Type 3 or 6.

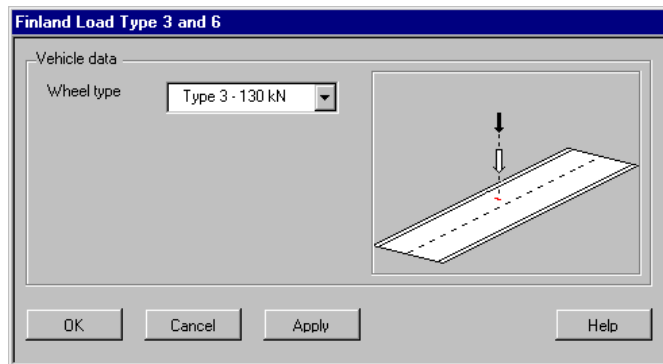

To use this loading type:

- Choose the vehicle type from the drop down list.

Finland Heavy Vehicle Types 1 and 2

The load generator for heavy vehicle types 1 and 2 produces vehicle loads based on the selection of Type 1 or 2. The variable axle spacings can be set to the required distance.

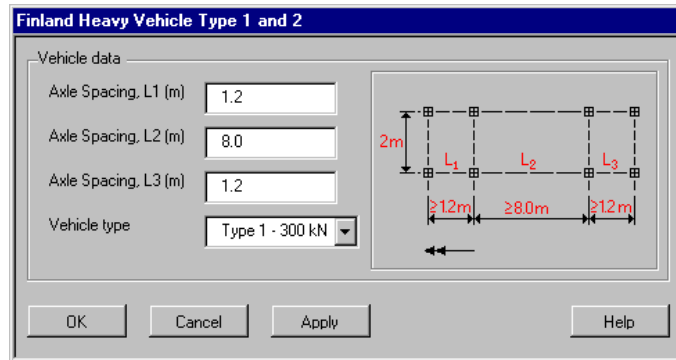

To use this loading type:

- Specify the axle spacings for L1, L2 and L3. Note that L1 and L3 must be greater than 1.2m, and L2 greater than 8m.
- Choose the vehicle type from the drop down list.

Finland Lane Loads

The lane load generator produces a uniform patch load based on loaded length and intensity. The intensity of the lane load is taken from Class 1 or Class II of Load Model 1. The lane width is 3m.

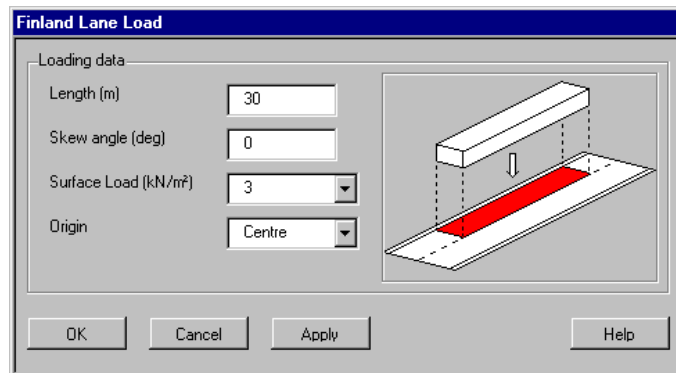

To use this loading type:

- Specify the length of lane load that you require to generate about the centre line of patch.
- Specify the skew angle to applied to the lane loading (clockwise positive).
- Choose the surface load intensity from the drop down list.

- Choose the origin that the load will be generated about.

EN 1991-2-Finland LM3

Special vehicle loading as defined as Load Model 3 (LM3) in the Finnish National Annex to EN1991-2. The loading comprises two patch loads separated by a stated distance (Clause 4.3.4).

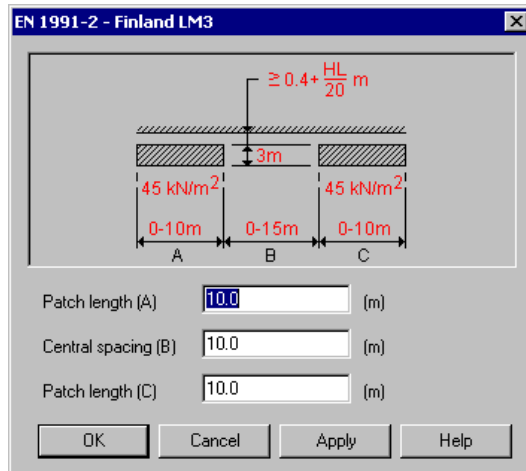

To use this loading type:

- Specify the patch length and central spacing.

India Vehicle Loading

Indian vehicle loads are defined to IRC:6-2000 Section: II Loads and Stresses.

See [Using static vehicle loadings](#) for general details regarding static vehicle loadings.



India Lane Load

The Lane load generator produces a uniform patch load based on loaded length and notional lane width. The option to include crowd load can be added to the loading.

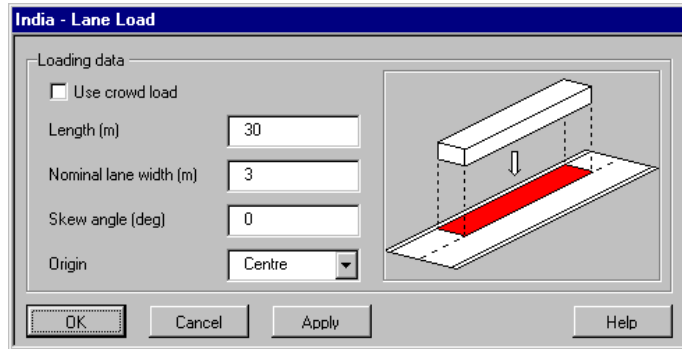

To use this loading type:

- Choose **Use crowd load** if applicable.
- Specify the length of lane load.
- Specify the nominal lane width in metres
- Specify the skew angle to apply to the lane loading (clockwise positive).
- Choose the origin about which the load is to be generated.

India Tracked Load

The tracked load generator produces the following tracked vehicle loads: AA, 5R, 9R, 12R, 18R, 24R, 30R, 40R, 50R, 60R and 70R.

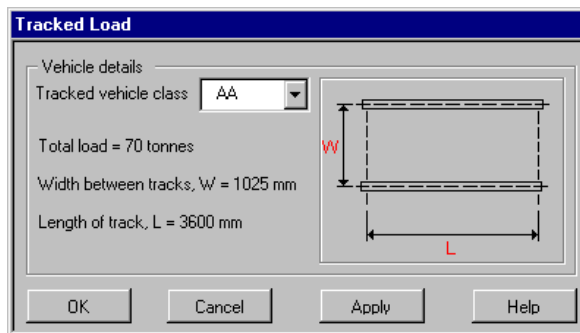

To use this loading type:

- Choose the tracked vehicle class.

India Vehicle Load

The India load generator produces the following vehicle loads: 3, 5R, 9R, 12R, 18R, 24R, 30R, 40R, 50R, 60R, 70R A, B and AA. Each of these vehicles can have many different configurations by setting the number of axles and wheels.

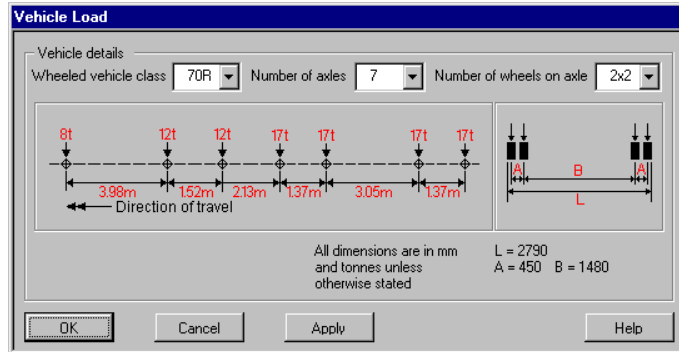

To use this loading type:

- Choose the wheeled vehicle class.
- Choose the number of axles.
- Choose the number of wheels on the axle.

Israel Vehicle Loading

Israel vehicle loads are defined to the Israeli loading design code.

See [Using static vehicle loadings](#) for general details regarding static vehicle loadings.



Israel Lane Load (HA Loads)

The HA load generator produces a uniform patch load based on notional lane width and loaded length. The intensity of the patch is calculated based on the loaded length entered with shorter loaded lengths having higher intensity

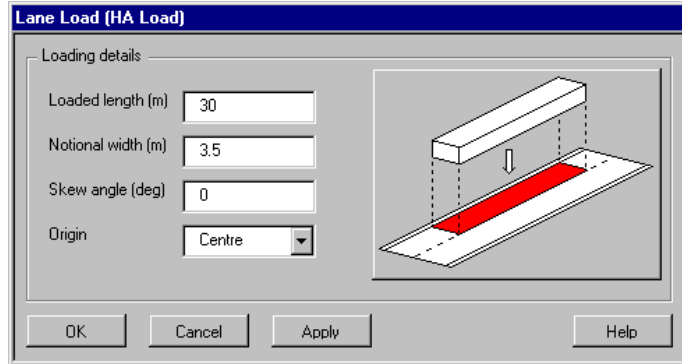

To use this loading type:

- Specify the loaded length.
- Specify the notional width.
- Specify the skew angle to apply to the lane loading (clockwise positive).
- Choose the origin about which the load is to be generated.

Israel Knife Edge Load (KEL Loads)

The KEL load generator produces a knife-edge load based on notional lane width and intensity. The intensity of the knife-edge load has a default value set but this can be modified to any value required.

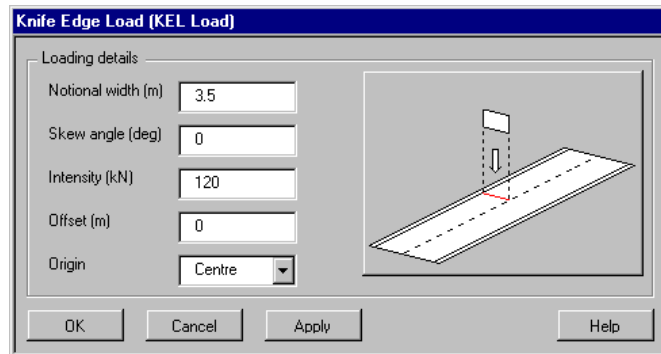

To use this loading type:

- Specify the notional width.
- Specify the skew angle to apply to the lane loading (clockwise positive).
- Specify the intensity
- Specify the offset.
- Choose the origin about which the load is to be generated.

Israel Abnormal Load Generator (HB Vehicle)

The HB load generator produces a HB vehicle by setting the inner axle spacing (8m, 13m, 18m, & 23m).

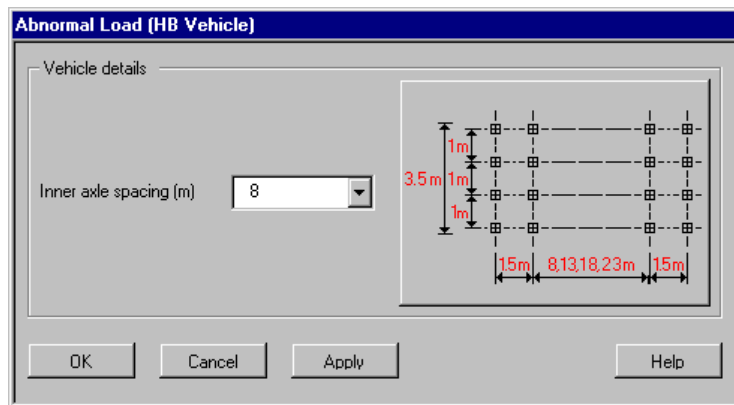

To use this loading type:

- Choose the inner axle spacing.

Israel Abnormal Load Generator (HC Vehicle)

The HC load generator produces a HC vehicle.

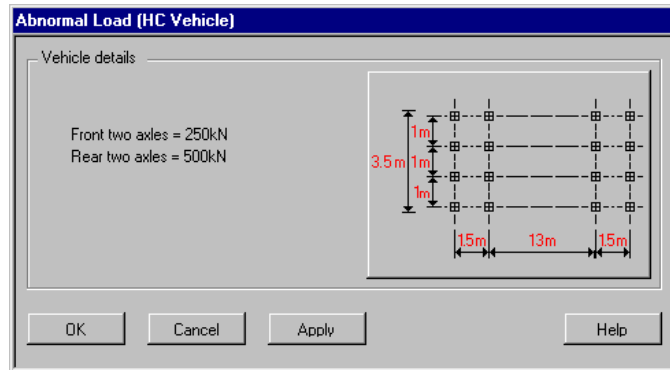

Korea Vehicle Loading

Korean vehicle loads are defined to the Korean loading code.

See [Using static vehicle loadings](#) for general details regarding static vehicle loadings.



Korean DB Vehicle Load

The DB vehicle load generator can produce vehicle loads types DB24, DB18 and DB13.5 including the variable axle spacing which can be set between 4.2m and 9m.

For all the loads types the additional impact factor can be added to the loads based on loaded length.

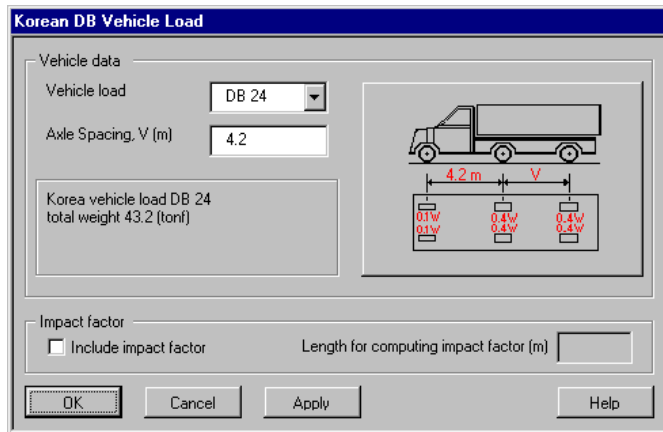

To use this loading type:

- Choose which vehicle you require to generate as a vehicle load.
- Specify the variable axle spacing that you require for the vehicle.
- Choose whether you want to generate a vehicle to represent a forward movement, reverse movement or both directions (Forward is in the negative X direction with the cab at the front).
- If an impact factor is to be considered, select the check box and enter a length for computing the impact factor in the current length units. The impact allowance is a maximum of 30 % making the impact factor a maximum of 1.3. Assuming the model length units to be metres the impact factor is calculated from the equation below.

$$I=15/(40+L)$$

where L=length for computing the impact factor in metres

This equation will automatically be adjusted to take in to account other model units if used. For example if the model length units are feet the impact factor is calculated from the equation below.

$$I=(15*3.28)/((40*3.28)+L)$$

where L=length for computing the impact factor in feet

Korea Lane Load (DL W)

The lane load generator can produce a uniform patch load based on load types DB24, DB18 and DB13.5 and loaded length. For all the loads types the additional impact factor can be added to the loads based on loaded length.

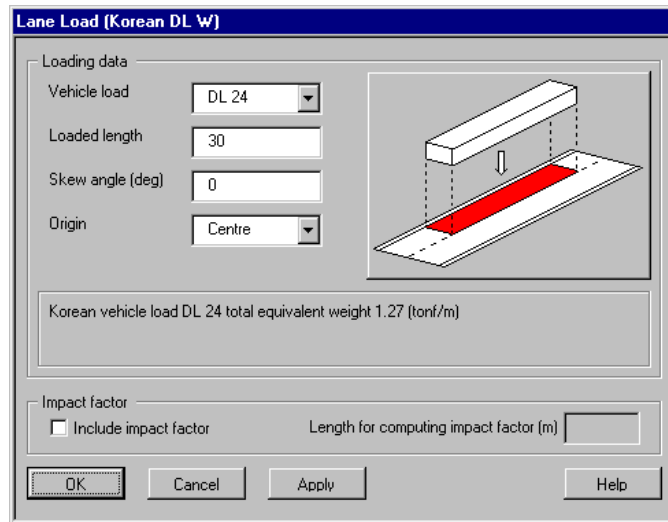

To use this loading type:

- Choose which vehicle you require to generate as a vehicle load.
- Specify the length of lane load that you require to generate.
- Specify the skew angle to apply to the lane loading. (clockwise positive)
- Choose the origin for which the load is to be generated about.
- If an impact factor is to be considered, select the check box and enter a length for computing the impact factor in the current length units. The impact allowance is a maximum of 30 % making the impact factor a maximum of 1.3. Assuming the model length units to be metres the impact factor is calculated from the equation below.

$$I=15/(40+L)$$

where L=length for computing the impact factor in metres

This equation will automatically be adjusted to take in to account other model units if used. For example if the model length units are feet the impact factor is calculated from the equation below.

$$I=(15*3.28)/((40*3.28)+L)$$

where L=length for computing the impact factor in feet

Korea Knife Edge Load (DL Pm)

The knife edge load (Korean DL Pm) generator can produce a line load based on the following load types DB24, DB18 and DB13.5. For all the loads types the additional impact factor can be added to the loads based on loaded length.

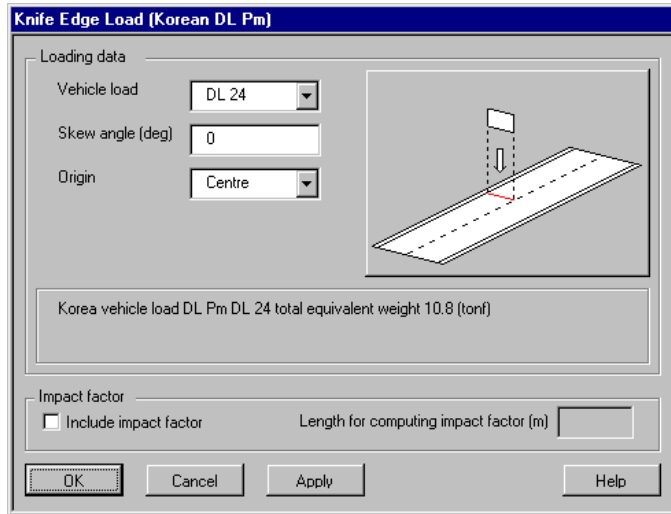

To use this loading type:

- Choose which vehicle you require to generate as a vehicle load.
- Specify the skew angle to applied to the lane loading (clockwise positive).
- Choose the origin for which the load is to be generated about.
- If an impact factor is to be considered, select the check box and enter a length for computing the impact factor in the current length units. The impact allowance is a maximum of 30 % making the impact factor a maximum of 1.3. Assuming the model length units to be metres the impact factor is calculated from the equation below.

$$I=15/(40+L)$$

where L=length for computing the impact factor in metres

This equation will automatically be adjusted to take in to account other model units if used. For example if the model length units are feet the impact factor is calculated from the equation below.

$$I=(15*3.28)/((40*3.28)+L)$$

where L=length for computing the impact factor in feet

Korea Knife Edge Load (DL Ps)

The knife edge load (Korean DL Ps) generator can produce a line load based on the following load types DB24, DB18 and DB13.5. For all the loads types the additional impact factor can be added to the loads based on loaded length.

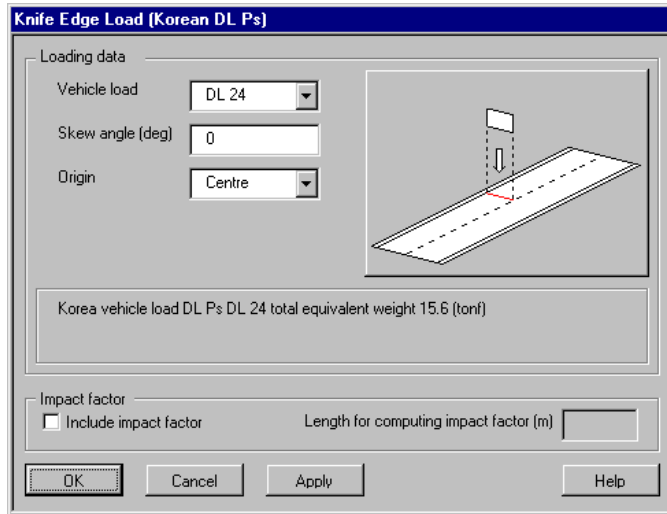

To use this loading type:

- Choose which vehicle you require to generate as a vehicle load.
- Specify the skew angle to applied to the lane loading (clockwise positive).
- Choose the origin for which the load is to be generated about.
- If an impact factor is to be considered select the check box and enter a length for computing the impact factor in the current length units. The impact allowance is a maximum of 30 % making the impact factor a maximum of 1.3. Assuming the model length units to be metres the impact factor is calculated from the equation below.

$$I=15/(40+L)$$

where L=length for computing the impact factor in metres

This equation will automatically be adjusted to take in to account other model units if used. For example if the model length units are feet the impact factor is calculated from the equation below.

$$I=(15*3.28)/((40*3.28)+L)$$

where L=length for computing the impact factor in feet

NATO Vehicle Loading

This comprises NATO vehicle loads as defined in annex A of STANAG 2021. Sixteen Military Load Classification (MLC) vehicle classes, each comprising a “Tracked” and corresponding “Wheeled” vehicle are listed, making thirty-two vehicles in total.

See [Using static vehicle loadings](#) for general details regarding static vehicle loadings.



NATO MLC Wheeled Vehicles

A range of wheeled vehicles for classes MLC-4 to MLC-150 are supplied.

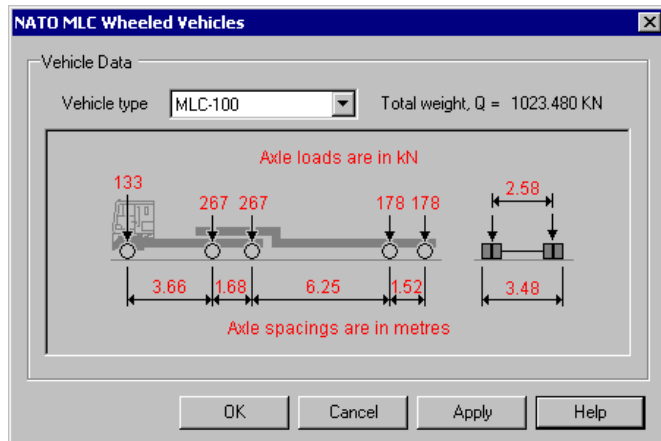

To use this loading type:



- Choose the vehicle type from the drop down list.
- A discrete point load attribute is generated in the Attributes  Treeview with a point load at each wheel position. This discrete load should be assigned to a point on a model.

NATO MLC Tracked Vehicles

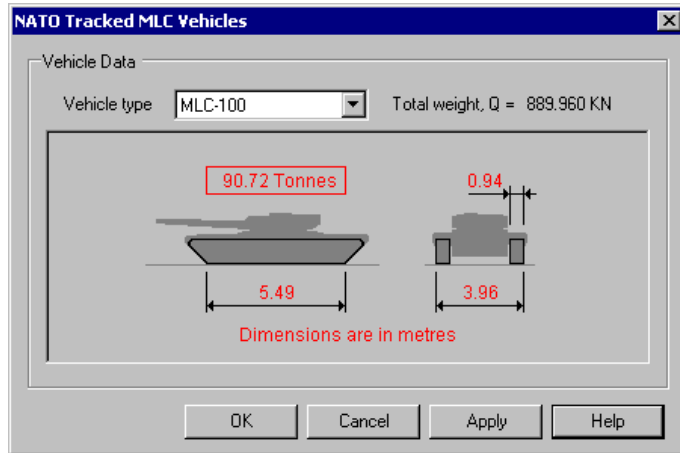
A range of tracked vehicles for classes MLC-4 to MLC-150 are supplied.



To use this loading type:

- Choose the vehicle type from the drop down list.
- A compound discrete load attribute is generated in the Attributes  Treeview. The compound attribute combines two patch loads and should be assigned to a point on the model.
- A discrete patch load attribute is generated in the Attributes  Treeview for each track, with each load being used in a Compound discrete load attribute that should be assigned to a point on a model.

Note that military vehicles defined in Swedish code VVPubl. 2009:61 are identical to the vehicles defined here.

New Zealand Vehicle Loading

New Zealand vehicle loads are defined to the New Zealand loading code.

See [Using static vehicle loadings](#) for general details regarding static vehicle loadings.



New Zealand Lane Loads

The lane load generator produces a uniform patch load based on notional lane width, loaded length and intensity. The intensity of the lane load has a default value set but can be modified to any value required.

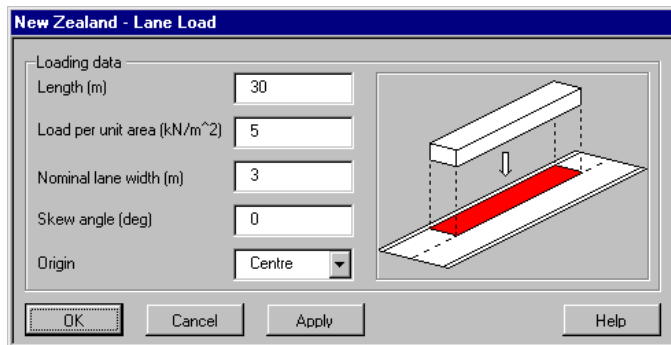

To use this loading type:

- Specify the loaded length.
- Specify the load per unit area.
- Specify the notional lane width.
- Specify the skew angle to apply to the lane loading (clockwise positive).
- Choose the origin about which the load is to be generated.

New Zealand Knife Edge Loads (KEL) Loads

The KEL load generator produces a knife-edge load based on notional lane width and intensity. The intensity of the knife-edge load has a default value set but can be modified to any value required.

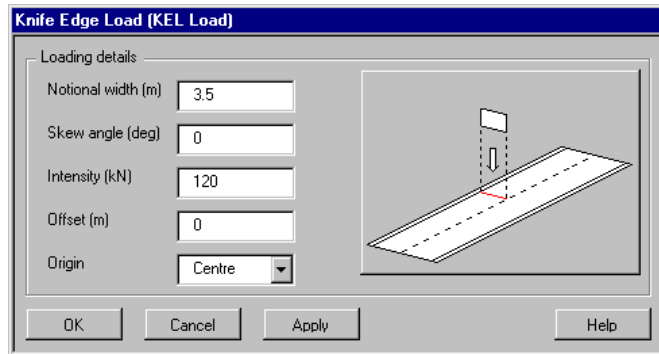

To use this loading type:

- Specify the notional width.
- Specify the skew angle to apply to the lane loading (clockwise positive).
- Specify the intensity.
- Specify the offset.
- Choose the origin about which the load is to be generated.

New Zealand Vehicle Load

The following truck types can be created: HN (normal) and HO (overload).

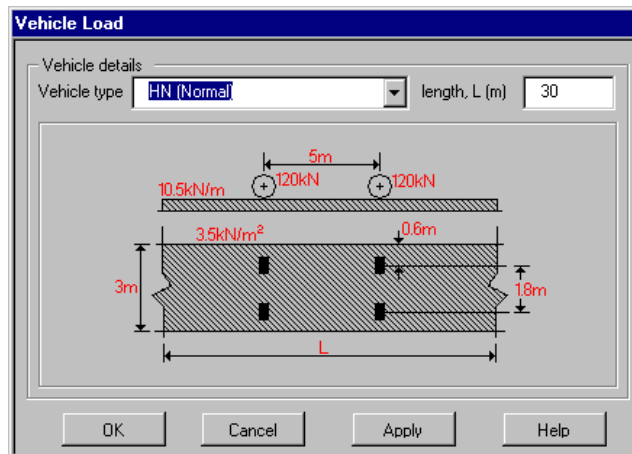

To use this loading type:

- Choose the vehicle type required, and specify the length if applicable.

Norway Vehicle Loading

Norway vehicle loads are defined to the Norwegian loading design code.

See [Using static vehicle loadings](#) for general details regarding static vehicle loadings.

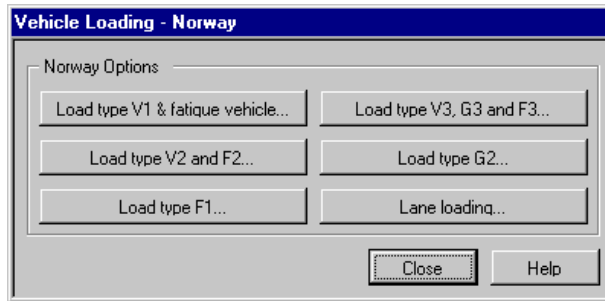

Norway Load Type V1 & Fatigue Vehicle

The load type V1 & Fatigue Vehicle generator produces vehicle loads based on the selection of type V1 & Fatigue Vehicle. The variable axle spacings can be set to the required distance.

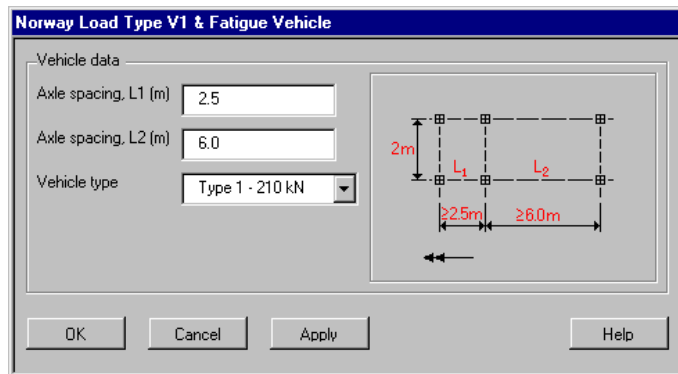

To use this loading type:

- Choose the axle spacings for L1 and L2 that you require for the vehicle. Note that L1 has to be greater than 2.5m and L2 greater than 6m. The vehicle will be generated about the second axle's centre point.
- Choose the vehicle type from the drop down list.

Norway Load Types V2 and F2

The load types V2 and F2 generator produce vehicle loads based on the selection of type V2 or F2.

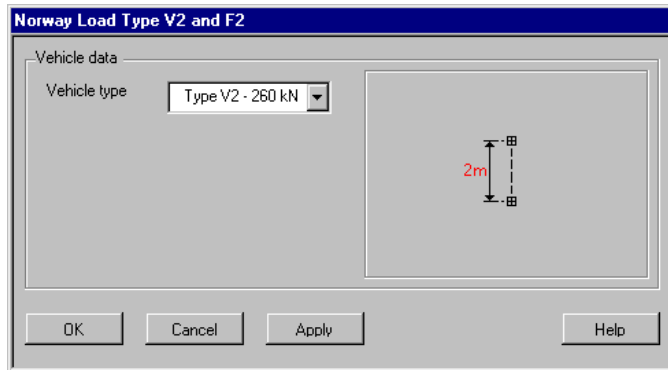

To use this loading type:

- Choose the vehicle type from the drop down list. The vehicle will be generated about the axle's centre point.

Norway Load Types F1

The load type F1 generator produces a vehicle load based on the selection of type F1.

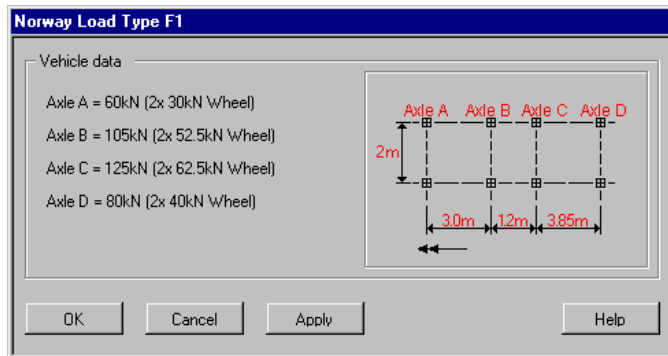

Norway Load Types V3, G3 and F3

The load types V3, G3 and F3 generator produces vehicle loads based on the selection of type V3, G3 and F3 .

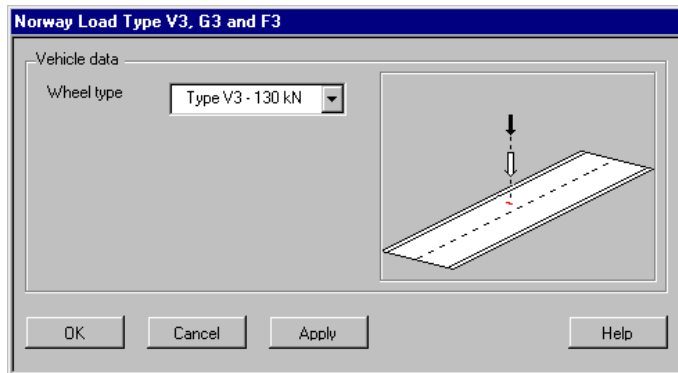

To use this loading type:

- Choose the vehicle type from the drop down list.

Norway Load Types G2

The load type G2 generator produces a vehicle load based on the selection of type G2.

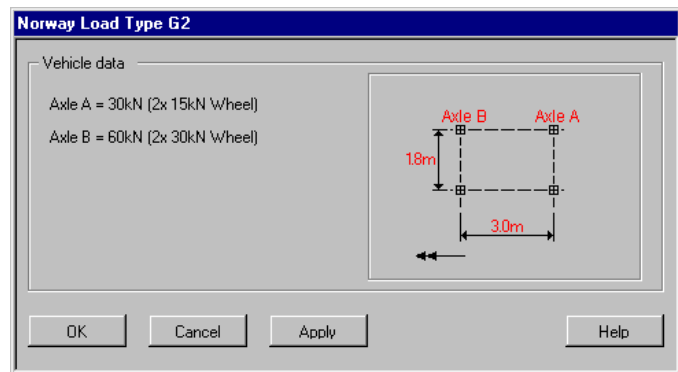

Norway Lane Load

The lane load generator produces a uniform patch load based on loaded length and intensity. The intensity of the lane load has a default value set but can be modified to any value required.

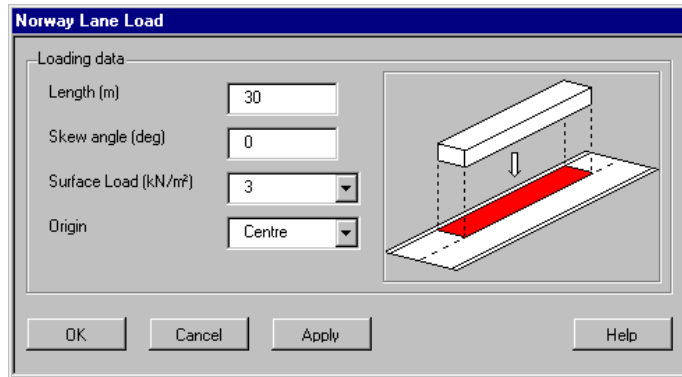

To use this loading type:

- Specify the length of lane load that you require to generate about the centre line of patch.
- Specify the skew angle to applied to the lane loading (clockwise positive).
- Specify the Surface load intensity from the drop down list.
- Choose the origin that the load will be generated about.

Poland Vehicle Loading

Poland vehicle loads are defined to the Polish loading code.

See [Using static vehicle loadings](#) for general details regarding static vehicle loadings.

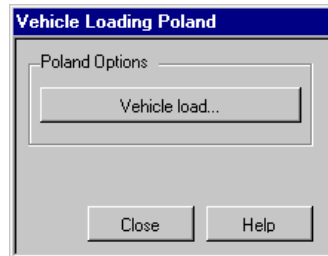

Poland Vehicle Loads

The Poland vehicle load generator produces the following grades of automobile loads:

- K-Class types A to E
- S-Class 123, 4 and 5

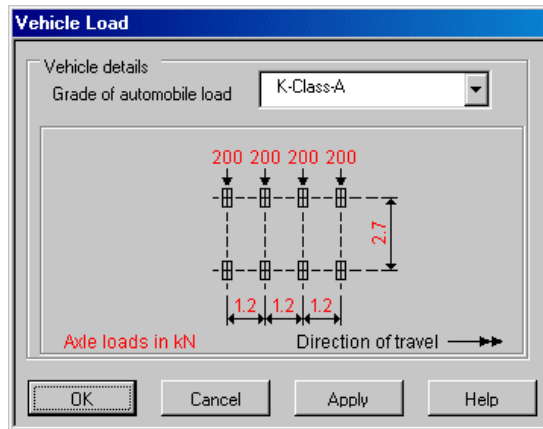

To use this loading type:

- Select a vehicle load type and press the OK or Apply button to add that loading to the Attributes  Treeview.

Poland Military Vehicles

Military vehicles for Poland are not currently supplied but note that NATO military vehicles (which differ slightly from the Poland vehicles) are supplied. See [NATO Vehicle Loading](#) for details.

South Africa Vehicle Loading

South Africa vehicle loads are defined to the TMH7 Code of Practice for the Design of Bridges and Culverts in South Africa 1981 with 1988 revisions.

Vehicle loads can be created for normal vehicle loading (NA), single abnormal vehicle loading (NB) and multi-wheeled trailer combination or multi-wheeled self-propelled vehicle loading (NC) loads with reference to TMH7 parts 1 and 2.

See [Using static vehicle loadings](#) for general details regarding static vehicle loadings.



South Africa Lane Loads (NA Load)

For normal vehicle loading the lane load generator produces a uniform patch load based on a nominal lane width and loaded length. A skew angle can be defined and if done, should be defined clockwise positive. The intensity of loading is in accordance with the loading curve for NA loading as defined in the code.

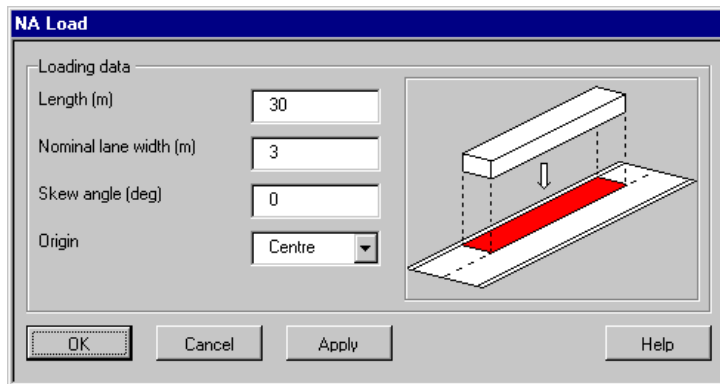

To use this loading type:

- Specify the loaded length.
- Specify the nominal lane width.
- Specify the skew angle to apply to the lane loading (clockwise positive).
- Choose the origin about which the load is to be generated.

South Africa Vehicle Load (NA Axle)

For NA axle loads a nominal axle load at a specified width can be defined. Two point loads are generated of an intensity computed in Kn from the formula $(\text{Axle load})/\sqrt{n}$ kN where n is the loading sequence number. For multiple applications of an axle load

across more than one lane the loading sequence identifier should be incremented each time in accordance with the code. Setting an offset will position the loading away from an origin point that itself can be defined in one of three positions.

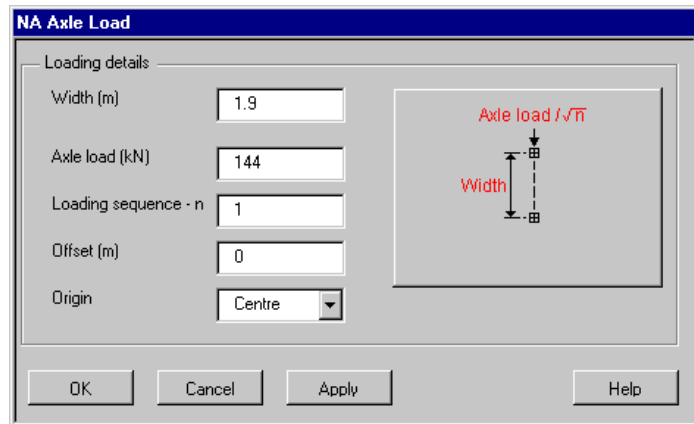

To use this loading type:

- Specify the width between wheels.
- Specify the axle load.
- Increment the loading sequence if loading is to be added to a different lane to any previously defined loading.
- Enter an offset (if any) and choose the origin about which the load is to be generated.

South Africa Vehicle Load (NB load)

NB loading is a notional load representing a single abnormal vehicle. For this loading pre-defined axle spacings and a choice of units of HB are available. The dialog allows selection of axle widths of 6, 11, 16, 21 or 26m and generates 24 or 36 units of NB loading where 1 unit is equal to 2.5kN per wheel.

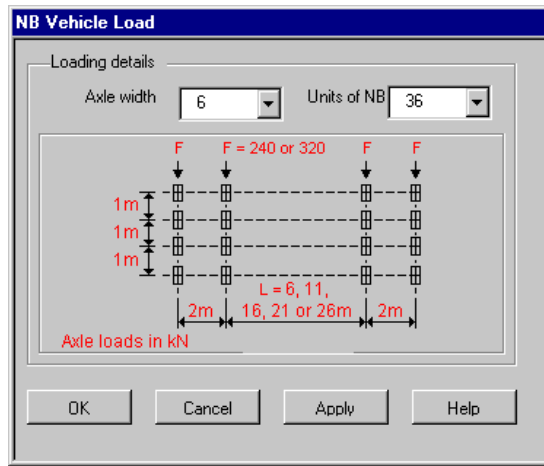

To use this loading type:

- Choose a longitudinal length between internal axles
- Choose the appropriate units of HB

South Africa Vehicle Load (NC load)

NC loading represents a multi-wheeled trailer combination (or self-propelled multi-wheeled vehicles) with controlled hydraulic suspension and steering intended to transport very heavy indivisible payloads. These loads are represented by a grid of point loads with a load intensity of 30kN/m^2 . The dimensions a, b and c should be selected between the limits shown to have the most severe effect.

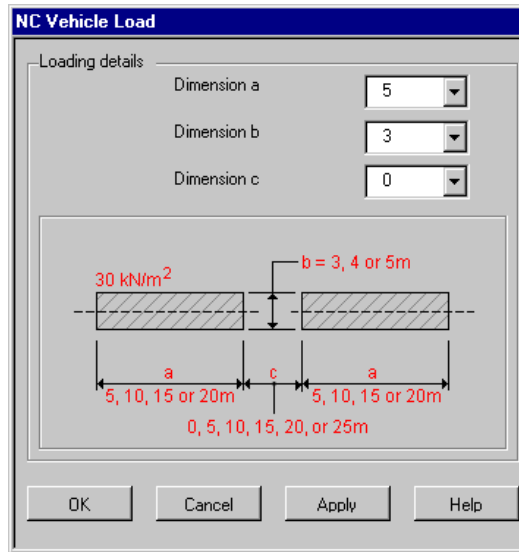

To create this loading type:

- Specify the extent of the loading by defining dimensions a, b and c.

For this loading a number of discrete load attributes will be created that are used to define a compound load. It is the compound load that should be assigned to the model.

Sweden Vehicle Loading

Swedish vehicle loads are defined to Swedish bridge BRO Classification loads.

See [Using static vehicle loadings](#) for general details regarding static vehicle loadings.

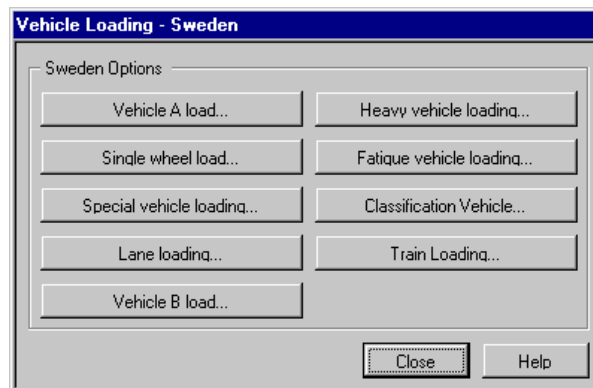

Sweden BRO Vehicle Load A

The load type A generator produces a vehicle load based on axle weight (250kN or 170kN). The variable axle spacings can be set to the required distance.

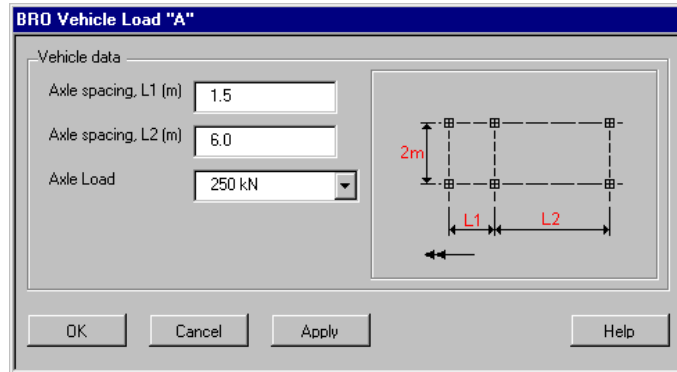

To use this loading type:

- Specify the front axle spacing that you require for the vehicle.
- Specify the back axle spacing that you require for the vehicle.
- Choose which intensity of axle load you wish to generate.

Sweden BRO Single Wheel Load

The load single wheel generator produces a point load of 155kN.

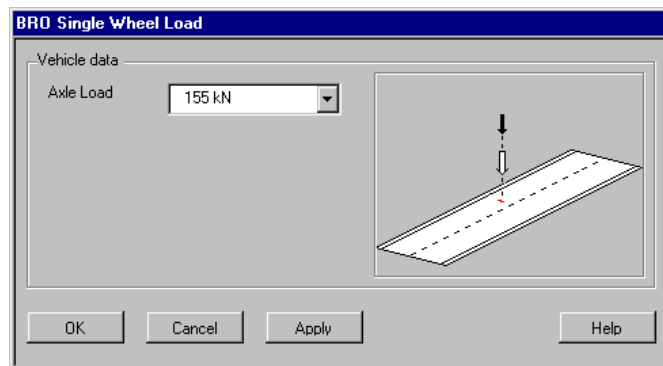

Sweden BRO Special Vehicle Loading

The special vehicle load generator produces a vehicle load based on axle weight (250kN or 170kN). The load represents two vehicles each with three axles, separated by a distance L3.

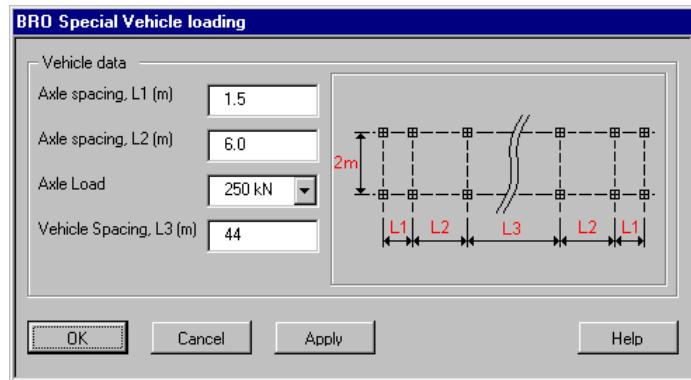

To use this loading type:

- Specify the front axle spacing that you require for the vehicle.
- Specify the back axle spacing that you require for the vehicle.
- Choose which intensity of axle load you wish to generate.
- Specify the distance between the vehicles.

Sweden BRO Lane Load

The lane load generator produces a uniform patch load based on loaded length and intensity.

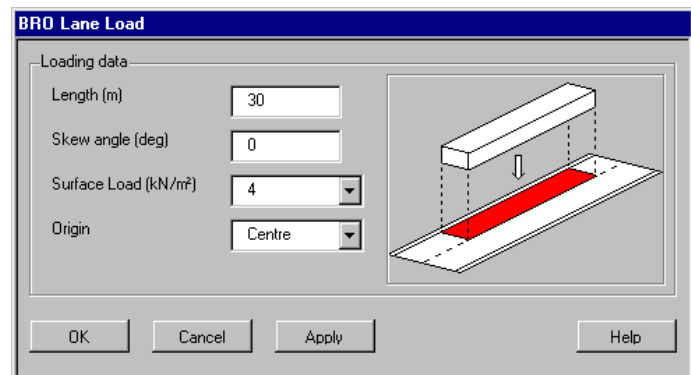

To use this loading type:

- Specify the length of lane load.
- Specify the skew angle to apply to the lane loading. (clockwise positive)
- Choose which intensity of load you wish to generate.

- Choose the origin for the about which the load is to be positioned.

Sweden BRO Vehicle Load B

The load type B generator produces a single axle load of weight 310kN or 210kN.

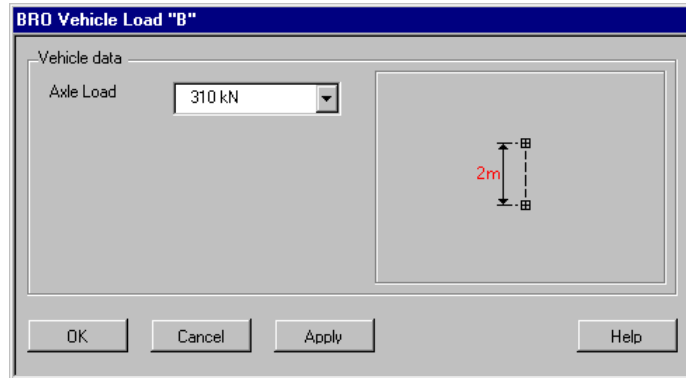

To use this loading type:

- Choose which intensity of load you wish to generate.

Sweden BRO Heavy Vehicle Load

The heavy vehicle load produces a three axle vehicle with an axle weight of 325kN.

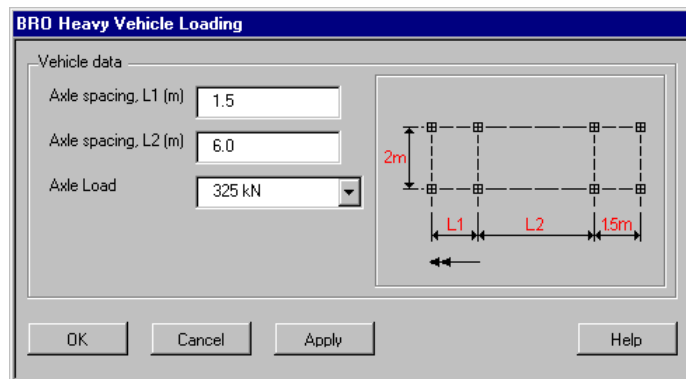

To use this loading type:

- Specify the front axle spacing that you require for the vehicle.
- Specify the back axle spacing that you require for the vehicle.
- Choose which intensity of load you wish to generate.

Sweden BRO Fatigue Vehicle Load

The fatigue load generator produces a vehicle load with four axles. The front two are 150kN, the rear two are 180kN each. The variable axle spacings can be set to the required distance.

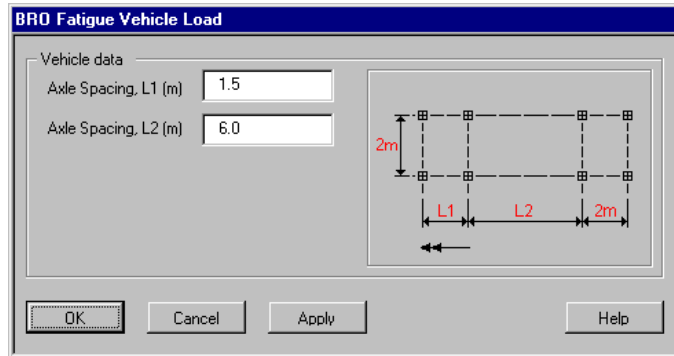

To use this loading type:

- Specify the axle spacing that you require for the vehicle.

Sweden BRO Classification Vehicles

The classification vehicle generator produces the following vehicle loads: Type a, b, c, d, e, f, g, h, i, j, k, l, m, n, military vehicle 45 ton and military vehicle 60 ton. Each of these vehicles can have many different configurations by setting the number of axle weights and spacings.

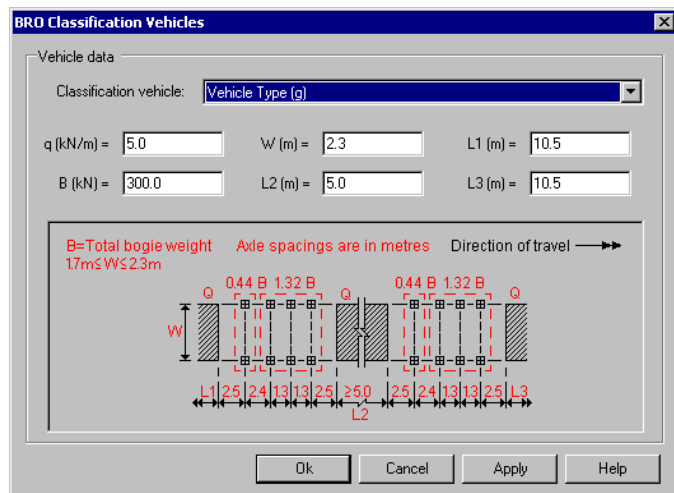

To use this loading type:

- Choose the classification vehicle required from the list.
- Specify the patch load intensity, Q , in kN/m^2
- Specify the bogey weight, B , in kN
- Specify the width of vehicle, W , in metres
- Specify the axle spacings; $L1$, $L2$ and $L3$, in metres

Notes

- Classification vehicles (g) to (l) and Military Vehicle 45 ton and Military Vehicle 60 ton will consist of several discrete load parts combined into a compound loading attribute.

Sweden BRO Train Loading

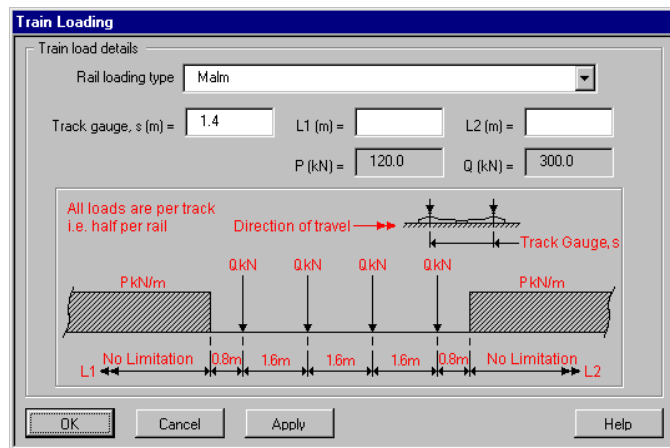

To use this loading type:

- Select the standard rail loading type from the drop down list.
- Enter the track gauge in metres. This has to be 1.4m or greater.
- Enter the dimension data required as appropriate for the chosen load to be generated. All dimensions are in metres and kN .

Notes

- The trainload will be generated about the loaded area's centre point.

- Load Model HSLM (High Speed Load Model) is only used in dynamic analysis and comprises of two separate Universal Trains with variable coach lengths, HSLM-A and HSLM-B.
- Limits of validity of Load Model HSLM are given in EN 1991-2 Annex E.
- Load Model HSLM is generally used to represent the loading from passenger trains at speed exceeding 200 km/h (dynamic analysis).
- The load HSLM-B should only be applied to simply supported plate bridges and simply supported beam bridges, or similar, with span lengths below 7m.
- Continuous bridges are not applicable for HSLM B.
- The definition of L is the span length.
- All other dynamic analyses on railway bridges should use the load HSLM-A.

Rail Loading Type Malm, Malm 2000 and BV 2000

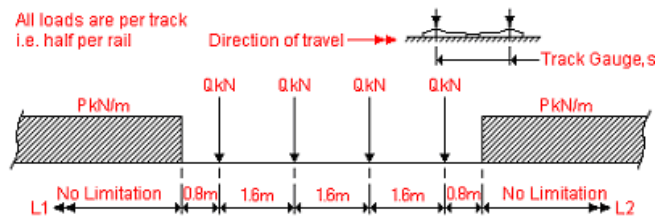

Malm, Malm 2000 and BV 2000

Train Load	P (kN)	Q (kN/m)
Malm	300	110
Malm 2000	350	120
BV 2000	330	120

Rail Loading Type RV-25 / RV-30

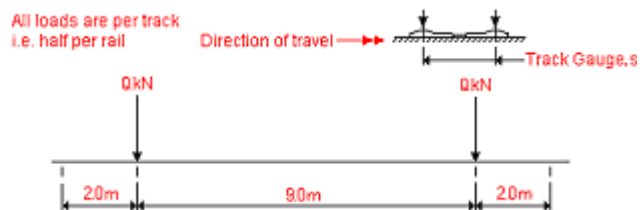

RV-25 / RV-30 Point load arrangement

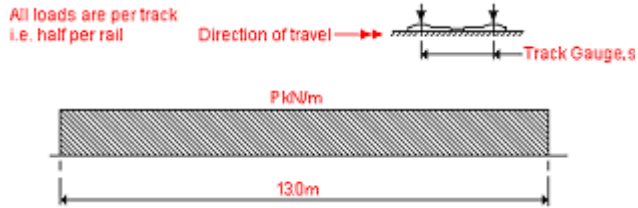

RV-25 / RV-30 UDL arrangement

Train Load		Load
RV25	Point, Q (kN)	250
	UDL, P (kN/m)	39
RV-30	Point, Q (kN)	300
	UDL, P (kN/m)	46

Rail Loading Type A to BV-4

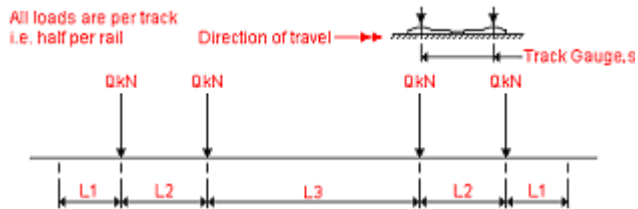

Train loads A to BV-4 Point load arrangement

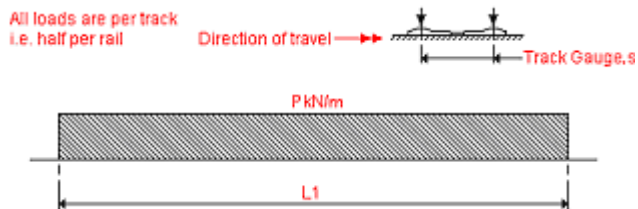

Train loads A to BV-4 arrangement UDL

Train Load		Load	L1 (m)	L2 (m)	L3 (m)
A	Point, Q (kN)	160	1.50	1.80	5.20
	UDL, P (kN/m)	50	12.80		
B1	Point, Q (kN)	180	1.50	1.80	7.80
	UDL, P (kN/m)	50	14.40		
B2	Point, Q (kN)	180	1.50	1.80	4.65
	UDL, P (kN/m)	64	11.25		
C2	Point, Q (kN)	200	1.50	1.80	5.90
	UDL, P (kN/m)	64	12.50		
C3	Point, Q (kN)	200	1.50	1.80	4.50
	UDL, P (kN/m)	72	11.10		
C4	Point, Q (kN)	200	1.50	1.80	3.40
	UDL, P (kN/m)	80	10.0		
D2	Point, Q (kN)	225	1.50	1.80	7.45
	UDL, P (kN/m)	64	14.05		
D3	Point, Q (kN)	225	1.50	1.80	5.90
	UDL, P (kN/m)	72	12.50		
D4	Point, Q (kN)	225	1.50	1.80	4.65
	UDL, P (kN/m)	80	11.25		
BV-2	Point, Q (kN)	250	1.50	1.80	7.30
	UDL, P (kN/m)	72	13.90		
BV-3	Point, Q (kN)	250	1.50	1.80	5.90
	UDL, P (kN/m)	80	12.50		
BV-4	Point, Q (kN)	300	1.50	1.80	5.40
	UDL, P (kN/m)	100	12.0		

Rail Loading Type HSLM-A (A1 to A10)

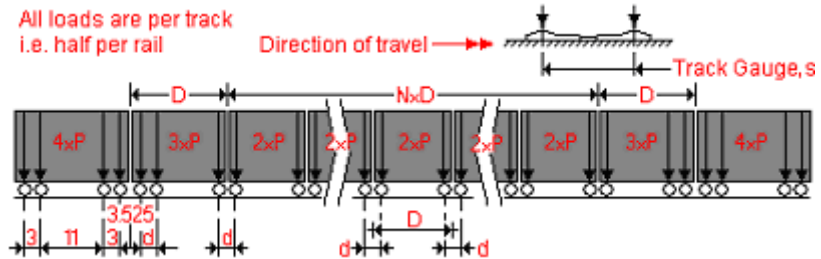

Train loads HSLM-A (A1 to A10)

Universal Train	Number of intermediate coaches (N)	Coach length D (m)	Bogie axle spacing d (m)	Point force P (kN)
A1	18	18	2.0	170
A2	17	19	3.5	200
A3	16	20	2.0	18
A4	15	21	3.0	190
A5	14	22	2.0	170
A6	13	23	2.0	180
A7	13	24	2.0	190
A8	12	25	2.5	190
A9	11	26	2.0	210
A10	11	27	2.0	210

Rail Loading Type HSLM-B

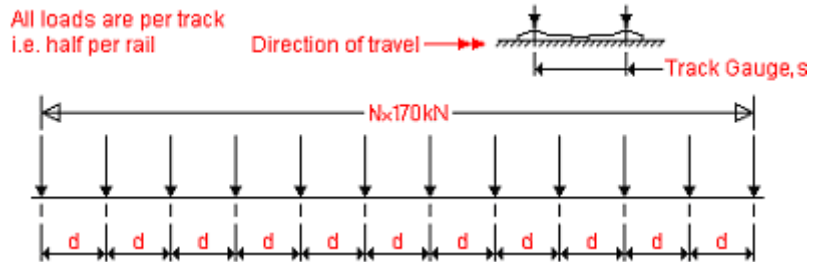

Train load HSLM-B

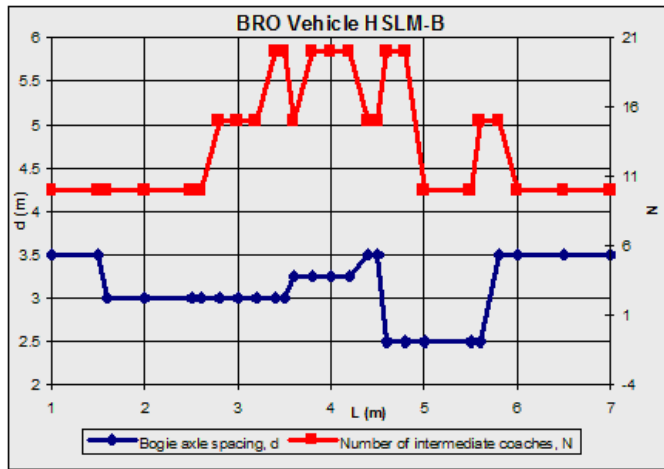

Sweden Military Vehicles

Vehicles defined in VV 2009-61 MB802 Barighetsutredning Av Byggnadsver (Swedish design code) are seen to be identical to the vehicles defined in STANAG 2012 Annex A. See [NATO Vehicle Loading](#) for details.

United Kingdom Vehicle Loading

The United Kingdom vehicle loads are defined to the UK bridge codes BS5400, BD37/88, BD37/01, BD21/97, BD21/01 and EN1991-2 National Annex 2.16

See [Using static vehicle loadings](#) for general details regarding static vehicle loadings.

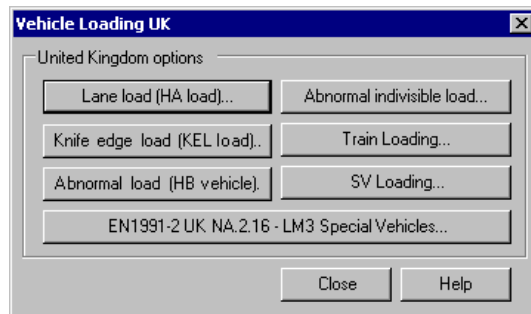

United Kingdom HA Loads

The HA load generator produces a uniform patch load based on notional lane width and loaded length. The intensity of the patch is calculated based on the loaded length

entered with shorter loaded lengths having higher intensity. The exact intensity will depend on the code being used.

For the assessment codes BD21/97 and BD21/01 an additional reduction factor can be included. This is based on the assessment live load being used and the road category type.

The screenshot shows the 'Lane Load (HA Load)' dialog box. It is divided into several sections. The top section, 'Loading details', contains five input fields: 'Loading code' (a dropdown menu showing 'BD21/97'), 'Loaded length (m)' (a text box with '30.0'), 'Notional width (m)' (a text box with '2.5'), 'Skew angle (deg)' (a text box with '0.0'), and 'Origin' (a dropdown menu showing 'Centre'). To the right of these fields is a 3D perspective diagram of a rectangular load on a road surface, with a downward arrow indicating the load direction. Below the 'Loading details' section is a section for 'Assessment reduction factor' which includes a checked checkbox, 'Assessment live load' (a dropdown menu showing '40 Tonnes'), 'Include adjustment factor, AF = 1.23' (a checked checkbox), 'Road category type' (a dropdown menu showing 'Heavy Traffic Poor Surface (Hp)'), and 'Reduction factor, K = 0.91'. At the bottom of the dialog are four buttons: 'Ok', 'Cancel', 'Apply', and 'Help'.

To use this loading type:

- Choose the loading code to be used
- Specify the loaded length..
- Specify the notional width of lane load..
- Specify the skew angle to apply to the lane loading (clockwise positive).
- Choose the origin about which the load is to be generated.

Notes

- If an assessment code (BD21/97 or BD21/01) has been selected from the design code list the option to apply an assessment reduction factor will be given. Switching this option off will generate a nominal unfactored assessment load.
 - Select the assessment live load vehicle type from the list
 - Select the road category type from the list
 - Choose whether to include the adjustment factor, AF, in the calculation.

- The calculate reduction factor will be displayed. Clicking the Apply button to generate the loading will also apply the calculated factor. For assessment loading the loaded length must be between 2m and 50m. For loaded lengths outside of this range the user should seek advice from the appropriate design code.

United Kingdom KEL Loads

The KEL load generator produces a knife-edge load based on notional lane width and intensity. The intensity of the knife-edge load has a default value set but can be modified to any value required.

For the assessment codes BD21/97 and BD21/01 an additional reduction factor can be included. This is based on the assessment live load being used and the road category type.

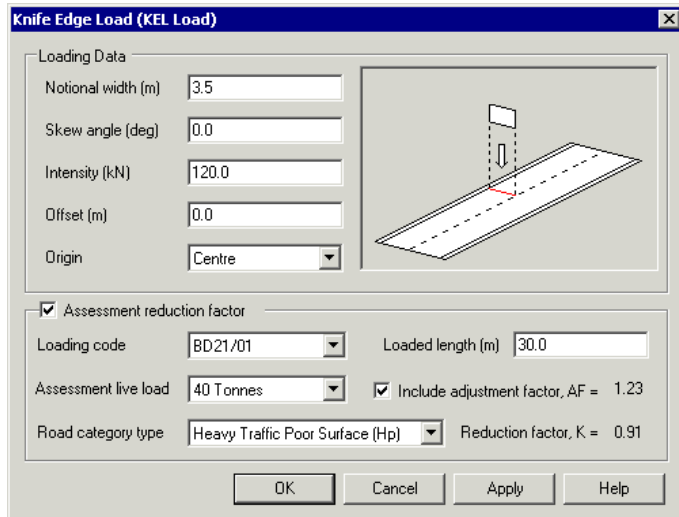

To use this loading type:

- Specify the width of lane load.
- Specify the skew angle to apply to the lane loading (clockwise positive).
- Specify the intensity of load.
- Specify the offset for the load.
- Choose the origin for the about which the load is to be generated.

Assessment reduction factor:

- The option to apply an assessment reduction factor is given. Switching this option off will generate a nominal unfactored assessment load.
- Select the assessment live load vehicle type from the list
- Select the road category type from the list
- Specify the length of carriageway to allow the assessment reduction factor to be calculated.
- Choose whether to include the adjustment factor, AF, in the calculation.
- The calculate reduction factor will be displayed. Clicking the Apply button to generate the loading will also apply the calculated factor.

United Kingdom Abnormal Load Generator (HB Vehicle)

The HB load generator produces a HB vehicle by setting the inner axle spacing (6m, 11m, 16m, 21m, & 26m) and the number of HB units required (25-45).

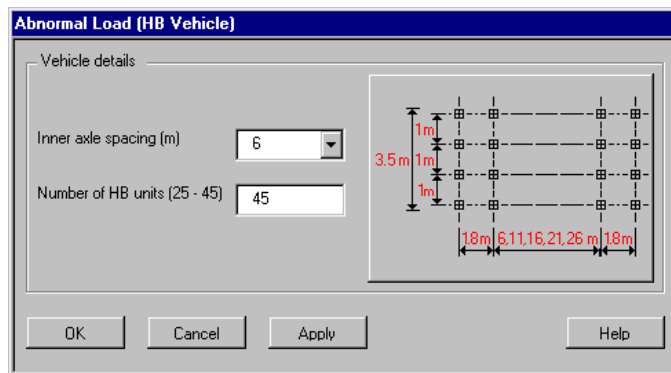

To use this loading type:

- Choose the inner axle spacing.
- Specify the number of HB units to be considered for the vehicle.

United Kingdom Abnormal Indivisible Loads

The abnormal indivisible load generator produces loads that represent heavy haulage vehicles. Many different configurations of trailer and tractor units can be created with user-defined loading intensities.

To use this loading type:

- Choose which trailer you require to generate as a vehicle load. A description is provided in the right hand panel.
- Specify the inner axle spacing for the trailer.
- Specify the approximate tare of the trailer.
- Specify the approximate payload of the trailer.
- Choose the tractor arrangement that is required for the vehicle.
- Choose the trailer type (a description is given in the panel above)
- Choose distance of tow to tractor (one or two)
- If a trailer with ACE has been chosen set up the details of the air skirt.

United Kingdom Special Vehicle Loads

The UK special vehicle loading dialog allows the creation of SV loading as defined in BD 86/11 “The Assessment of Highway Bridge and Structures for the Effects of Special Types General Order (STGO) and Special Order (SO) Vehicles”.

See [Using static vehicle loadings](#) for general details regarding static vehicle loadings.

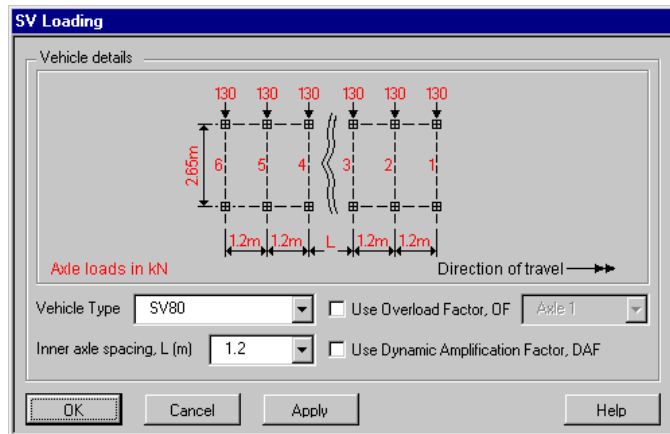

- ❑ **Vehicle Type** SV loading is defined in accordance to BD86/11 “The Assessment of Highway Bridge and Structures for the Effects of Special Types General Order (STGO) and Special Order (SO) Vehicles”. Five load models can be generated that simulate the vertical effects of different types of STGO vehicles with basic axle weights not exceeding 16.5 tonnes and military tank transporter vehicles with basic axle weights of up to 25 tonnes.

- The SV80 vehicle is intended to model the effects of STGO Category 2 vehicles with a maximum gross vehicle weight of 80 tonnes and a maximum basic axle load of 12.5 tonnes.
- The SV100 vehicle is intended to model the effects of STGO Category 3 vehicles with a maximum gross vehicle weight of 100 tonnes and a maximum basic axle load of 16.5 tonnes.
- The SV150 vehicle is intended to model the effects of STGO Category 3 vehicles with a maximum gross vehicle weight of 150 tonnes and a maximum basic axle load of 16.5 tonnes.
- The SV-Train is intended to model the effects of a single locomotive pulling a Category 3 trailer.
- The SV-TT is intended to model the effects of a military tank transporter vehicles with a maximum basic axle load of 25 tonnes.

- ❑ Choose the **Overload Factor**, OF, to model SV vehicles in excess of the gross weight and axle weights notified by the hauliers to highway authorities. The Overload Factor shall be taken as 1.2 for the worst critical axle, chosen from the drop-down list, and 1.1 for all other axles.

- ❑ The **Dynamic Amplification Factor**, DAF, will factor each axle using the following equation:

$$DAF = [1.7 \times (\text{basic axle load} / 10)^{-0.15}] \geq 1.05$$

United Kingdom EN 1991-2 UK National Annex 2.16 LM3 Special Vehicle Loads

Special vehicle types SV and SOV as defined as Load Model 3 in the UK National Annex to EN 1991-2:2003.

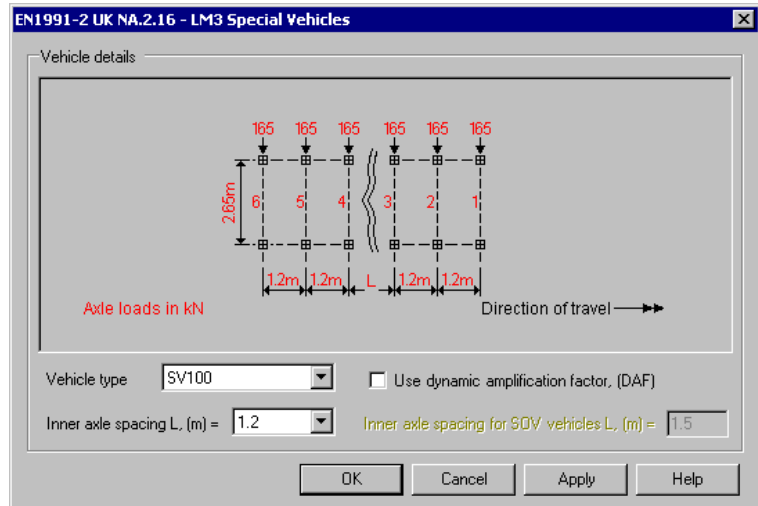

SV Vehicles

- Vehicle Type** Three load models can be generated that simulate the vertical effects of different types of STGO vehicles with basic axle weights not exceeding 16.5 tonnes:
 - The SV80 vehicle is intended to model the effects of STGO Category 2 vehicles with a maximum gross vehicle weight of 80 tonnes and a maximum basic axle load of 12.5 tonnes.
 - The SV100 vehicle is intended to model the effects of STGO Category 3 vehicles with a maximum gross vehicle weight of 100 tonnes and a maximum basic axle load of 16.5 tonnes.
 - The SV196 vehicle is intended to model the effects of a single locomotive pulling a STGO Category 3 load with a maximum gross vehicle weight of 150 tonnes and a maximum basic axle load of 16.5 tonnes with the gross weight of the vehicle load train not exceeding 196 tonnes.

- The Dynamic Amplification Factor, DAF**, will factor each axle according to values set out in Table NA 2 of the UK National Annex to EN 1991-2:2003, namely:

Basic axle load Dynamic amplification factor

100kN	1.20
130kN	1.16
165kN	1.12
180kN	1.10
225kN	1.07

- ❑ Inner axle spacing can be set to 1.2, 5.0, or 9.0m

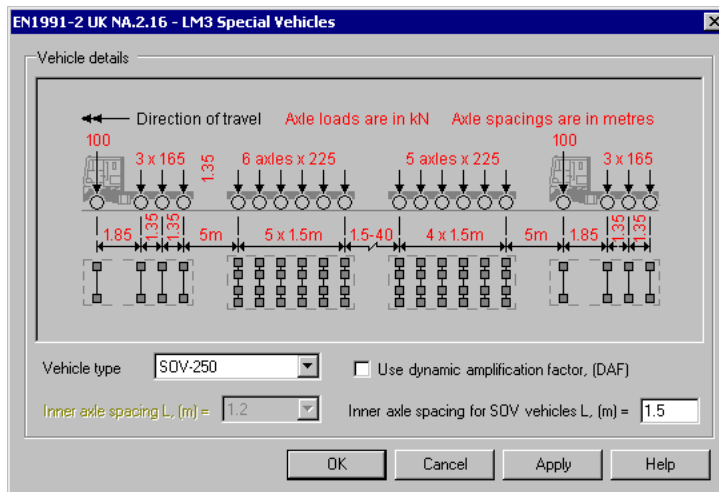

SOV Vehicles

- ❑ **Vehicle Type** Four load models can be generated to simulate vertical effects of Special Order Vehicles (SOV) with trailer weights limited to four different tonnages:
 - The SOV-250 vehicle models a maximum total weight of SO trailer units up to 250 tonnes.
 - The SOV-350 vehicle models a maximum total weight of SO trailer units up to 350 tonnes
 - The SOV-450 vehicle models a maximum total weight of SO trailer units up to 450 tonnes
 - The SOV-600 vehicle models a maximum total weight of SO trailer units up to 600 tonnes
- ❑ The **Dynamic Amplification Factor**, DAF, will factor each axle according to values set out in Table NA 2 of the UK National Annex to EN 1991-2:2003, as tabulated in the SV vehicles section of this topic.

- ❑ Inner axle spacing for SOV vehicles must be set between 1.5 and 40m..

United Kingdom Train Loading

The train load generator can produce loading types RU, SW/0, SW/2, RL, RA1, RT, Class 67 and Class 91.

See [Using static vehicle loadings](#) for general details regarding static vehicle loadings.

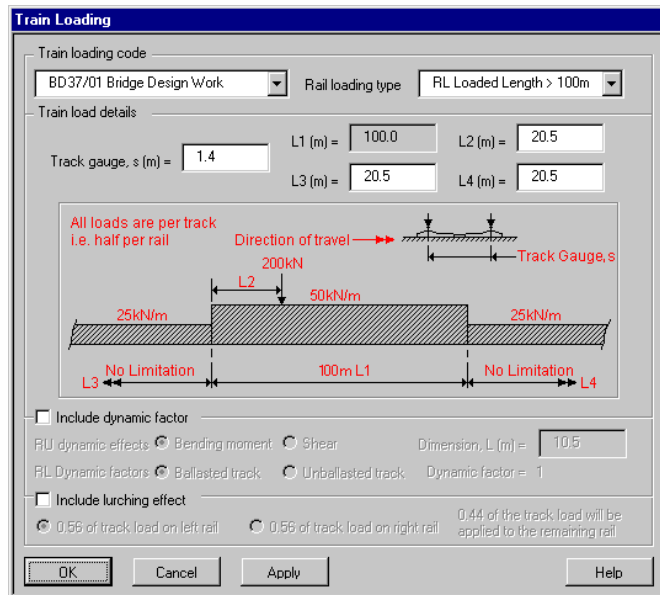

- ❑ **Train loading code** Defines the design code to be used
- ❑ **Rail loading type** Standard railway loading consists at two types, RU and RL. RU loading allows for all combinations of vehicles currently running or projected to run on railways in the Continent of Europe, including the United Kingdom, and is to be adopted for the design of bridges carrying main line railways of 1.4m gauge and above.
 - RL loading is a reduced loading for use only on passenger rapid transit railway systems on lines where main line locomotives and rolling stock do not operate. The derivation of standard railway loadings is given in appendix D of BD37.
 - Nominal type RU loading consists of four 250kN concentrated loads preceded, and followed, by a uniformly distributed load of 80kN/m.
 - Nominal type SW/0 loading consists of a two uniformly distributed loads of 133kN/m, each 15m long and separated by a distance of 5.3m.

- Nominal type RL loading consists of a single 200kN concentrated load coupled with a uniformly distributed load of 50kN/m for loaded lengths up to 100m. For loaded lengths in excess of 100m the distributed nominal load shall be 50kN/m for the first 100m and shall be reduced to 25kN/m for lengths in excess of 100m. Alternatively, two concentrated nominal loads, one of 300kN and the other of 150kN, spaced at 2.4m intervals along the track, shall be used on deck elements where this gives a more severe condition. These two concentrated loads shall be deemed to include dynamic effects.
- The standard railway loadings RU and RL as specified in BD37 clause 8.2.1 and 8.2.2 (except the 300kN and 150kN concentrated alternative RL loading) are equivalent static loadings and shall be multiplied by appropriate dynamic factors to allow for impact, oscillation and other dynamic effects including those caused by track and wheel irregularities.

□ **Include dynamic factor** In deriving the dynamic factor, L is taken as the length (in m) of the influence line for deflection of the element under consideration. For unsymmetrical influence lines, L is twice the distance between the point at which the greatest ordinate occurs and the nearest end point of the influence line. In the case of floor members, 3m should be added to the length of the influence line as an allowance for load distribution through track. The dynamic factors given below should be adopted, provided that maintenance of track and rolling stock is kept to a reasonable standard.

Dimension L	Bending Moment	Shear
up to 3.6m	2.0	1.67
from 3.6m to 67	$0.73 + 2.16/L^{0.5} - 0.2$	$0.82 + 1.44/L^{0.5} - 0.2$
over 67	1.0	1.0

The dynamic factor for RL loading, when evaluating moments and shears, shall be taken as 1.20, except for unballasted tracks where, for rail bearers and single-track cross girders, the dynamic factor shall be increased to 1.40. The dynamic factor applied to temporary works may be reduced to unity when rail traffic speeds are limited to not more than 25 km/h.

□ **Include lurching effect** Lurching results from the temporary transfer of part of the live loading from one rail to another, the total track load remaining unaltered. The dynamic factor applied to RU loading will take into account the effects of lurching, and the load to be considered acting on each rail shall be half the track load.

Notes.

- The dynamic factor applied to RL loading will not adequately take account of all lurching effects. To allow for this, 0.56 of the track load shall be considered acting on one rail concurrently with 0.44 of the track load on the other rail. This distribution of load need only be taken into account on one track where members support two tracks. Lurching may be ignored in the case of elements that support load from more than two tracks.
- Train loads will be generated about the centre point.

United States of America Vehicle Loading

USA vehicle loads can be defined for:

- Truck loads **AASHTO LFD and LFRD loading and other state dependent design loading such as Oregon LRFR. and West Virginia Department of Transportation Truck Loading**
- Tandem loads **based on AASHTO LFRD**
- Uniform loads **based on AASHTO LFD and LRFD**
- Concentrated Pm loads **based on AASHTO LFD**
- Concentrated Ps loads **based on AASHTO LFD**
- Train loading **based on AREMA**

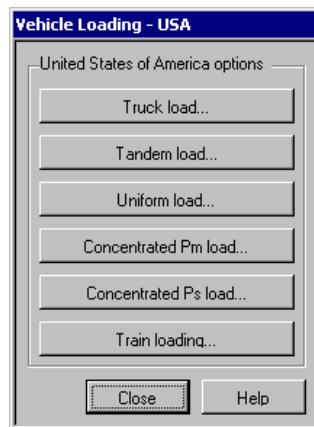

See [Using static vehicle loadings](#) for details regarding defining and assigning static vehicle loadings.

United States of America Truck Loading

The truck load generator produces vehicle loads based on:

AASHTO LFD and AASHTO LRFD codes and other state dependent codes such as Oregon LRFR and West Virginia.

AASHTO LFD Truck Loading

For the AASHTO LFD code the following truck types can be created: H15, H20, HS15, HS20 and HS25. For the HS15, HS20 and HS25 the variable axle spacing can be set between 14ft and 30 ft. For all the trucks the additional impact factor can be added to the loads based on loaded length.

Truck Load

Vehicle data

Design code: AASHTO LFD

Vehicle load: H15

Axle spacing, V (ft): 14

Apply a double axle trailer

AASHTO vehicle load H15
total weight 30 000 lbs.

Axle spacings are in feet

14

0.1w, 0.1w, 0.4w, 0.4w

AASHTO LFD impact factor

Include impact factor

Length for computing impact factor (ft)

AASHTO LRFD dynamic load allowance

Include dynamic load allowance

Dynamic load allowance - IM: 75

OK Cancel Apply Help

AASHTO LFD Truck Loading

For the AASHTO LRFD code the design truck that forms part of the HL-93 loading can be created. For the design truck the additional dynamic load allowance can be added to the loads based on the impact factor (IM).

To use either loading type:

- Choose the design code that the truck load is to be calculated from.
- Choose the vehicle type required to be generated. Note that if axle spacing is required this has to be between 14 and 30 feet for the **AASHTO LFD** vehicles and 14 and 32 feet for the **AASHTO LRFD** design truck. The vehicle will be generated about its centroid.

For **AASHTO LFD**'s **H20** and **HS20** the option to have a double axle trailer is possible. This is applicable for timber or orthotropic steel decks (excluding transverse beams). For these vehicles either one 32 000 lbs or two 16 000 lbs four feet apart axles can be used. The vehicle giving the most adverse effect should be used for design.

For **AASHTO LFD**, if an impact factor is to be considered, select the check box and enter a length for computing the **impact factor**. The impact allowance is a maximum of 30 % making the impact factor a maximum of 1.3. The impact factor is calculated from the equation below.

$$I = 50 / (L + 125)$$

where L = length for computing the impact factor in feet

For **AASHTO LRFD** what was known as impact in the Standard Specification is called **dynamic load allowance (IM)** in the LRFD Specification and is expressed as a percentage. The base dynamic load allowance factors are present in LRFD Table 3.6.2.1-1. Designers should note that the base values are reduced for buried components and for wood structures.

Oregon LRFR Truck Loading

See [Oregon Department of Transportation Truck Loading](#)

West Virginia Truck Loading

See [West Virginia Vehicle Loading](#)

United States of America Tandem Load (AASHTO LRFD)

The tandem load generator produces load groups based on the AASHTO LRFD code.

For the AASHTO LRFD code the tandem load that forms part of the HL-93 loading can be created. For the tandem load the additional dynamic load allowance can be added to the loads based on the impact factor (IM).

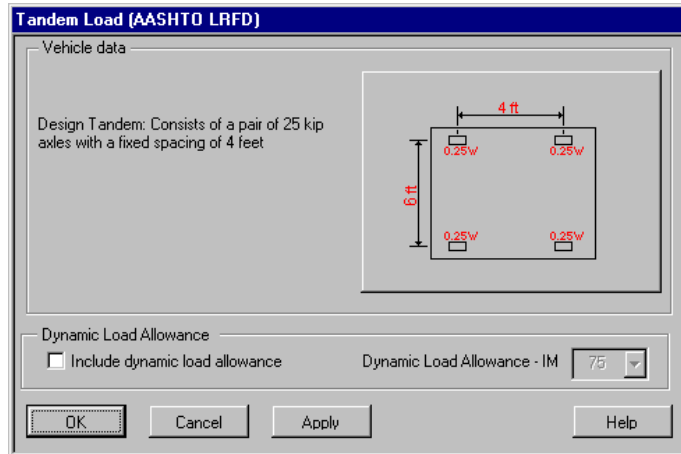

For AASHTO LRFD what was known as impact in the Standard Specification is called dynamic load allowance (IM) in the LRFD Specification and is expressed as a percentage. The base dynamic load allowance factors are present in LRFD Table 3.6.2.1-1. Designers should note that the base values are reduced for buried components and for wood structures.

United States of America Lane Load (AASHTO)

The lane load generator produces a uniform patch load based on the AASHTO LFD and AASHTO LRFD codes.

For the AASHTO LFD code the following load types can be created: H15, H20, HS15, HS20 and HS25. For all the load types the additional impact factor can be added to the loads based on loaded length.

For the AASHTO LRFD code the design lane load that forms part of the HL-93 loading can be created. For the design lane load the additional dynamic load allowance can be added to the loads based on the impact factor (IM).

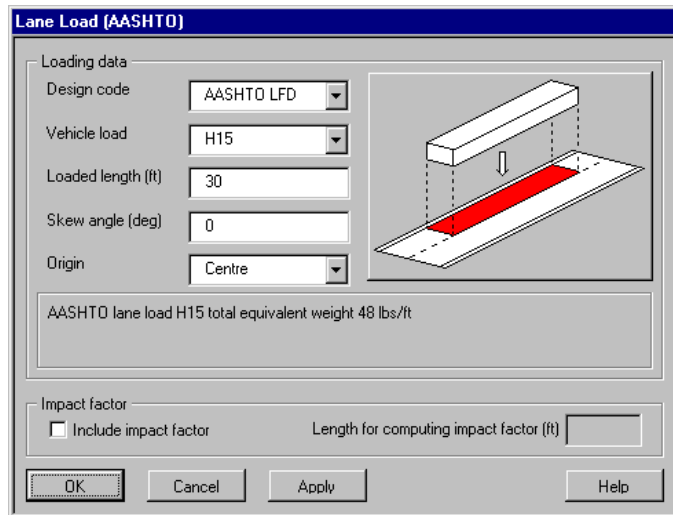

To use this loading type:

- Choose the design code that the lane load is to be calculated from.
- Choose the patch type from the drop down list to specify the load intensity.
- Specify the length of lane load that you require to generate about the centre line of patch.
- Specify the skew angle to apply to the lane loading (clockwise positive).
- Choose the origin that the load will be generated about.

For AASHTO LFD, if an impact factor is to be considered, select the check box and enter a length for computing the impact factor. The impact allowance is a maximum of 30 % making the impact factor a maximum of 1.3. The impact factor is calculated from the equation below.

$$I = 50 / (L + 125)$$

where L=length for computing the impact factor in feet

United States of America AASHTO Knife Edge Load (Moment, Pm)

The knife edge load (moment, Pm) generator produces a line load based on the AASHTO LFD code.

For the AASHTO LFD code the following load types can be created: H15, H20, HS15, HS20 and HS25. For all the load types the additional impact factor can be added to the loads based on loaded length.

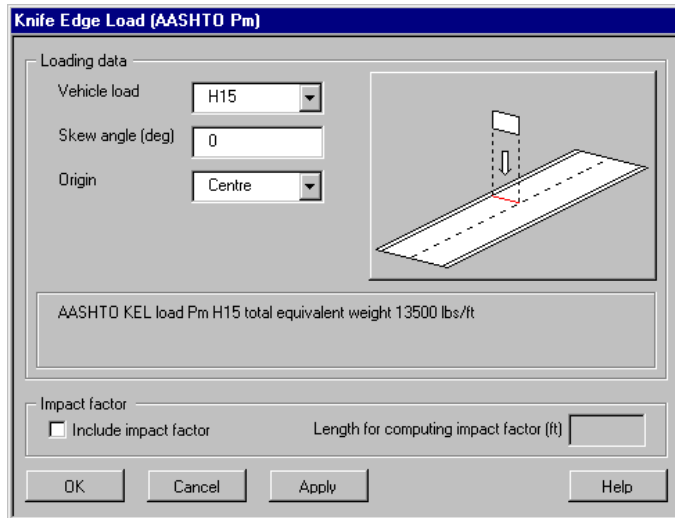

To use this loading type:

- Choose the vehicle load type from the drop down list.
- Specify the skew angle to apply to the KEL loading (clockwise positive).
- Choose the origin for which the load is to be generated about.
- If an impact factor is to be considered, select the check box and enter a length for computing the impact factor. The impact allowance is a maximum of 30 % making the impact factor a maximum of 1.3. The impact factor is calculated from the equation below.

$$I = 50 / (L + 125)$$

where L=length for computing the impact factor in feet

United States of America AASHTO Knife Edge Load (Moment, Ps)

The knife edge load (moment, Ps) generator produces a line load based on the AASHTO LFD code.

For the AASHTO LFD code the following load types can be created: H15, H20, HS15, HS20 and HS25. For all the loads types the additional impact factor can be added to the loads based on loaded length.

To use this loading type:

- Choose the vehicle load type from the drop down list.
- Specify the skew angle to apply to the KEL loading (clockwise positive).
- Choose the origin for which the load is to be generated about.
- If an impact factor is to be considered, select the check box and enter a length for computing the impact factor. The impact allowance is a maximum of 30 % making the impact factor a maximum of 1.3. The impact factor is calculated from the equation below.

$$I = 50 / (L + 125)$$

where L=length for computing the impact factor in feet

United States of America Train Loading – AREMA

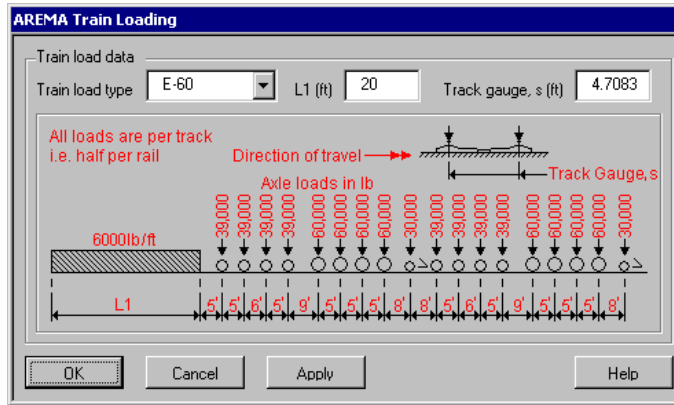

To create this loading type:

- Select the standard rail loading type from the drop down list.
- Enter the dimensions L1 as appropriate for the load model chosen.
- Enter the track gauge.

For this loading a number of discrete load attributes will be created that are used to define a compound load. It is the compound load that should be assigned to the model.

Oregon Department of Transportation Truck Loading

Oregon vehicle loadings are accessed from the **Bridge > Bridge Loading > United States of America > Truck Load...** menu item.

Oregon vehicle loadings are defined to Oregon Department of Transportation specification (ODOT LRFR Manual, 2008). They include the following types:

- ODOT Continuous Trip Permit (CTP) Trucks
- ODOT Legal Trucks (LEG)
- ODOT Permit Load (PERMIT) Trucks
- ODOT Single Trip Permit (STP) Trucks
- Specialized Hauling Vehicles (Denoted as SU Trucks)

For all vehicle types all axle loadings and axle spacings are set. No user input is required.

See [Using static vehicle loadings](#) for general details regarding static vehicle loadings.

Continuous Trip Permit (CTP) Trucks

The designations for ODOT permit vehicles contain indicators of the type Continuous Trip Permit (CTP) or Single Trip Permit (STP), and the number of the MTC weight table it represents. For example, "Type CTP-2A" indicates a Continuous Trip Permit vehicle that conforms to Weight Table 2.

Truck Load

Vehicle data

Design code: Oregon LRFR

Vehicle load: OR-CTP-2A

Axle spacing, V (ft):

Apply a double axle trailer

Indicated concentrated loads are axle loads in kips
Axle spacings are in feet

← Direction of travel

10.5 16.5 16.5 14 14 14 10 10

17 4.5 29 4.5 4.5 18 4.5

82

AASHTO LFD impact factor

Include impact factor Length for computing impact factor (ft):

AASHTO LRFD dynamic load allowance

Include dynamic load allowance Dynamic load allowance - IM: 75

OK Cancel Apply Help

The following Continuous Trip Permit (CTP) Trucks are provided:

- OR-CTP-2A
- OR-CTP-2B
- OR-CTP-3

ODOT Legal Trucks (LEG)

Truck Load

Vehicle data

Design code: Oregon LRFR

Vehicle load: OR-LEG-3

Axle spacing, V (ft):

Apply a double axle trailer

Indicated concentrated loads are axle loads in kips
Axle spacings are in feet

AASHTO LFD impact factor

Include impact factor Length for computing impact factor (ft):

AASHTO LRFD dynamic load allowance

Include dynamic load allowance Dynamic load allowance - IM: 75

OK Cancel Apply Help

The following Legal Trucks (LEG) are provided:

- OR-LEG-3
- OR-LEG-3-3
- OR-LEG-3-3 TRAIN
- OER-LEG-3S2

ODOT Permit Load (PERMIT) Trucks

Truck Load

Vehicle data

Design code: Oregon LRFR

Vehicle load: OR-PERMIT1

Apply a double axle trailer:

Indicated concentrated loads are axle loads in kips
Axle spacings are in feet

← Direction of travel

12 21.5 21.5 21.5 21.5

10 4 24 4

42

AASHTO LFD impact factor

Include impact factor Length for computing impact factor (ft)

AASHTO LRFD dynamic load allowance

Include dynamic load allowance Dynamic load allowance - IM 75

OK Cancel Apply Help

The following Permit (PERMIT) Trucks are provided:

- OR-PERMIT1
- OR-PERMIT2
- OR-PERMIT3
- OR-PERMIT4
- OR-PERMIT5
- OR-PERMIT6
- OR-PERMIT7

ODOT Single Trip Permit (STP) Trucks

The designations for ODOT Permit Vehicles contain indicators of the type of Continuous Trip Permit (CTP) or Single Trip Permit (STP) and the number MTCD Weight Table it represents. For example, “Type STP-4A” indicates this is a Single Trip Permit vehicle that conforms to Weight Table 4.

Truck Load

Vehicle data

Design code: Oregon LRFR

Vehicle load: OR-STP-3

Axle spacing, V (ft):

Apply a double axle trailer

Indicated concentrated loads are axle loads in kips
Axle spacings are in feet

← Direction of travel

13 21.5 21.5 21.5 21.5

17 4.5 29 4.5 15

70

AASHTO LFD impact factor

Include impact factor Length for computing impact factor (ft)

AASHTO LRFD dynamic load allowance

Include dynamic load allowance Dynamic load allowance - IM 75

OK Cancel Apply Help

The following Single Trip Permit (STP) Trucks are provided:

- OR-STP-3
- OR-STP-4A
- OR-STP-4B
- OR-STP-4C
- OR-STP-4D
- OR-STP-4E
- OR-STP-5BW

Specialized Hauling Vehicles (denoted as SU Trucks)

Truck Load

Vehicle data

Design code: Oregon LRFR

Vehicle load: SU4 Truck

Axle spacing, V (ft):

Apply a double axle trailer

Indicated concentrated loads are axle loads in kips
Axle spacings are in feet

← Direction of travel

12 8 17 17

10 4 4

18

AASHTO LFD impact factor: Include impact factor Length for computing impact factor (ft):

AASHTO LRFD dynamic load allowance: Include dynamic load allowance Dynamic load allowance - IM: 75

OK Cancel Apply Help

The following Specialized Hauling Vehicles (denoted as SU Trucks) are provided:

- OR-SU4 Truck
- OR-SU5 Truck
- OR-SU6 Truck
- OR-SU7 Truck

West Virginia Department of Transportation Truck Loading

West Virginia vehicle loadings are accessed from the **Bridge > Bridge Loading > United States of America > Truck Load...** menu item. They include the following types:

- SU40 Truck
- SU45 Truck
- 3S55 Truck
- 3S60 Truck

- Tandem Truck
- Five Axle Semi Truck
- Six Axle Semi Truck
- T3 Truck
- 3S2 Truck

For all vehicle types all axle loadings and axle spacings are set. No user input is required.

See [Using static vehicle loadings](#) for general details regarding static vehicle loadings.

The screenshot shows the 'Truck Load' dialog box with the following details:

- Vehicle data:**
 - Design Code: West Virginia
 - Vehicle load: Five Axle Semi
 - Text box: West Virginia vehicle load Five Axle Semi total weight 80000 lbs.
 - Input field: Axle Spacing, V (ft)
 - Checkbox: Apply a double axle trailer
- Diagram:**
 - Direction of travel: ←
 - Indicated concentrated loads are axle loads in kips
 - Axle spacings are in feet
 - Diagram shows a horizontal line representing the truck's path with five downward arrows representing axle loads. The first arrow is labeled '10'. The next two arrows are labeled '25' and '25'. The final two arrows are labeled '25' and '25'. Horizontal dimensions below the line show a 16' spacing from the first axle to the second, a 4' spacing between the second and third axles, a 24' spacing between the third and fourth axles, and a 4' spacing between the fourth and fifth axles. A total dimension of 49' is shown from the first to the fifth axle.
- AASHTO LFD impact factor:**
 - Checkbox: Include impact factor
 - Text: Length for computing impact factor (ft)
 - Input field: []
- AASHTO LRFD dynamic load allowance:**
 - Checkbox: Include dynamic load allowance
 - Text: Dynamic load allowance- IM
 - Dropdown menu: 75
- Buttons:** OK, Cancel, Apply, Help

Moving Load Generator

Overview

The moving load generator is accessed from the **Bridge> Moving Load...** menu item. It is used to track the path of a vehicle (or a set of vehicles) across a structure by automatically setting up a number of static loadcases at prescribed locations along a selected line. These loadcases produced can then be enveloped to provide the maximum effect of the vehicle passing over the structure.

Prior to using the moving load generator a slab or grillage model that will allow the application of discrete loads must have been created. Ensure that the discrete load group representing the vehicle to be moved across the structure has been defined in the  Treeview and that a line representing the vehicle path across the structure has been defined and selected. The line representing the vehicle path should not be one of the lines forming the model. If a combined line is selected then the generator will use the points joining the lines within the combined line as the locations for the application of the vehicle loads. For straight lines or arcs the generator will split the selected line representing the vehicle path into a number of segments and create a loadcase for the vehicle in each load position. Only the first line within the selection will be processed.

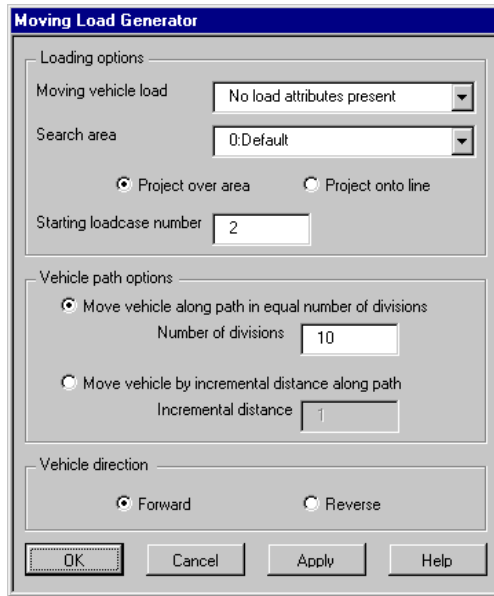

- Moving vehicle load** Select the pre-defined vehicle load to be moved along the line
- Search area** can be used to restrict the area of application of point and patch loads to pre-defined part of the model. Generally, for grillage models, a search area is not required.
- Project over area** needs to be selected if the vehicle load is to be applied to a grillage or slab model (3D)
- Project onto line** needs to be selected if the load is to be applied to a line beam model (2D)
- Starting loadcase number** can be set to whatever loadcase number is required but by default will be set to be the next free loadcase number.
- Vehicle path options** define whether the vehicle is to be moved across the structure by an equal number of divisions or by an incremental distance of the line representing the vehicle path.
- Vehicle direction** allows for forward (defined by the geometric line direction) and reverse passing of the loading.

Load direction

When moving a discrete load where the load direction and the projection vector do not match care should be taken in the direction of the discrete load to ensure that the loading applies in the correct direction along the path. For all vehicles defined using the Bridge > Bridge Loading menu item the front of the vehicle and local axes are defined as follows:

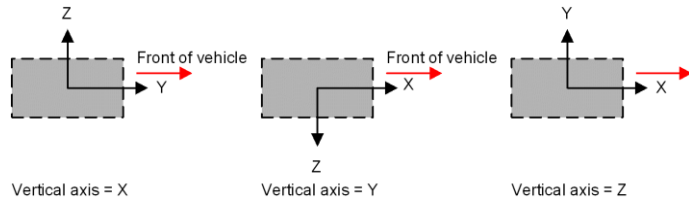

Centrifugal loading

When a centrifugal load is defined for use on a path represented by an arc the point or patch load direction and sign of the vehicle load should be set up to take account of the vertical axis of the model and of the local axes of the vehicle.

Patch loading

In the following patch load example the vertical axis of the model is set to the Y direction and a vehicle load is moved clockwise around an arc in the ZX plane with centrifugal loading defined as a negative value in the Z direction:

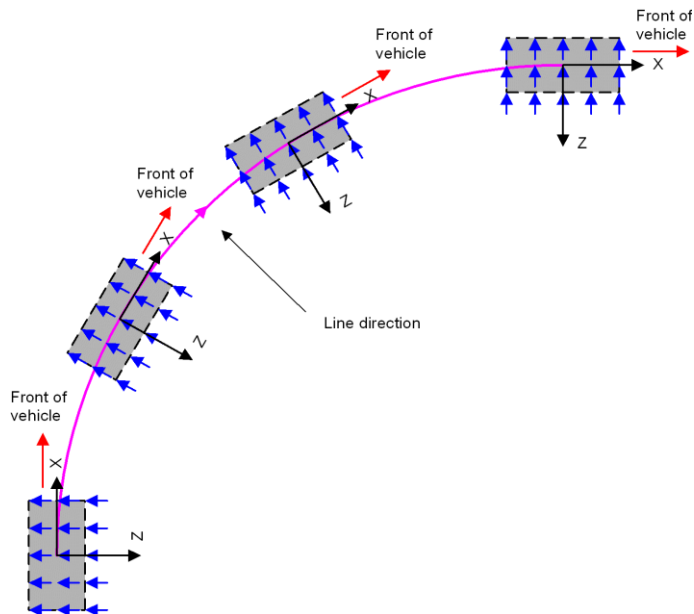

Reversing the vehicle direction by using the Reverse option on the Moving Load dialog will change the orientation of the vehicle configuration so it is rotated 180 degrees such that the vehicle will now pass along the path in the opposite direction with this new orientation. Loads defined in the lateral vehicle directions will be rotated ensuring that the lateral loads for centrifugal loading will be maintained in the correct direction as the vehicle passes along the path.

The following examples (using trapezoidal-shaped patch loading for clarity) show the effect of vehicle direction upon any horizontally defined longitudinal or centrifugal loads:

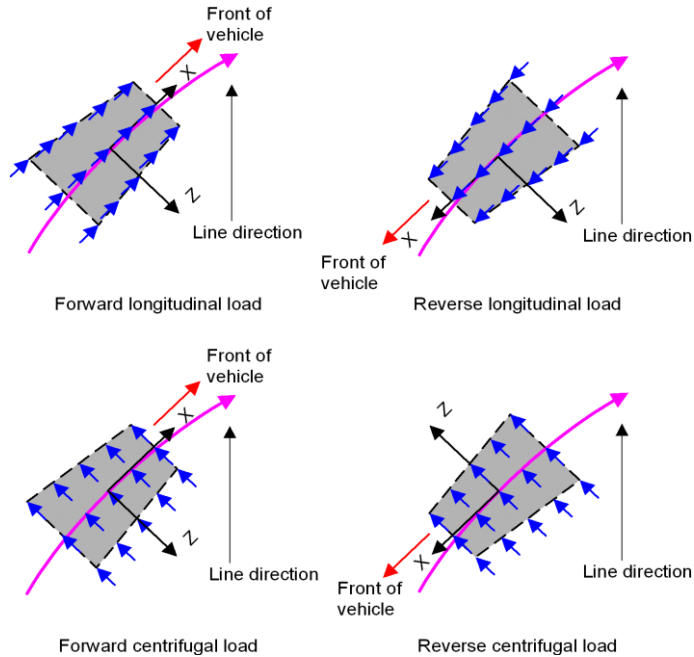

Point loading

For point loading similar care should be taken to ensure that the vertical axis of the model and the untransformed load directions for longitudinal or centrifugal loading are compatible. Reversing the vehicle direction by using the Reverse option on the Moving Load dialog will ensure that any lateral loads are rotated and, as for patch loading, the centrifugal loading will be maintained in the correct direction as the point load passes along the path.

Moving multiple loads

Discrete loads can be assigned to, and manipulated on a model as a load set or load train by creating a **compound discrete load**. See the Modeller User Manual for details.

Pedestrian Loading

Overview

Pedestrian loading scripts can be accessed from the **Bridge> Pedestrian Loading...** menu item. These example scripts (that are supplied as-is) provide the ability to apply vertical oscillating pedestrian loading to a structural model in accordance with the following design codes:

- ❑ **BD37/01** - Design Manual for Roads and Bridges, Volume 1, Section 3, Part 14, Appendix B.
- ❑ **BS EN 1991-2 2003** NA to BS EN 1991-2 2003 cl NA.2.44.4 'Dynamic actions representing the passage of single pedestrians and pedestrian groups.'

For more information on how to access this menu item please contact LUSAS Technical Support.

Vehicle Load Optimisation

Overview

Vehicle Load Optimisation is provided for use with selected Bridge software products only, and only for licences that support this facility.

Vehicle load optimisation (VLO) makes use of influence surfaces and [influence analysis](#) to identify the most onerous vehicle loading patterns on bridges for a chosen design code and to apply these loading patterns to LUSAS models. It reduces the amount of time spent generating loadcases to replicate design code-based traffic and lane loading on models and leads to more efficient and economic design, assessment or load rating of bridge structures. It can be applied to grillage, line beam and plate/shell models.

Two influence analysis methods are available: the Reciprocal Method and the Direct Method. This general overview of VLO applies to both except where stated.

Performing a vehicle load optimisation analysis

Once a structural model is built, the stages required to evaluate the effect of the most onerous vehicle loading patterns on a bridge using Vehicle Load Optimisation analysis are shown below. A simple plate/shell model for analysing traffic loading to Eurocode EN-1991-2 for a number of indicative mid-span influence points is shown to illustrate the stages involved.

Stage 1: Assign Influence Attributes to a model

Before running a Vehicle Load Optimisation analysis [influence attributes](#) must have been assigned to selected positions (nodes or points of interest) on a model. Kerb lines defining the extent of the carriageway need to be defined. These are normally added by drawing lines and arcs to represent the kerb locations.

See [Influence Attributes](#) for more details.

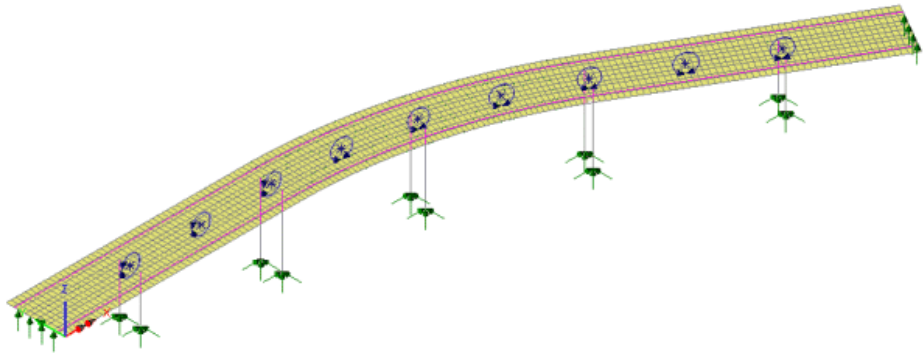



Stage 2: Optional Solve to view influence shapes

Before running a Vehicle Load Optimisation analysis an **influence analysis** can be optionally run to investigate the influence lines or surfaces for the assigned influence attributes. An influence surface for each influence position is automatically calculated and can be optionally displayed. Note that influence shapes can also be viewed after a successful VLO analysis has been carried out.

Viewing of influence shapes

After an influence analysis has been carried out the influence shape for each influence point of interest can be seen by setting each influence loadcase active, in turn, in the Analyses  Treeview.

The influence shape can be viewed on the **Influence shape** layer in the Layers  Treeview. Note that this layer replaces the Deformed mesh layer when an influence analysis loadcase is active. It cannot be added to the Layers  Treeview manually.

By adding a Contours layer to the Layers  Treeview contours of **Influence result** (Direct Method only) can be displayed. By referring to the contour key regions of the model where positive or negative loading effects take place can be seen.

Note: When a Direct Method influence analysis has been solved for one assigned attribute the effect of a unit load on any part of the structure can be seen immediately for any subsequently assigned influence attributes.

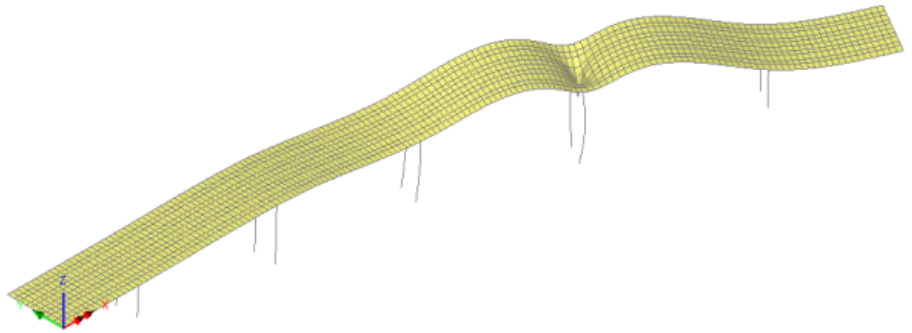

See **influence analysis** for more details.





Stage 3: Running a Vehicle Load Optimisation Analysis

Running the Vehicle load optimisation facility requires the selection of a design code, and specifying the influence lines to be used, and the selection of the kerb lines to be used to limit the placement of vehicle loading patterns, and whether loading patterns should be created. It interrogates each influence surface and calculates the critical loading pattern for the chosen effect. Once run, the critical loading pattern can be optionally displayed prior to calculating the effects of the loading on the model.

A successful analysis will add a Reciprocal Influence or a Direct Method Influence Analysis entry (depending upon influence attributes used) as well as a VLO Analysis entry (and VLO runs) to the Analyses  Treeview. These entries permit viewing of influence shapes and traffic loading patterns prior to solving the model for those loading patterns.

Any number of VLO Analysis entries can be created in the Analyses  Treeview. Each VLO Analysis entry can contain any number of  VLO runs, with each run containing loadcases generated by the vehicle load optimisation software according to the chosen design code and associated settings chosen. Each loadcase comprises vehicle and lane loadings appropriate to the design code selected that, when solved, will generate the most adverse positive or negative loading effect for each of the influence points of interest, as defined on the model. If desired, it is possible to set-up one VLO run to investigate Positive effects and a separate run to investigate Negative effects, or they can be combined into one run, all within the same Analysis. VLO runs can be copied and pasted between different VLO analyses.

Viewing of vehicle loading patterns

By turning on the display of loading  and setting each loadcase active in the Analyses  Treeview, the vehicle loading pattern for each loadcase generated by the vehicle load optimisation wizard can be viewed.

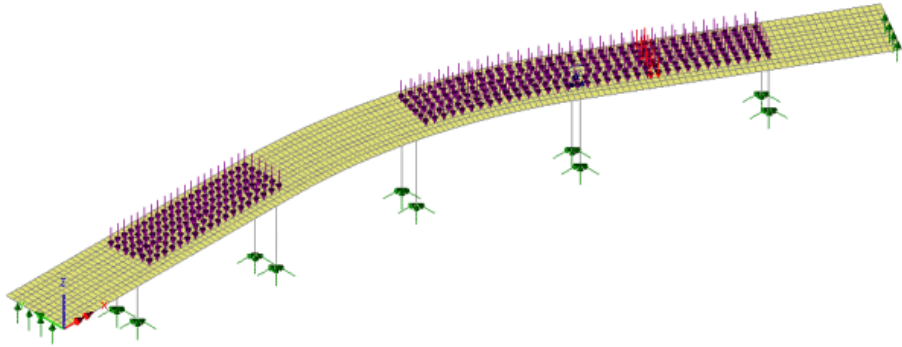

By expanding each loadcase's loading entry, the individual loading types and their corresponding load factors that make-up each loadcase can be seen. Context menu items provide additional visualisation and other options.

For a detailed explanation of how to use the Vehicle Load Optimisation facility see the [Vehicle Load Optimisation Wizard](#).



Stage 4: Solve to calculate the effects of traffic loading on the structure

After running a Vehicle Load Optimisation analysis the model must be solved to calculate the effect of the critical loading patterns on the model. Critical loading patterns can be optionally superimposed on deformed or undeformed results plots.

With influence result loadcases and loadcases representing the critical traffic loading patterns present in the Analyses  Treeview, pressing the Solve button  on the main toolbar menu will analyse the effect of these loadings on the structure.

It is also possible to choose the **Solve Now** menu item on context menu of individual analysis entries. Loadcases can also be solved selectively by choosing the **Loadcase to Solve** context menu item.

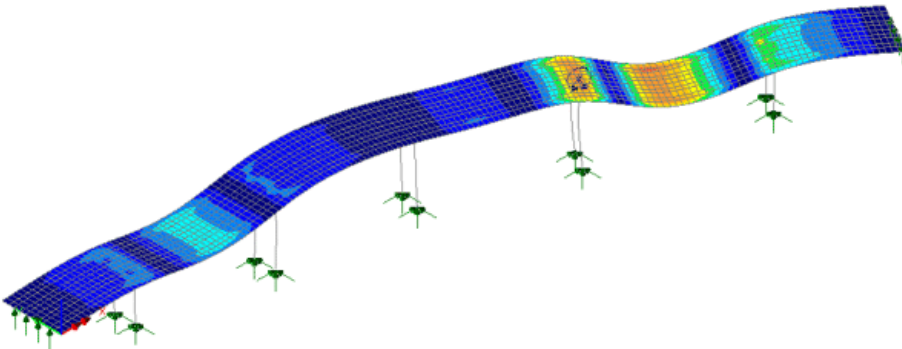

Note: For a line beam model, where the geometric section represents a beam with a loadable top slab, a loadable grid of points is used to represent the slab. See [Direct Method Influence Attributes](#) for more details.

Updating and re-running a vehicle load optimisation analysis

Editing an existing VLO Run entry in the Layers  Treeview to include more influences will delete and re-create existing influences as well as add new results loadcases for the additional influences.

Superposition

Vehicle Load Optimisation software supported by LUSAS inherently uses the principal of linear superposition. In a linear static analysis this assumption holds true for all results components that are calculated by a LUSAS Solver, but note that it does not hold true for some results components that are post-processed by LUSAS Modeller. For example, Wood Armer calculations are not linear calculations, therefore superposition is not safe for these. Similarly, the definition of any user-defined results components (that can be used in the definition of a Direct Method influence) may include equations with terms or constants that are not scalable.

Viewing Results

See [Visualising the Results](#).

Vehicle Load Optimisation Wizard

Vehicle Load Optimisation is provided for use with selected Bridge software products only, and only for licences that support this facility.

The vehicle load optimisation wizard can be accessed from the **Analyses > Bridge > Vehicle Load Optimisation** menu item. It provides the means of defining parameters, for a particular design code, to generate the most critical traffic loading pattern for each influence shape under consideration. Prior to accessing the Vehicle Load Optimisation wizard to run an VLO analysis [influence attributes](#) must have been assigned to selected nodes or points of interest on a model. Kerb lines defining the extent of the carriageway also need to be defined or selected.

See [Vehicle Load Optimisation Explained](#) for a general general description of how to carry out a vehicle load optimisation analysis. [Worked Examples](#) illustrate the steps involved in carrying out different types of vehicle load optimisation.

Notes:

- A model can be defined in any quadrant of the Modeller view window. For example in positive x, positive y, or in negative x, positive y.

- Vehicle loads can be projected in either the X, Y or Z directions, meaning that models can lie in any of the primary (X,Y), (Y,Z) or (Z,X) planes, noting that non-planar decks are also supported.
- When using shells, quadratic elements with mid-side nodes are permitted.

Design codes supported by LUSAS Traffic Load Optimisation

Vehicle Load Optimisation

Loading options

Country: Europe [v] Optional code settings...

Design code: EN1991-2 Recommended Values 2009 [v] Optional loading parameters...

Solution process

View onerous effects table Define carriageways...

Create loading patterns Set influence surfaces...

All chosen influences Most onerous

Analysis: VLO Analysis 2 [v]

Name: VLO Run 1

Note that the model will be saved when OK is pressed

OK Cancel Help

Country design codes currently supported by the LUSAS Traffic Load Optimisation facility include:

- Australia** - [AS5100-2:2004](#) and [AS5100-7: 2004 \(Austroads\)](#)
- Canada** - [CAN/CSA-S6-06 \(Design\)](#)
- China** - [JTG D60-2015](#)
- Denmark** - [DS/EN 1991-2 DK NA:2015](#)
- Europe** - [Eurocode EN1991-2 Recommended values](#)
- Finland** - [LO 24/2014 Application of the Eurocode - Bridge loads and design criteria - NCCI 1](#)
- Ireland** - [Eurocode EN1991-2](#)
- Italy** - [Eurocode EN1991-2](#)
- New Zealand** - [Transit New Zealand Bridge Manual \(SP/M/022 2nd and 3rd Edition\)](#)
- Norway** - [EN1991-2 Norway 2010 + NA-rundskriv 07-2015](#)
- Poland** - [Eurocode EN1991-2](#)

- ❑ **Sauda Arabia** - [MOMRA Bridges Design Specifications](#)
- ❑ **Sweden** - [Eurocode EN1991-2 \(2009\)](#)
- ❑ **Sweden** - [Eurocode EN1991-2 \(2011\)](#)
- ❑ **Sweden** - [TDOK 2013:0267 Version 3.0](#) - Bärighetsberäkning av broar. UHabb January 2016.
- ❑ **United Kingdom** - [Eurocode EN1991-2](#)
- ❑ **United Kingdom** - Highways Agency Departmental Standard [BA34/90](#) “Design Manual for Roads and Bridges, Volume 3, Section 4, Part 17: BA34/90 (and BD34/90) Technical Requirements For The Assessment And Strengthening Programme For Highway Structures, last updated Sept 1990.
- ❑ **United Kingdom** - Highways Agency Departmental Standard [BD21/01](#) “Assessment of Highway Bridges and Structures”.
- ❑ **United Kingdom** - Highways Agency Departmental Standard [BD21/01 Annexes D and E](#) “Assessment of Highway Bridges and Structures”.
- ❑ **United Kingdom** - [BS5400-2:1978](#) Steel, concrete and composite bridges Part 2: Specification for Loads, incorporating Amendment No 4209. British Standards Institution, March 1983.
- ❑ **United Kingdom** - Design Manual for Roads and Bridges, Volume 1, Section 3, Part 14: [BD37/01](#) Loads For Highway Bridges, last updated May 2002
- ❑ **United Kingdom** - Highways Agency Departmental Standard [BD86/11](#) “Loads for Highway Bridges”, which incorporates BS5400 Part 2:1978.
- ❑ **United States of America** [AASHTO LRFD \(7th and 6th Edition\)](#), and [AASHTO Standard Specifications \(17th Edition\)](#).

Note: For the Eurocode EN1991-2 **Recommended values** option the values for Nationally Determined Parameters (α_0 , α_q , ψ) and the EN1991-2 informative Annex A Special Vehicles are used by default.

Editing of the supplied traffic load optimisation design files (to vary axle loads, transverse wheel spacing, axle spacing or add/delete axles etc.) is not permitted. But the supplied files for a particular design code may be copied to a specifically named user folder (which is read automatically each time the VLO dialog is presented), then be edited as required. Subsequent opening of the VLO dialog will list those user-defined design codes as a 'User' code alongside the LUSAS supplied design codes. For more information contact LUSAS technical support.

Other design codes supported

For the Republic of South Africa, the TMH7 Loading standard is supported by the Autoloader Vehicle Load Optimisation software option. Please contact LUSAS technical support if you wish to use this legacy facility.

Optional Code Settings

Optional code settings can be specified for all design codes supported. Click on the country links above for each country, see the online help dialogs for each country load type for details, or refer to the relevant help pages in the *Application Manual (Bridge, Civil & Structural)*.

Optional Loading Parameters

The following parameters are available for selection:

- Longitudinal increment** specifies the increment used when moving the abnormal vehicle along the carriageway. The smaller the increment, the more accurately the effect of the vehicle across the structure is calculated, giving more accurate results. A larger increment gives quicker TLO runs, but with less accuracy. A generally suitable default value is provided, but users can specify an alternative value based upon experience.
- Transverse increment** specifies the increment to be used when positioning the vehicle across the carriageway. The smaller the increment, the more accurately the effects of the vehicle across the structure are calculated, giving more accurate results. A larger increment gives quicker TLO runs but with less accuracy. Care should be taken to ensure that the transverse increment stated will enable a load to sit up against a kerb for certain lane types. A generally suitable default value is provided, but an alternative value can be specified as necessary.
- Vehicle Direction** specifies the vehicle direction which is used to calculate the effects of each vehicle. Vehicle axles are defined from the leading axle. **Forward** means the vehicle is run in a forward direction along the carriageway from the starting point of the carriageway. **Reverse** means the vehicle is run with the normally trailing axle leading along the carriageway from the starting point of the carriageway. **Both** means both cases are run. For an asymmetric vehicle, either forward or reverse could produce the greatest effect, dependent upon the shape of the influence surface and the increments used. The default is both directions.

Defining Carriageways

Lines defining the width of the carriageway must be present in the model and selected. Where lines already represent the edges of a structure, or the centreline of a carriageway, lines representing the width of a carriageway can be easily added using the **Geometric> Line> By offsetting** menu item. Note that these lines do not have to form a structural part of the model. Once done the following parameters are available for selection:

- Kerb positions** - define the width of each carriageway. Note that it is not possible to define kerb positions via tabular input.

- **Kerb from Selection** - The kerb positions of carriageways are defined by selecting those lines defining the kerbs on either side of a carriageway in the view window prior to accessing the Vehicle Load Optimisation dialog. Straight lines, arcs or a combination of these two feature types can be used and selected to describe the extent of the carriageway. Multiple sets of carriageways can be defined by selecting multiple sets of those lines defining the extent of each carriageway.

Permissible kerb arrangements

- Pairs of straight lines defining kerb positions must be parallel, and the start and end points of each kerb must be orthogonally opposite each other.
- Pairs of arcs defining kerb positions must be concentric and have the same subtended angle
- Consecutive straight lines and arcs can be used to define kerb positions but opposite pairs of lines that define the kerb positions must be of the same type, that is, either both straight lines or both arcs, and not a mixture. Consecutive straight lines and arcs must be tangential. Using only consecutive straight lines to define kerb positions is invalid unless the intersection points are filleted.
- Kerb lines should lie in a common plane. For bridge decks with a variable longitudinal vertical profile (such as a vertically curved deck) a primary (X,Y), (Y,Z) or (Z,X) plane must be used. For bridge decks with a constant longitudinal vertical profile (such as a horizontal or inclined bridge deck) the kerb lines may lie in a primary plane or in the same plane as the bridge deck.
- Kerb lines must be transversely within the limits of any Direct Method Influence grid, if one is used during influence attribute assignment.

Valid kerb arrangements showing the resulting loadable regions in darker shading are shown:

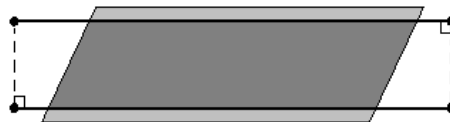

Straight kerbs



Curved kerbs

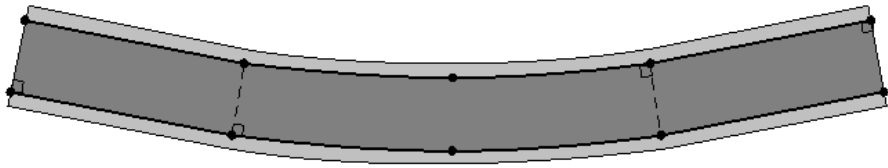

Straight and curved kerbs - opposing pairs of lines and arcs are of the same type)

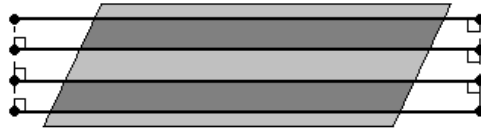

Definition of multiple sets of carriageways

Setting-up Influence Surfaces

- The **List of available influences** shows all assigned **influence attributes** for the model. These can be included in a vehicle load optimisation analysis en-mass, or by individual selection.



The following additional settings can be made:

- Include all influence surfaces** - selects all the influence surfaces in the model for use in the vehicle load optimisation.
- Magnification factor** (for AASHTO LRFD 7th Edition Louisiana (June 2016) only) is provided if the option “Apply magnification factor (LADV-11 loading)” is chosen from the Optional Code Settings dialog. A different magnification factor is needed for each influence because it depends on the span length, and on whether the influence is Positive moment, Negative moment, Shear, Bearing reaction, Factored support reaction or Service support reaction, as per LRFD Bridge Design Manual No 2 (June 2016) table in section A.3.6.1.2.
- L (m)** (for Sweden TDOK 2013:0267, some Sweden rail codes, and EN1991-2 Denmark 2015 only) This is an option to introduce the length (in model units) of the influence used. For use in calculation of the dynamic factor.
- Positive** and/or **Negative** Vehicle loading can be placed on either Positive or Negative areas by checking the Positive or Negative (or both) checkboxes for each of the included influences. Note that clicking in the header cell of a column will select the whole column so that checking (ticking) one entry in the column will check (tick) all entries in that column. Selection of multiple columns is also possible.
- Alternative load pattern** (for AASHTO LFD Standard Specifications clause 3.11.3, AASHTO LRFD clause 3.6.1.3.1, and Korean lane loads on continuous spans only). When the column is checked, the influence surface referred to in



that row of the grid will be treated as set out in the clauses mentioned above - an option suitable for negative moments between points of contraflexure or reactions of interior piers. Checking the box will use two concentrated (knife edge) loads per lane (LFD) or two trucks per lane (LRFD) in the load pattern generation (other rules in the referenced clauses relating to spacing and reduction factors are included, as appropriate also).

- Search Area to be used for reciprocal analysis** - The search area choice applies only to the assignments of reciprocal influences. Direct method influence assignments will automatically use the search area (if any) of the direct method influence analysis in which the influence attribute was assigned. Use of a search area will restrict the applied vehicle loading to a specified portion of the model. If a search area is not specified the generated vehicle loading will be projected onto the whole model ("Default"). For models where multiple intersections of the load projection occur it is necessary to restrict the loading to the required face using a search area.

Solution Process Options

- **View onerous effects table** Shows tabbed and sorted results for all chosen influences at nodes that are visible, with the most onerous result shown in the first row of the table. Displayed results can be filtered by subsequently selecting features or mesh objects of interest. For more information see [Onerous Effects Table](#) below.
- **Create loading patterns** To run a Vehicle Load Optimisation analysis with optimised loading select this check box, selecting either the **All chosen influences** option, which generates loads and loadcases for all chosen influences; or the **Most onerous** option, where for each influence attribute the loads and loadcases are only generated for the influence assignment that gives the most onerous effect. For both options, loading entries are created in the Attributes  treeview and an entry is created in the Analyses  Treeview under the corresponding VLO Run. To visualise the loading patterns a loadcase must be set active and appropriate [loading visualisation settings](#) made.
- The **Analysis** name provided creates an appropriate entry in the Analyses  Treeview. Note that an analysis can contain up to 1000 VLO Runs. Separate user-defined analysis entries can be created to hold different VLO Runs using the 'New' analysis option on the drop-down menu for the Analysis entry, but for speed of solving, note that it is more beneficial to have all VLO Runs contained within one analysis.
- The Vehicle Load Optimisation **Name** is used to identify each VLO Run. Short names are recommended since VLO Run names are used to create filenames that also include the influence name and coordinate and element details, and if collectively this is too long, the Windows path limit of 260 characters may be exceeded. See [File and folder naming in LUSAS](#) for details.

- When the **OK** button is pressed LUSAS will carry out the influence surfaces analysis and run a vehicle load optimisation analysis based on the country design code selected. The results from the analysis will be loaded into the LUSAS model in readiness for the model to be solved using the **Solve Now** button on the main toolbar.

When the model is solved for any selected onerous vehicle loading arrangements, the results from the analysis will be seen in the relevant Vehicle Load Optimisation  entry in the Analyses  Treeview.

Notes

- For models with numerous influence assignments of the same type, potentially un-necessary load generation can be avoided, and solution time can be saved, by ensuring that 'Create loading patterns' is not selected on the main VLO dialog, to allow for only the most onerous loading patterns to be created from the subsequent VLO onerous results table listings.
- The time taken to evaluate critical vehicle loading effects for a structure depends upon the design code in use; the types and numbers of vehicles to be considered; the number of lanes; whether any remaining areas exist after lane loading is positioned according to particular design codes; the number of spans; the mesh size; the values used for longitudinal and transverse load increments; whether one-way or two-way vehicle direction is specified; and the number of influence points to be evaluated. A good assessment of the time that will be required to evaluate a particular loading scheme for a large number of influence points can be achieved by initially timing how long it takes for just one influence point to be evaluated and factoring by the number of influences required.

Defaults Buttons

- **Defaults** buttons that are present on the main and many of the associated Vehicle Load Optimisation dialogs will reset selected parameters and values to their default settings.

Onerous Effects Table

When a VLO analysis is run, a VLO onerous effects table can be optionally displayed which shows sorted results for all chosen influences at nodes that are visible, with the most onerous result shown in the first row of the table. For Direct Method Influences these values are due to traffic loading for the specified load effect of interest at specified locations on the model. That is, a single value direct from the LUSAS Traffic Load Optimisation facility, without the need for a further static solution.

In the onerous effects table a results tab is present for each <Influence attribute – Sign – Design Case> group listed. This group is referred to as an 'Influence Design Loadcase'. Load patterns can be created on a case-by-case basis if not already created by means of the 'Create loading patterns' setting on the main VLO dialog.

	Influence Assignment	Node	Mx	Caused by	Create loading
1	Point 8 - (Surface 1)	127	224.859	HL93	Loading created
2	Point 8 - (Surface 2)	127	224.775	HL93	Create loading
3	Point 11 - (Surface 3)	113	224.15	HL93	Create loading
4	Point 11 - (Surface 2)	113	224.112	HL93	Create loading
5	Point 12 - (Surface 3)	10	206.304	HL93	Create loading
6	Point 12 - (Surface 2)	10	206.037	HL93	Create loading
7	Point 7 - (Surface 1)	23	205.848	HL93	Create loading
8	Point 7 - (Surface 2)	23	205.667	HL93	Create loading
9	(10.5074, 79.8113, 0.0) - (Element 57)	82	189.14	HL93	Create loading
10	(10.5074, 79.8113, 0.0) - (Element 77)	82	189.139	HL93	Create loading
11	(10.5074, 79.8113, 0.0) - (Element 75)	82	188.912	HL93	Create loading
12	(10.5074, 79.8113, 0.0) - (Element 60)	82	188.8	HL93	Create loading





On each results page, the following column headings are present:

- Influence Assignment** The location (coordinate and feature/object type) of the assigned DMI or Reciprocal Influence attribute.
- Node** The node at which the assignment was made. Note that the **Find** context menu option for the cells in this column will, when clicked, highlight the corresponding node in the model View window by animating concentric shrinking squares. This easily identifies the assignment location.
- 'Chosen results effect'** For Direct Method Influence, this column is named after the result entity component selected in the DMI attribute (e.g. Mx, Fz, etc); the values in this column show the effect of the traffic loads at locations of interest. For reciprocal influences, the column is named according to the influence type (i.e. Shear/Moment/Reaction/Displacement).
- Caused by** states the name of the loading type which produced the most onerous effect.
- Create loading** Creates loading entries in the Attributes Treeview and a loadcase in the Analyses Treeview that cause the onerous effect listed.

If the option to 'Create loading patterns' was chosen on the main VLO dialog, Loading folders will additionally appear for each influence loadcase added to the Analyses Treeview, and the VLO results table will show 'Loading created' alongside all influence assignment entries. If 'Create loading patterns' was not selected on the main VLO dialog the most onerous loading effects can be created individually by using the 'Create Loading' button that appears instead of the 'Loading Created' one.

For the influences where no loading is produced by LUSAS TLO (because for the specified location there aren't any loads that can be placed to produce an adverse effect), the 'Chosen results effect' and 'Caused by' cells will be empty.

Viewing, filtering and saving onerous effects tables

VLO onerous effects results tables can be re-displayed for all influences at any time by selecting the **View table results...** context menu for a  VLO Run entry in the Analyses  Treeview. A table for a single particular influence can be created by double-clicking on the relevant onerous results table  entry in the Analyses  Treeview.

Results displayed in the tables can be filtered by selecting features or mesh objects of interest in the view window. So, for instance, with table results displayed in one view window, it is possible to select a line representing a span in a bridge in the model view window and have the results table only display the results for the nodes in the elements within that line. Similarly it is possible to select a surface representing a span of a slab and view only the results for the nodes in the elements within that surface. Use the Window > Tile facilities to see the onerous results table data and model view window side-by-side. Column data can be sorted by clicking on column headers.

Table results for an active table can be saved to a spreadsheet using the **File > Save as Microsoft Excel** menu item.

Usage

Once the onerous effects for each 'Influence Design Loadcase' have been obtained, and if the option to 'Create loading patterns' was not chosen on the main VLO dialog, the corresponding loading will need to be created on a case-by-case basis, if not already done. Whilst generated loading patterns can be visualised, results are available only after the VLO analysis has been solved. Once solved, the resulting loadcases should be combined with self weight and factored accordingly to create design combinations.

Worked examples

- See Online help > Worked Examples > For LUSAS Bridge and LUSAS Civil & Structural > 'Bridge Slab Traffic Load Optimisation'.
- See Online help > Worked Examples > For LUSAS Bridge and LUSAS Civil & Structural > 'Grillage Load Optimisation'.
- See Online help > Worked Examples > For LUSAS Bridge and LUSAS Civil & Structural > 'Vehicle Load Optimisation of a Box Beam Bridge'.
- See Online help > Worked Examples > For LUSAS Bridge and LUSAS Civil & Structural > 'Add a User Vehicle to the Vehicle Load Optimisation Facility'.

Australia AS5100-2:2004 to 2017 Loading

This design code loading for these two editions is supported by one LUSAS Traffic Load Optimisation software option.

When using the country “Australia” and Design code “AS5100-2: 2004 to 2017” is selected on the main Vehicle Load Optimisation dialog, road traffic loading is generated with reference to: **AS5100-2: 2017** Australian Standard, Bridge design, Part 2: Design loads. The 2017 edition contains the same loading requirements as the 2004 edition with regard to vehicle load optimisation.

The scope of the vehicle load optimisation to AS5100-2:2004 to 2017 is restricted to vertical highway traffic loading and global effects. Horizontal components, railway loads and pedestrian loads are not currently included, although fatigue loading (AS5100-2 clause 6.9) is included.

Australia AS5100-2:2004 to 2017 Optional Settings

The Optional Code Settings dialog allows selection of the design values (ULS, SLS, Fatigue) and the load models (components from SM1600) required. Factors used in the calculations may be viewed and modified if required, by accessing the [Advanced](#) dialog.

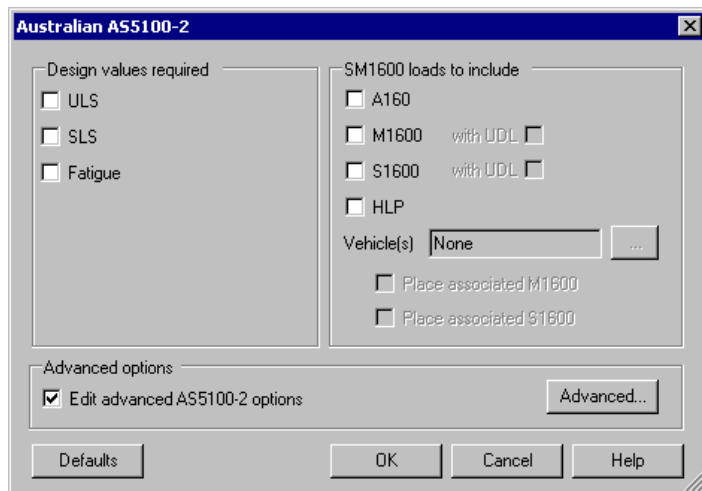

The following AS5100-2 options are available:

Design values required

The design values available on the dialog refer to AS5100-2 clauses 6.9 and 6.10 as follows:

- ❑ **ULS** Factors are taken from the “Ultimate” column of Table 6.10(A) in clause 6.10. Since Heavy Load Platform Load has a different factor from other traffic loads at the ultimate limit state, it is necessary for the factors in Table 6.10(A) to be considered as part of the optimisation process.
- ❑ **SLS** Factors are taken from the “Serviceability” column of Table 6.10(A) in clause 6.10. Since these factors are all unity, they do not affect the optimisation process unless adjusted using the Advanced dialog.
- ❑ **Fatigue** As described in clause 6.9, fatigue design verifications require the consideration of only A160 and M1600 truck loads, factored by 0.7. Accordingly S1600 and HLP loads will not be available if the Fatigue design case is the only case selected for analysis.

The dialog allows selection of one or more design values. The most onerous traffic loading pattern appropriate to each selected design value will be determined, with load factors included as appropriate.

Note

- In AS5100-2 clause 22, traffic loads are always considered together, as a “single block”, when combined with loads from other sources. If the ULS, SLS and Fatigue loadcases generated by the traffic load optimiser are combined with other loads, it should be noted that the load factors described above are already included within the optimised traffic loadcases.

SM1600 Loads to Include

According to the design values selected, some or all of the SM1600 load models are available to be included in the analysis. SM1600 load models are deemed mutually exclusive, that is, a traffic load pattern may comprise several A160 loads in various lanes, or several M1600 loads or several S1600 loads, but not a mixture of different load types. As indicated in the section above, S1600 and HLP loads are typically only available when ULS or SLS design values are requested.

- ❑ **A160 axle load** This is a single axle of 2m width positioned centrally within the 3.2m lane width as described in AS5100-2 clause 6.2.2. A dynamic factor applies when considering ULS, SLS or Fatigue (clauses 6.7.1 and 6.9). Consistent with other traffic loads, the wheel loads are treated as discrete point loads rather than being defined with a contact area.
- ❑ **M1600 moving traffic load** This is formed from a uniformly distributed lane load spread over the full width of the lane and placed in adverse areas, and a “M1600 truck” vehicle (four tri-axle groups with one variable axle spacing) which superimposes on the UDL as set out in AS5100-2 clause 6.2.3. The M1600 truck is used without UDL for Fatigue design verifications; additionally an option is provided to switch off UDL for all design values if required. A dynamic factor applies when considering ULS, SLS or Fatigue (clauses 6.7.1 and 6.9). An “M1600 tri-axle group” vehicle is also considered, identifying

when this vehicle is more onerous than the full M1600 moving load. A different dynamic factor applies for this configuration of the M1600. (see Table 6.7.2).

- ❑ **S1600 static traffic load** This is formed from a uniformly distributed lane load spread over the full width of lane and placed in adverse areas, and a “S1600 truck” vehicle (four tri-axle groups with one variable axle spacing) which superimposes on the UDL as set out in AS5100-2 clause 6.2.4. The dynamic allowance is zero, in line with Table 6.7.2, unless adjusted manually using the Advanced dialog. An option is provided to switch off UDL for all design values if required.
- ❑ **HLP (Heavy Load Platform)** Where specified by an authority a HLP320 or a HLP400 may be required, as per AS5100-2 clause 6.3. These vehicles always straddle two lanes and are placed near the centre of the lanes straddled; to account for errors in the positioning of actual vehicles, the most onerous location within 1.0m of the central position is identified. All other loads are excluded from the straddled lanes but M1600 or S1600, factored at 0.5, is placed in any unobstructed design lanes. See the note below on HLP lane restrictions where necessary. AS5100-7 clause A2.2.4 (vi) allows the central axle spacing to vary from the 1.8m standard, to a gap of between 6m and 15m, for continuous bridges. Within the traffic load optimiser this variable spacing has been conservatively included for single span bridges also. A dynamic factor applies when considering ULS, SLS or Fatigue (clauses 6.7.1 and 6.9); note that the dynamic factor for M1600 or S1600 in the unobstructed lanes has been interpreted by LUSAS to be the same as it would be without the HLP load present.
- ❑ **Vehicle(s)** Clicking the “...” button allows selection of one or more HLP vehicles. Where specified by an authority a HLP320 or a HLP400 may be required, as per AS5100-2 clause 6.3
- ❑ **Place associated M1600** This check box may be unchecked in order to obtain a result for HLP vehicles alone or HLP vehicles with S1600 only, however, the default is for associated M1600 to be included. In certain cases, it may be required to place associated M1600 loads in the absence of a selected HLP vehicle: see the note below on HLP lane restrictions.
- ❑ **Place associated S1600** This check box may be unchecked in order to obtain a result for HLP vehicles alone or HLP vehicles with M1600 only, however, the default is for associated S1600 to be included. In certain cases, it may be required to place associated S1600 loads in the absence of a selected HLP vehicle: see the note below on HLP lane restrictions.

The road carriageway is divided into standard design lanes (3.2m wide) according to AS5100-2 clause 6.5. This will result in a “remaining width” for any carriageways of width not an integer multiple of 3.2m. The lanes are positioned laterally on the bridge to produce the most adverse effects, with the remaining width being placed either side of the lanes or between any of the lanes so as to produce the most onerous arrangement.

Lane factors for A160, M1600 and S1600 load models are according to Table 6.6 or as set in the Advanced dialog, and are allocated so as to produce the most adverse load effect. Where HLP loading is applied according to AS5100-2 clause 6.3, lane factors do not seem to be applicable to the straddling HLP vehicle or to the accompanying M1600 or S1600, which is factored at 0.5. On this understanding, and with reference to AS5100-7 clause A2.2.6, lane factors are not used with HLP loading.

HLP lane restrictions

HLP vehicles in specific lanes. AS5100-2 clause 6.3 indicates that the two lanes which the HLP vehicle straddles may be specified by the authority. By default, the HLP will be placed in the most adverse position, using any possible lane arrangements as determined using clause 6.5. While not a strict implementation of clause 6.3, this is conservative and eliminates the need to identify the HLP lanes.

If it is required to restrict the placement of HLP to two specific lanes, two runs of the traffic load optimiser can be used. The first run would consider a notional carriageway only two lanes wide positioned as required for placement of the HLP vehicle only. The second run would use one or more carriageways for placement of the “accompanying” M1600 or S1600 only. Superposition of the results from the two runs using **combinations** will obtain the combined effects of the HLP and accompanying traffic loads.

Load models excluded from this dialog

The W80 load of AS5100-2 clause 6.2.1 is a single heavy wheel applied anywhere on the carriageway. It is for local verifications only and therefore is deemed outside the remit of the traffic load optimiser, which is intended for the generation of traffic load patterns applicable to global bridge deck analyses.

Advanced options

- Edit advanced AS5100-2 options** - See [Australia AS5100-2 Advanced Settings](#)

Australia AS5100-2 Advanced Settings

This dialog is used to view and modify dynamic factors, lane factors, load factors, the HLP reduction factors and to request additional output.

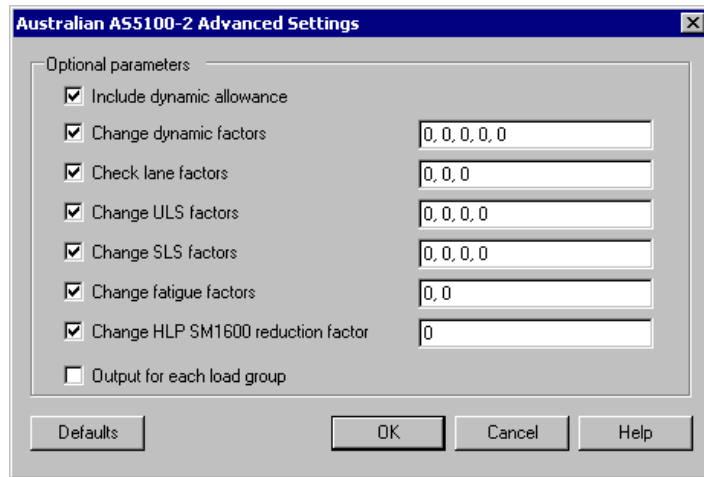

Using the checkboxes factors may be entered manually to suit project requirements.

- Include dynamic allowance** (Selected by default) Dynamic load allowances are required to be included for ULS, SLS and Fatigue design verifications according to AS5100-2 clause 6.7. These are incorporated by default but may be excluded by unticking this check box.
- Change dynamic factors** Dynamic factors are listed for each load model in turn: A160, M1600 (triale group), M1600, S1600, HLP. Default values are derived from AS5100-2 Table 6.7.2 by adding unity to the “allowance” in the table.
- Check lane factors** Lane factors are listed in descending lane rank: ALF_1 , ALF_2 , ALF_3 where the subscript numbers correspond to the numbering in the notes under AS5100-2 Table 6.6. ALF_3 is used for the third lane and all subsequent lanes. Default values are from Table 6.6.
- Change ULS factors** ULS factors are listed for each load model in turn: A160, M1600, S1600, HLP. Default values are from AS5100-2 Table 6.10(A), “ultimate” column.
- Change SLS factors** SLS factors are listed for each load model in turn: A160, M1600, S1600, HLP. Default values are from AS5100-2 Table 6.10(A), “serviceability” column.
- Change fatigue factors** Fatigue factors are listed for each applicable load model in turn: A160, M1600. Default values are from AS5100-2 clause 6.9.
- Change HLP SM1600 reduction factor** This factor is used to reduce accompanying M1600 and accompanying S1600 loads according to AS5100-2 clause 6.3. The default value, as per that clause, is 0.5.
- Defaults** This button resets all values back to the default according to AS5100-2.

Australia AS5100-7:2004 (Austroads) Loading

This design code loading is supported by the LUSAS Traffic Load Optimisation software option.

When using the country “Australia” and Design code “AS5100-7:2004 (Austroads)” is selected on the main Vehicle Load Optimisation dialog, road traffic loading is generated with reference to Australian Standard **AS5100.7-2004**, Bridge design, Part 7: Rating of existing bridges, Clause A2.2.

The 1992 Austroads Bridge Design Code is a former design code which is now used for assessment, and is reproduced in AS5100-7 Appendix A Clause A2.2. The loading consists of either L44 loading (a UDL with a concentrated load, or with two concentrated loads on continuous spans) or T44 loading (a Truck load). A heavy vehicle (HLP 320 or HLP400) can replace two lanes of standard loading, with a variable axle spacing for continuous spans.

The road carriageway is divided into standard design lanes (3m wide) according to AS5100-7 clause A2.2.5.1(a), the number of lanes being dependant on the carriageway width divided by 3.1m. Where more than one lane is loaded, multiple lane modification factors to clause A2.2.6 are applied to L44 and T44 loads. Loads are increased by dynamic load allowances to clause A2.2.10, and load factors are applied to all loads as per clause A2.2.9.

Note that the scope of the vehicle load optimisation to AS5100.7 is similar to other implemented codes of practice, that is, restricted to vertical highway traffic loading and global effects. Horizontal components, railway loads and pedestrian loads are not currently included.

Optional code settings dialog

The Optional Code Settings dialog allows selection of the design values (ULS, SLS, Fatigue) and the load models required. Factors used in the calculations may be viewed and modified if required, by accessing the Advanced dialog.

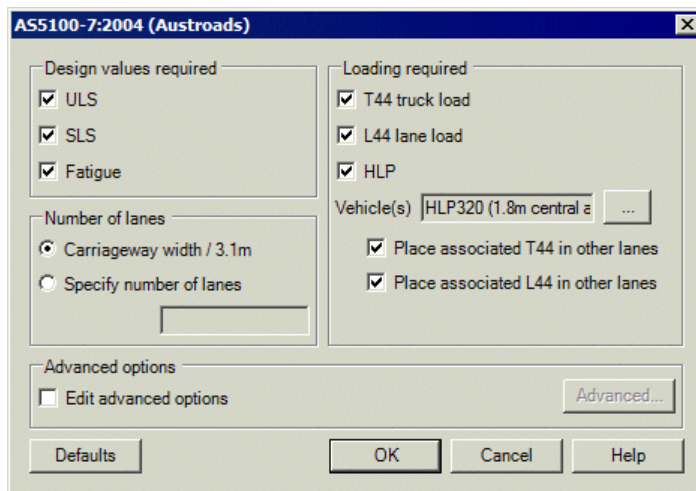

Design values required

The design values available on the dialog refer to AS5100-7 clauses A2.2.8 and A2.2.9 as follows:

- ULS** Factors are taken from the Table A4 in clause A2.2.9. Since Heavy Load Platform Load has a different factor from other traffic loads at the ultimate limit state, it is necessary for the factors in Table A4 to be considered as part of the optimisation process.
- SLS** Factors are taken from clause A2.2.9. Since these factors are all unity, they do not affect the optimisation process unless adjusted using the Advanced dialog.
- Fatigue** As described in clause A2.2.8, fatigue design loads considered are T44 truck and L44 lane load. Accordingly HLP loads will not be available if the Fatigue design case is the only case selected for analysis. No load factors are specified in clauses A2.2.8 or A2.2.9 so unity is used; this may be adjusted using the Advanced dialog.

The dialog allows selection of one or more design values. The most onerous traffic loading pattern appropriate to each selected design value will be determined, with load factors included as appropriate.

Loading required

According to the design values selected, some or all of the load models are available to be included in the analysis. As indicated in the section above, HLP loads are only available when ULS or SLS design values are requested.

- T44 truck load** This is a five-axled vehicle with a variable spacing between the rear two tandem axle groups, as set out in AS5100-7 Figure A1.

- L44 lane load** This is formed from a uniformly distributed lane load spread over the 3m lane width and placed in adverse areas, and a concentrated load, also spread over the 3m lane width, which superimposes on the UDL as set out in AS5100-7 clause A2.2.3. The UDL intensity is suitable up to 150m loaded length, as per Figure A2; values for longer loaded lengths can be entered via the Advanced dialog.
- HLP (Heavy Load Platform)** Where specified by the authority a HLP320 or HLP400 may be required, as per AS5100-7 clause A2.2.4. These vehicles always straddle two lanes and are placed near the centre of the lanes straddled; to account for errors in the positioning of actual vehicles, the most onerous location within 1.0m of the central position is identified. All other loads are excluded from the straddled lanes but T44 or L44, factored at 0.5, is placed in any unobstructed design lanes. See the note below on HLP lane restrictions where necessary.
- Vehicle(s)** Clicking the “...” button allows selection of one or more HLP vehicles. HLP320 and HLP400 vehicles are described in AS5100-7 clause A2.2.4, formed of 16 axles in two groups of 8 axles and are of 3.6m and 4.5m overall width respectively.
- Place associated T44 in other lanes / Place associated L44 in other lanes** These checkboxes control which loads are considered in lanes which are not obstructed by HLP loads.

The road carriageway is by default divided into standard design lanes (3m wide) according to AS5100-7 clause A2.2.5.1(a), the number of lanes being dependant on the carriageway width divided by 3.1m. This will result in a “remaining width” which is unloaded. The lanes are positioned laterally on the bridge to produce the most adverse effects, with the remaining width being placed either side of the lanes or between any of the lanes so as to produce the most onerous arrangement.

An alternative lane strategy to clause A2.2.5.1(b) can be achieved using the “Specify number of lanes” option. If this option is used to specify a single lane then that lane is positioned laterally at any location within the carriageway, for most onerous effect. If more than one lane is specified, the carriageway is divided evenly into that many lanes, with the 3m wide loading positioned up to 500mm from the centre of these lanes, so as to produce the most onerous effect.

Multiple lane modification factors for T44 and L44 load models are according to Table A2 or as set in the Advanced dialog, and are allocated so as to produce the most adverse load effect. Where HLP loading is applied to clause A2.2.5.2, the factor for associated loads of 0.5 is used instead of the multiple lane factors.

A dynamic load allowance applies when considering ULS, SLS or Fatigue (clause A2.2.10.2); this can be edited via the Advanced dialog.

HLP lane restrictions

HLP vehicles in specific lanes. AS5100-7 clause A2.2.5.2 indicates that the two lanes which the HLP vehicle straddles may be specified by the authority. By default, the HLP will be placed in the most adverse position, using any possible lane arrangement. While not a strict implementation of clause A2.2.5.2, this is conservative and eliminates the need to identify the HLP lanes altogether.

If it is required to restrict the placement of HLP to two specific lanes, two runs of the traffic load optimiser can be used. The first run would consider a notional carriageway only two lanes wide positioned as required for placement of the HLP vehicle only. The second run would use one or more carriageways for placement of the “accompanying” T44 or L44 only, with multiple lane modification factors revised to reflect the accompanying factor instead. Superposition of the results from the two runs may be used to obtain the combined effects of the HLP and accompanying traffic loads.

Load models excluded from this dialog

The W7 wheel load of AS5100-7 clause A2.2.7 is a single heavy wheel applied anywhere on the carriageway. It is for local verifications only and therefore is deemed outside the remit of the traffic load optimiser which is intended for the generation of traffic load patterns applicable to global bridge deck analyses.

Australia AS5100-7:2004 (Austroads) Advanced Settings

This dialog is used to view and modify multiple lane modification factors, a factor for HLP associated loads, dynamic factors, global factors and a number of additional settings.

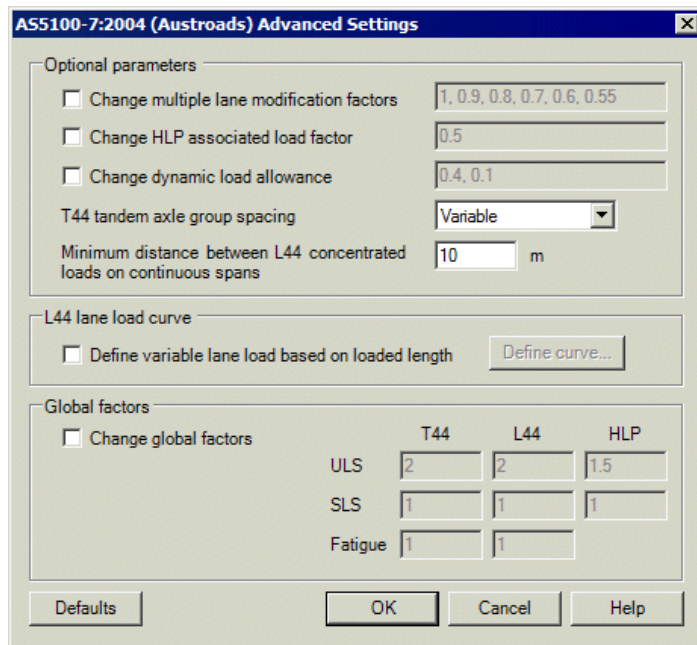

Optional parameters

- Change multiple lane modification factors** This option allows the modification factors for multiple lane bridges, from AS5100-7 clause A2.2.6, to be edited. The textbox has a comma separated list of six variables, applicable respectively to: one lane loaded, two lanes loaded, three lanes loaded, four lanes loaded, five lanes loaded, six or more lanes loaded.
- Change HLP associated load factor** AS5100-7 Clause A2.2.5.2 requires T44 or L44 loads which accompany HLP loads to be half (i.e. 0.5) of their normal value. This option allows the modification of this factor. Note: this factor is considered to replace the multiple lane modification factors when HLP loading is present
- Change dynamic load allowance** This option allows the modification of the dynamic load allowance from AS5100-7 Clause A2.2.10. The textbox has a comma separated list of two variables, applicable respectively to HLP loads and T44/L44 loads. Note the maximum value from Figure A4, i.e. 0.4, has conservatively been implemented as the default for T44/L44 loads.
- T44 tandem axle group spacing** The T44 Truck from AS5100-7 Figure A1 has an axle spacing which varies from 3m to 8m; this is implemented by default. This option gives the opportunity to restrict which axle spacings are considered in order to give a faster optimisation process. Axle spacing options should only be restricted when engineering judgement deems this will give a sufficiently accurate result.

- ❑ **Minimum distance between L44 concentrated loads on continuous spans**
AS5100-7 Clause A2.2.3 allows two concentrated loads which must be in separate spans. This is currently implemented by requiring a minimum distance between the two loads. The required minimum distance to keep them in separate spans, while not forcing them so far apart that they cannot be placed at the local peak adverse influence ordinates, varies depending on span lengths and their ratios to each other. If the defined minimum spacing is too small for a given bridge, Vehicle Load Optimisation may place both loads in the same span. This is incorrect but conservative. If the defined minimum spacing is too large for a given bridge, VLO will not be able to place both loads on the peak influences of their spans. This is incorrect and unconservative. For typical span ratios, a value of 2/3 of the maximum span is usually appropriate.

L44 Lane load curve

- ❑ **Define variable lane load based upon loaded length** AS5100-7 Figure A2 defines the intensity of the UDL up to and including a loaded length of 150m. This intensity can be modified, or values for longer loaded lengths defined, using this option.

Global factors

- ❑ **Change global factors** The default values provided to AS5100-7 Table A4 may optionally be edited. Note no load factors are specified in clauses A2.2.8 or A2.2.9 for Fatigue, so unity is used.

Defaults button is provided to reset all values back to those specified in AS5100-7.

Australia AS5100-7:2004 (Austroads) - Curve definition

The curve definition dialog allows the definition of a piecewise linear curve. The Traffic Load Optimiser carries out straight line interpolation between the entered values. For more accurate interpolation as many points as possible should be specified.

Canada CAN/CSA-S6-06 (Design) Optional Code Settings

This design code loading is supported by the LUSAS Traffic Load Optimisation software option.

When the country 'Canada' and Design code 'CAN/CSA-S6-06 (Design)', is selected on the main Vehicle Load Optimisation dialog, road traffic loading is generated with reference to CAN/CSA-S6-06 Section 3.

Scope

The scope of the vehicle load optimisation to CAN/CSA-S6-06 is restricted to vertical highway traffic loading and global effects. Horizontal components, railway loads and pedestrian loads are not currently included.

The road carriageway is divided into a number of equal width lanes as per CAN/CSA-S6-06 Table 3.4, which includes a check for the most onerous of 2 or 3 lanes for carriageway widths between 10.0m and 13.5m.

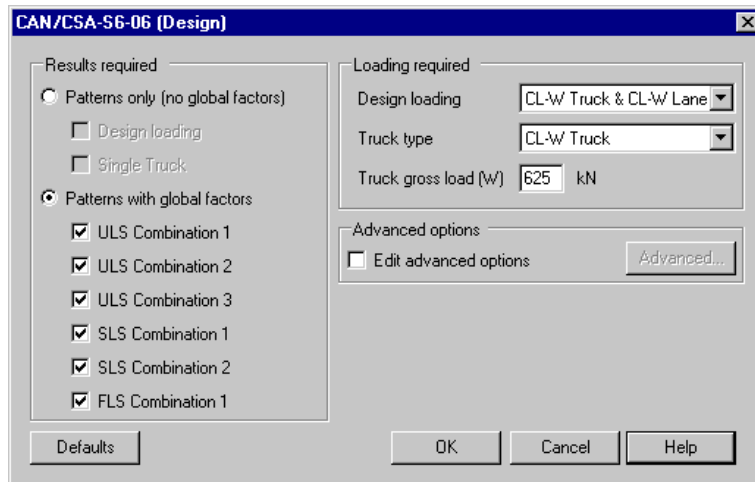

The Optional Code Settings dialog allows selection of the combinations and loads required. Factors used in the calculations may be viewed and modified if required, by accessing the Advanced Settings dialog.

Results required

Loading patterns are available either globally factored (i.e. with a Load Factor for a Limit State to CAN/CSA-S6-06 Table 3.1, or optionally edited in the Advanced Settings dialog) or unfactored as follows:

Patterns only (no global factors)

- **Design loading** - Loading to clause 3.8.4.1 (d) - truck load increased by the dynamic load allowance or the lane load, whichever produces the maximum load effect
- **Single Truck** - Loading to clause 3.8.4.1 (c) - one truck only, placed at the centre of one travelled lane

Patterns with global factors

- ULS Combination 1 / ULS Combination 2 / ULS Combination 3 / SLS Combination 1 - as per Design loading pattern but with the relevant global factor from CAN/CSA-S6-06 Table 3.1
- SLS Combination 2 / FLS Combination - as per Single Truck pattern but with the relevant global factor from CAN/CSA-S6-06 Table 3.1

The dialog allows selection of one or more combinations. The most onerous traffic loading pattern appropriate to each selected combination will be determined, with load factors included as appropriate.

Loading required

- Design loading** - CL-W loads to include. For combinations other than Single Truck patterns, this gives the option to consider only Truck loading, only Lane loading, or both. If both are selected, the most onerous is output for each influence/combination - as per commentary on CAN/CSA-S6-06, clause C3.8.4.2, "Simultaneous loading of different design lanes by truck and lane load need not be considered."
- Truck type**. This option allows the selection of the CL-W distribution (to CAN/CSA-S6-06 clause 3.8.3.2), a CL-W-ONT distribution (derived from the CL-625-ONT distribution to CAN/CSA-S6-06 Annex A3.4) or a BCL-W distribution (derived from the BCL-625 distribution to British Columbia Ministry of Transportation and Infrastructure - Bridge Standards and Procedures Manual Volume 1 Figure 3.2a).
- Truck gross load (W)**. This setting allows the gross load of the selected Truck to be entered.

Modification factors for multi-lane loading are applied as per CAN/CSA-S6-06 Table 3.5, or optionally edited via the [Advanced Settings](#) dialog. The optimisation process takes account of these factors when calculating the most onerous load effect, such that every lane may not be loaded.

The dynamic load allowance to CAN/CSA-S6-06 clause 3.8.4.5.1 (or optionally edited via the Advanced Settings dialog) is applied to all Trucks, except for Single Truck loading to clause 3.8.4.1 (c) or when it forms part of lane loading to clause 3.8.3.3. The optimisation process takes account of the dynamic load allowance when calculating the most onerous load effect, such that axles may not be used even when they are adverse.

A **Defaults** button is provided to reset all values back to those specified in CAN/CSA-S6-06.

CAN/CSA-S6-06 (Design) Optional Code Settings (Advanced)

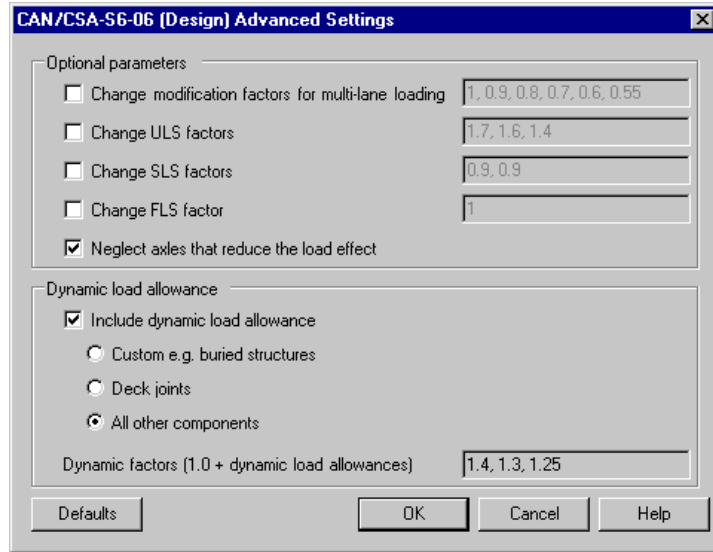

This dialog is used to view and modify modification factors for multi-lane loading, global factors and dynamic factors.

Optional parameters

- Change modification factors for multi-lane loading** This option allows the modification of the factors from the values in CAN/CSA-S6-06 Table 3.5, which are implemented as default values. The textbox has a comma separated list of six variables, applicable respectively to: one lane loaded, two lanes loaded, three lanes loaded, four lanes loaded, five lanes loaded, six or more lanes loaded.
- Change ULS factors** The default values provided to CAN/CSA-S6-06 Table 3.1 may optionally be edited. The textbox has a comma separated list of three variables, applicable respectively to: ULS Combination 1, ULS Combination 2, ULS Combination 3.
- Change SLS factors** The default values provided to CAN/CSA-S6-06 Table 3.1 may optionally be edited. The textbox has a comma separated list of two variables, applicable respectively to: SLS Combination 1, SLS Combination 2.
- Change FLS factor** The default value provided to CAN/CSA-S6-06 Table 3.1 may optionally be edited.
- Neglect axes that reduce the load effect** As per CAN/CSA-S6-06 clause 3.8.4.1(a) Truck axes which reduce the load effect are neglected. If this option is deselected then all axes will be included, whether they are adverse or

relieving, or even adverse but reducing the load effect(due to dynamic factoring).

Dynamic load allowance

- Include dynamic load allowance** if deselected, cause the dynamic factors to all be set to 1.0.
- Custom e.g. buried structures** if selected, causes the textbox to be user-editable.
- Deck joints** if selected, sets the dynamic factor to 1.5 for one axle and 0.0 for more axles, as per CAN/CSA-S6-06 clause 3.8.4.5.3(a).
- All other components** if selected,sets the dynamic factors as per CAN/CSA-S6-06 clause 3.8.4.5.3(b) to (d).
- Dynamic factors** (implemented as 1.0 + dynamic load allowances) are displayed in the textbox and may be optionally edited. The textbox has a comma separated list of three variables, applicable respectively to: one axle used, two axles (or axles nos. 1 to 3) used, three axles (other than axles nos. 1 to 3) or more used.

Notes

- CAN/CSA-S6-06 clause 3.8.4.1 specifically includes Dynamic Load Allowance for SLS1 and ULS1-3 while not mentioning it for FLS and SLS2. It is therefore interpreted that dynamic load allowance does also apply for FLS or SLS2, due to clause 3.8.4.5.1 stating it shall be applied "unless otherwise specified elsewhere in this code".

Default values

- The **Defaults** button is provided to reset all values back to those specified in CAN/CSA-S6-06.

China JTG D60-2015 Optional Code Settings

This design code loading is supported by the LUSAS Traffic Load Optimisation software option.

When the country 'China' and Design code 'JTG D60-2015', is selected on the main Vehicle Load Optimisation dialog, road traffic loading is generated with reference to JTG D60-2015 General Code for Design of Highways Bridges and Culverts, Chapter 4: Actions.

Scope

The scope of the vehicle load optimisation to JTG D60-2015 is restricted to vertical highway traffic loading and global effects. Accidental actions, horizontal components and pedestrian loads are not currently included.

Optional code settings dialog

The Optional Code Settings dialog allows selection of the design values (Vehicle load level and Characteristic, Frequent and Quasi-permanent values), the maximum number of lanes to be loaded, the loads to include (Lane loading and/or Vehicular loading) and the Impact factor. Other factors used in the calculations and further options may be viewed and modified if required, by accessing the Advanced dialog.

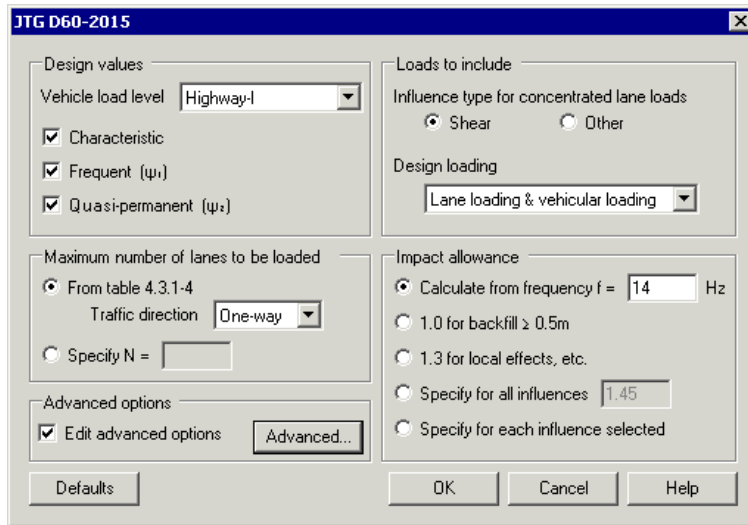

Design values required

- **Vehicle load level** is used to specify the factors to be applied. Options are “Highway-I”, “Highway-II” and “Highway-II Grade 4”.

Factors applied are as follows:

Type of Highway Lane loads (qk and Pk) Vehicular load	Lane loads (qk and Pk)	Vehicular load
Highway-I	1.00	1.00
Highway-II	0.75	1.00
Highway-II Grade 4	0.60	0.70

The checkboxes “Characteristic”, “Frequent (ψ_1)” and “Quasi-permanent (ψ_2)” are used to specify which combinations are required for the optimisation.

The factors applied to all loads in each of the combinations are as shown in the table below:

Combination

Characteristic	1.00
Frequent	0.70 (can be modified in advanced options)
Quasi-permanent	0.40 (can be modified in advanced options)

Loads to include

- Influence type for concentrated lane loads** As per JTG D60-2015 section 4.3.1-4(1), for calculation of shear effect, the characteristic value of concentrated load in lane load Pk shall be multiplied by factor 1.2. Therefore, when shear influences are chosen in the optimisation, the option “Shear” must be selected. When influences different from “Shear” are chosen in the optimisation, the option “Other” must be selected.
- Design loading**
 - **Lane loading & vehicular loading:** On each loaded lane, the most onerous of lane loading or vehicular loading will be placed
 - **Lane loading only:** Only lane loading will be placed on all loaded lanes
 - **Vehicular loading only:** Only vehicular loading will be placed on all loaded lanes

Maximum number of lanes to be loaded

The carriageway is divided in notional lanes 3.1 metres wide. For carriageways that are of a width that is not an integer multiple of 3.1 metres there may be a remaining width. Note also that not all notional lanes are always loaded.

The maximum number of lanes to be loaded is summarized in the table shown below, where W=Carriageway width, and Int=Integer part of. This table has been interpreted from JTG D60-2015 table 4.3.1-4.

Carriageway width W (m)	One way traffic	Two-way traffic
$W < 6.0$	1	Not applicable
$6.0 \leq W < 7.0$	1	2
$7.0 \leq W < 35.0$	$Int\left(\frac{W}{3.5}\right)$	$2 \times Int\left(\frac{W}{7.0}\right)$

- Traffic direction** specifies whether the traffic in the bridge is one way or two way.

Note: This only controls the maximum number of lanes to be loaded. The directions of the vehicles in the bridge will always be the most critical ones, regardless of the option selected here. For example, when selecting “Two-way” traffic in a bridge with two

lanes, both vehicles could be positioned in the same direction. This will happen if this situation is more onerous than positioning the vehicles in opposite directions.

- Specify N=** Entering a integer specifies the maximum number of lanes to be loaded.

Loads to include

- Influence type for concentrated lane loads** As per JTG D60-2015 section 4.3.1-4(1), for calculation of shear effect, the characteristic value of concentrated load in lane load P_k shall be multiplied by factor 1.2. Therefore, when shear influences are chosen in the optimisation, the option “Shear” must be selected. When influences different from “Shear” are chosen in the optimisation, the option “Other” must be selected.
- Design loading**
 - **Lane loading & vehicular loading** On each loaded lane, the most onerous of lane loading or vehicular loading will be placed
 - **Lane loading only** Only lane loading will be placed on all loaded lanes
 - **Vehicular loading only** Only vehicular loading will be placed on all loaded lanes

Impact allowance

These radio buttons can be set to define the impact allowance.

- Calculate from frequency f** = The natural frequency of the structure (in Hertz) must be introduced, and the impact factor applied to vehicular loads will be calculated according to the following table, as per JTG D60-2015 section 4.3.2(5)

Condition	Impact factor ($1+\mu$)
$f < 1.5\text{Hz}$	1.05
$1.5 \leq f \leq 14\text{Hz}$	$0.1767 \ln f + 0.9843$
$f > 14\text{Hz}$	1.45

- 1.0 for backfill $\geq 0.5\text{m}$** as per JTG D60-2015 section 4.3.2(2)
- 1.3 for local effects, etc** as per JTG D60-2015 section 4.3.2(6)
- Specify for all influences** the impact factor must be introduced
- Specify for each influence selected** this option must be selected if different impact factors are needed for different influences within the same Vehicle Load Optimisation run. In this case there will be an extra column in the influence dialog to introduce a factor for each influence.

China JTG D60-2015 Optional Code Settings (Advanced)

Optional parameters

The length (L_0) used to calculate the concentrated lane load P_k , as per JTG D60-2015 table 4.3.1-2, and the longitudinal reduction coefficient, as per JTG D60-2015 table 4.3.1-6 needs to be specified. This can be done by stating:

- Length of kerblines** the length of the carriageway, defined by two kerblines, will be used as Length L_0 . In the case of a bridge with multiple carriageways, the average of all carriageway lengths will be considered.
- Specify** if length of kerblines is not used, a value for the length must be specified.

Change ψ factors

- Frequent** and **Quasi-permanent** ψ factors used in these combinations can be edited. The default values are from JTG D60-2015 sections 4.1.7(1) and 4.1.7(2)
- Change transversal reduction coefficients** This option allows the modification of these coefficients from the values in JTG D60-2015 table 4.3.1-5, which are implemented as default values. The textbox has a comma separated list of eight values, applicable respectively to: one lane loaded, two lanes loaded, three lanes loaded, four lanes loaded, five lanes loaded, six lanes loaded, seven lanes loaded, eight or more lanes loaded:

<u>Number of Loaded Lanes</u>	<u>Default TRC</u>
1	1.20
2	1.00
3	0.78
4	0.67
5	0.60
6	0.55
7	0.52
8 or more	0.50

- Change longitudinal reduction coefficients** This option allows the modification of these coefficients from the values in JTG D60-2015 table 4.3.1-6, which are implemented as default values. The textbox has a comma separated list of four values, corresponding to each of the lengths L_0 shown in the table below:

<u>Total length L_0 (m)</u>	<u>Default LRC</u>
$L_0 \leq 150$	1.00
$150 < L_0 < 400$	0.97
$400 \leq L_0 < 600$	0.96
$600 \leq L_0 < 800$	0.95
$800 \leq L_0 < 1000$	0.94
$L_0 \geq 1000$	0.93

- Exclude relieving axles** When this option is ticked, the relieving axles of the vehicular loading will be excluded. When it is un-ticked, all axles will be considered regardless they have an adverse or relieving effect.

Eurocode Traffic Loading

Traffic loading on bridges to the Eurocodes is specified in two main documents:

- EN1991-2:2003 Eurocode 1: Actions on structures – Part 2: Traffic loads on bridges
- EN1990:2002 +A1:2005 Eurocode: Basis of Structural design

However, the Eurocodes allow a choice of safety related parameters and of certain country-specific data, known collectively as Nationally Determined Parameters (NDPs), which are published in National Annexes that accompany each Eurocode part.

National Annexes supported

Selecting one of the available National Annexes on the main Vehicle Load Optimisation dialog sets default values for NDPs (α_0 , α_s , ψ) and offers traffic load options (e.g. traffic classes, Load Model 3 special vehicles and complementary load models) appropriate to that National Annex. Values may, in any case, be modified to meet specific requirements through the options on the various dialogs.

The following National Annexes are currently supported by LUSAS Traffic Load Optimisation software by first picking the Europe country option:

- Denmark**
- Ireland**
- Italy**
- Poland**
- Recommended Values**
- Sweden**
- UK**

The Recommended Values option sets defaults and offers traffic options based only on recommendations in the main Eurocode documents. This option, with or without modification of values, may be of particular use for countries where a National Annex is not yet published or not yet supported.

Notes

- The scope of the vehicle load optimisation to Eurocodes is the same as for previously implemented codes of practice, that is, restricted to vertical highway traffic loading and global effects. Railway loads and fatigue loading are not currently included.

EN1991-2 Optional Code Settings

This design code loading is supported by the LUSAS Traffic Load Optimisation software option.

This is a representative dialog for all countries supported. The options available on the dialog depend upon the design code and National Annex supported.

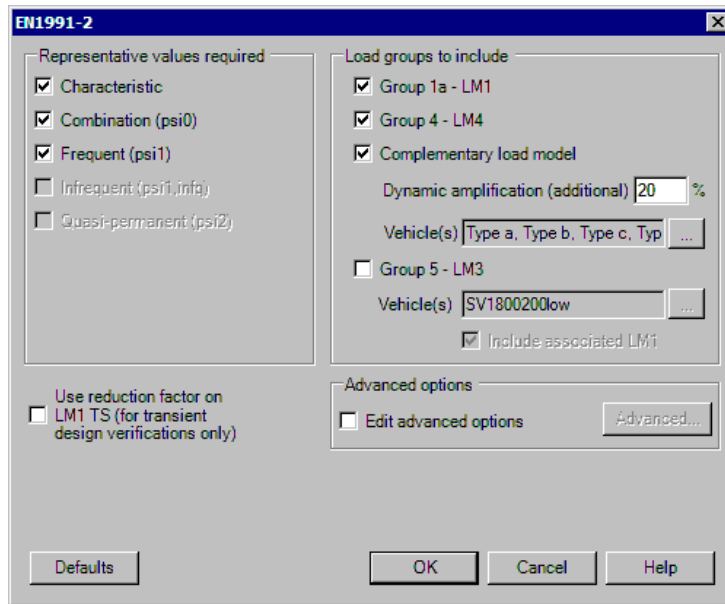

The Optional Code Settings dialog allows defining of the Representative Values that are required and Load Groups that are to be included. Factors used in the calculations may be viewed and modified by accessing the [Advanced Settings](#) dialog.

Representative values required

The various levels of Representative Values in the Eurocodes are represented on this dialog as follows:

- ❑ **Characteristic values** See EN1990:2002 clause 1.5.3.14. Characteristic traffic actions are defined by Table 4.4a in EN1991-2:2003. This includes Group 1a (LM1 with no ψ value used) and Group 5 (generally LM3 with no ψ value together with LM1 with ψ_1 – but depends on National Annex). Characteristic values are used in for the leading variable action ($Q_{k,i}$) in ULS design checks (EN1990 equation 6.9a) and Irreversible SLS checks (equation 6.14a).
- ❑ **Combination values** Combination traffic actions are defined by use of ψ_0 from EN1990 table A2.1 (See EN1990 clause 1.5.3.16). It should be noted that ψ_0 for Group 5 is zero, therefore the Optional Code Settings dialog identifies Group 1a (LM1) loading alone as appropriate for the Combination case. Combination values are used for the accompanying variable action ($Q_{k,i}$) in ULS design checks (EN1990 equation 6.9a) and Irreversible SLS checks (equation 6.14a).
- ❑ **Frequent values** Frequent traffic actions are defined by Table 4.4b in EN1991-2 or by use of ψ_1 from EN1990 table A2.1 (See EN1990 clause 1.5.3.17) – these two sources are in harmony. It should be noted that ψ_1 for Group 5 is zero, therefore the Optional Code Settings dialog identifies Group 1a (LM1)

loading alone as appropriate for the Frequent case. Frequent values are used for the leading variable action ($Q_{k,1}$) in reversible SLS checks (equation 6.15a).

- ❑ **Infrequent values** Infrequent traffic actions are defined by use of $\psi_{1,infq}$ from EN1990 table A2.1 Note 2; which includes Group 1a (LM1) and Group 4 (LM4).
- ❑ **Quasi-permanent values** (when applicable) Defined by use of ψ_2 from EN1990 Table A2.1 (See EN1990 clause 1.5.3.18).

The dialog allows selection of the Representative Values for which the most onerous effect will be calculated.

Notes

- EN1991-2 does not refer to Combination values specifically; presumably the assumption is that traffic will never be an accompanying action but always a leading action. However the combination values are defined adequately using EN1990 Table A2.1 ψ_0 values and are therefore available should they be required.

Load Groups to include

According to the Representative Values selected, one or more Load groups are available to be included in the analysis. As indicated in the section above, Group 5 loads are typically only available when the Characteristic Values are being sought. The dialog includes only the Load Groups from EN1991-2 Table 4.4a and 4.4b that are relevant:

- ❑ **Group 1** comprises Load Model 1 (LM1) tandem system and uniformly distributed loads with the appropriate α , ψ and transient factors where appropriate. Note that for global analysis the tandem system is placed on the centreline of the lane (EN1991-2 clause 4.3.2(1)(a)), however the simplified rules in 4.3.2(6) are not used. Complete tandem systems are used (EN1991-2 clause 4.3.2(1)(a)) and the most onerous length of lane for application of the uniformly distributed load is determined for each lane in turn by integration of the influence surface across the lane width. Footway, cycle track and horizontal loads are excluded from the scope of the optimisation facility.
- ❑ **Group 4** comprises Load Model 4, which represents Crowd loading - see EN1991-2 clause 4.3.5. Crowd loading is applied in the carriageway area; footway and cycle track loads are excluded from the scope of the optimisation facility.
- ❑ **Complementary load model** Options associated with complementary load models will be available where such a load model is specified in the selected National Annex, according to the Representative Values for which that load model applies.
- ❑ **Group 5** is relevant only for Characteristic Values and comprises LM3 (special vehicles) combined with LM1 reduced according to rules given in the National

Annex, or – in the case of the Recommended Values option – rules given in the informative Annex A to EN1991-2.

- Vehicle(s)** Clicking the  button allows selection of one or more special vehicles as defined in the selected National Annex.
- Include associated LM1** This check box may be unchecked in order to obtain a result for LM3 special vehicles alone, however, the default is for LM1 to be included.

For all load groups, the lane division is according to EN1991-2 Table 4.1, with the remaining area (EN1991-2 clause 4.2.5(2)) being placed either side of the lanes or between any of the lanes in the carriageway area to produce the most onerous arrangement. Likewise, lane ranking is so as to produce the most onerous effect for the influence under consideration (as EN1991-2 clause 4.2.4(2)).

Reduction factor for transient design verifications

EN1991-2 clause 4.5.3(2) may be invoked with this check box if required.

Traffic Class for LM1

As per EN1991-2 clause 4.3.2 (3) note 2, some National Annexes require a traffic class to be specified for the selection of α_Q and α_q factors. Where this is the case, the “Traffic Class” box appears on this dialog: for National Annexes where no traffic classes are specific, and for the Recommended Values option, the “Traffic Class” box does not appear on the dialog. See the notes for the relevant National Annex for more information.

Load Groups excluded from appearing on this dialog

- Group 1b** comprises only Load Model 2 which is for local verifications (“short structural members” to EN1991-2 clause 4.3.1(2)(b)) and so is excluded from the scope of the traffic load optimiser and does not appear on this dialog.
- Group 2** is relevant only for the Characteristic Values and comprises LM1 (with smaller ψ factors compared to Group 1a) together with horizontal forces. Since horizontal forces are excluded from the scope of the traffic load optimisation software, Group 2 cannot dominate Group 1a and accordingly does not appear on this dialog. Users who wish to combine traffic load patterns with horizontal forces determined outside of the optimisation facility can obtain Characteristic Group 2 results by using Frequent Group 1a, which uses the same factors.
- Group 3** comprises footway and cycle track loads only, which are excluded from the scope of the optimiser and so Group 3 does not appear on this dialog.

EN1991-2 Optional Code Settings Advanced

A representative dialog (Sweden) is shown. Options available on each dialog for other countries depend upon the design code and National Annex supported.

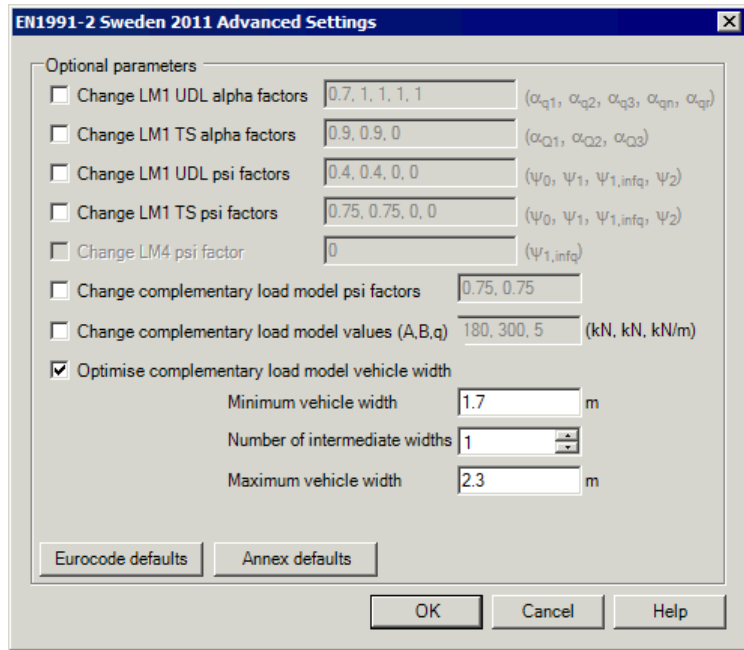

The Optional Code Settings Advanced dialog is used to view and modify α_Q , α_q and ψ factors or parameters associated with national complementary load models (if applicable) and to request additional output.

Optional parameters

- Adjustment factors (α) for Load Model 1 UDL are in the format $\alpha_{q1}, \alpha_{q2}, \alpha_{q3}, \alpha_{qn}, \alpha_{qr}$.
- Adjustment factors for Load Model 1 Tandem System are in the format $\alpha_{Q1}, \alpha_{Q2}, \alpha_{Q3}$.

The numerical subscripts in the above denote lane rank, starting with lane 1 (see EN1991-2 clause 4.2.4(4)).

- Multi-component (ψ) factors for Load Model 1 UDL and Tandem Systems are in the format: $\psi_0, \psi_1, \psi_{1,infq}$
- Multi-component (ψ) factors for Load Model 4 are in the format: $\psi_{1,infq}$

Additional options

For countries where the National Annex specifies a complementary load model under EN1991-2 clause 4.2.1(1) Note 2 (such as Sweden), additional options such as axle loads and multi-component factors may be given in this dialog.

For Sweden, the complementary load model vehicle width can be specified in terms of minimum and maximum width, and the number of intermediate widths to be considered.

For Denmark, three radio buttons permit specifying the carriageway division strategy for Group 5:

- Two remaining areas unequal** (default option) as stipulated by Danish National Annex A (Normative) Load Models for Classification and Assessment of Load-carrying Capacity, figure A2.2-1. This strategy produces lane arrangements with one or two remaining areas placed at either side of the kerbs, and because of potentially large amount of lane arrangements produced will take the most time to resolve.
- One remaining area** which can be placed next to one kerb or the other, or between lanes.
- Two remaining areas equal** will put the notional lanes in the centre of the carriageway, i.e. the remaining area will be split in two strips of the same width. This strategy tries one position only, and therefore is the fastest option.

Defaults

The **Eurocode defaults** and the **Annex defaults** buttons permit the viewing of Recommended Values from EN1991-2 or the values stated in the National Annex selected on the main dialog (apart from when the “Recommended Values” option was selected from the main dialog).

Using the checkboxes factors may also be entered manually to suit project requirements. In some cases values may be modified to suit national requirements until a particular National Annex is fully implemented and available for those countries not currently supported.

Optional Loading Parameters (all LUSAS TLO supported countries)

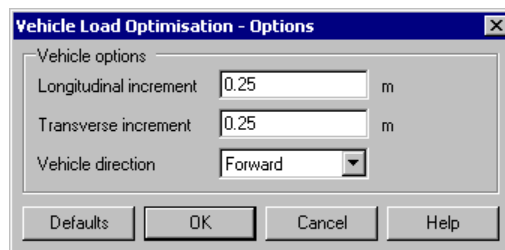

The optional loading parameters dialog allows longitudinal and transverse increments to be set which will determine the accuracy with which the most onerous load locations are calculated. A smaller increment will result in higher accuracy but with an extended processing time.

Vehicle direction (for non-symmetric special vehicles) may be given as **Forward**, **Reverse** or **Both**. The default is **Both**. Symmetric vehicles are not affected by this setting (and therefore the analysis is run only once for symmetric vehicles).

EN1991-2 Optional Code Settings - Denmark

The EN1991-2 Denmark 2015 code is supported by the LUSAS Traffic Load Optimisation software option.

EN1991-2 Denmark 2015

Selecting **EN1991-2 Denmark 2015** on the main Vehicle Load Optimisation dialog sets default values for NDPs and offers traffic load options according to Denmark standards:

- EN 1991-2 DK NA:2015 [V3] DS/EN 1990/A1 DK NA:2015 National Annex to Eurocode 0: Basis of structural design, Annex A2 Applications for Bridges, BaneDanmark/ Vejdirektoratet, 27 Apr 2015. [REF 1]
- DS/EN 1991-2 DK NA:2015 National Annex to Eurocode 1: Actions on structures – Part 2: Traffic load on bridges, BaneDanmark/ Vejdirektoratet, 1 May 2015 [REF 2]
- Annex A (Normative) Load Models for Classification and Assessment of Load-carrying Capacity, BaneDanmark/ Vejdirektoratet, [date not verified in the document] [REF 3]

Undocumented entries

See [Eurocode EN1991-2 Optional Code Settings](#) for any dialog entries not covered in this topic.

Bridge class for LM1 and LM3.

A selection of either 'Bridge class 1' or 'Bridge class 2' is required if, in 'Load groups to include', either "Group 1a - LM1" or "Group 5 - Danish LM3" is checked.

Load model 1

Adjustment factors (α) for Eurocode LM1 are based upon specification of the bridge as being either 'Class 1' or 'Class 2' ([REF 3] clause 4.3.2(3) NOTE 1 and NOTE 2). Hence the default values of (α) in the [Advanced Settings](#) dialog will change depending on the bridge class selected.

Danish load model 3

Special vehicles in LM3 are based upon specification of the bridge as being either 'Class 1' or 'Class 2' ([REF 3] clause 4.3.4(1)). This allows for setting:

- Standard** combination of vehicles for a selected bridge class.
- Custom** combination of vehicles, as specified by selecting Vehicle class for Vehicle A and B on the associated dropdown lists.

- Include associated UDL** (checked by default as per [REF 3] clause A2.2) states whether the associated UDL is included in conjunction with the custom vehicles selected.
- Passage type** options are Normal, Conditional type 1, Conditional type 2 and Conditional type 3 (Normal passage chosen by default). If Conditional type 3 is chosen, the dropdown list for vehicle selection B will be greyed out and disabled, even if the option Custom combination of vehicles is selected.
- Number of lanes in each carriageway** Specify the number of existing marked lanes in which the carriageway is divided. Only enabled if any of the Conditional passages is selected. (If normal passage is selected, the carriageway is divided in notional lanes as per [REF 3] figure A2.2-1. When there is more than 1 carriageway, all of them will be divided in the same number of lanes, regardless if the carriageways have different widths or not. The minimum allowable width of the lanes is 2.8 metres, because this is the maximum width of the vehicles, as per [REF 3] figures A2.3.1-1 and A2.3.1-2. To achieve this, the variable MIN_LANE_WIDTH in designCode.xml is set to 2.8. Therefore when a number of lanes are introduced such that the resulting width is below 2.8 metres, an error message is displayed.
- Consider alternative UDL-only patterns for large bridges** (if checked) states whether the separate verification of UDL only for large bridges is carried out as per [REF 3] clause A2.3.3. This is only enabled if Normal passage is selected, and is unchecked by default. [REF3] does not define this UDL for lengths lower or equal to 50m, but in the implementation it has been defined as 0. Therefore, if the user checks this checkbox, and the influence length is not greater than 50m (not a large bridge), the UDL will not be placed because it will never be more onerous than the normal loading (vehicles A and B with general UDL).

Dynamic effect

If "Group 5 – Danish LM3" is checked, the dynamic factor for the effect of Danish LM3 vehicles can be calculated or defined

- Calculate dynamic factor using**
 - **L from each influence selected** takes values that are user-defined in an extra column of the influence dialog. See Setting-up Influence Surfaces in the [Vehicle Load Optimisation Wizard](#).
 - **Single L for all influences** takes values that are defined in the adjacent text box.
 - **Speed of traffic** Only enabled if the passage type selected is either Conditional type 2, or Conditional type 3.
 - **Incorporate reduction for fill on deck** (if checked) allows the definition of **Thickness of fill**.

- ❑ **Enter dynamic factor** When selected allows a dynamic factor to be stated. Checks are made for values outside of the range ≥ 1.0 and ≤ 1.25 . 1.25 is the most conservative value (maximum factor that can be calculated according to [REF3] clause A2.3.5).

EN1991-2 Optional Code Settings - Ireland

This design code loading is supported by the LUSAS Traffic Load Optimisation software option.

Selecting **EN1991-2 Ireland 2010** on the main Vehicle Load Optimisation dialog sets default values for NDPs and offers traffic load options according to Irish National Annexes published under the authority of the NSAI. Traffic loading on bridges to the Eurocodes is specified in two main documents:

- **NA to IS EN1991-2:2003 (effective from 9 September 2009)**
- **NA to IS EN 1990:2002+A1:2005 (effective from 29 March 2010)**

Undocumented entries

See [Eurocode EN1991-2 Optional Code Settings](#) for any dialog entries not covered in this topic.

Load model 1

Adjustment factors for Load Model 1 (α_0 , α_q) are taken from NA to IS EN1991-2 Table NA.1. According to EN1991-2 clause 4.3.2 (3) Note 2, adjustment factors may correspond to classes of traffic. However, the adjustment factors in Table NA.1 are not dependent upon a selected traffic class and accordingly no traffic class options are offered on the dialog.

Load model 3

- Load Model 3 special vehicles (three SV and four SOV model vehicles) are described in the NA to IS EN1991-2 Fig NA.1 to NA.3 inclusive. One or more vehicles may be selected for use in the calculation of the most onerous load pattern. The selected vehicles are considered one at a time, being placed, together with associated Load Model 1 (switched on by default) according to the rules set out in clause NA.2.16.3.
- Each SV has a central axle spacing that varies (3 possible values). All such axle spacings are considered in calculation of the most onerous load effect. Each SOV has an axle spacing that varies continuously from 1.5 to 40m. By default, this axle spacing is calculated to an accuracy set in the Optional Loading Parameters dialog.

- Dynamic amplification factors (Table NA.2) are included in the calculation of the most onerous Group 5 load pattern and the wheel loads are accordingly factored within the vehicle (discrete point) loading attributes generated when the optimisation process is complete.
- When Group 5 is included, the SV80 is selected as a default. This vehicle is intended to model the effects of typical abnormal vehicles with a maximum gross weight of 80 tonnes and a maximum basic axle load of 12.5 tonnes (NA.2.16.1.1). Project requirements would dictate if this is the appropriate vehicle and the vehicle selection may need to be adjusted or expanded.

Complementary load model

According to EN1991-2 clause 4.2.1(1) Note 2, a complementary load model may be specified in the National Annex. No such complementary load model is described in the Irish National Annex.

Psi factors

Multi-component (ψ) factors are taken from NA to IS EN1990 Table NA.7. Infrequent values are not required (NA.2.3.3.1) and quasi-static values are not calculated since ψ_2 is given as zero for all traffic loads (Table NA.7). Group 4 loading is not included in the calculation of Frequent values (Note (2) to Table NA.7).

Restrictions on use

The traffic load models in EN1991-2 are applicable for bridges with loaded lengths less than 200m (clause 4.1(1)). In general the use of Load Model 1 is conservative for loaded lengths over 200m (4.1(1) note 1). The Irish National Annex states that Load Model 1 may be used for loaded lengths up to 1500m (NA to IS EN1991-2 clause NA2.6) and no information on load models appropriate beyond that length is given. Calculation of the most onerous load pattern will proceed regardless of the loaded length and therefore patterns generated may be inappropriate for very long loaded lengths.

EN1991-2 Optional Code Settings - Italy

This design code loading is supported by the LUSAS Traffic Load Optimisation software option.

Selecting **EN1991-2 Italy 2007** on the main Vehicle Load Optimisation dialog sets default values for NDPs and offers traffic load options according to Italian National Annexes published by UNI:

- **UNI-EN-1991 – 2 – Eurocodice 1 – Azioni sulle strutture – Parte 2 – Carichi da traffico sui ponti: Appendice nazionale (27 luglio 2007)**
- **UNI-EN-1990 – Criteri generali di progettazione strutturale – Appendice A2 – Applicazioni ai ponti: Appendice nazionale (27 luglio 2007)**

Undocumented entries

See [Eurocode EN1991-2 Optional Code Settings](#) for any dialog entries not covered in this topic.

Load model 1

Adjustment factors for Load Model 1 (α_0 , α_q) correspond to traffic class is view of EN1991-2 clause 4.3.2 (3) note 2. Selecting traffic class 1 or class 2 on the dialog results in adjustment factors of 1.0 or 0.8 respectively in accordance with UNI-EN1991-2.

Load model 3

In relation to EN1991-2 clause 4.3.4(1), the Italian National Annex states “When significant, use the special vehicles and rules for application provided in Annex A (informative)”. Accordingly, Load Model 3 special vehicles are taken from EN1991-2 Annex A (informative) Tables A1 and A2. The notes and restrictions for this load model described under “Recommended Values” also apply to EN1991-2 Italy.

Complementary load model

According to EN1991-2 clause 4.2.1(1) Note 2, a complementary load model may be specified in the National Annex. No such complementary load model is described in the Italian National Annex.

Psi factors

Multi-component (ψ) factors are taken from EN1990 Table A2.1 since the Italian National Annex states that the recommended values should be adopted. Infrequent values are not required (A2.2.2(1) note) and quasi-static values are not calculated since ψ_2 is given as zero for all traffic loads (EN1990 Table A2). Group 4 loading is not included in the calculation of Frequent values for the reason described under “Recommended Values”.

Restrictions on use

The traffic load models in EN1991-2 are applicable for bridges with loaded lengths less than 200m (clause 4.1(1)). In general the use of Load Model 1 is safe-sided for loaded lengths over 200m (4.1(1) note 1). The Italian National Annex defines a load model which is less conservative than Load Model 1 for structures with loaded lengths > 300m. This alternative Load model is not implemented. Calculation of the most onerous load pattern will proceed using the selected EN1991-2 load models regardless of the loaded length and therefore patterns generated may be over-conservative for very long loaded lengths.

EN1991-2 Optional Code Settings - Norway 2010 + NA-rundskriv 07-2015

This design code loading is supported by the LUSAS Traffic Load Optimisation software option.

Selecting **EN1991-2 Norway 2010 + NA-rundskriv 07-2015** on the main Vehicle Load Optimisation dialog sets default values for NDPs, and special vehicles according to the following:

- **NS-EN 1991-2.2003 NA 2010 Eurokode 1: Laster på konstruksjoner - Del 2: Trafikklast på bruer**
- **NS EN 1990-2002 A1 2005 NA 2016 Eurokode: Grunnlag for prosjektering av konstruksjoner**
- **NA Circular 07/2015 Traffic Load in manual N400 Bruprosjektering State Highways Authority of Norway**

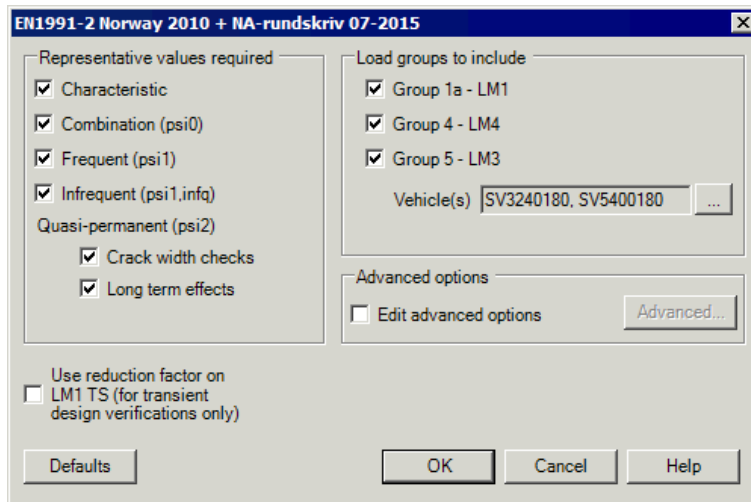

Undocumented entries

See [Eurocode EN1991-2 Optional Code Settings](#) for any dialog entries not covered in this topic.

Quasi-permanent

There are two quasi-permanent design cases:

- Crack width checks
- Long term effects

Load model 3

- In Group 5 - LM3, different vehicles are available. Instead of the recommended ones of the Eurocode, NA Circular 07/2015 Traffic Load in manual N400 Bruprosjektering State Highways Authority of Norway, April 2015 defines two special vehicles: SV3240180 and SV5400180.

EN1991-2 Optional Code Settings - Poland

This design code loading is supported by the LUSAS Traffic Load Optimisation software option.

Selecting **EN1991-2 Poland 2008** on the main Vehicle Load Optimisation dialog sets default values for NDPs and offers traffic load options according to recommendations in EN1991-2 and EN1990, and offers Load Model 3 Special Vehicles from the informative Annex A to EN1991-2. This is because PN-EN 1991-2:2007 and PN-EN 1990:2004/A1:2008 published by PKN state that European Norms have the status of Polish Norms, with no modification from the English version of the European Norms.

All notes on [Eurocode EN1991-2 Recommended Values](#) are therefore also applicable to “EN1991-2 Poland 2008”.

EN1991-2 Optional Code Settings - Recommended Values

This design code loading is supported by the LUSAS Traffic Load Optimisation software option.

Selecting **EN1991-2 Recommended Values 2009** on the main Vehicle Load Optimisation dialog sets default values for NDPs according to recommendations in EN1991-2 and EN1990, and offers traffic load options from the informative Annex A to EN1990, as per the CEN documents published by the British Standards Institution.

- **BS EN 1991-2:2003 Eurocode 1: Actions on structures — Part 2: Traffic loads on bridges, Incorporating Corrigendum No. 1 (published 15 December 2004)**
- **BS EN 1990:2002+A1:2005 Eurocode — Basis of structural design, Incorporating corrigendum (published 30 June 2009)**

The default values may be modified as necessary making the “Recommended Values” option useful for countries where a National Annex is not yet published or is not yet supported.

Undocumented entries

See [Eurocode EN1991-2 Optional Code Settings](#) for any dialog entries not covered in this topic.

Load model 1

Adjustment factors for Load Model 1 (α_Q , α_{q_i}) are taken as 1.0, based on EN1991-2 clause 4.3.2 (3) Note 1. With respect to Note 2; no traffic class options are offered on the dialog but the adjustment factors may be modified in the optional code settings “advanced” dialog.

Load model 3

- Load Model 3 special vehicles are taken from EN1991-2 Annex A (informative) Tables A1 and A2. Each table lists 17 vehicles, however a conflict in the last lines of the two tables means that effectively 18 vehicles are described and accordingly there are 18 vehicles of fixed axle spacing listed in the dialog. One or more vehicles may be selected for use in the calculation of the most onerous load pattern. The selected vehicles are considered one at a time, being placed together with associated Load Model 1 (switched on by default) according to the rules set out in clause A.3 considering low speed transit only (clauses A.3(5) and A.3(7) are not applied).
- When Group 5 is included, the SV1800200 is selected as a default. This vehicle has a gross weight of 180 tonnes and an axle load of 20 tonnes, and is selected only as an example – on the basis that the heaviest vehicles in the Annex are exceptional and the least heavy are covered by the effects of Load model 1 (clause A.2 (2), note 2). Project requirements typically dictate the appropriate vehicle and so the vehicle selection may need to be modified.
- Dynamic amplification (clause A.3(5)) is not used for low speed transit and so is not included in the calculation of the most onerous Group 5 load pattern.

Psi factors

Multi-component (ψ) factors are taken from EN1990 Table A2.1. Infrequent values are not currently implemented (note 2 under table A2.1 is not applied) and quasi-static values are not calculated since ψ_2 is given as zero for all traffic loads (Table A2.1). In EN1990 Table A2.1, the frequent value of Group 4 loading is indicated with ψ_1 factor. However in EN1991-2 Table 4.4a and 4.4b, Group 4 loading is not required in the calculation of Frequent values. This conflict has been resolved by excluding Group 4 from the calculation of frequent values.

Restrictions on use

The traffic load models in EN1991-2 are applicable for bridges with loaded lengths less than 200m (clause 4.1(1)). In general the use of Load Model 1 is conservative for loaded lengths over 200m (4.1(1) Note 1). Calculation of the most onerous load

pattern will proceed regardless of the loaded length, and therefore patterns generated may be inappropriate for very long loaded lengths.

EN1991-2 Optional Code Settings - Sweden

EN1991-2 Sweden 2009 and EN1991-2 Sweden 2011 codes are supported by the LUSAS Traffic Load Optimisation software option.

EN1991-2 Sweden 2009

Selecting **EN1991-2 Sweden 2009** on the main Vehicle Load Optimisation dialog sets default values for NDPs and offers traffic load options according to Swedish standards:

- **Specifikation SIS/PAS NA, EN 1991-2:2003 Swedish National Annex NA to Eurocode EN 1991-2:2003 – Traffic loads on bridges, Utgåva 1 (First Edition), Publicerad: maj 2007**
- **VV2009:19 Updated rules for use of Eurocodes on highway projects; Utkom från trycket den 26 juni 2009**
- **VV2009:27 TK Bro; Datum 2009-07-01**

For the purpose of traffic loading optimisation, within the scope described above, the Swedish National Annex to EN1991-2, published by SIS in May 2007, is considered identical to VV2009:19.

Undocumented entries

See [Eurocode EN1991-2 Optional Code Settings](#) for any dialog entries not covered in this topic.

Load model 1

Adjustment factors for Load Model 1 (α_Q, α_q) are taken from SIS/PAS NA to EN 1991-2:2003 clause 4.3.2(3); the same values are given in VVFS 2009:19 Chapter 6, clause 4, Tabell 7.1. According to EN1991-2 clause 4.3.2 (3) note 2, adjustment factors may correspond to classes of traffic. However, the adjustment factors in the Swedish documents are not dependent upon a selected traffic class and accordingly no traffic class options are offered on the dialog.

Load model 3

Load Model 3 special vehicles. TK Bro VV2009:27 clause B.3.4.1.3(e) states that other load models do not apply. However SIS/PAS NA to EN 1991-2 clause 4.3.4(1) allows for the client to specify values for the individual project; VV2009:19 Chapter 6 clause 2 says the same. For flexibility, Load Model 3 Special Vehicles from EN1991-2 Annex A (informative) Tables A1 and A2 are available (although Group 5 is switched

off by default). The notes and restrictions for this load model described under **Recommended Values** also apply to EN1991-2 Sweden.

Complementary load model

According to EN1991-2 clause 4.2.1(1) Note 2, a complementary load model may be specified in the National Annex. SIS/PAS NA to EN1991-2 describes a Swedish complementary load model; TK Bro VV2009:27 clause B.3.4.1.3(d) refers to VV2004:43 (superseded by VV2009:19) and VV2009:19 Chapter 6, clause 3 (page 13) repeats the information from the SIS/PAS National Annex.

- The Swedish complementary load model consists of 12 vehicles (type a to type l inclusive). One or more vehicles may be selected for use in the calculation of the most onerous load pattern. The selected vehicle types are considered one type at a time. A single vehicle is placed in the most onerous lane (with lane factor 1.0) with another vehicle of the same type placed in the second most onerous lane (with lane factor 0.8). Uniformly distributed load (q) is placed in adverse areas of lanes 1 and 2, if appropriate, and also in adverse areas of other lanes.
- A number of the complementary load model vehicles have an axle spacing which varies continuously from a stated minimum value, with no set maximum value. By default, this axle spacing is calculated to an accuracy set in the **Optional Loading Parameters** dialog. All complementary load vehicles have axle width that may vary between 1.7 and 2.3m (measured to the centre of action of each wheel load). Minimum and maximum widths can be tested for a specified number of intermediate widths. These widths can be modified in the **Optional Code Settings Advanced** dialog.
- A dynamic amplification factor is applied to the vehicles (not the uniformly distributed load, q) in the calculation of the most onerous Swedish complementary load model pattern and the wheel loads are accordingly factored within the vehicle (discrete point) loading attributes generated when the optimisation process is complete. The dynamic factor entered on the dialog should be calculated from the equation in SIS/PAS NA or VV2009:19 Chapter 6, clause 3. The default value of 35% reflects the maximum allowable value.
- Using the **Optional Code Settings Advanced** dialog, it is possible to view and modify the values used for A, B and q in the complementary load model.
- When the Swedish Complementary Load model is included, all 12 vehicles are selected by default. This means that the most onerous of the 12 will be identified so that the structural element under consideration can be “designed for the type vehicle that causes the most unfavourable influence” (EN1991-2 clause 4.2.1(1) Note 2). The number of vehicles selected for the optimisation may be reduced using the dialog provided, as appropriate to project requirements.

- It is noted that the Swedish complementary load model vehicles are identical to the “classification loads” of VV2009:61 Clause 2.3.2.2.1 (and Annex 2). However, for classification, VV2009:61 Clause 1.1.5.3 requires the engineer to calculate the maximum values of load magnitudes “A” and “B” that can be carried (also referring to VV2009:62 (MB803) for exceptional loads). Such a calculation is not automated, although values of A and B can be modified as described above.

Psi factors

Multi-component (ψ) factors are generally taken from EN1990 Table A2.1 since the note under VVFS 2009:19 Chapter 7, clause 5, Tabell A2.(S) states that “at least the recommended levels apply”. Infrequent values are not required (SIS/PAS NA, EN 1991-2:2003 clause 2.2(2)) and quasi-static values are not calculated since ψ_2 is given as zero for all traffic loads (EN1990 Table A2). Group 4 loading is not included in the calculation of Frequent values for the reason described under “Recommended Values”.

Multi-component (ψ) factors for the Swedish Complementary load model are taken from TK Bro VV2009:27 Clause B.2.1.2.2. Based on the values given (ψ_0 and ψ_1 but $\psi_2 = 0$), the complementary load model is included in the calculation of characteristic, combination and frequent values, but quasi-static values are not required.

Obtaining most onerous load patterns

The most onerous load patterns returned to the model after the optimisation process are based on a comparison of the Swedish complementary load model (using the selected type vehicles) and any other selected Eurocode load models (Group 1a, Group 4, Group 5). If it is desirable to view the most onerous of each load group, the check box on the Optional Code Settings Advanced dialog should be used.

Restrictions on use

The traffic load models in EN1991-2 are applicable for bridges with loaded lengths less than 200m (clause 4.1(1)). In general the use of Load Model 1 is conservative for loaded lengths over 200m (4.1(1) note 1). In TK Bro VV2009:27 clause B.3.4.1.3.(b) a load model for bridges of span >200m is given, However, this alternative Load model is not implemented. Calculation of the most onerous load pattern will proceed using the EN1991-2 load models and the Swedish Complementary load model, as selected, regardless of the loaded length and therefore patterns generated may be inappropriate for very long loaded lengths.

EN1991-2 Sweden 2011

Selecting **EN1991-2 Sweden 2011** sets default values for NDPs and offers traffic load options according to Swedish standard:

- **TRVFS2011:12 Updated rules for use of Eurocodes on highway projects (Trafikverket, Oct 2011)**

TRVFS2011:12 supersedes VV2009:19 for the implementation of highway traffic loading to the Eurocodes in Sweden. However, in fact the implementation is as described in “EN1991-2 Sweden 2009” above, except for the following modifications:

1. The Swedish complementary load model in TRVFS2011:12 Appendix 3 consists of 14 vehicles (type a to type n inclusive). Vehicle types a to l are as VV2009:19; vehicles type m and n, with fixed axle spacings, have been added.
2. The dynamic amplification factor in TRVFS2011:12 Chapter 6, clause 3 is set at a constant 20%. The default value reflects this change from the maximum of 35% in VV2009:19.
3. Multi-component (ψ) factors for the Swedish Complementary load model are given in TRVFS2011:12 Chapter 7, clause 5 (previously these were only found in TK Bro VV2009:27). However, values are identical in the two documents.

EN1991-2 Optional Code Settings - United Kingdom

This design code loading is supported by the LUSAS Traffic Load Optimisation software option.

Selecting **EN1991-2 UK 2009** on the main Vehicle Load Optimisation dialog sets default values for NDPs and offers traffic load options according to UK National Annexes published by BSI:

- **UK NA to BS EN1991-2:2003 incorporating corrigendum No 1 (May 2008)**
- **UK NA to BS EN 1990:2002+A1:2005 incorporating National Amendment No. 1 (June 2009)**

Undocumented entries

See [Eurocode EN1991-2 Optional Code Settings](#) for any dialog entries not covered in this topic.

Load model 1

Adjustment factors for Load Model 1 (α_Q , α_q) are taken from NA to BS EN1991-2 Table NA.1. According to EN1991-2 clause 4.3.2 (3) note 2, adjustment factors may correspond to classes of traffic. However, the adjustment factors in Table NA.1 are not dependent upon a selected traffic class and accordingly no traffic class options are offered on the dialog.

Load model 3

Load Model 3 special vehicles (three SV and four SOV model vehicles) are described in NA to BS EN1991-2 Fig NA.1 to NA.3 inclusive. One or more vehicles may be selected for use in the calculation of the most onerous load pattern. The selected

vehicles are considered one at a time, being placed, together with associated Load Model 1 (switched on by default) according to the rules set out in clause NA.2.16.4.

Each SV has a central axle spacing which varies (3 possible values). All such axle spacings are considered in calculation of the most onerous load effect. Each SOV has an axle spacing which varies continuously from 1.5 to 40m. By default, this axle spacing is calculated to an accuracy set in the Optional Loading Parameters dialog.

Dynamic amplification factors (Table NA.2) are included in the calculation of the most onerous Group 5 load pattern and the wheel loads are accordingly factored within the vehicle (discrete point) loading attributes generated when the optimisation process is complete.

When Group 5 is included, the SV80 is selected as a default. This vehicle is intended to model the effects of STGO Category 2 vehicles with a maximum gross weight of 80 tonnes and a maximum basic axle load of 12.5 tonnes (NA.2.16.1.1). Project requirements would dictate if this is the appropriate vehicle and the vehicle selection may need to be adjusted or expanded.

According to EN1991-2 clause 4.2.1(1) Note 2, a complementary load model may be specified in the National Annex. No such complementary load model is described in the UK National Annex.

Psi factors

Multi-component (ψ) factors are taken from NA to BS EN1990 Table NA.A2.1. Infrequent values are not required (NA.2.3.6.2) and quasi-static values are not calculated since ψ_2 is given as zero for all traffic loads (Table NA.A2.1). Group 4 loading is not included in the calculation of Frequent values (note b to Table NA.A2.1).

Restrictions on use

The traffic load models in EN1991-2 are applicable for bridges with loaded lengths less than 200m (clause 4.1(1)). In general the use of Load Model 1 is safe-sided for loaded lengths over 200m (4.1(1) note 1). The UK National Annex states that Load Model 1 may be used for loaded lengths up to 1500m (NA to BS EN1991-2 clause NA2.6) and no information on load models appropriate beyond that length is given. Calculation of the most onerous load pattern will proceed regardless of the loaded length and therefore patterns generated may be inappropriate for very long loaded lengths.

Notes on implemented National Annexes

Notes relating to the implementation of the National Annexes are provided for the following European EN1991-2 design code options:

- Ireland**
- Italy**

- [Poland](#)
- [Recommended Values](#)
- [Sweden](#)
- [UK](#)

EN1991-2 Optional Code Settings - Denmark

The EN1991-2 Denmark 2015 code is supported by the LUSAS Traffic Load Optimisation software option.

EN1991-2 Denmark 2015

Selecting **EN1991-2 Denmark 2015** on the main Vehicle Load Optimisation dialog sets default values for NDPs and offers traffic load options according to Denmark standards:

- EN 1991-2 DK NA:2015 [V3] DS/EN 1990/A1 DK NA:2015 National Annex to Eurocode 0: Basis of structural design, Annex A2 Applications for Bridges, BaneDanmark/ Vejdirektoratet, 27 Apr 2015. [REF 1]
- DS/EN 1991-2 DK NA:2015 National Annex to Eurocode 1: Actions on structures – Part 2: Traffic load on bridges, BaneDanmark/ Vejdirektoratet, 1 May 2015 [REF 2]
- Annex A (Normative) Load Models for Classification and Assessment of Load-carrying Capacity, BaneDanmark/ Vejdirektoratet, [date not verified in the document] [REF 3]

Undocumented entries

See [Eurocode EN1991-2 Optional Code Settings](#) for any dialog entries not covered in this topic.

Bridge class for LM1 and LM3.

A selection of either 'Bridge class 1' or 'Bridge class 2' is required if, in 'Load groups to include', either "Group 1a - LM1" or "Group 5 - Danish LM3" is checked.

Load model 1

Adjustment factors (α) for Eurocode LM1 are based upon specification of the bridge as being either 'Class 1' or 'Class 2' ([REF 3] clause 4.3.2(3) NOTE 1 and NOTE 2). Hence the default values of (α) in the [Advanced Settings](#) dialog will change depending on the bridge class selected.

Danish load model 3

Special vehicles in LM3 are based upon specification of the bridge as being either 'Class 1' or 'Class 2' ([REF 3] clause 4.3.4(1)). This allows for setting:

- Standard** combination of vehicles for a selected bridge class.
- Custom** combination of vehicles, as specified by selecting Vehicle class for Vehicle A and B on the associated dropdown lists.
- Include associated UDL** (checked by default as per [REF 3] clause A2.2) states whether the associated UDL is included in conjunction with the custom vehicles selected.
- Passage type** options are Normal, Conditional type 1, Conditional type 2 and Conditional type 3 (Normal passage chosen by default). If Conditional type 3 is chosen, the dropdown list for vehicle selection B will be greyed out and disabled, even if the option Custom combination of vehicles is selected.
- Number of lanes in each carriageway** Specify the number of existing marked lanes in which the carriageway is divided. Only enabled if any of the Conditional passages is selected. (If normal passage is selected, the carriageway is divided in notional lanes as per [REF 3] figure A2.2-1. When there is more than 1 carriageway, all of them will be divided in the same number of lanes, regardless if the carriageways have different widths or not. The minimum allowable width of the lanes is 2.8 metres, because this is the maximum width of the vehicles, as per [REF 3] figures A2.3.1-1 and A2.3.1-2. To achieve this, the variable MIN_LANE_WIDTH in designCode.xml is set to 2.8. Therefore when a number of lanes are introduced such that the resulting width is below 2.8 metres, an error message is displayed.
- Consider alternative UDL-only patterns for large bridges** (if checked) states whether the separate verification of UDL only for large bridges is carried out as per [REF 3] clause A2.3.3. This is only enabled if Normal passage is selected, and is unchecked by default. [REF3] does not define this UDL for lengths lower or equal to 50m, but in the implementation it has been defined as 0. Therefore, if the user checks this checkbox, and the influence length is not greater than 50m (not a large bridge), the UDL will not be placed because it will never be more onerous than the normal loading (vehicles A and B with general UDL).

Dynamic effect

If "Group 5 – Danish LM3" is checked, the dynamic factor for the effect of Danish LM3 vehicles can be calculated or defined

- Calculate dynamic factor using**
 - **L from each influence selected** takes values that are user-defined in an extra column of the influence dialog. See Setting-up Influence Surfaces in the [Vehicle Load Optimisation Wizard](#).
 - **Single L for all influences** takes values that are defined in the adjacent text box.
 - **Speed of traffic** Only enabled if the passage type selected is either Conditional type 2, or Conditional type 3.

- **Incorporate reduction for fill on deck** (if checked) allows the definition of **Thickness of fill**.

- **Enter dynamic factor** When selected allows a dynamic factor to be stated. Checks are made for values outside of the range ≥ 1.0 and ≤ 1.25 . 1.25 is the most conservative value (maximum factor that can be calculated according to [REF3] clause A2.3.5.

EN1991-2 Optional Code Settings - Ireland

This design code loading is supported by the LUSAS Traffic Load Optimisation software option.

Selecting **EN1991-2 Ireland 2010** on the main Vehicle Load Optimisation dialog sets default values for NDPs and offers traffic load options according to Irish National Annexes published under the authority of the NSAI. Traffic loading on bridges to the Eurocodes is specified in two main documents:

- **NA to IS EN1991-2:2003 (effective from 9 September 2009)**
- **NA to IS EN 1990:2002+A1:2005 (effective from 29 March 2010)**

Undocumented entries

See [Eurocode EN1991-2 Optional Code Settings](#) for any dialog entries not covered in this topic.

Load model 1

Adjustment factors for Load Model 1 (α_0 , α_q) are taken from NA to IS EN1991-2 Table NA.1. According to EN1991-2 clause 4.3.2 (3) Note 2, adjustment factors may correspond to classes of traffic. However, the adjustment factors in Table NA.1 are not dependent upon a selected traffic class and accordingly no traffic class options are offered on the dialog.

Load model 3

- Load Model 3 special vehicles (three SV and four SOV model vehicles) are described in the NA to IS EN1991-2 Fig NA.1 to NA.3 inclusive. One or more vehicles may be selected for use in the calculation of the most onerous load pattern. The selected vehicles are considered one at a time, being placed, together with associated Load Model 1 (switched on by default) according to the rules set out in clause NA.2.16.3.
- Each SV has a central axle spacing that varies (3 possible values). All such axle spacings are considered in calculation of the most onerous load effect. Each SOV has an axle spacing that varies continuously from 1.5 to 40m. By

default, this axle spacing is calculated to an accuracy set in the Optional Loading Parameters dialog.

- Dynamic amplification factors (Table NA.2) are included in the calculation of the most onerous Group 5 load pattern and the wheel loads are accordingly factored within the vehicle (discrete point) loading attributes generated when the optimisation process is complete.
- When Group 5 is included, the SV80 is selected as a default. This vehicle is intended to model the effects of typical abnormal vehicles with a maximum gross weight of 80 tonnes and a maximum basic axle load of 12.5 tonnes (NA.2.16.1.1). Project requirements would dictate if this is the appropriate vehicle and the vehicle selection may need to be adjusted or expanded.

Complementary load model

According to EN1991-2 clause 4.2.1(1) Note 2, a complementary load model may be specified in the National Annex. No such complementary load model is described in the Irish National Annex.

Psi factors

Multi-component (ψ) factors are taken from NA to IS EN1990 Table NA.7. Infrequent values are not required (NA.2.3.3.1) and quasi-static values are not calculated since ψ_2 is given as zero for all traffic loads (Table NA.7). Group 4 loading is not included in the calculation of Frequent values (Note (2) to Table NA.7).

Restrictions on use

The traffic load models in EN1991-2 are applicable for bridges with loaded lengths less than 200m (clause 4.1(1)). In general the use of Load Model 1 is conservative for loaded lengths over 200m (4.1(1) note 1). The Irish National Annex states that Load Model 1 may be used for loaded lengths up to 1500m (NA to IS EN1991-2 clause NA.2.6) and no information on load models appropriate beyond that length is given. Calculation of the most onerous load pattern will proceed regardless of the loaded length and therefore patterns generated may be inappropriate for very long loaded lengths.

EN1991-2 Optional Code Settings - Italy

This design code loading is supported by the LUSAS Traffic Load Optimisation software option.

Selecting **EN1991-2 Italy 2007** on the main Vehicle Load Optimisation dialog sets default values for NDPs and offers traffic load options according to Italian National Annexes published by UNI:

- **UNI-EN-1991 – 2 – Eurocodice 1 – Azioni sulle strutture – Parte 2 – Carichi da traffico sui ponti: Appendice nazionale (27 luglio 2007)**

- **UNI-EN-1990 – Criteri generali di progettazione strutturale – Appendice A2 – Applicazioni ai ponti: Appendice nazionale (27 luglio 2007)**

Undocumented entries

See [Eurocode EN1991-2 Optional Code Settings](#) for any dialog entries not covered in this topic.

Load model 1

Adjustment factors for Load Model 1 (α_0 , α_q) correspond to traffic class is view of EN1991-2 clause 4.3.2 (3) note 2. Selecting traffic class 1 or class 2 on the dialog results in adjustment factors of 1.0 or 0.8 respectively in accordance with UNI-EN1991-2.

Load model 3

In relation to EN1991-2 clause 4.3.4(1), the Italian National Annex states “When significant, use the special vehicles and rules for application provided in Annex A (informative)”. Accordingly, Load Model 3 special vehicles are taken from EN1991-2 Annex A (informative) Tables A1 and A2. The notes and restrictions for this load model described under “Recommended Values” also apply to EN1991-2 Italy.

Complementary load model

According to EN1991-2 clause 4.2.1(1) Note 2, a complementary load model may be specified in the National Annex. No such complementary load model is described in the Italian National Annex.

Psi factors

Multi-component (ψ) factors are taken from EN1990 Table A2.1 since the Italian National Annex states that the recommended values should be adopted. Infrequent values are not required (A2.2.2(1) note) and quasi-static values are not calculated since ψ_2 is given as zero for all traffic loads (EN1990 Table A2). Group 4 loading is not included in the calculation of Frequent values for the reason described under “Recommended Values”.

Restrictions on use

The traffic load models in EN1991-2 are applicable for bridges with loaded lengths less than 200m (clause 4.1(1)). In general the use of Load Model 1 is safe-sided for loaded lengths over 200m (4.1(1) note 1). The Italian National Annex defines a load model which is less conservative than Load Model 1 for structures with loaded lengths > 300 m. This alternative Load model is not implemented. Calculation of the most onerous load pattern will proceed using the selected EN1991-2 load models regardless of the loaded length and therefore patterns generated may be over-conservative for very long loaded lengths.

EN1991-2 Optional Code Settings - Poland

This design code loading is supported by the LUSAS Traffic Load Optimisation software option.

Selecting **EN1991-2 Poland 2008** on the main Vehicle Load Optimisation dialog sets default values for NDPs and offers traffic load options according to recommendations in EN1991-2 and EN1990, and offers Load Model 3 Special Vehicles from the informative Annex A to EN1991-2. This is because PN-EN 1991-2:2007 and PN-EN 1990:2004/A1:2008 published by PKN state that European Norms have the status of Polish Norms, with no modification from the English version of the European Norms.

All notes on [Eurocode EN1991-2 Recommended Values](#) are therefore also applicable to “EN1991-2 Poland 2008”.

EN1991-2 Optional Code Settings - Recommended Values

This design code loading is supported by the LUSAS Traffic Load Optimisation software option.

Selecting **EN1991-2 Recommended Values 2009** on the main Vehicle Load Optimisation dialog sets default values for NDPs according to recommendations in EN1991-2 and EN1990, and offers traffic load options from the informative Annex A to EN1990, as per the CEN documents published by the British Standards Institution.

- **BS EN 1991-2:2003 Eurocode 1: Actions on structures — Part 2: Traffic loads on bridges, Incorporating Corrigendum No. 1 (published 15 December 2004)**
- **BS EN 1990:2002+A1:2005 Eurocode — Basis of structural design, Incorporating corrigendum (published 30 June 2009)**

The default values may be modified as necessary making the “Recommended Values” option useful for countries where a National Annex is not yet published or is not yet supported.

Undocumented entries

See [Eurocode EN1991-2 Optional Code Settings](#) for any dialog entries not covered in this topic.

Load model 1

Adjustment factors for Load Model 1 (α_0, α_q) are taken as 1.0, based on EN1991-2 clause 4.3.2 (3) Note 1. With respect to Note 2; no traffic class options are offered on the dialog but the adjustment factors may be modified in the optional code settings “advanced” dialog.

Load model 3

- Load Model 3 special vehicles are taken from EN1991-2 Annex A (informative) Tables A1 and A2. Each table lists 17 vehicles, however a conflict in the last lines of the two tables means that effectively 18 vehicles are described and accordingly there are 18 vehicles of fixed axle spacing listed in the dialog. One or more vehicles may be selected for use in the calculation of the most onerous load pattern. The selected vehicles are considered one at a time, being placed together with associated Load Model 1 (switched on by default) according to the rules set out in clause A.3 considering low speed transit only (clauses A.3(5) and A.3(7) are not applied).
- When Group 5 is included, the SV1800200 is selected as a default. This vehicle has a gross weight of 180 tonnes and an axle load of 20 tonnes, and is selected only as an example – on the basis that the heaviest vehicles in the Annex are exceptional and the least heavy are covered by the effects of Load model 1 (clause A.2 (2), note 2). Project requirements typically dictate the appropriate vehicle and so the vehicle selection may need to be modified.
- Dynamic amplification (clause A.3(5)) is not used for low speed transit and so is not included in the calculation of the most onerous Group 5 load pattern.

Psi factors

Multi-component (ψ) factors are taken from EN1990 Table A2.1. Infrequent values are not currently implemented (note 2 under table A2.1 is not applied) and quasi-static values are not calculated since ψ_2 is given as zero for all traffic loads (Table A2.1). In EN1990 Table A2.1, the frequent value of Group 4 loading is indicated with ψ_1 factor. However in EN1991-2 Table 4.4a and 4.4b, Group 4 loading is not required in the calculation of Frequent values. This conflict has been resolved by excluding Group 4 from the calculation of frequent values.

Restrictions on use

The traffic load models in EN1991-2 are applicable for bridges with loaded lengths less than 200m (clause 4.1(1)). In general the use of Load Model 1 is conservative for loaded lengths over 200m (4.1(1) Note 1). Calculation of the most onerous load pattern will proceed regardless of the loaded length, and therefore patterns generated may be inappropriate for very long loaded lengths.

EN1991-2 Optional Code Settings - Sweden

EN1991-2 Sweden 2009 and EN1991-2 Sweden 2011 codes are supported by the LUSAS Traffic Load Optimisation software option.

EN1991-2 Sweden 2009

Selecting **EN1991-2 Sweden 2009** on the main Vehicle Load Optimisation dialog sets default values for NDPs and offers traffic load options according to Swedish standards:

- **Specifikation SIS/PAS NA, EN 1991-2:2003 Swedish National Annex NA to Eurocode EN 1991-2:2003 – Traffic loads on bridges, Utgåva 1 (First Edition), Publicerad: maj 2007**
- **VV2009:19 Updated rules for use of Eurocodes on highway projects; Utkom från trycket den 26 juni 2009**
- **VV2009:27 TK Bro; Datum 2009-07-01**

For the purpose of traffic loading optimisation, within the scope described above, the Swedish National Annex to EN1991-2, published by SIS in May 2007, is considered identical to VV2009:19.

Undocumented entries

See [Eurocode EN1991-2 Optional Code Settings](#) for any dialog entries not covered in this topic.

Load model 1

Adjustment factors for Load Model 1 (α_Q, α_q) are taken from SIS/PAS NA to EN 1991-2:2003 clause 4.3.2(3); the same values are given in VVFS 2009:19 Chapter 6, clause 4, Tabell 7.1. According to EN1991-2 clause 4.3.2 (3) note 2, adjustment factors may correspond to classes of traffic. However, the adjustment factors in the Swedish documents are not dependent upon a selected traffic class and accordingly no traffic class options are offered on the dialog.

Load model 3

Load Model 3 special vehicles. TK Bro VV2009:27 clause B.3.4.1.3(e) states that other load models do not apply. However SIS/PAS NA to EN 1991-2 clause 4.3.4(1) allows for the client to specify values for the individual project; VV2009:19 Chapter 6 clause 2 says the same. For flexibility, Load Model 3 Special Vehicles from EN1991-2 Annex A (informative) Tables A1 and A2 are available (although Group 5 is switched off by default). The notes and restrictions for this load model described under [Recommended Values](#) also apply to EN1991-2 Sweden.

Complementary load model

According to EN1991-2 clause 4.2.1(1) Note 2, a complementary load model may be specified in the National Annex. SIS/PAS NA to EN1991-2 describes a Swedish complementary load model; TK Bro VV2009:27 clause B.3.4.1.3(d) refers to

VV2004:43 (superseded by VV2009:19) and VV2009:19 Chapter 6, clause 3 (page 13) repeats the information from the SIS/PAS National Annex.

- The Swedish complementary load model consists of 12 vehicles (type a to type l inclusive). One or more vehicles may be selected for use in the calculation of the most onerous load pattern. The selected vehicle types are considered one type at a time. A single vehicle is placed in the most onerous lane (with lane factor 1.0) with another vehicle of the same type placed in the second most onerous lane (with lane factor 0.8). Uniformly distributed load (q) is placed in adverse areas of lanes 1 and 2, if appropriate, and also in adverse areas of other lanes.
- A number of the complementary load model vehicles have an axle spacing which varies continuously from a stated minimum value, with no set maximum value. By default, this axle spacing is calculated to an accuracy set in the **Optional Loading Parameters** dialog. All complementary load vehicles have axle width that may vary between 1.7 and 2.3m (measured to the centre of action of each wheel load). Minimum and maximum widths can be tested for a specified number of intermediate widths. These widths can be modified in the **Optional Code Settings Advanced** dialog.
- A dynamic amplification factor is applied to the vehicles (not the uniformly distributed load, q) in the calculation of the most onerous Swedish complementary load model pattern and the wheel loads are accordingly factored within the vehicle (discrete point) loading attributes generated when the optimisation process is complete. The dynamic factor entered on the dialog should be calculated from the equation in SIS/PAS NA or VV2009:19 Chapter 6, clause 3. The default value of 35% reflects the maximum allowable value.
- Using the **Optional Code Settings Advanced** dialog, it is possible to view and modify the values used for A, B and q in the complementary load model.
- When the Swedish Complementary Load model is included, all 12 vehicles are selected by default. This means that the most onerous of the 12 will be identified so that the structural element under consideration can be “designed for the type vehicle that causes the most unfavourable influence” (EN1991-2 clause 4.2.1(1) Note 2). The number of vehicles selected for the optimisation may be reduced using the dialog provided, as appropriate to project requirements.
- It is noted that the Swedish complementary load model vehicles are identical to the “classification loads” of VV2009:61 Clause 2.3.2.2.1 (and Annex 2). However, for classification, VV2009:61 Clause 1.1.5.3 requires the engineer to calculate the maximum values of load magnitudes “A” and “B” that can be carried (also referring to VV2009:62 (MB803) for exceptional loads). Such a calculation is not automated, although values of A and B can be modified as described above.

Psi factors

Multi-component (ψ) factors are generally taken from EN1990 Table A2.1 since the note under VVFS 2009:19 Chapter 7, clause 5, Tabell A2.(S) states that “at least the recommended levels apply”. Infrequent values are not required (SIS/PAS NA, EN 1991-2:2003 clause 2.2(2)) and quasi-static values are not calculated since ψ_2 is given as zero for all traffic loads (EN1990 Table A2). Group 4 loading is not included in the calculation of Frequent values for the reason described under “Recommended Values”.

Multi-component (ψ) factors for the Swedish Complementary load model are taken from TK Bro VV2009:27 Clause B.2.1.2.2. Based on the values given (ψ_0 and ψ_1 but $\psi_2 = 0$), the complementary load model is included in the calculation of characteristic, combination and frequent values, but quasi-static values are not required.

Obtaining most onerous load patterns

The most onerous load patterns returned to the model after the optimisation process are based on a comparison of the Swedish complementary load model (using the selected type vehicles) and any other selected Eurocode load models (Group 1a, Group 4, Group 5). If it is desirable to view the most onerous of each load group, the check box on the Optional Code Settings Advanced dialog should be used.

Restrictions on use

The traffic load models in EN1991-2 are applicable for bridges with loaded lengths less than 200m (clause 4.1(1)). In general the use of Load Model 1 is conservative for loaded lengths over 200m (4.1(1) note 1). In TK Bro VV2009:27 clause B.3.4.1.3.(b) a load model for bridges of span >200m is given, However, this alternative Load model is not implemented. Calculation of the most onerous load pattern will proceed using the EN1991-2 load models and the Swedish Complementary load model, as selected, regardless of the loaded length and therefore patterns generated may be inappropriate for very long loaded lengths.

EN1991-2 Sweden 2011

Selecting **EN1991-2 Sweden 2011** sets default values for NDPs and offers traffic load options according to Swedish standard:

- **TRVFS2011:12 Updated rules for use of Eurocodes on highway projects (Trafikverket, Oct 2011))**

TRVFS2011:12 supersedes VV2009:19 for the implementation of highway traffic loading to the Eurocodes in Sweden. However, in fact the implementation is as described in “EN1991-2 Sweden 2009” above, except for the following modifications:

1. The Swedish complementary load model in TRVFS2011:12 Appendix 3 consists of 14 vehicles (type a to type n inclusive). Vehicle types a to l are as VV2009:19; vehicles type m and n, with fixed axle spacings, have been added.

2. The dynamic amplification factor in TRVFS2011:12 Chapter 6, clause 3 is set at a constant 20%. The default value reflects this change from the maximum of 35% in VV2009:19.
3. Multi-component (ψ) factors for the Swedish Complementary load model are given in TRVFS2011:12 Chapter 7, clause 5 (previously these were only found in TK Bro VV2009:27). However, values are identical in the two documents.

EN1991-2 Optional Code Settings - United Kingdom

This design code loading is supported by the LUSAS Traffic Load Optimisation software option.

Selecting **EN1991-2 UK 2009** on the main Vehicle Load Optimisation dialog sets default values for NDPs and offers traffic load options according to UK National Annexes published by BSI:

- **UK NA to BS EN1991-2:2003 incorporating corrigendum No 1 (May 2008)**
- **UK NA to BS EN 1990:2002+A1:2005 incorporating National Amendment No. 1 (June 2009)**

Undocumented entries

See [Eurocode EN1991-2 Optional Code Settings](#) for any dialog entries not covered in this topic.

Load model 1

Adjustment factors for Load Model 1 (α_Q , α_ψ) are taken from NA to BS EN1991-2 Table NA.1. According to EN1991-2 clause 4.3.2 (3) note 2, adjustment factors may correspond to classes of traffic. However, the adjustment factors in Table NA.1 are not dependent upon a selected traffic class and accordingly no traffic class options are offered on the dialog.

Load model 3

Load Model 3 special vehicles (three SV and four SOV model vehicles) are described in NA to BS EN1991-2 Fig NA.1 to NA.3 inclusive. One or more vehicles may be selected for use in the calculation of the most onerous load pattern. The selected vehicles are considered one at a time, being placed, together with associated Load Model 1 (switched on by default) according to the rules set out in clause NA.2.16.4.

Each SV has a central axle spacing which varies (3 possible values). All such axle spacings are considered in calculation of the most onerous load effect. Each SOV has an axle spacing which varies continuously from 1.5 to 40m. By default, this axle spacing is calculated to an accuracy set in the Optional Loading Parameters dialog.

Dynamic amplification factors (Table NA.2) are included in the calculation of the most onerous Group 5 load pattern and the wheel loads are accordingly factored within the vehicle (discrete point) loading attributes generated when the optimisation process is complete.

When Group 5 is included, the SV80 is selected as a default. This vehicle is intended to model the effects of STGO Category 2 vehicles with a maximum gross weight of 80 tonnes and a maximum basic axle load of 12.5 tonnes (NA.2.16.1.1). Project requirements would dictate if this is the appropriate vehicle and the vehicle selection may need to be adjusted or expanded.

According to EN1991-2 clause 4.2.1(1) Note 2, a complementary load model may be specified in the National Annex. No such complementary load model is described in the UK National Annex.

Psi factors

Multi-component (ψ) factors are taken from NA to BS EN1990 Table NA.A2.1. Infrequent values are not required (NA.2.3.6.2) and quasi-static values are not calculated since ψ_2 is given as zero for all traffic loads (Table NA.A2.1). Group 4 loading is not included in the calculation of Frequent values (note b to Table NA.A2.1).

Restrictions on use

The traffic load models in EN1991-2 are applicable for bridges with loaded lengths less than 200m (clause 4.1(1)). In general the use of Load Model 1 is safe-sided for loaded lengths over 200m (4.1(1) note 1). The UK National Annex states that Load Model 1 may be used for loaded lengths up to 1500m (NA to BS EN1991-2 clause NA2.6) and no information on load models appropriate beyond that length is given. Calculation of the most onerous load pattern will proceed regardless of the loaded length and therefore patterns generated may be inappropriate for very long loaded lengths.

Finland LO 24/2014 - Optional Code Settings

This design code loading is supported by the LUSAS Traffic Load Optimisation software option.

Selecting **Finland > LO 24/2014** on the main Vehicle Load Optimisation dialog sets default values for NDPs according to:

- **LO 24/2014 Application of the Eurocode - Bridge loads and design criteria - NCCI 1, Liikenneviraston (Finnish Transport Agency), Helsinki**

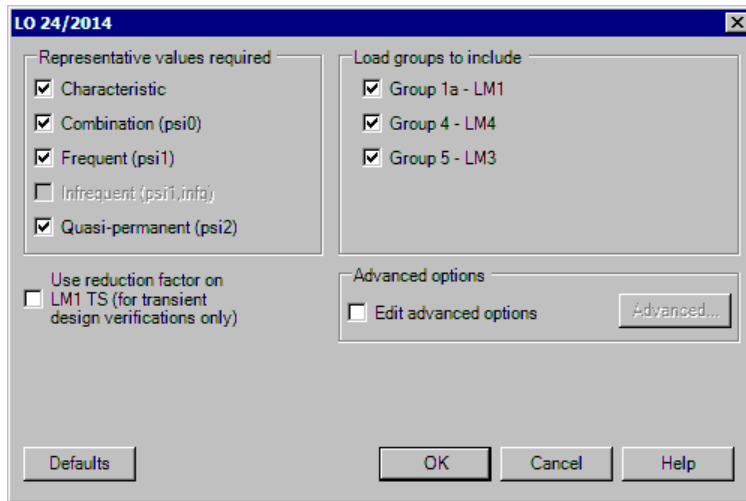

Undocumented entries

See [Eurocode EN1991-2 Optional Code Settings](#) for any dialog entries not covered in this topic.

Representative values required

- Infrequent (psi1, infq)** is not allowed for in this national annex.
- Quasi-permanent (psi2)** is enabled and checked by default, because this is required for this national annex.

Loads groups to include

There is no option to choose special vehicles for Group 5 – LM3.

Finland LO 24/2014 Optional Code Settings Advanced

The Optional Code Settings Advanced dialog is used to view and modify α_Q , α_q and ψ factors or parameters associated with national complementary load models (if applicable) and to request additional output.

Optional parameters

- Adjustment factors (α) for Load Model 1 UDL are in the format $\alpha_{q1}, \alpha_{q2}, \alpha_{q3}, \alpha_{qn}, \alpha_{qr}$.
- Adjustment factors for Load Model 1 Tandem System are in the format $\alpha_{Q1}, \alpha_{Q2}, \alpha_{Q3}$.
- Adjustment factors (ψ) for Load Model 1 UDL and Tandem System are in the format: $\psi_0, \psi_1, \psi_{1,infq}, \psi_2$
- Adjustment factor (ψ) for Load Model 4 is in the format: $\psi_{1,infq}$

The numerical subscripts in the above denote lane rank, starting with lane 1.

Defaults

The **Eurocode defaults** and the **Annex defaults** buttons permit the viewing of Recommended Values from EN1991-2 or the values stated in the National Annex selected on the main dialog (apart from when the “Recommended Values” option was selected from the main dialog).

Using the checkboxes factors may also be entered manually to suit project requirements. In some cases values may be modified to suit national requirements until a particular National Annex is fully implemented and available for those countries not currently supported.

Transit New Zealand Bridge Manual [SP/M/022 2nd Edition (2005), and 3rd Edition (2013)] Optional Settings

This design code loading is supported by the LUSAS Traffic Load Optimisation software option.

When using the country “New Zealand” and Design code “SP/M/022 2nd Edition (2005)” or SP/M/022 3rd Edition (2013), highway traffic loading is generated with reference to:

- **Bridge Manual SP/M/022 2nd Edition (June 2003, with amendments June 2004, September 2004, and July 2005), and 3rd Edition (May 2013)**

This document was originally published by Transit New Zealand, but since August 2008 it has been the responsibility of the New Zealand Transport Agency.

Note

Vehicle load optimisation to SP/M/022 as implemented in LUSAS TLO is restricted to vertical highway traffic loading and global effects. Fatigue loading, horizontal components, railway loads and pedestrian loads are not currently included. Accidental loads, as described in clause 3.2.3 (d), are considered to be for local effects and are not currently included.

Optional code settings dialog

The Optional Code Settings dialog allows selection of load models (components of HN-HO-72) required, as well as the setting of the dynamic factor. Factors and load intensities used in the calculations may be viewed and modified if required, by accessing the Advanced dialog.



Loading to consider

The traffic loads available on the dialog refer to SP/M/022 clauses 3.2.2 and 3.2.4 as follows:

- ❑ **HN (Normal) loading** As described in clause 3.2.2(a) and illustrated in Figure 3.1; this is formed from a uniformly distributed lane load spread over a 3m wide lane and placed in adverse areas, together with a pair of axle loads of 120kN each. The most onerous HN loading may comprise 1 or more loaded lanes, according to the reduction factors in clause 3.2.4.
- ❑ **HO (Overload) loading** As described in clause 3.2.2(b) and illustrated in Figure 3.1; this is formed from a uniformly distributed lane load spread over a 3m wide lane and placed in adverse areas, together with a pair of axle loads of 240kN each. The axles are considered as either a knife edge load (alternative (a)) or two wheel loads (alternative (b)). When used, HO loading replaces one element of HN loading in the traffic load pattern. The load pattern may include 1 or more loaded lanes, according to the reduction factors in clause 3.2.4.

The roadway is divided into a number of design lanes of equal width as per clause 3.2.3(b). Where this results in a lane width greater than 3m, the HN and HO loading will be placed in the most adverse transverse position.

The dialog allows selection of HN loading, HO loading or both. The most onerous traffic loading pattern appropriate to each selected load model will be determined, taking into account reduction factors as required. The dynamic factor will also be included if selected (see below).

Note

In SP/M/022 clause 3.5, normal traffic loads are denoted “LL” and overload combinations of traffic loads are denoted “OL”. LL and OL are considered in turn and always factored together in the combinations set out in Table 3.1 (Serviceability Limit State) and Table 3.2 (Ultimate Limit State). The load factors in Table 3.1 and 3.2 are not included in the optimised traffic loadcases, and therefore should normally be included in subsequent combinations.

Dynamic load factor

According to SP/M/022 clause 3.2.5 and Tables 3.1 and 3.2, both normal live load and overload shall be multiplied by a dynamic factor determined from Figure 3.2. The dialog allows the dynamic factor to be switched off if required, but more importantly allows the user to specify the value of that factor.

- The dynamic factor for components above ground and for bearings is 1.3 (default value) for most load effects. However for moments in simple or continuous beams of span the factor reduces for span lengths greater than 12m, to a minimum value of 1.19 at spans of 40m and above.

- The dynamic factor for below ground components is 1.0, to allow for vibration damping by the soil. However, for top slabs of culvert type structures the factor reduces linearly with depth of fill from 1.3 at zero fill to 1.0 at 1m fill.

A value (generally 1.3 or less) should be determined and entered into the dialog as required. In the instance where different dynamic factors are required within a bridge analysis, this can be handled by creating more than one Vehicle Load Optimisation analysis and using different settings as appropriate.

Advanced options

- ❑ **Edit advanced New Zealand options** - See [Transit New Zealand Bridge Manual \(SP/M/022 2nd and 3rd Edition\) Advanced Settings](#)

Transit New Zealand Bridge Manual (SP/M/022 2nd Edition (2005), and 3rd Edition (2013)) Advanced Settings

This dialog is used to view and modify reduction factors and load intensities.

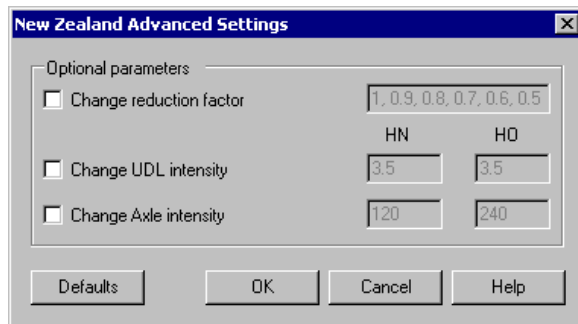

- ❑ **Change reduction factor** To allow for the improbability of concurrent loading, where appropriate, the total (traffic) loading is multiplied by a reduction factor, according to clause 3.2.4. Reduction factors are incorporated in the determination of the most onerous load pattern by default, but the values used may be modified by ticking this option and entering values appropriate to the number of elements of HN-HO-72 loading included (1 to 6 comma separated values, or more). To effectively eliminate reduction factors values of 1.0 may be entered for all 6 entries.
- ❑ **UDL intensity** A lane load UDL of 3.5kN/m² is used for both HN and HO loading, according to clause 3.2.2 and Figure 3.1.
- ❑ **Axle intensity** Total axle loads for HN and HO loading are 120kN and 240kN respectively, according to clause 3.2.2 and Figure 3.1.

Using the checkboxes, values for the UDL and Axle intensities may be entered manually under HN and/or HO as appropriate, to suit project requirements. The Default button resets all values back to the default values according to SP/M/022.

Saudia Arabia - MOMRA Optional Code Settings

This design code loading is supported by the LUSAS Traffic Load Optimisation software option.

When the country 'Saudi Arabia' and the Design code 'MOMRA', is selected on the main Vehicle Load Optimisation dialog, road traffic loading data and parameters can be specified with reference to MOMRA Bridges Design Specifications.

Scope

The scope of the vehicle load optimisation to MOMRA is restricted to vertical highway traffic loading and global effects. Horizontal components, railway loads and pedestrian loads are not currently included. The refined design truck for fatigue design of orthotropic decks, to Figure 3.6.1.4.1-1, is not included as it is considered applicable for local effects only.

The road carriageway is divided into standard 3.6m design lanes (apart from carriageways from 6.0m to 7.2m wide which have two equal width lanes). This will result in a “remaining width” for any carriageways of width not an integer multiple of 3,6m. The lanes are positioned laterally on the bridge to produce the most adverse effects, with the remaining width being placed either side of the lanes or between any of the lanes so as to produce the most onerous arrangement. The number of design lanes can be modified if required, as per MOMRA clause 3.6.1.1.1, via the [Advanced Settings](#) dialog. Loading moves transversely within the design lanes for most onerous effect.

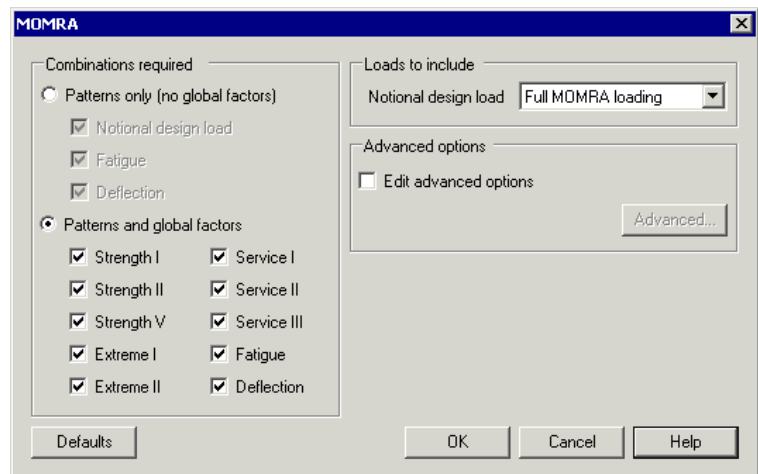

The Optional Code Settings dialog allows selection of the combinations and loads required. Factors used in the calculations and other settings may be viewed and modified if required, by accessing the [Advanced Settings](#) dialog.

Combinations required

Loading patterns are available either globally factored (i.e. with a Load Factor for a Limit State to MOMRA clause 3.4.1, or optionally edited in the [Advanced Settings](#) dialog) or unfactored as follows:

Patterns only (no global factors)

- **Notional design load** - loading to MOMRA clause 3.6.1.3.1
- **Strength II (Permit) unfactored** - as Notional design load pattern but with a Permit vehicle replacing one lane of loading, where this is more onerous
- **Fatigue** - loading to MOMRA clause 3.6.1.4.1
- **Deflection** - loading to MOMRA clause 3.6.1.3.2

Patterns and global factors

- Strength I / Strength V / Extreme I / Extreme II / Service I / Service II / Service III - as per Notional design load pattern but with the relevant global factor from MOMRA clause 3.4.1
- Strength II - as per Strength II (Permit) unfactored pattern but with the relevant global factor from MOMRA clause 3.4.1
- Fatigue - as per Fatigue pattern but with the relevant global factor from MOMRA clause 3.4.1
- Deflection - as per unfactored Deflection pattern but with the Service I global factor from MOMRA clause 3.4.1

The dialog allows selection of one or more combinations. The most onerous traffic loading pattern appropriate to each selected combination will be determined, with load factors included as appropriate.

Loads to include

- Notional design load.** If “Full MOMRA loading” is selected, the most onerous of the Design Truck or Design Tandem will be placed in each lane. If “Truck & lane loads only” or “Tandem & lane loads only” is selected, then the Design Truck or Design Tandem respectively will be placed in all lanes. This selection also affects the alternative loading for interior piers, i.e. the two truck loading and two tandem loading (for further details see [Advanced Settings](#) dialog).

Multiple presence factors are applied to the loading as per MOMRA clause 3.6.1.1.2, or optionally edited via the Advanced Settings dialog. The optimisation process takes

account of the multiple presence factors when calculating the most onerous load effect, such that every lane may not be loaded. As per clause 3.6.1.1.2 they are not applied to the Fatigue loading.

The dynamic load allowance to MOMRA clause 3.6.2.1 is applied to all vehicles in all combinations, but not to the design lane load. The values for All Other Components to Table 3.6.2.1-1 are applied by default; modifications are possible via the **Advanced Settings** dialog.

Two truck loading and two tandem loading for interior piers is included when the 'Alternative load pattern' option is selected on the Set Influence Surfaces dialog. (See also **Advanced Settings** dialog for further details on the two tandem loading).

A Defaults button is provided to reset all values back to those specified in MOMRA Bridges Design Specifications.

MOMRA Optional Code Settings (Advanced)

This dialog is used to view and modify dynamic factors, multiple presence factors, global factors and a number of additional settings.

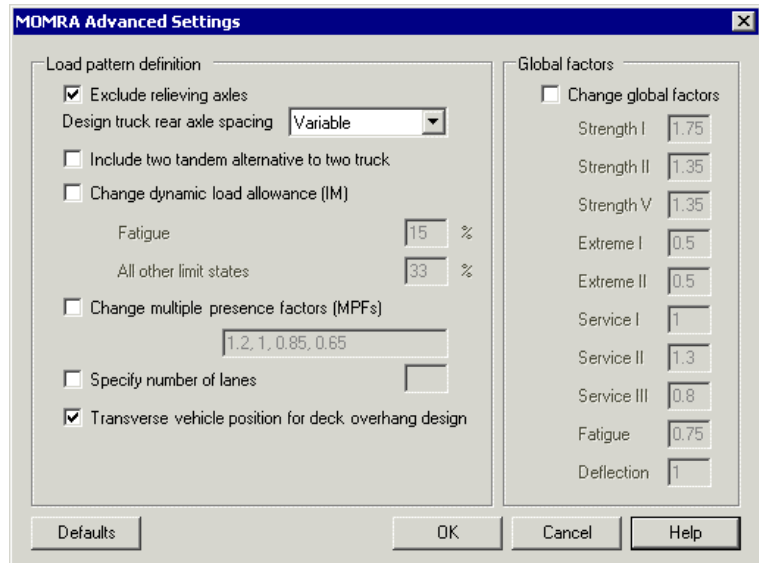

Load pattern definition

- Exclude relieving axles.** MOMRA clause 3.6.1.3.1 states “Axles that do not contribute to the extreme force effect under consideration shall be neglected.” By default relieving axles are therefore excluded from generated loading, but all vehicle axles may be included by unchecking this option.

- ❑ **Design truck rear axle spacing.** The Design Truck from MOMRA clause 3.6.1.2.2 has a rear axle which varies from 4.3m to 9.0m; this is implemented by default. This option gives the opportunity to restrict which axle spacings are considered in order to give a faster optimisation process. Axle spacing options should only be restricted when engineering judgement deems this will give a sufficiently accurate result. This option does not affect the axle spacing where it is specified elsewhere, i.e. two trucks (for interior piers) will still have a 4,3m rear axle to MOMRA clause 3.6.1.3.1 and for fatigue the truck will still have a 9.0m rear axle to MOMRA clause.
- ❑ **Include two tandem alternative to two truck.** This option allows the inclusion, to AASHTO LRFD commentary clause C3.6.1.3.1, of a two tandem alternative to the two truck loading. When selected it does not replace the two truck loading, rather it is an additional load, with the most onerous being selected. This option is unchecked by default.
- ❑ **Change dynamic load allowance (IM).** This option allows the modification of the IM from the values in MOMRA clause 3.6.2.1 for All Other Components, which are implemented as default values. Dynamic load allowance is applied to all vehicles in all combinations, but not to the design lane load.
- ❑ **Change multiple presence factors (MPFs).** This option allows the modification of the MPFs from the values in MOMRA clause 3.6.1.1.2, which are implemented as default values. The textbox has a comma separated list of four variables, applicable respectively to: one lane loaded, two lanes loaded, three lanes loaded, more than three lanes loaded.
- ❑ **Specify number of lanes.** By default the carriageway is divided into standard 3.6m design lanes, or two equal width lanes for carriageways from 6.0m to 7.2m wide, as per MOMRA clause 3.6.1.1.1. This option is provided in accordance with the same clause, allowing the number of design lanes to be specified if their width is less than 3.6m. If this option is selected the carriageway will be divided into the specified number of equal width lanes, although the lanes may not be less than 3.0m wide due to the width of the notional design loads.
- ❑ **Transverse vehicle position for deck overhang design.** As per MOMRA clause 3.6.1.3.1 the wheel loads should usually be restricted to 2ft from the edge of the design lane / curb, but should be allowed within 0.3m of the curb for the design of the deck overhang. By default the wheel loads are therefore restricted to 0.6m from the edge of the carriageway, but on selecting this option that distance is reduced to 0.3m

Global factors

- ❑ **Change global factors.** The default values provided to MOMRA clause 3.4.1 may optionally be edited. γ_{EQ} for Extreme I, which is to be determined on a project specific basis, has been assigned a default of 0.50. NB The default value for the factored Deflection combination is that for Service I, as per MOMRA clause 3.4.3.1, but may be edited to be different to that for Service I.

The value entered is only used for the factored Deflection combination and not for the unfactored combination.

- A **Defaults** button is provided to reset all values back to those specified in MOMRA.

South Africa - TMH7 Settings

This design code loading is supported by the Autoloader Vehicle Load Optimisation software option.

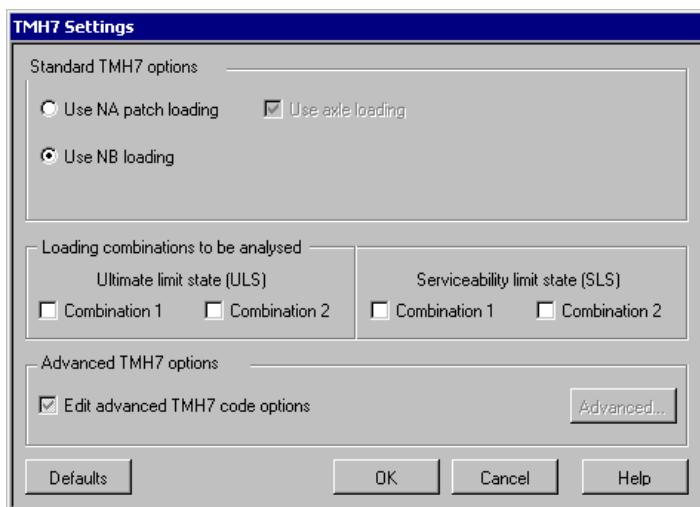

The following South African TMH7 options are available for selection:

- Use NA loading** - specifies whether to apply the NA loading (which includes axle loading).
- Use NB loading** - specifies whether to apply a single abnormal vehicle. If selected, the abnormal vehicles are applied to the carriageway. If not selected, then NA loading only is applied.
- Use axle loading** - specifies whether to apply axle loads. If selected, axle loads are applied to areas with NA loading, according to the standard in use. If not selected, no axle loads are applied. If **Use NA loading** is not selected then **Use axle loading** will not be enabled.
- Edit advanced TMH7 code options** - further to the basic code options provided on this dialog, Autoloader allows more advanced changes to the code to be made. To access this functionality ensure that the check box next to the label is selected and click on the Advanced button. Note, however, that it is unlikely that these advanced options will be required for the majority of work.

Notes

- Autoloader should be used for global bridge design. Local effects due to accidental wheel loads are not considered and so these effects should be assessed separately.
- The load sequence number is always assumed to be unity.
- The implementation of the South African loading code assumes that the transverse distribution has no significant effect and therefore the NA loading will be distributed over the full width of the notional lane.

TMH7 Advanced Settings

TMH7 Advanced Settings

Advanced TMH7 options

Use alternative vehicle to try in place of NA loading

File containing list of alternative vehicles: D:\ALUSAS145\Prog ... Vehicles: None

Change TMH7 partial load factors

SLS load factors: 1.0,1.0,1.0,1.0 ULS load factors: 1.5,1.3,1.2,1.1

Change TMH7 relationship between the carriageway width and the number of notional lanes

Lane width table: 4.8,7.4,2.0,7.4,11.1,3.0,11.1,14.8,4.0,14.8,18.5,5.0,18.5,22.4

Defaults OK Cancel Help

The following South African TMH7 advanced options are available for selection:

- Use alternative vehicle to try in place of NA loading** - defines a list of vehicles to be tried as an alternative to NA loading. When loading an NA lane, Autoloader tries to place vehicles from this list within the lane, and if the effect is greater than NA loading, uses that vehicle instead. Each vehicle must be specified in the Autoloader vehicle library.
- Change TMH7 partial load factors** - SLS Load factors allows specification of the partial load factors for the Serviceability Limit State and ULS Load factors allow specification of the partial load factors for the Ultimate Limit State. The list is ordered as follows:
 - NA alone (combination 1)
 - NA alone (combination 2)
 - NB with NA or NB alone (combination 1)

- NB with NA or NB alone (combination 2)
- Use TMH7 partial load factors** - SLS Load factors allows specification of the partial load factors for the Serviceability Limit State and ULS Load factors allow specification of the partial load factors for the Ultimate Limit State.
- Change TMH7 relationship between carriageway width and the number of notional lanes.** Each set of 3 values are taken as a lower limit, an upper limit and a number of notional lanes. After calculating the carriageway width Autoloader works its way down the table, checking the calculated width against the values in the table.

Sweden - TDOK 2013:0267 Military Vehicles Optional Code Settings

This design code loading is supported by the LUSAS Traffic Load Optimisation software option.

When country “Sweden” and Design code “TDOK 2013:0267 Military Vehicles” is selected on the main Vehicle Load Optimisation dialog, vehicle loading is generated to aid with military load classification of bridges with reference to clauses 2.2.1.5 and 1.3 of TDOK 2013:0267 Version 3.0 - Bärighetsberäkning av broar. UHabb January 2016.

The scope of the vehicle load optimisation to TDOK 2013:0267 is restricted to vertical military traffic loading and global effects. Horizontal components are not currently included.

The TDOK 2013:0267 Military Vehicles Settings dialog allows selection of the convoy type, vehicle loading type and MLC vehicle class(es) required. Factors used in the calculations may be viewed and modified if required, by accessing the [Advanced Settings](#) dialog.

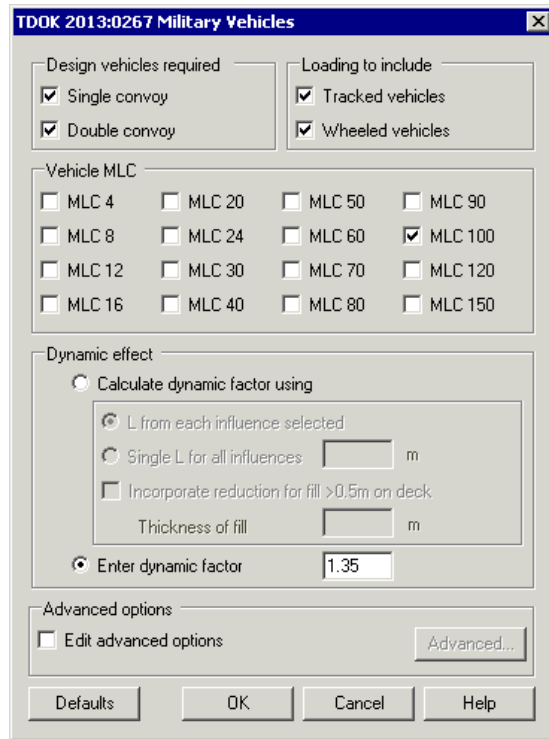

Design vehicles required

A **single convoy** (one way traffic), or a **double convoy** (two way traffic) can be considered, either in isolation or at the same time. On the loading dialog both are checked 'on' by default

For a double convoy there is currently no functionality within the LUSAS Traffic Load Optimisation facility that allows for the convoy loadings to move only in opposite directions. Instead the most onerous option of both convoys moving in the same direction across the structure or both convoys moving in the opposite direction across the structure is considered instead. This provides a conservative result.

Loading to include:

Tracked vehicles or wheeled vehicles can be considered, either in isolation, or at the same time. On the loading dialog both are checked 'on' by default.

Vehicle MLC

Sixteen Military Load Classification (MLC) options are available for selection, where the MLC class number corresponds to the mass of the tracked vehicle in short tons (0.90718474 of a metric tonne). At least one must be checked. MLC100 only is checked 'on' by default because it is the heaviest double convoy vehicle permitted.

Use of the double convoy option is not permitted for MLC 120 and MLC150, therefore when double convoy only is checked and single convoy is unchecked, MLC120 and MLC150 checkboxes are disabled.

If the width of the carriageway is outside the limits for the vehicles selected according to TDOK 2013-0267, table 2-4, a warning is produced. If, at runtime, the vehicles do not physically fit in the carriageway, they will not be placed, and a warning message will be given.

Dynamic effect

All loads placed on the bridge will include a dynamic factor, which can be specified by either of the following options:

Calculate dynamic factor using

- **L from each influence selected.** If this radio button is checked, it will be necessary to introduce the length (L) for every influence in the influence dialog.
- **Single L for all influences.** If this radio button is checked, the text box will be enabled and the value of the length will have to be defined.
- **Incorporate reduction for fill >0.5m on deck.** If this checkbox is checked, the text box will be enabled and the thickness of fill must be defined. The value of the dynamic factor will be reduced accordingly in accordance with TDOK 2013-0267, clause 9.2.1.1.1.3.

Enter dynamic factor: Allows entering a dynamic factor manually. Set to 1.35 by default.

A Defaults button is provided to reset all checkboxes and values back to those initially supplied.

Sweden - TDOK 2013:0267 Military Vehicles Advanced Settings

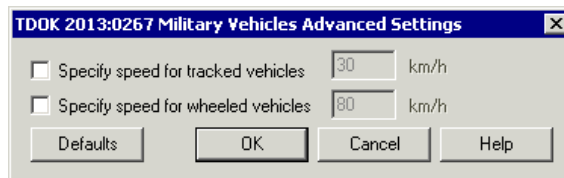

These check box options are used to calculate the dynamic factor for tracked and wheeled vehicles respectively if the radio button “Calculate dynamic factor using” in the Code Settings Dialog is checked.

Specify speed for tracked vehicles

Specify speed for wheeled vehicles

A Defaults button is provided to reset all checkboxes and values back to those initially supplied.

United Kingdom - BA34/90 Settings

This design code loading is supported by the LUSAS Traffic Load Optimisation software option.

When using the country “UK” and Design code “BA34/90”, road traffic loading is generated to BA34/90, with reference to BD21/01 and BD37/01.

The scope of the vehicle load optimisation to BA34/90 is restricted to vertical highway traffic loading and global effects. Horizontal components and pedestrian loads are not currently included.

The Optional Code Settings dialog allows selection of the combinations and loads required. Factors used in the calculations may be viewed and modified if required, by accessing the [Advanced Settings](#) dialog.

The screenshot shows the 'BA34/90' dialog box with the following settings:

- Combinations required:**
 - ULS Combination 1
 - ULS Combinations 2 and 3
 - SLS Combination 1
 - SLS Combinations 2 and 3
- Number of notional lanes:**
 - From table
 - From traffic lane markings
 - Number of lanes in each carriageway:
- Advanced options:**
 - Edit advanced options
 - Advanced... button
- Loading to include:**
 - Type HB loading
 - ULS: Units SLS: Units
 - Associated ALL: (dropdown)
 - Treat as transverse spanning
 - Additional HB vehicle: Units
- Exceptional vehicle(s):**
 - Include at ULS
 - Include at SLS
 - Vehicles: (dropdown)
 - Associated ALL: (dropdown)
- Assessment Live Loading (ALL):**
 - Allow ALL-only load patterns
 - Assessment load level: (dropdown)
 - Road surface: (dropdown)
 - Traffic flow: (dropdown)
 - Include KEL loads
 - Adjust base length at cusps

Buttons at the bottom: Defaults, OK, Cancel, Help

Combinations required

The combinations available on the dialog refer to those from BD37/01, as referenced by BA34/90 clause 3.2. As the partial load factors in ULS combinations differ between different loads, it is necessary for the factors to be considered as part of the optimisation process. The limit states and combinations are taken from BD37/01 Clause 4.4 and Table 1.

Number of notional lanes

- From table** The road carriageway is by default divided into a number of equal width lanes as per BD21/01 Table 5.1. This table has a limit of 21.9m, with 6 lanes. This option is hence not compatible with wider carriageways.
- From traffic lane marking** This option allows the input of the number of lanes as per BD21/01 clause 5.6. If multiple carriageways are selected, this number is used for them all.

It is interpreted in VLO that all lanes will have an equal width, equal to the carriageway width divided by the provided number of lanes. Unequal lane widths (if required) can be achieved by defining each lane as a separate carriageway and using the “From table” option.

Loading options

- Type HB loading** HB loading is provided to BD37/01 Clause 6.3. Units of ULS and SLS can be specified independently via check boxes. Application with ALL is in accordance with BD37/01 Clause 6.4.2, with ALL taken to replace Type HA loading. The selection of the option to Treat as transverse spanning generates loading to Clause 6.4.3.1. An option is provided for the Associated ALL, allowing the inclusion of ALL in all lanes, only lanes which do not contain the HB vehicle, or the exclusion of ALL.
- Exceptional vehicles** Vehicles are provided to the highways Agency’s Heavy Load Vehicle Classification Specifications. Application with ALL is in accordance with BD37/01 Clause 6.4.2, with ALL taken to replace Type HA loading and Exceptional vehicles taken to replace Type HB loading. An option is provided for the Associated ALL, allowing the inclusion of ALL in all lanes, only lanes which do not contain the Exceptional vehicle, or the exclusion of ALL.

Assessment Live Loading (ALL)

ALL is provided to BD21/01. The reduction factor is provided to Figures 5.2 to 5.7 based on selections made for Assessment load level, Road surface and Traffic flow.

For more detail on interpretations made for ALL, see [BD21/01 Optional Settings](#).

- Allow ALL-only load patterns.** By default an ALL only pattern is included, with ULS load factors to BD37/01 Table 1. This checks against the case where Type HA alone, with a high partial factor, is more onerous than an HB/Exceptional vehicle with ALL at lower partial factors. This loading option

may be optionally disabled, but note that this only removes the load pattern with higher factors; if ALL with lower partial factors is still more onerous than the HB/Exceptional vehicle then the optimisation will not place the HB/Exceptional vehicle on the deck.

- Include KEL loads.** By default, one KEL is included per lane. This may be optionally disabled.
- Adjust base length at cusps.** As required by BD37/01 note to Table 13, “where the influence line has a cusped profile and lies wholly within a triangle joining the extremities of its base to its maximum ordinate, the base length shall be taken as twice the area under the influence line divided by the maximum ordinate”. This may be optionally disabled.

A Defaults button is provided to reset all values back to those specified in the design codes.

United Kingdom - BA34/90 Advanced Settings

	HB and associated ALL	Exceptional vehicle(s) and associated ALL	ALL alone
ULS Combination 1	1.3	1.3	1.5
ULS Combinations 2 and 3	1.1	1.1	1.25
SLS Combination 1	1.1	1.1	1.2
SLS Combinations 2 and 3	1	1	1

This dialog is used to view and modify lane factors and partial load factors.

Optional parameters

- Change lane factors** This option allows the modification of the lane factors from the values in BD21/01 clause 5.24, which are implemented as default values. The textbox has a comma separated list of four variables, applicable respectively to: Lane 1, Lane 2, Lane 3, Lane 4 and subsequent.
- Change partial load factors (yfl)** This option allows the modification of the partial load factors from the values in BD37/01 Table1, which are implemented as default values. Exceptional vehicles (and their associated ALL) are assigned the same factors as for HB vehicles by default.

A Defaults button is provided to reset the values back to those specified in the design codes.

United Kingdom - BA34/90 Implementation Notes

With reference to:

- Design Manual for Roads and Bridges, Volume 3, Section 4, Part 17: BD34/90 Technical Requirements For The Assessment And Strengthening Programme For Highway Structures, last updated Sept 1990
- Design Manual for Roads and Bridges, Volume 3, Section 4, Part 17: BA34/90 Technical Requirements For The Assessment And Strengthening Programme For Highway Structures, last updated Sept 1990
- Heavy Load Vehicle Classification Specifications (Highways Agency, Dec 2006)

Existing UK highway bridges which are shown to be adequate to support 40t Assessment Live Loading may then be assessed for their capacity with respect to Special Types General Order (STGO) vehicles (see BD21/01 clause 5.12). The current Code Of Practice for such assessment is BD86/11, which is also available in the LUSAS Vehicle Load Optimiser.

Prior to 2001, STGO ratings were assessed using HB vehicles to BD34/90. Such ratings are still widely used by highway authorities. BD34/90 makes only the broadest statements about which structures should be assessed using HB vehicles; clause 1.4 refers us to BA34/90 for details, although BD34/90 clause 3.1 (g) (ii) does allow for the assessment of bridges for their capacity to carry specific exceptional vehicles. The LUSAS Traffic Load Optimisation software accordingly includes options for specific vehicles to the Heavy Load Vehicle Classification Specifications.

BA34/90 refers to superseded standards BD21/84 and BD37/88 which have been read as BD21/01 and BD37/01 respectively. In essence, the Assessment Live Loading of BD21/01 is applied together with HB vehicles in patterns and combinations complying with the requirements of BD37/01. The BD21/01 Code is available in the LUSAS Vehicle Load Optimiser; more details about its loading requirements may be found in the appropriate Help entry.

It may be of interest to the highway authority to consider what HB rating or what exceptional vehicles may be safely transported if specific traffic restrictions are in place, for example, if a temporary 3t limit is placed on the bridge during the transit of an exceptional vehicle; if all other vehicular loads are excluded from the bridge; or if all other loads are restricted from the lane carrying the abnormal vehicle; therefore the options for associated live load allow user selection of the loading level required (40t, 26t, 18t, Group 1 FE, 7.5t, Group 2 FE, 3t), road surface category (good, poor) and traffic flow (high, medium, low) as appropriate.

It may also be of interest to the Highway Authority to consider what HB rating or what exceptional vehicles may be safely transported if all other vehicular loads are excluded

from the bridge; or if all other loads are excluded from the lane(s) occupied by the abnormal vehicle.

BA34/90 Optional Settings and **BA34/90 Advanced Settings** give further clarification on certain clauses of BA34/90 and their implementation within the LUSAS Traffic Load Optimisation software and information on all available options.

United Kingdom - BD21/01 Optional Code Settings

This design code loading is supported by the LUSAS Traffic Load Optimisation software option.

When country “UK” and Design code “BD21/01” is selected on the main Vehicle Load Optimisation dialog, road traffic loading is generated with reference to BD21/01 Section 5.

The scope of the vehicle load optimisation to BD21/01 is restricted to vertical highway traffic loading and global effects. Horizontal components and pedestrian loads are not currently included.

The Optional Code Settings dialog allows selection of the combinations and loads required. Factors used in the calculations may be viewed and modified if required, by accessing the Advanced Settings dialog.

The screenshot shows the 'BD21/01' dialog box with the following settings:

- Results required:**
 - Provide unfactored load patterns
 - Include partial load factor γ_{fl} 1.5
 - Assessment load level: 40 tonnes
 - Road surface poor
 - Traffic flow high
 - Traffic flow medium
 - Traffic flow low
 - Road surface good
 - Traffic flow high
 - Traffic flow medium
 - Traffic flow low
- Loading options:**
 - Include KEL loads
 - Adjust base length at cusps
- Number of notional lanes:**
 - From table
 - From traffic lane markings
 - Number of lanes in each carriageway: []
- Advanced options:**
 - Edit advanced options
 - Advanced...

Results required

- Provide unfactored load patterns** Loading patterns are available either unfactored, or globally factored (i.e. with a partial factor). The default is factored for “Other Structures” to BD21/01 Table 3.1

- Assessment load level** All Assessment load levels from BD21/01 Figures 5.2 to 5.7 are available.
- Road surface poor / Road surface good** Three traffic flow rates are available, allowing selection of one or more of these categories. The most onerous traffic loading pattern appropriate to each selected category will be determined.

Note. As per Note to BD21/01 clause 5.27, these categories are not used if the assessment load level selected is Group 1 FE, Group 2 FE or 3 tonnes.

Loading options

- Include KEL loads** By default, one KEL is included per lane. This may be optionally disabled.
- Adjust base length at cusps** As required by BD37/01 note to Table 13, “where the influence line has a cusped profile and lies wholly within a triangle joining the extremities of its base to its maximum ordinate, the base length shall be taken as twice the area under the influence line divided by the maximum ordinate”. This may be optionally disabled.

Number of notional lanes

- From table** The road carriageway is by default divided into a number of equal width lanes as per BD21/01 Table 5.1. This table has a limit of 21.9m, with 6 lanes. This option is hence not compatible with wider carriageways.
- From traffic lane markings** This option allows the input of the number of lanes as per BD21/01 clause 5.6. If multiple carriageways are selected, this number is used for them all.

It is interpreted in VLO that all lanes will have an equal width, equal to the carriageway width divided by the provided number of lanes. Unequal lane widths (if required) can be achieved by defining each lane as a separate carriageway and using the “From table” option.

A Defaults button is provided to reset all values back to those specified in BD21/01.

United Kingdom - BD21/01 Advanced Settings

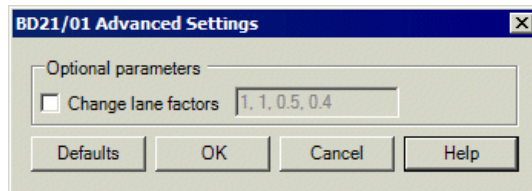

The following BD 21/01 advanced options are available for selection:

Optional parameters

- Change lane factors** This option allows the modification of the lane factors from the values in BD21/01 clause 5.24, which are implemented as default

values. The textbox has a comma separated list of four variables, applicable respectively to: Lane 1, Lane 2, Lane 3, Lane 4 and subsequent.

A Defaults button is provided to reset the values back to those specified in BD21/01.

United Kingdom - BD21/01 Implementation Notes

Design Manual for Roads and Bridges Vol 3, Section 4, Part 3: BD21/01 The Assessment of Highway Bridges and Structures, last amended Aug 2001. Available freely from www.standardsforhighways.co.uk

BD21/01 Assessment Live Loading comprises Type HA loading UDL and KEL. The load intensities in clause 5.18 are similar to those in BD37/01, multiplied by a reduction factor (K), which varies according to loaded length and

- Good/poor surfacing
- High/medium/low traffic flow
- Load level, being 40 tonnes, 26 tonnes, 18 tonnes, Group 1 FE, 7.5 tonnes, Group 2 FE or 3 tonnes

The three traffic categories, two surfacing categories and seven load levels are represented by the 27 K factor/loaded length curves in BD21/01 Figures 5.2 to 5.7 (Note that as per Clause 5.27 the curves for the 3 tonne and fire engine loading models do not vary between the figures). The load intensities are further multiplied by lane factors (clause 5.24) and divided by an Adjustment Factor (clause 5.23). The loading is applied over a 2.5m width within each notional lane as appropriate. Details of notional lanes are given in clause 5.6. A partial factor for loads may be applied to live loads as per Table 3.1.

The user interface allows the study of several road surface and traffic flow conditions in a single use of the traffic load optimiser. This is to enable the assessing engineer to understand how sensitive the results of the analysis are to such assumptions.

Bridges which are shown to be adequate to support the uppermost (40 tonnes) assessment loading level may then be assessed for their capacity with respect to Special Types General Order (STGO) vehicles (see BD21/01 clause 5.12). This is currently carried out using SV/SOV vehicles to BD86/11; prior to 2001 such ratings were assessed using HB vehicles to BA34/90. Both Codes Of Practice are also available in the LUSAS traffic load optimiser.

The notes below give further clarification on certain clauses of BD21/01 and their implementation within the LUSAS traffic load optimiser, and information on available options.

Positioning of UDL and KEL

BD21/01 clause 5.26 states “The lane loading for any lane determined as in 5.25 above shall be applied to occupy a width of 2.5m, in the most onerous transverse position in that lane.” This is interpreted to mean that the UDL and KEL occupy the same transverse position in each lane. The vehicle load optimiser allows this combined UDL and KEL to occupy the most adverse transverse position within the lane.

BD21/01 clause 5.18 states that the KEL is “uniformly distributed across the lane width”. This is interpreted to mean that the KEL may only be positioned perpendicular to the direction of the lane.

Loaded lengths less than 2m

BD21/01 clause 5.9 requires that for “loaded lengths less than 2m the single axle load and the single wheel load shall be used”. These loads are not implemented in VLO as they are local effects. Loaded lengths less than 2m are therefore treated the same as loaded lengths from 2m to 50m.

loaded lengths greater than 50m and use of BD50/92

BD21/01 clause 5.9 states “For loaded lengths in excess of 50m, the UDL and KEL to be used shall be as described in BD 50 (DMRB 3.4.2).” BD50/92 has been withdrawn from the DMRB, with the Highways Agency website stating “Users seeking BD50/92 should refer to BD101/11”. BD101/11, however, does not discuss the use of UDL or KEL for loaded lengths in excess of 50m. The use of the withdrawn BD50/92 is therefore considered to still be valid (for the specific purpose of loaded lengths in excess of 50m only) and is therefore implemented by the vehicle load optimiser.

The unfactored HA UDL intensity for adverse lengths up to 50m are defined by BD21/01 Clause 5.18; identical to the corresponding BD37/01 clause 6.2.1 (first expression). For lengths greater than 50m, BD21/01 Clause 5.18 refers to BD50/92, where Clause 2.3 refers in turn to BD37/01 - where the UDL for loaded lengths over 50m is defined in Clause 6.2.1 by the second expression, and this is used within the vehicle load optimiser.

For loaded lengths below 50m, BD21/01 specifies an Adjustment Factor AF. AF is not specified in BD50/92 for loaded lengths greater than 50m, but given that in BD21/01 it increases with loaded length to a maximum of 1.0 (for 40m to 50m), it has been taken as 1.0 for loaded lengths in excess of 50m within the vehicle load optimiser.

BD50/92 Clause 2.3 defines the K factor for loaded lengths greater than 50m as 0.91 for 40t and 0.4 for 7.5t, without defining the Traffic and Surface they relate to, or K Factors for the other Assessment Load Levels. BD21/01 Figures 5.2 to 5.7 give K factor for 40t for High_poor as 0.91 for all lengths up to 50m. It is therefore considered that the 0.91 factor in BD50/92 is applicable for 40t High_poor, and hence for 40t, 26t, 18t and Group 1 FE (all of which have uniform or near uniform K factors approaching 50m), the K factor for Loaded Lengths in excess of 50m can be taken as that for 50m in Figures 5.2 to 5.7. For 7.5t, Group 2 FE and 3t (all of which have a K

factor increasing towards 50m with a value of 0.35 at 50m) it is considered that the K factor can be taken as 0.4 for all loaded lengths in excess of 50m.

United Kingdom - BD21/01 Annexes D and E Optional Code Settings

This design code loading is supported by the LUSAS Traffic Load Optimisation software option.

When country “UK” and Design code “BD21/01 Annexes D and E ” is selected on the main Vehicle Load Optimisation dialog, road traffic loading is generated with reference to:

- **BD21/01 The Assessment Of Highway Bridges And Structures Design Manual for Roads and Bridges, Volume 3, Section 4, Part 3, Highways Agency, May 2001**

The scope of the vehicle load optimisation to BD21/01 is restricted to vertical highway traffic loading and global effects. Horizontal components and pedestrian loads are not currently included.

The Optional Code Settings dialog allows selection of the combinations and loads required. Factors used in the calculations may be viewed and modified if required, by accessing the Advanced Settings dialog.

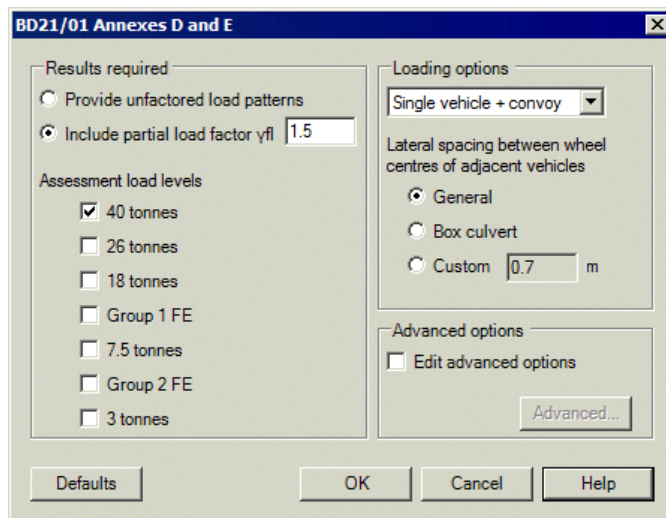

Results required

- Provide unfactored load patterns** Loading patterns are available either unfactored, or globally factored (i.e. with a partial factor). The default is factored for “Other Structures” to BD21/01 Table 3.1
- Assessment load level** All Assessment load levels from BD21/01 are available. By default only “40 tonnes” is checked.

Loading options

- Single vehicle and convoy** (default option). Other options are 'Single vehicle only' and 'Convoy only'.
- Lateral spacing between wheel centres of adjacent vehicles** provides three options to specify the lateral spacing between wheel centres of adjacent vehicles in accordance with BD21/01 The Assessment Of Highway Bridges And Structures Design Manual for Roads and Bridges, Volume 3, Section 4, Part 3. Annex D clause D3
 - **General** specifies a lateral spacing distance of 0.7m. Selection of this option applies an impact factor to all vehicles in all lanes.
 - **Box culvert** specifies a lateral spacing distance of 1.5m. Selection of this option applies an impact factor to one vehicle in one lane.
 - **Custom.** allows any lateral spacing distance to be specified. Selection of this option applies an impact factor to all vehicles in all lanes.

A Defaults button is provided to reset all values back to those specified in BD21/01.

United Kingdom - BD21/01 Annexes D and E Implementation Notes

In accordance with the code each wheel should be ignored independently if it has a relieving effect; however, as implemented, the wheels in an axle will be ignored only if the whole axle has a relieving effect.

For load patterns (Group 1 FE Convoy LP and Group 2 FE Convoy LP), which include fire engines and RG – 3 tonnes vehicles, a minimum distance between vehicles has been introduced for the whole load pattern. Thus it is not possible to specify a different value for the fire engines and for the RG – tonnes vehicles.

In the case of a box culvert with the option 'Custom' (for lateral spacing different than 1.5m) the impact factor will be applied to vehicles of all lanes instead of to the vehicle of the one lane only, that is, for the purpose of the impact factor, the option 'Custom' is the same as the option 'General'.

United Kingdom - BD37/01 Optional Code Settings

This design code loading is supported by the LUSAS Traffic Load Optimisation software option.

When country “UK” and Design code “BD37/01” is selected on the main Vehicle Load Optimisation dialog, road traffic loading is generated with reference to BD37/01.

The scope of the vehicle load optimisation to BD37/01 is restricted to vertical highway traffic loading and global effects. Horizontal components and pedestrian loads are not currently included.

The Optional Code Settings dialog allows selection of the combinations and loads required. Factors used in the calculations may be viewed and modified if required, by accessing the [Advanced Settings](#) dialog.

The screenshot shows the 'BD37/01' dialog box with the following settings:

- Combinations required:**
 - ULS Combination 1
 - ULS Combinations 2 and 3
 - SLS Combination 1
 - SLS Combinations 2 and 3
- Number of notional lanes:**
 - From table
 - From traffic lane markings
 - Number of lanes in each carriageway:
- Advanced options:**
 - Edit advanced options
 -
- Loading to include:**
 - Type HA loading:**
 - Include at ULS
 - Include at SLS
 - Include KEL loads
 - Adjust base length at cusps
 - Type HB loading:**
 - Include at ULS: Units
 - Include at SLS: Units
 - Associated Type HA:
 - Treat as transverse spanning
 - Additional HB vehicle: Units
- Exceptional vehicle(s):**
 - Include at ULS
 - Include at SLS
 - Vehicles:
 - Associated Type HA:

- Buttons:** Defaults, OK, Cancel, Help

Combinations required

The combinations available on the dialog refer to those from BD37/01 Table 1 which contain highway bridges live loading. As the partial load factors in ULS combinations differ between different loads, it is necessary for the factors to be considered as part of the optimisation process.

Number of notional lanes

- ❑ **From table** The road carriageway is by default divided into a number of equal width lanes as per BD37/01 Clause 3.2.9.3. This table has a limit of 21.9m, with 6 lanes. This option is hence not compatible with wider carriageways.
- ❑ **From traffic lane markings.** This option allows the input of the number of lanes. If multiple carriageways are selected, this number is used for them all.

It is interpreted in VLO that all lanes will have an equal width, equal to the carriageway width divided by the provided number of lanes. Unequal lane widths (if required) can be achieved by defining each lane as a separate carriageway and using the “From table” option, although this will prevent HB and exceptional vehicles straddling lanes.

Loading options

- ❑ **Type HA loading** HA loading is provided to BD37/01 clause 6.2.
 - **Include at ULS/SLS** These options will include HA-only load patterns, to BD37/01 clause 6.4.1.
 - **Include KEL loads** By default, one KEL is included per lane. This may be optionally disabled.
 - **Adjust base length at cusps** As required by BD37/01 note to Table 13, “where the influence line has a cusped profile and lies wholly within a triangle joining the extremities of its base to its maximum ordinate, the base length shall be taken as twice the area under the influence line divided by the maximum ordinate”. This may be optionally disabled.
- ❑ **Type HB loading** HB loading is provided to BD37/01 Clause 6.3. Application with Type HA is in accordance with BD37/01 Clause 6.4.2. The selection of the option to 'Treat as transverse spanning' generates loading to Clause 6.4.3.1 instead. An option is provided for the 'Associated Type HA', allowing the inclusion of HA in all lanes, only lanes which do not contain the HB vehicle, or the exclusion of HA.
- ❑ **Exceptional vehicles.** Vehicles are provided to the Highways Agency’s Heavy Load Vehicle Classification Specifications. Application with Type HA is in accordance with BD37/01 Clause 6.4.2, with Exceptional vehicles taken to replace Type HB loading. An option is provided for the 'Associated Type HA', allowing the inclusion of HA in all lanes, only lanes which do not contain the Exceptional vehicle, or the exclusion of HA.

A Defaults button is provided to reset all values back to those specified in the design codes.

The remaining area load as implemented is 5kN/m2. See implementation notes.

United Kingdom - BD37/01 Advanced Settings

	HA alone	HB and associated HA	Exceptional vehicle(s) and associated HA
ULS Combination 1	1.5	1.3	1.3
ULS Combinations 2 and 3	1.25	1.1	1.1
SLS Combination 1	1.2	1.1	1.1
SLS Combinations 2 and 3	1	1	1

This dialog is used to view and modify lane factors and partial load factors.

Optional parameters

- Fix lane factors.** By default the varying lane factors in BD37/01 Table 14 are used; the factor for each lane varies depending on the lane width, loaded length, and number of lanes. This option allows the modification of the lane factors to fixed (non-varying) values. The textbox has a comma separated list of four variables, applicable respectively to: Lane 1, Lane 2, Lane 3, Lane 4 and subsequent.
- Change HA UDL loading curve.** By default the equations in BD37/01 Clause 6.2.1 are used. This option allows the specification of an alternative loading curve as a piecewise linear curve.
- Change partial load factors (γ_{fl}).** This option allows the modification of the partial load factors from the values in BD37/01 Table 1, which are implemented as default values. Exceptional vehicles (and associated HA) are assigned the same factors as for HB vehicles by default.

A Defaults button is provided to reset the values back to those specified in the design codes.

United Kingdom - BD37/01 Implementation Notes

With reference to:

- Design Manual for Roads and Bridges, Volume 1, Section 3, Part 14: BD37/01 Loads For Highway Bridges, last updated May 2002
- Heavy Load Vehicle Classification Specifications (Highways Agency, Dec 2006)

Since 31 March 2010, the Highways Agency has specified the design of highway structures on the trunk road network in terms of Eurocodes. Prior to that date, the loading standard specified by the Highways Agency was BD37/01.

It may be of interest to the highway authority to design for an HB or Exceptional Vehicle with all other vehicular loads are excluded from the bridge, or with all other loads restricted from the lane(s) occupied by the abnormal vehicle; therefore the options for associated live load allow user selection of these situations.

The notes below give further clarification on certain clauses of BD37/01 and their implementation within the LUSAS traffic load optimiser, and information on all available options.

- ❑ **Partial factor γ_{F3}** , although mentioned in Clause 4.1.3 has not been included. This is as it is handled differently in different design codes (BS5400-3 clause 4.3.2, BS 5400-4 clause 4.2 and BS5400-5 clause 4.1.4), its value is not given in BD37/01, and it does not affect the generation of loading patterns.
- ❑ **Knife Edge Load (KEL)** Clause 6.4.1.5 indicates that the KEL may act in various directions in differing situations. The traffic load optimiser is a tool intended for global analyses and the KEL is always placed perpendicular to the lane direction.
- ❑ **Transverse spanning slabs** Clause 6.4.3.1 requires the consideration of two situations: either an HB vehicle occupying any position; or an HB vehicle in a notional lane with a 30unit HB vehicle in another notional lane. For the majority of lane widths this second situation would not be considered using lane widths to Clause 3.2.9.3.1, as this clause normally produces lanes too narrow to contain an HB vehicle (i.e. lanes less than 3.5m). In order to implement the second situation, the carriageway is divided such that there are the maximum possible number of lanes of 3.5m minimum width, such that HB vehicles can be accommodated.
- ❑ **Exceptional Vehicles** Clause 5.7.2 allows the consideration of Abnormal Indivisible Loads. For Highways Agency schemes the loads in “High and Heavy Load Grids - January 2007” (HHLG) are sometimes required, and hence have been implemented for BD37/01.

HHLG contains Tables and Drawings. The loads and spacings are not all consistent between the Tables and the Drawings. Where they differ, the values from the Tables have been implemented. The layout of the Tractors with respect to the Trailers also differs between the Tables and the Drawings; all variations in both the Tables and the Drawings have been implemented.

HHLG does not specify the overall width of the vehicles. This affects how close loads get to carriageway edges, and also at what position they displace HA loading to Clause 6.4.2 (displacement rules implemented as identical to those for HB). The width has therefore been taken as 3.5m, the same as for HB vehicles.

Loading of remaining area

BD37/01 Clause 6.4.1.1 states "The loading on the remainder of the carriageway width shall be taken as 5kN/m", i.e. 5kN per linear metre. However, BD37/88 and BS5400-2:2006 both state, also in Clause 6.4.1.1: "The loading on the remainder of the carriageway width shall be taken as 5kN/m²", i.e. 5kN per square metre. It is believed that this constitutes a typographical error in BD37/01, so for both BD37/01 and BS5400-2:2006, the remaining area load as implemented is 5kN/m². For areas of width >1m, this interpretation is conservative in any case, for areas of width <1m the reduction in loading is likely to be small by comparison to the assumptions made for loading on the bridge as a whole.

United Kingdom - BD86/11 Optional Code Settings

This design code loading is supported by the LUSAS Traffic Load Optimisation software option.

When using the country "UK" and Design code "BD86/11", road traffic loading is generated to BD86/11, with reference to BD21/01 and BD37/01.

The scope of the vehicle load optimisation to BD86/11 is restricted to vertical highway traffic loading and global effects. Horizontal components and pedestrian loads are not currently included.

The Optional Code Settings dialog allows selection of the combinations and loads required. Factors used in the calculations may be viewed and modified if required, by accessing the [Advanced Settings](#) dialog.

The screenshot shows the 'BD86/11' dialog box with the following settings:

- Combinations required:**
 - Ultimate Limit State (ULS)
 - ULS Combination 1
 - ULS Combinations 2 and 3
 - Nominal loads only
 - SLS (and cast iron bridges)
- Number of notional lanes:**
 - From table
 - From traffic lane markings
 - Number of lanes in each carriageway:
- Advanced options:**
 - Edit advanced options
 -
- Load models to consider:**
 - Special vehicles
 - Vehicle(s): ...
 - Speed of transit:
 - Associated Type HA loading:
 - Associated Type HA loading
 - Assessment load level:
 - Road surface:
 - Traffic flow:
 - Include KEL loads
 - Adjust base length at cusps
 - Allow HA-only load patterns

Buttons at the bottom: Defaults, OK, Cancel, Help.

Combinations required

The combinations available on the dialog cover all situations from BD86/11 clauses 2.6 to 2.9. As the partial load factors in ULS combinations differ between different loads, it is necessary for the factors to be considered as part of the optimisation process.

Number of notional lanes

- From table** The road carriageway is by default divided into a number of equal width lanes as per BD21/01 Table 5.1. This table has a limit of 21.9m, with 6 lanes. This option is hence not compatible with wider carriageways.
- From traffic lane markings** This option allows the input of the number of lanes as per BD21/01 clause 5.6. If multiple carriageways are selected, this number is used for them all.

It is interpreted in VLO that all lanes will have an equal width, equal to the carriageway width divided by the provided number of lanes. Unequal lane widths (if required) can be achieved by defining each lane as a separate carriageway and using the “From table” option.

Loading options

- Special vehicles** Vehicles are provided to BD86/11 Figures 3.1 to 3.7, and additionally to the highways Agency’s Heavy Load Vehicle Classification Specifications. Application with Type HA loading is as per BD86/11 clauses 3.20 to 3.30. An option is provided for speed of transit, allowing any configuration by default, or specifically either Normal speed or Low speed if desired. The Associated Type HA loading can be included in all lanes, only lanes which do not contain the Special vehicle, or can be excluded from all lanes (allowing a vehicle-only optimisation).
- Associated Type HA loading** Type HA loading is provided to BD21/01. The reduction factor is provided to Figures 5.2 to 5.7 based on selections made for Assessment load level, Road surface and Traffic flow.
For more detail on interpretations made for Type HA loading, see [BD21/01 Optional Settings](#).
- Include KEL loads** By default, one KEL is included per lane (except special vehicle lanes). This may be optionally disabled.
- Adjust base length at cusps** As required by BD37/01 note to Table 13, “*where the influence line has a cusped profile and lies wholly within a triangle joining the extremities of its base to its maximum ordinate, the base length shall be taken as twice the area under the influence line divided by the maximum ordinate*”. This may be optionally disabled.
- Allow HA-only load patterns** By default a Type HA only pattern is included, with ULS load factors to BD37/01 Table 1. This checks against the case where Type HA alone, with a high partial factor, is more onerous than a special

vehicle with Type HA at lower partial factors. This loading option may be optionally disabled, but note that this only removes the load pattern with higher factors; if Type HA with lower partial factors is still more onerous than the special vehicle then the optimisation will not place the special vehicle on the deck.

A Defaults button is provided to reset all values back to those specified in the design codes.

United Kingdom - BD86/11 Advanced Settings

Optional parameters			
<input type="checkbox"/>	Change lane factors	1, 1, 0.5, 0.4	
<input type="checkbox"/>	Change overload factors		
	Most onerous axle	1.2	
	Other axes	1.1	
<input checked="" type="checkbox"/>	Include DAF (normal speed)		
<input type="checkbox"/>	Include DAF (low speed)		

Partial load factors				
<input type="checkbox"/>	Change partial load factors (vfl)			
		Special vehicles	Associated Type HA loading	Type HA loading alone
	ULS combination 1	1.1	1.3	1.5
	ULS combinations 2 and 3	1	1.1	1.25
	SLS (and cast iron bridges)	1	1	1

This dialog is used to view and modify lane factors and partial load factors.

Optional parameters

- Change lane factors** This option allows the modification of the lane factors from the values in BD21/01 clause 5.24, which are implemented as default values. The textbox has a comma separated list of four variables, applicable respectively to: Lane 1, Lane 2, Lane 3, Lane 4 and subsequent.
- Change overload factors** The overload factors to BD86/11 clause 3.16 are applied to every special vehicle, to the most onerous axle and to all other axles as per the textboxes. These values may be optionally changed from the defaults.
- Include DAF (normal speed)** By default the Dynamic Amplification Factor to BD86/11 clause 3.17 is applied to all axles of the special vehicles at normal speed. This factor may optionally be removed.

- Include DAF (low speed)** By default the Dynamic Amplification Factor is not applied to special vehicles at low speed, as per BD86/11 clause 3.24. The factor, to clause 3.17, may optionally be included.

Partial load factors

- Change partial load factors (γ_{fl})** This option allows the modification of the partial load factors from the default values. These are taken from BD86/11 clauses 2.6 to 2.9; except for Type HA loading alone at ULS, which is taken from BD37/01 Table1.

A Defaults button is provided to reset the values back to those specified in the design codes.

United Kingdom - BD86/11 Implementation Notes

Design Manual for Roads and Bridges Vol 3, Section 4, Part 19: BD86/01 The Assessment of Highway Bridges and Structures for the effects of Special Types General Order (STGO) and Special Order (SO) Vehicles, last amended Nov 2011. Available freely from www.standardsforhighways.co.uk

Existing UK highway bridges which are assessed as adequate to carry the 40t loading of BD21/01 are deemed, in BD86/11 clause 1.3.1, adequate for vehicles complying with The Road Vehicles Construction and Use (C&U) Regulations and Authorised Weight (AW) Regulations. Bridges which have some spare capacity under BD21/01 may therefore be assessed for adequacy to carry one (or both) of the following:

- Vehicles complying with The Road Vehicles (Authorisation of Special Types) General Order (STGO) Regulations.** Five SV load models simulate the effects of real STGO vehicles as per BD86/11 clause 3.10
- Special Order (SO) Vehicles.** Four SOV load models simulate the effects of real SO vehicles within limits set out in BD86/11 clause 3.12, Table 3.1.

The SV and SOV load models of BD86/11 are applied together with associated Assessment Live Loading according to BD21/01, which is referred to (within BD86/11) as “Type HA loading”. BD86/11 Clauses 3.20 to 3.29 and Figures 3.9 and 3.10 apply and Type HA loading is excluded over a length preceding and following the SV and SOV load models depending on the speed of transit, being normal speed (25m exclusions) or low speed (5m exclusions). Accordingly options are offered in the user interface.

An overload factor of 1.1 is applied to all axles except for the most onerous axle, for which a value of 1.2 is used as per clause 3.16. A Dynamic Amplification Factor (DAF) is applied to all axles as given in clause 3.17. It is not, however, applied when the vehicle is travelling at low speed with the shorter (5m) exclusion length; see clause 3.24.

It may be of interest to the Highway Authority to consider what SV/SOV vehicle or what exceptional vehicle may be safely transported if specific traffic restrictions are in

place, for example, if a temporary 3t limit is placed on the bridge during the transit of an exceptional vehicle; therefore the options for associated live load allow user selection of the loading level required (40t, 26t, 18t, Group 1 FE, 7.5t, Group 2 FE, 3t), road surface category (good, poor) and traffic flow (high, medium, low) as appropriate.

It may also be of interest to the Highway Authority to consider what SV/SOV vehicle or what exceptional vehicle may be safely transported if all other vehicular loads are excluded from the bridge; or if all other loads are excluded from the lane(s) occupied by the abnormal vehicle – as per BD86/11 clause 1.5(ii). Likewise, referring to clause 1.5(ii), the Highway Authority may place special restrictions on load or speed, therefore options to control Overload factor, Dynamic Amplification Factor and/or load pattern are available.

For more information on the Associated Live Loads to BD21/01, see the [BD21/01](#) help entry.

Prior to 2001, it was mandatory in the UK to carry out STGO assessments using HB vehicles to BA34/90, which is also available within the LUSAS traffic load optimiser.

[BD86/11 Optional Settings](#) and [BD86/11 Advanced Settings](#) notes give further clarification on certain clauses of BD86/11 and their implementation within the LUSAS traffic load optimiser, and information on all available options.

United Kingdom - BS5400-2:1978 Optional Code Settings

This design code loading is supported by the LUSAS Traffic Load Optimisation software option.

When using the country “UK” and Design code “BS5400-2:1978”, road traffic loading is generated to BS5400-2:1978 Steel, concrete and composite bridges Part 2: Specification for Loads, incorporating Amendment No 4209. British Standards Institution, March 1983.

The scope of the vehicle load optimisation to BS5400-2:1978 is restricted to vertical highway traffic loading and global effects. Horizontal components and pedestrian loads are not currently included.

The Optional Code Settings dialog allows selection of the combinations and loads required. Factors used in the calculations may be viewed and modified if required, by accessing the [Advanced Settings](#) dialog.

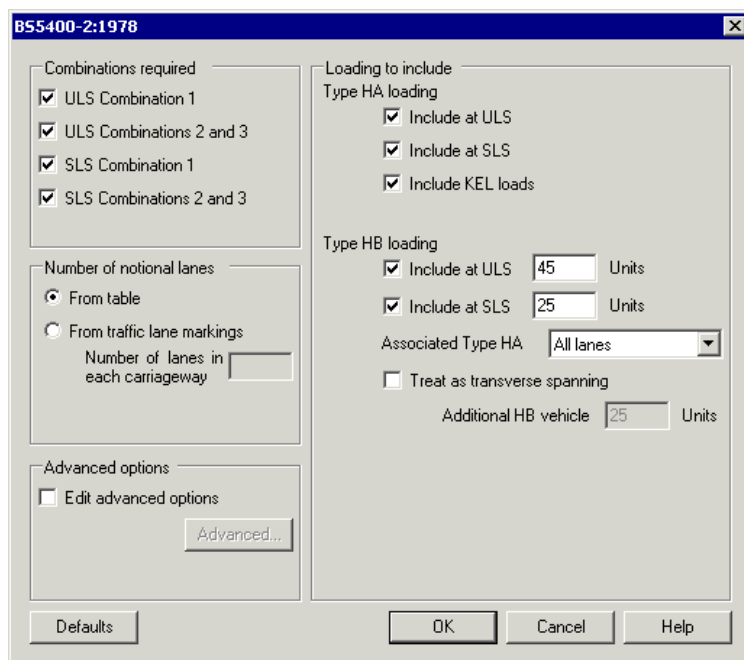

Combinations required

The combinations available on the dialog refer to those from BS5400-2:1978 Table 1 which contain highway bridges live loading. As the partial load factors in ULS combinations differ between different loads, it is necessary for the factors to be considered as part of the optimisation process.

Number of notional lanes

- From table** The road carriageway is by default divided into a number of equal width lanes as per BS5400-2:1978 Clause 3.2.9.3. This table has a limit of 22.8m, with 6 lanes. This option is hence not compatible with wider carriageways.
- From traffic lane markings** This option allows the input of the number of lanes. If multiple carriageways are selected, this number is used for them all.

It is interpreted in VLO that all lanes will have an equal width, equal to the carriageway width divided by the provided number of lanes. Unequal lane widths (if required) can be achieved by defining each lane as a separate carriageway and using the “From table” option, although this will prevent HB vehicles straddling lanes.

Loading options

- Type HA loading** HA loading is provided to BS5400-2:1978 clause 6.2.
 - **Include at ULS/SLS.** These options will include HA-only load patterns, BS5400-2:1978 clause 6.4.1.

- **Include KEL loads.** HB loading is provided to BS5400-2:1978 Clause 6.3. Application with Type HA is in accordance with BS5400-2:1978 Clause 6.4.2. The selection of the option to Treat as transverse spanning generates loading to Clause 6.4.3.1 instead. An option is provided for the 'Associated Type HA', allowing the inclusion of HA in all lanes, only lanes which do not contain the HB vehicle, or the exclusion of HA.
- **Type HB loading** HB loading is provided to BS5400-2:1978 Clause 6.3. Application with Type HA is in accordance with BS5400-2:1978 Clause 6.4.2. The selection of the option to **Treat as transverse spanning** generates loading to Clause 6.4.3.1 instead. An option is provided for the 'Associated Type HA', allowing the inclusion of HA in all lanes, only lanes which do not contain the HB vehicle, or the exclusion of HA.

A Defaults button is provided to reset all values back to those specified in the design codes.

United Kingdom - BS5400-2:1978 Advanced Settings

	HA alone	HB and associated HA
ULS Combination 1	1.5	1.3
ULS Combinations 2 and 3	1.25	1.1
SLS Combination 1	1.2	1.1
SLS Combinations 2 and 3	1	1

This dialog is used to view and modify lane factors and partial load factors.

Optional parameters

- **Change lane factors** In accordance with BS5400-2:1978 Clause 6.4.2.2, the factor for the lane with the HB vehicle and the adjacent lane is 1, and 1/3 for the remaining lanes. The textbox has a comma separated list of four variables, applicable respectively to: Lane 1, Lane 2, Lane 3, Lane 4 and subsequent.
- **Change HA UDL loading curve** By default the equation in BS5400-2:1978 Clause 6.2.1 is used. This option allows the specification of an alternative loading curve as a piecewise linear curve.

- ❑ **Change partial load factors (γ_{fl})** This option allows the modification of the partial load factors from the values in BS5400-2:1978 Table1, which are implemented as default values.
- ❑ **Include DAF (low speed)** By default the Dynamic Amplification Factor is not applied to special vehicles at low speed, as per BD86/11 clause 3.24. The factor, to clause 3.17, may optionally be included.
- ❑ **Change partial load factors (γ_{fl})** This option allows the modification of the partial load factors from the default values. These are taken from BD86/11 clauses 2.6 to 2.9; except for Type HA loading alone at ULS, which is taken from BD37/01 Table1.

A Defaults button is provided to reset the values back to those specified in the design codes.

United Kingdom - BS5400-2:1978 Implementation

Notes

When using the country “UK” and Design code “BS5400-2:1978”, road traffic loading is generated to BS5400-2:1978 Steel, concrete and composite bridges Part 2: Specification for Loads, incorporating Amendment No 4209. British Standards Institution, March 1983.

It may be of interest to the highway authority to design for an HB with all other vehicular loads are excluded from the bridge, or with all other loads restricted from the lane(s) occupied by the abnormal vehicle; therefore the options for associated live load allow user selection of these situations.

The notes below give further clarification on certain clauses of BS5400-2:1978 and their implementation within the LUSAS traffic load optimiser, and information on all available options.

- ❑ **Partial factor γ_{f3}** γ_{f3} , although mentioned in Clause 4.1.3 has not been included. This is as it is handled differently in different design codes (BS5400-3 clause 4.3.2, BS 5400-4 clause 4.2 and BS5400-5 clause 4.1.4), its value is not given in BS5400-2:1978, and it does not affect the generation of loading patterns.
- ❑ **Knife Edge Load (KEL)** Clause 6.4.1.4 indicates that the KEL may act in various directions in differing situations. The traffic load optimiser is a tool intended for global analyses and the KEL is always placed perpendicular to the lane direction.
- ❑ **Transverse spanning slabs** Clause 6.4.3.1 requires the consideration of two situations: either an HB vehicle occupying any position; or an HB vehicle in a notional lane with a 25unit HB vehicle in another notional lane. For the majority of lane widths this second situation would not be considered using lane widths to Clause 3.2.9.3.1, as this clause normally produces lanes too narrow to contain an HB vehicle (i.e. lanes less than 3.5m). In order to

implement the second situation, the carriageway is divided such that there are the maximum possible number of lanes of 3.5m minimum width, such that HB vehicles can be accommodated.

BS5400-2:1978 Optional Settings and **BS5400-2:1978 Advanced Settings** notes give further clarification on certain clauses of BS5400-2:1978 and their implementation within the LUSAS traffic load optimiser, and information on all available options.

United States of America - AASHTO LRFD (7th Edition)

Optional Code Settings

This design code loading is supported by the LUSAS Traffic Load Optimisation software option.

When the country 'United States of America' and the Design code 'AASHTO LRFD 7th Ed', is selected on the main Vehicle Load Optimisation dialog, road traffic loading data and parameters can be specified with reference to AASHTO LRFD Bridge Design Specifications, Seventh Edition.

Note that whilst all references in the LUSAS software and documentation are for the AASHTO LRFD 7th Edition, the LUSAS implementation is applicable to the both the AASHTO LRFD 7th Edition and the AASHTO LRFD 6th Edition.

Design codes are also available for many US State Bridge Design Manuals' implementations of AASHTO LRFD. See **State Implementations of AASHTO LRFD (7th Edition)** for more details.

Scope

The scope of the vehicle load optimisation to AASHTO LRFD (7th Edition) is restricted to vertical highway traffic loading and global effects. Horizontal components, railway loads and pedestrian loads are not currently included. The refined design truck for fatigue design of orthotropic decks, to Figure 3.6.1.4.1-1, is not included as it is considered applicable for local effects only.

The road carriageway is divided into standard 12ft design lanes (apart from carriageways from 20ft to 24ft wide which have two equal width lanes). This will result in a “remaining width” for any carriageways of width not an integer multiple of 12ft. The lanes are positioned laterally on the bridge to produce the most adverse effects, with the remaining width being placed either side of the lanes or between any of the lanes so as to produce the most onerous arrangement. The number of design lanes can be modified if required, as per AASHTO LRFD clause 3.6.1.1.1, via the **Advanced Settings** dialog. Loading moves transversely within the design lanes for most onerous effect.

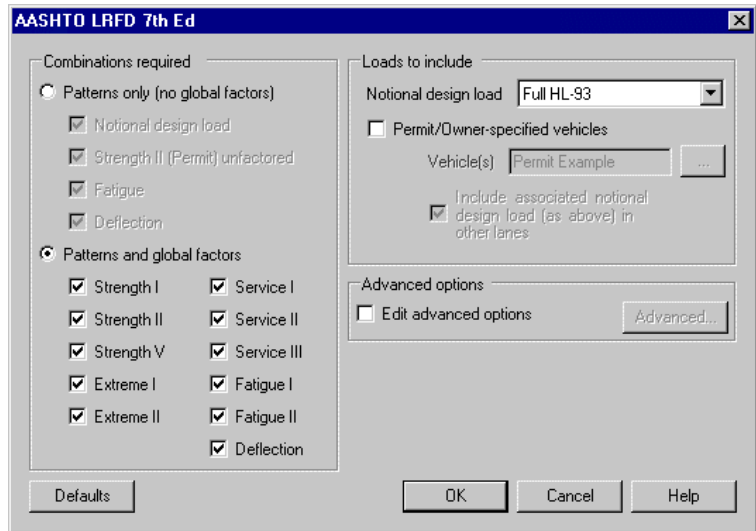

Dialog options

The Optional Code Settings dialog allows selection of the combinations and loads required. Factors used in the calculations and other settings may be viewed and modified if required, by accessing the Advanced Settings dialog.

Generic options that are applicable to all state implementations are described below. See [State Implementations of AASHTO LRFD \(7th Edition\)](#) for a particular state for dialog options unique to that state.

Combinations required

Loading patterns are available either globally factored (i.e. with a Load Factor for a Limit State to AASHTO LRFD Table 3.4.1-1, or optionally edited in the Advanced Settings dialog) or unfactored as follows:

Patterns only (no global factors)

- **Notional design load** - loading to AASHTO LRFD clause 3.6.1.3.1
- **Strength II (Permit) unfactored** - as Notional design load pattern but with a Permit vehicle replacing one lane of loading, where this is more onerous
- **Fatigue** - loading to AASHTO LRFD clause 3.6.1.4.1
- **Deflection** - loading to AASHTO LRFD clause 3.6.1.3.2

Patterns and global factors

- **Strength I / Strength V / Extreme I / Extreme II / Service I / Service II / Service III** - as per Notional design load pattern but with the relevant global factor from AASHTO LRFD Table 3.4.1-1
- **Strength II** - as per Strength II (Permit) unfactored pattern but with the relevant global factor from AASHTO LRFD Table 3.4.1-1
- **Fatigue I / Fatigue II** - as per Fatigue pattern but with the relevant global factor from AASHTO LRFD Table 3.4.1-1
- **Deflection** - as per unfactored Deflection pattern but with the Service I global factor from AASHTO LRFD Table 3.4.1-1

The dialog allows selection of one or more combinations. The most onerous traffic loading pattern appropriate to each selected combination will be determined, with load factors included as appropriate.

Loads to include

- Notional design load.** If “Full HL-93” is selected, the most onerous of the Design Truck or Design Tandem will be placed in each lane. If “Truck & lane loads only” or “Tandem & lane loads only” is selected, then the Design Truck or Design Tandem respectively will be placed in all lanes. This selection also affects the alternative loading for interior piers, i.e. the two truck loading and two tandem loading (for further details see [Advanced Settings](#) dialog).
- Permit/Owner-specified vehicles.** This option is available when either of the Strength II combinations is selected. If this option is selected then the most onerous of the selected Vehicles will replace one lane of loading for these combinations, provided it is more onerous than the selected Notional design load for that lane.
 - **Vehicle(s).** Clicking the “...” button allows selection of one or more Permit vehicles. As no Permit vehicles are defined within AASHTO LRFD 7th Edition, an example vehicle is provided. State implementations have relevant vehicles as defined by their State Bridge Design Manuals, as appropriate.
 - **Include associated notional design load (as above) in other lanes.** This check box may be unchecked in order to obtain a result for Permit vehicles alone.

Multiple presence factors are applied to the loading as per AASHTO LRFD clause 3.6.1.1.2, or optionally edited via the Advanced Settings dialog. The optimisation process takes account of the multiple presence factors when calculating the most onerous load effect, such that every lane may not be loaded. As per clause 3.6.1.1.2 they are not applied to the Fatigue loading. By default the 1.20 factor for a single loaded lane is not applied to Permit vehicles alone - the factor of 1.2 for a single lane loaded is due to HL-93 having been originally calibrated for two lanes, and it is

assumed that this calibration has not been applied to Permit vehicle definitions. This setting can, however, be modified in the **Advanced Settings** dialog.

The dynamic load allowance to AASHTO LRFD clause 3.6.2.1 is applied to all vehicles in all combinations, but not to the design lane load. The values for All Other Components to Table 3.6.2.1-1 are applied by default; modifications are possible via the **Advanced Settings** dialog.

Two truck loading and two tandem loading for interior piers is included when the 'Alternative load pattern' option is selected on the Set Influence Surfaces dialog. (See also **Advanced Settings** dialog for further details on the two tandem loading).

A Defaults button is provided to reset all values back to those specified in AASHTO LRFD (or the selected State Bridge Design Manual).

AASHTO LRFD (7th Edition) Optional Code Settings (Advanced)

This dialog is used to view and modify dynamic factors, multiple presence factors, global factors and a number of additional settings.

Load pattern definition

- Exclude relieving axes.** AASHTO LRFD clause 3.6.1.3.1 states “Axles that do not contribute to the extreme force effect under consideration shall be neglected.” By default relieving axes are therefore excluded from generated loading, but all vehicle axles may be included by unchecking this option.

- Design truck rear axle spacing.** The Design Truck from AASHTO LRFD clause 3.6.1.2.2 has a rear axle which varies from 14ft to 30ft; this is implemented by default. This option gives the opportunity to restrict which axle spacings are considered in order to give a faster optimisation process. Axle spacing options should only be restricted when engineering judgement deems this will give a sufficiently accurate result. This option does not affect the axle spacing where it is specified elsewhere, i.e. two trucks (for interior piers) will still have a 14ft rear axle to AASHTO LRFD clause 3.6.1.3.1 and for fatigue the truck will still have a 30ft rear axle to AASHTO LRFD clause.
- Include two tandem alternative to two truck.** This option allows the inclusion, to AASHTO LRFD commentary clause C3.6.1.3.1, of a two tandem alternative to the two truck loading. When selected it does not replace the two truck loading, rather it is an additional load, with the most onerous being selected. This option is unchecked by default for AASHTO LRFD 7th Ed, but may be checked by default according to a State's Bridge Design Manual.
- Change dynamic load allowance (IM).** This option allows the modification of the IM from the values in AASHTO LRFD Table 3.6.2.1-1 for All Other Components, which are implemented as default values. Dynamic load allowance is applied to all vehicles in all combinations, but not to the design lane load.
- Change multiple presence factors (MPFs).** This option allows the modification of the MPFs from the values in AASHTO LRFD Table 3.6.1.1.2-1, which are implemented as default values. The textbox has a comma separated list of four variables, applicable respectively to: one lane loaded, two lanes loaded, three lanes loaded, more than three lanes loaded.
- Different MPF for single lane of Permit.** By default the 1.20 factor for a single loaded lane is not applied to Permit vehicles alone - the MPF of 1.2 for a single lane loaded is due to HL-93 having been originally calibrated for two lanes, and it is assumed that this calibration has not been applied to Permit vehicle definitions. This is in accordance with many States' Bridge Design Manuals. However, the default is changed for those States whose manuals specifically use an MPF of 1.2 for Permit vehicles.
- Specify number of lanes.** By default the carriageway is divided into standard 12ft design lanes, or two equal width lanes for carriageways from 20ft to 24ft wide, as per AASHTO LRFD clause 3.6.1.1.1. This option is provided in accordance with the same clause, allowing the number of design lanes to be specified if their width is less than 12ft. If this option is selected the carriageway will be divided into the specified number of equal width lanes, although the lanes may not be less than 10ft wide due to the width of the notional design loads.
- Transverse vehicle position for deck overhang design.** As per AASHTO LRFD clause 3.6.1.3.1 the wheel loads should usually be restricted to 2ft from the edge of the design lane / curb, but should be allowed within 1ft of the curb for the design of the deck overhang. By default the wheel loads are therefore

restricted to 2ft from the edge of the carriageway, but on selecting this option that distance is reduced to 1ft.

Global factors

- Change global factors.** The default values provided to AASHTO LRFD Table 3.4.1-1 may optionally be edited. γ_{EQ} for Extreme I, which is to be determined on a project specific basis, has been assigned a default of 0.50. NB The default value for the factored Deflection combination is that for Service I, as per AASHTO LRFD clause 3.4.2.2, but may be edited to be different to that for Service I. The value entered is only used for the factored Deflection combination and not for the unfactored combination.
- A **Defaults** button is provided to reset all values back to those specified in AASHTO LRFD (or the selected State Bridge Design Manual).

AASHTO LRFD (7th Edition) Special Vehicle Selection

By clicking the  button on the Optional Code Settings dialog a Special Vehicle Selection dialog is displayed. This allows the inclusion of a Permit Example.

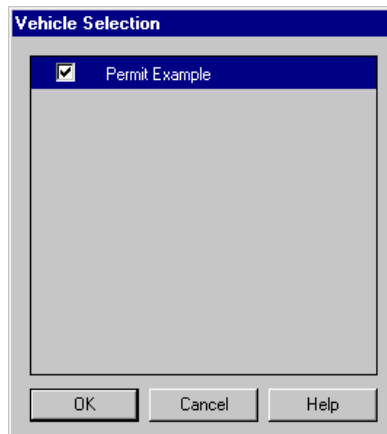

State Implementations of AASHTO LRFD (7th Edition)

The majority of the Departments of Transportation in the United States publish a Bridge Design Manual or equivalent, which may clarify, add to, or modify the requirements of AASHTO LRFD. The list below shows which States' manuals have been implemented, along with details of any additions or modifications.

Unless otherwise noted for a particular State, all Permit/Owner-specified vehicles below are implemented with a 6-foot transverse wheel spacing and excluding all other loads from their lane, but allowing HL-93 loads in other lanes.

- ❑ **Alabama** - ALDOT Structural Design Manual, June 2014 to October 2016 - No changes to AASHTO loading.
- ❑ **California** - not currently implemented.
- ❑ **Connecticut** - not currently implemented.
- ❑ **Delaware** - DelDOT Bridge Design Manual, May 2005 - No changes to AASHTO loading. DelDOT Bridge Design Manual, October 2016 - The Load factor for Service III is set to 1.0
- ❑ **Florida** - FDOT Structures Design Guidelines, January 2014 to January 2017 - The load factor for Extreme I is set to 0.0 as per FDOT SDG clause 2.1.1
- ❑ **Georgia** - Georgia DOT LRFD Bridge and Structure Design Manual, October 2013 to October 2016 - No changes to AASHTO loading.
- ❑ **Hawaii** - (Email from HIDOT) - No changes to AASHTO loading.
- ❑ **Idaho** - Idaho LRFD Bridge Design Manual, April 2008 - Two tandem loading is included by default as per Idaho LRFD BDM clause 3.6.1.3.1. The load factor for Extreme I is set to 0.0 as per Idaho LRFD BDM clause 3.4.1.
- ❑ **Illinois** - Illinois DOT Bridge Manual, January 2012 - No changes to AASHTO loading.
- ❑ **Indiana** - Indiana Design Manual (2013), Indiana Department of Transportation, May 2017. The ability to choose state-specific Permit/Owner-specified vehicles is included on the Optional Code Settings dialog.
- ❑ **Iowa** - Iowa DOT LRFD Bridge Design Manual, July 2014 - No changes to AASHTO loading.
- ❑ **Kansas** - not currently implemented.
- ❑ **Kentucky** - Division of Structural Design Guidance Manual, as modified by Transmittal Memorandum 08-01-2008 - The HL-93 loads are by increased 25% to create KY-HL-93 loading, as per Transmittal Memorandum 08-01 clause 3.6.1.2. This increase is applied to Fatigue and Deflection loading also.
- ❑ **Louisiana** - LRFD Bridge Design Manual No 2 (June 2016), Department of Transportation and Development, State of Louisiana. The option to apply or not apply magnification factor (LADV-11 loading) is allowed for. When applied, an extra column in the influence dialog is provided to input the magnification factor (MF) for each influence.
- ❑ **Louisiana** - Louisiana LRFD Bridge Design Manual 1st Ed, September 2008 - The Louisiana Special Design Vehicles specified in LADOTD LRFD Bridge Design Manual Figure 3.1 are included in the Strength II limit state.
- ❑ **Louisiana** - LRFD Bridge Design Manual 1st Ed, September 2008 (inc BDTM to Feb 2009) - The Louisiana Special Design Vehicles specified in LADOTD LRFD Bridge Design Manual Figure 3.1 are included in the Strength II limit state and the Live Load Factor for Service III Limit State to 1.00 as per BDTM.02.

- ❑ **Maine** - MaineDOT Bridge Design Guide (March 2014). The ability to choose between “Maine modified live load” or “Normal HL-93 live load”, for the Strength I design case is allowed for on the Optional Code Settings dialog.
- ❑ **Maryland** - (Email from Maryland SHA) - No changes to AASHTO loading.
- ❑ **Massachusetts** - Massachusetts LRFD Bridge Manual, 2009 - The load factor for Extreme I is set to 0.0 as per massDOT Bridge Design Manual clause 3.4.3.2.
- ❑ **Michigan** - MDOT Bridge Design Manual, August 2009 - The design tandem is replaced with a single 60 kip load and all loads are multiplied by 1.2 to create HL-93 Mod loading as per MDOT Bridge Design Manual clause 7.01.04. The optional dual tandem is also replaced by an optional dual 60 kip load. Fatigue and Deflection loading is not increased from standard AASHTO loading.
- ❑ **Minnesota** - LRFD Bridge Design (May 2016 to March 2017) Minnesota Department of Transportation. The ability to choose between 125% or 110% of HL-93 is provided in the Optional Code Settings dialog. Also the option of 90% of HL-93 (general AASHTO) is given.
- ❑ **Mississippi** - (Email from MDOT) - No changes to AASHTO loading.
- ❑ **Missouri** - Missouri LRFD Bridge Design Guidelines - No changes to AASHTO loading.
- ❑ **Montana** - Montana Structures Manual, August 2002 - No changes to AASHTO loading.
- ❑ **Nebraska** - NDOR BOPP, April 2014 - The load factor for Strength I is increased from 1.75 to 2.0 as per NDOR BOPP Clause 2.2.2.
- ❑ **Nevada** - NDOT Structures Manual (May 2014). The ability to choose state-specific Permit/Owner-specified vehicles is included on the Optional Code Settings dialog.
- ❑ **New Hampshire** - NHDOT Bridge Design Manual v2.0 (January 2015) - No changes to AASHTO loading.
- ❑ **New Jersey** - not currently implemented.
- ❑ **New Mexico** - NMDOT Bridge Procedures and Design Guide, April 2013 - The Permit Vehicle P327-13 is included in the Strength II limit state as per NMDOT Bridge Procedures and Design Guide clause 3.1.13. NB Figure 3.1B plan view shows four wheels of 6.25kip each; transverse spacing between wheel pairs is defined as 6ft but no transverse spacing within the pairs is defined. AASHTO LRFD clause C3.6.1.2.5 gives tyre contact width (in inches) as $P(\text{in kip})/0.8 = 6.25/0.8 = 7.8125\text{in}$. P327-13 has therefore been implemented with 7.8125in transverse spacing between wheels in a pair.
- ❑ **New York** - NYSDOT LRFD Bridge Design Specifications, September 2011 to April 2014, with implementation notes as shown below

- NYSDOT Design Permit Vehicle is available in one lane with HL-93 in other lanes if “Include associated notional design load (as above) in other lanes” is checked, or in every lane if the option is unchecked.
 - NYSDOT Design Permit Vehicle is included in the combinations Strength II and, for pre-stressed concrete bridges, Service III as per NYSDOT LRFD Bridge Design Specifications clause 3.6.1.2.4a.
 - When the NYSDOT Design Permit Vehicle is applied to a single design lane, only the multiple presence factor for one lane loaded (see clause 3.6.1.1.2) shall be included.
- North Carolina** - North Carolina Structure Design Manual, February 2014 - No changes to AASHTO loading.
- North Dakota** - North Dakota DOT Design Manual, July 2011 to May 2017 - No changes to AASHTO loading.
- Ohio** - Ohio Bridge Design Manual, July 2007, rev 2015 - The load factor for Extreme I is set to 0.0 as per Ohio Bridge Design Manual clause 1003 - S3.10.9.2.
- Oklahoma** - not currently implemented.
- Oregon** - Oregon Bridge Design and Drafting Manual, October 2013 to October 2016 - The permit trucks ODOT OR-STP-5BW and ODOT OR-STP-4E are included in the Strength II limit state as per Oregon Bridge Design and Drafting Manual clause 1.3.2.
- Pennsylvania** - PennDOT Design Manual - Part 4, May 2012 to April 2015, with implementation notes as shown below:
- Combinations Strength IP, Extreme III, Extreme IV, Service I (with PL), Service IIB, Service III (with PL), Service IIIA and Service IIIB are included as per PennDOT Design Manual Part 4 Part B clause 3.4
 - The design tandem’s axles are increased to 31.25kips as per PennDOT Design Manual Part 4 Part B clause 3.6.1.2.3
 - The P-82 permit load as per PennDOT Design Manual Part 4 Part B clause 3.6.1.2.7P is included in combinations Strength II, Extreme III, Extreme IV, Service IIB, Service IIIA and Service IIIB. It is available in one lane with PHL-93 in other lanes if “Include associated notional design load (as above) in other lanes” is checked, or in every lane if the option is unchecked. The P-82 permit load has its own dynamic load allowance setting on the Advanced settings dialog
 - An option is included for “Truck loading on continuous spans” with gives the option of “100% (for moments)” or “90% (for reactions)”. This option only affects the pair of design trucks; if a single truck is more onerous it will always be at 100%. The pair of tandems is similarly unaffected. NB

Loading for continuous spans is only applicable if the “Alternative load pattern” option is selected, per influence, on the influence selection dialog

- ❑ **Rhode Island** - Rhode Island LRFD Bridge Design Manual, January 2007 - The live load for deflection is replaced by the most onerous of 125% of the Design Truck or 33% of the Design Truck with the Design Lane as per LRFD Bridge Design Manual clause 3.4.5. The load factor for Extreme I is set to 0.0 as per LRFD Bridge Design Manual clause 3.2.3.
- ❑ **South Carolina** - South Carolina Bridge Design Manual, April 2006 - No changes to AASHTO loading.
- ❑ **South Dakota** - (Email from SD DOT) - The SD agency vehicles SD Strength II Long and SD Strength II Short are included in the Strength II limit state.
- ❑ **Tennessee** - (Email from Tennessee DOT) - No changes to AASHTO loading.
- ❑ **Texas** - Texas DOT Bridge Design Manual, LRFD, March 2013 to October 2015 - No changes to AASHTO loading.
- ❑ **Utah** - Design Memorandum November 2010 to February 2015 - No changes to AASHTO loading.
- ❑ **Vermont** - VTrans Structures Design Manual, 2010 - No changes to AASHTO loading.
- ❑ **Virginia** - VDOT Modifications to AASHTO LRFD 6th Ed, January 2013 to August 2015 - No changes to AASHTO loading, but note that the Multiple Presence Factors may need manually editing via the Advanced Settings Dialog for specific structural elements and spans, to meet the requirements of VDOT Modifications Section 3.
- ❑ **Washington** - WSDOT Bridge Design Manual, August 2012 to June 2016 - Two tandem loading is included by default as per WSDOT Bridge Design Manual clause 3.9.1
- ❑ **West Virginia** - WVDOH Bridge Design Manual, March 2004 to August 2016 - No changes to AASHTO loading.
- ❑ **Wisconsin** - Wisconsin Bridge Manual, January 2014 to January 2017 - The Wisconsin Standard Permit Vehicle (Wis-SPV) from WisDOT Bridge Manual Figure 45.6-1 is included in the Strength II limit state.
- ❑ **Wyoming** - WYDOT Bridge Design Manual, April 2013 - No changes to AASHTO loading.

United States of America - AASHTO Standard Specifications (17th Edition) Optional Code Settings

This design code loading is supported by the LUSAS Traffic Load Optimisation software option.

When using the country “United States of America” and Design code “AASHTO Standard Specifications 17th Ed”, road traffic loading is generated with reference to AASHTO Standard Specifications for Highway Bridges, 17th Edition - 2002.

In the Design code droplist you can also select one of many State Design manuals. See [State Implementations of AASHTO Standard Specifications](#) for more details.

The scope of the vehicle load optimisation to AASHTO Standard Specifications is restricted to vertical highway traffic loading and global effects. Horizontal components, railway loads and pedestrian loads are not currently included.

The roadway width is divided into 12ft design lanes (apart from roadways from 20ft to 24ft wide which have two design lanes of equal width). This will result in a “remaining width” for any roadways of width not an integer multiple of 12ft. The lanes are positioned transversely on the bridge to produce the most adverse effects, with the remaining width being placed either side of the lanes or between any of the lanes so as to produce the most onerous arrangement. The number of design lanes can be modified if required, via the Advanced Settings dialog. Loading moves transversely within the design lanes for most onerous effect.

Attention should be paid to the value set for “Minimum distance between concentrated loads on continuous spans” to ensure that the two concentrated loads are placed for maximum effect. See [AASHTO Standard Specifications 17th Edition Advanced Settings](#) for more information.

AASHTO Standard Specifications 17th Edition Optional Settings

The screenshot shows the 'AASHTO Standard Specifications 17th Ed' dialog box. It is divided into several sections:

- Combinations required:**
 - Patterns only (no global factors)
 - Notional design loading
 - Single Truck (unfactored Group IA)
 - Overload Vehicle (unfactored Group IB)
 - ASD global factors
 - LFD global factors

Group	Service	Load Factor
Group I	<input checked="" type="checkbox"/>	<input checked="" type="checkbox"/>
Group IA	<input checked="" type="checkbox"/>	<input checked="" type="checkbox"/>
Group IB	<input type="checkbox"/>	<input type="checkbox"/>
Group III	<input checked="" type="checkbox"/>	<input checked="" type="checkbox"/>
Group IV	<input checked="" type="checkbox"/>	<input checked="" type="checkbox"/>
Group VI	<input checked="" type="checkbox"/>	<input checked="" type="checkbox"/>
Group VIII	<input checked="" type="checkbox"/>	<input checked="" type="checkbox"/>
Group X	<input checked="" type="checkbox"/>	<input checked="" type="checkbox"/>
- Include γ load factor
- Advanced options:**
 - Edit advanced options (Advanced... button)
- Loading required:**
 - Influence type for concentrated load and impact allowance:
 - Moment
 - Shear
 - Loading system: HS 20-44
 - Gross weight designation (W): 20.0
 - Truck loading
 - Total truck weight: 72.0E3 lb
 - Lane loading
 - Concentrated lane load: 18.0E3 lb
 - Uniform lane load: 640.0 lb/ft
 - Alternate Military Loading
 - Overload Group IB vehicles
 - Vehicle(s): Overload Example
 - Include other loading (as above) in other lanes
- Impact allowance:** 30 %

The Optional Code Settings dialog allows selection of the combinations and loads required. Factors used in the calculations and other settings may be viewed and modified if required, by accessing the [Advanced Settings](#) dialog.

All clauses referenced below are taken from AASHTO Standard Specifications 17th Edition unless noted otherwise.

Combinations required

Loading patterns are available either globally factored (i.e. with a Load Factor and Coefficient for a Combination to Table 3.22.1A, or optionally edited in the [Advanced Settings](#) dialog) or unfactored as follows:

- Patterns only (no global factors)**
 - Notional design load - loading to clause 3.7
 - Single Truck (unfactored Group IA) - loading to clause 3.5.1
 - Overload Vehicle (unfactored Group IB) - loading to clause 3.5.2
- ASD global factors**

- Service for: Group I / Group III / Group IV / Group VI / Group VIII / Group X - as per Notional design load pattern but with the relevant β factor (and, if checked below, γ factor) from Table 3.22.1A
- Service for: Group IA - as per Single Truck pattern but with the relevant β factor (and, if checked below, γ factor) from Table 3.22.1A
- Service for: Group IB - as per Overload Vehicle pattern but with the relevant β factor (and, if checked below, γ factor) from Table 3.22.1A

LFD global factors

- As ASD global factors, but β and γ factors are available for both Service and Load Factor combinations

The dialog allows selection of one or more combinations. The most onerous traffic loading pattern appropriate to each selected combination will be determined, with load factors included as appropriate.

Loading required

- Influence type** The choice of “Moment” or “Shear” affects the required Concentrated lane load.
- Loading system** The four standard classes of highway loading to clause 3.7.2 are available, as are options for user-defined gross weight designation to either clause 3.7.5 using “H (W)” or clause 3.7.6 using “HS (W)”. When a State Implementation specifies “HS 25” loading, this is also made available for selection.
- Truck loading / Lane loading / Alternate Military Loading** These load types can be removed from the optimisation if desired. Feedback is given on the weight of the truck and lane loads, based on the selections made above.
- Overload Group IB vehicles** This option is available when any of the Group IB combinations is selected.
 - **Vehicle(s)** Clicking the “...” button allows selection of one or more Overload vehicles. As no Overload vehicles are defined within AASHTO Standard Specs 17th Ed, an example vehicle is provided. State implementations have relevant vehicles as defined by their State Bridge Design Manuals, as appropriate.
 - **Include other loading (as above) in other lanes** Unless otherwise noted, Overload vehicles are assumed to occupy one lane only. If this option is checked, Truck loading, Lane loading and Alternate Military Loading will be allowed in other lanes, provided their options are checked. Note that if the Truck/Lane/Alternate Military Loading is more onerous than the Overload vehicle, the load pattern generated will not include the Overload

vehicle. If this option is unchecked, the load pattern generated will be for the Overload vehicle alone.

Impact allowance

- Impact allowance** is applied to all loads as per clause 3.8.1. The same allowance is applied to all loads.

When multiple lanes are loaded, all loads (including any Overload vehicle) are reduced in intensity as specified in clause 3.12.1. The optimisation process takes account of this reduction when calculating the most onerous load effect, such that the most onerous pattern of load may be where the number of lanes loaded is fewer than the maximum available.

Two concentrated loads, for lane loads on continuous spans to clause 3.11.3, are included when the “Include additional load patterns” option is selected on the Influence Surface dialog.

A Defaults button is provided to reset all values back to those specified in AASHTO Standard Specs 17th Edition (or the selected State Bridge Design Manual).

AASHTO Standard Specifications (17th Edition) Advanced Code Settings

This dialog is used to view and modify global factors and a number of other settings.

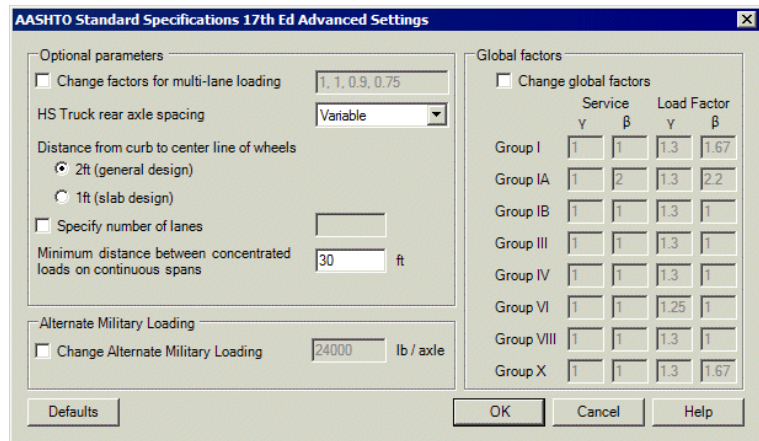

Optional parameters

- Change factors for multi-lane loading** This option allows the modification of the factors used to reduce load intensity when multiple lanes are loaded. The default values are based on clause 3.12.1, with the percentage values converted to factors by dividing by 100. The textbox has a comma separated list of four

variables, applicable respectively to: one lane loaded, two lanes loaded, three lanes loaded, more than three lanes loaded.

- ❑ **HS Truck rear axle spacing** The HS Truck from Figure 3.7.7A has an axle spacing which varies from 14ft to 30ft; this is implemented by default. This option gives the opportunity to limit which axle spacings are considered in order to give a faster optimisation process. Axle spacing options should only be restricted when engineering judgement deems this will give a sufficiently accurate result.
- ❑ **Distance from curb to center line of wheels** As per clause 3.24.2 and footnotes to Figures 3.7.6A and 3.7.7A, the wheel loads should usually be restricted to 2ft from the edge of the design lane / curb, but should be allowed within 1ft of the curb for slab design.
- ❑ **Specify number of lanes** By default the carriageway is divided into standard 12ft design lanes, or two equal width lanes for carriageways from 20ft to 24ft wide, as per clause 3.6. This option is provided to allow the number of design lanes to be specified if their width is less than 12ft. If this option is selected the carriageway will be divided into the specified number of equal width lanes, although the lanes may not be less than 10ft wide due to the width of the standard truck and lane loads.
- ❑ **Minimum distance between concentrated loads on continuous spans** Clause 3.11.3 allows two concentrated loads which must be in separate spans. This is currently implemented by requiring a minimum distance between the two loads. The required minimum distance to keep them in separate spans, while not forcing them so far apart that they cannot be placed at the local peak adverse influence ordinates, varies depending on span lengths and their ratios to each other. If the defined minimum spacing is too small for a given bridge, VLO may place both loads in the same span. This is incorrect but conservative. If the defined minimum spacing is too large for a given bridge, VLO will not be able to place both loads on the peak influences of their spans. This is incorrect and unconservative. For typical span ratios, a value of 2/3 of the maximum span is usually appropriate.

Alternate Military Loading

- ❑ **Change Alternate Military Loading** The default for the Alternate Military Loading is 24000 pounds per axle, as per clause 3.7.4. This option allows the value to be edited.

Global factors

- ❑ **Change global factors** The default values provided to Table 3.22.1A may optionally be edited. NB Irrespective of what is entered on the Advanced Dialog, γ factors can be removed by unchecking the option of the Code Settings Dialog.

A Defaults button is provided to reset all values back to those specified in AASHTO Standard Specs 17th Ed (or the selected State Bridge Design Manual).

State Implementations of AASHTO Standard Specifications (17th Edition)

Many States' DoTs publish a Bridge Design Manual or equivalent, which may clarify, add to, or modify the requirements of AASHTO Standard Specs 17th Ed. The list below contains those States whose manuals are implemented in LUSAS, along with details of any additions or modifications.

- Alaska** - Alaska Highway Preconstruction Manual, November 2013 - The design live load is HS-25 as per Alaska Highway Preconstruction Manual clause 1120.3.2.
- Arizona** - Arizona DOT Bridge Practice Guidelines Section 3, June 2002 - No changes to AASHTO loading
- Arkansas** - Arkansas Highways Interoffice Memorandum "Live Load for Bridges", October 1984 - No changes to AASHTO loading
- Colorado** - Colorado DOT Bridge Design Manual Section 3, November 1999 - The Colorado permit Vehicle from Colorado DOT Bridge Design Manual Subsection 3.2 is included. It is available from the Vehicle selection dialog as either "every lane" or "single lane". The "single lane" vehicle is compatible with the "Include other loading in other lanes" options.
- District of Columbia** - D.C DoT Design and Engineering Manual, April 2009 - The design live load is HS25 as per D.C DoT Design and Engineering Manual clause 15.1
- New Hampshire** - New Hampshire DOT Bridge Design Manual, October 2000 - The design live load is HS-25 as per New Hampshire DOT Bridge Design Manual clause 602.1. The Alternate Military Loading is 30000 pounds per axle as per New Hampshire DOT Bridge Design Manual clause 602.1.
- Puerto Rico** - Puerto Rico Highway Design Manual (El Manual de Diseño de Carreteras), 1979 - No changes to AASHTO loading

Design Code Special Vehicles and User-defined Vehicles

By clicking the  button on the Optional Code Settings dialog for a Vehicle Load Optimisation supported design code, a Special Vehicle Selection dialog is displayed. This allows the check-box selection of one or more special vehicles appropriate to the design code or, in the case of the Eurocode, a respective National Annex, for inclusion / exclusion from a VLO assessment.

User-defined special vehicles may also be created, and if done, can be accessed via the Optional Code Settings dialog. See Online help > Worked Examples > For LUSAS

Bridge and LUSAS Civil & Structural > ‘Add a User Vehicle to the Vehicle Load Optimisation Facility’ for more details.

Rail Load Optimisation

Overview

Rail Load Optimisation is provided for use with selected Bridge software products only, and only for licences that support this facility.

Rail load optimisation (RLO) makes use of influence lines and **direct method influence analysis for rail use** to identify the most onerous train loading arrangement for pre-defined **track layouts**, for a supported design code, and applies these train loading patterns to LUSAS models. It reduces the amount of time spent generating loadcases to replicate design code-based train loading on models and leads to more efficient and economic design, assessment or load rating of rail bridge structures. It is for use with shell or plate models; line beam models are not currently supported.

Direct Method Influence analysis for rail use is carried out to evaluate worst-case effects arising from a unit load applied to a rail location for chosen track loading configurations.

Rail load optimisation can be applied to decks of structures modelled with beam, plate or shell elements.

Performing a rail load optimisation analysis

Once a structural model is built, the stages required to evaluate the effect of the most onerous train loading patterns on specified track layouts on a bridge using Rail Load Optimisation analysis are shown below. A simple plate/shell model for analysing train loading for a number of indicative mid-span influence points is shown to illustrate the stages involved.

Stage 1: Define tracks and track layouts

The centreline of each length of track supported by the structure must be defined. This is normally done by adding and selecting lines and arcs in the LUSAS model that are drawn to represent the track centrelines. The transverse distance between rail loads on

the track must also be stated. A separate track definition is required for each length of track that will be used to define a viable loadable track layout.

See [Track definition](#) and [Track layouts](#) for more details.

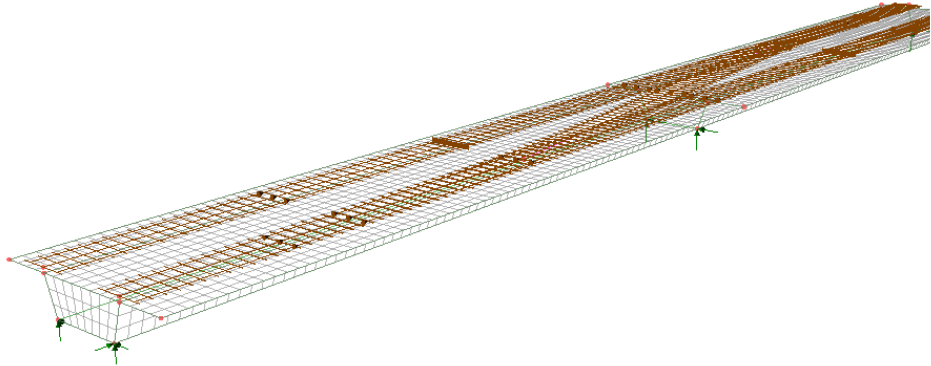

Tracks and track layouts defined

Stage 2: Assign Direct method influence attributes to the model

Direct method influence attributes must be assigned to selected positions (nodes or points of interest) on the model. To aid in this process track layouts can be made invisible and surfaces representing the deck or soffit of the bridge could be set as only visible to aid in the selection of suitable locations of interest.

See [Direct Method Influence Attributes](#) for more details.

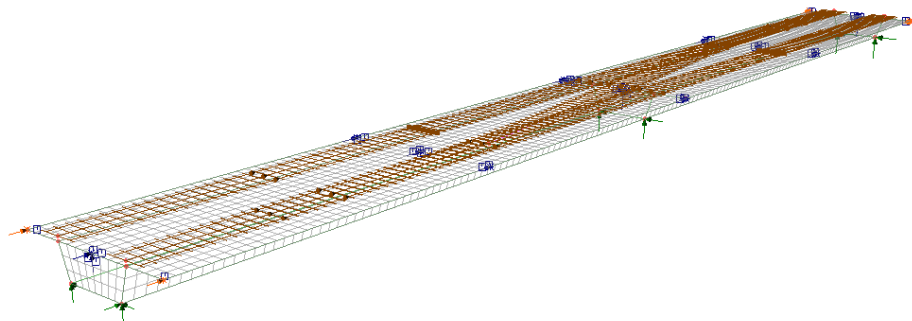

Influence attributes assigned and visualised

Stage 3: Solve the model for a Rail DMI Analysis to generate influence surfaces.

A Direct Method Influence analysis for rail use must be run to generate the influence shapes for the assigned influence attributes. When done, an influence line is generated beneath each rail and these influence lines can be viewed for each influence position for each track layout included in the analysis.

See [Direct Method Influence analysis for rail use](#) for more details.

Viewing influence shapes

After an influence analysis has been carried out the influence shape for each influence point of interest can be seen by setting each influence loadcase active, in turn, in the Analyses Treeview. The influence shape for each rail of each included track is shown below for a selected influence assignment.

The influence shape can be viewed on the **Influence shape** layer in the Layers Treeview. This layer replaces the Deformed mesh layer when a direct method influence analysis loadcase is active. Note that the influence shape for a particular track layout can only be displayed if that track layout is set to be visible.

Note that when a Direct Method influence analysis for rail use has been solved for one assigned attribute the effect of a unit load on any part of the structure can be seen immediately for any subsequently assigned influence attributes.

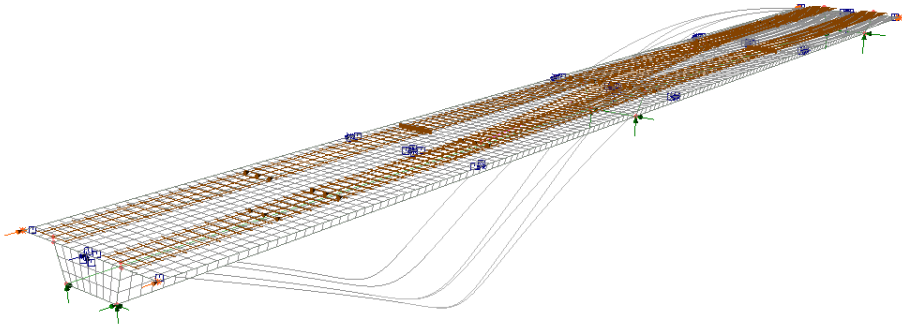



Viewing influence shapes under the rails

Stage 4: Run a Rail Load Optimisation Analysis

Running the Rail Load Optimisation wizard requires the selection of a design code, and specifying the influences to be used, the track layout to be considered, and whether loading patterns should be created. Once run, the critical loading pattern can be optionally displayed prior to calculating the effects of the loading on the model.

A successful analysis will add a Rail Direct Method Influence Analysis entry as well as a RLO Analysis entry (and RLO runs) to the Analyses  Treeview. These entries permit viewing of influence shapes and rail loading patterns prior to solving the model for those loading patterns.

Any number of RLO Analysis entries can be created in the Analyses  Treeview. Each RLO Analysis entry can contain any number of RLO runs (shown by this icon ) , with each run containing loadcases generated by the rail load optimisation software according to the chosen design code and associated settings chosen. Each loadcase comprises train and track loadings appropriate to the design code selected that, when solved, will generate the most adverse positive or negative loading effect for each of the influence points of interest, as defined on the model. If desired, it is possible to set-up one RLO run to investigate Positive effects and a separate run to investigate Negative effects, or they can be combined into one run, all within the same Analysis. RLO runs can be copied and pasted between different RLO analyses.

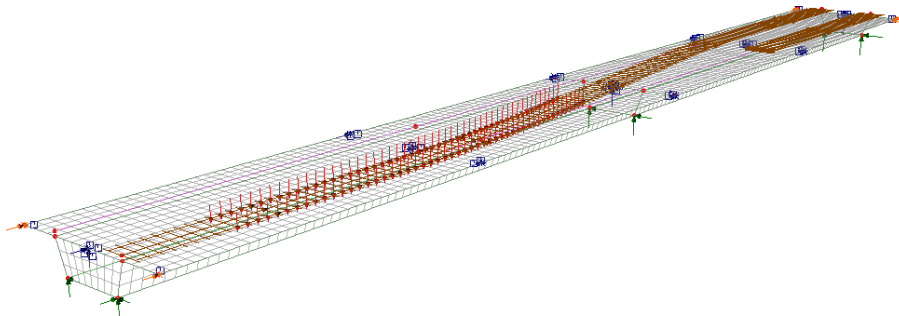

See the [Rail Load Optimisation Wizard](#) for more details.



Train loading visualised



Stage 5: Solve to calculate the effects of train loading on the structure

After running a Rail Load Optimisation analysis the model must be **solved** to calculate the effect of the track loading patterns on the model. Track loading patterns can be optionally visualised, and superimposed on deformed or undeformed results plots.

With influence result loadcases and loadcases representing the critical rail loading patterns present in the Analyses  Treeview, pressing the Solve button  on the main toolbar menu will analyse the effect of these loadings on the structure.

It is also possible to choose the **Solve Now** menu item on context menu of individual analysis entries. Loadcases can also be solved selectively by choosing the **Loadcase to Solve** context menu item.

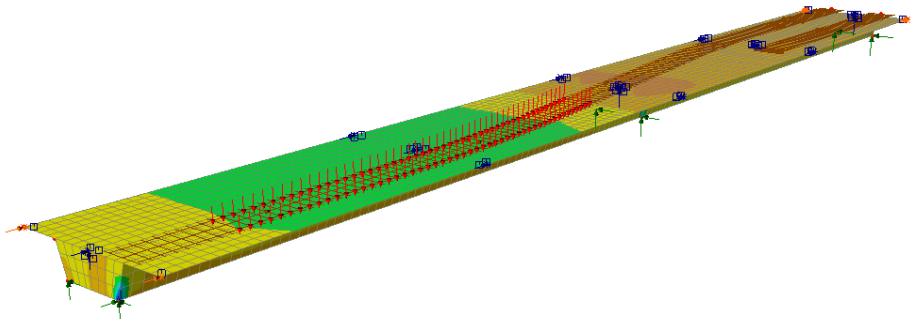

Viewing of rail track loading patterns

- By turning on the display of loading  and setting each loadcase active in the Analyses  Treeview, the rail loading pattern for each loadcase generated by the rail load optimisation wizard can be viewed.
- By expanding each loadcase's loading entry, the individual loading types and their corresponding load factors that make-up each loadcase can be seen. Context menu items provide additional visualisation and other options.



Viewing of effects of train loading on model

Updating and re-running a rail load optimisation analysis

Editing an existing RLO Run  entry in the Layers  Treeview to include more influences will delete and re-create existing influences as well as add new results loadcases for the additional influences. To retain existing results and just add new loadcases, simply add another RLO run.

Superposition

The Rail Load Optimisation facility inherently uses the principal of linear superposition. In a linear static analysis this assumption holds true for all results components that are calculated by a LUSAS Solver, but note that it does not hold true for some results components that are post-processed by LUSAS Modeller. For example, Wood Armer calculations are not linear calculations, therefore superposition is not safe for these. Similarly, the definition of any user-defined results components (that can be used in the definition of a Direct Method influence) may include equations with terms or constants that are not scalable.

Viewing Results

See [Visualising the Results](#).

Rail Load Optimisation Wizard

Rail Load Optimisation is provided for use with selected Bridge software products only, and only for licences that support this facility.

The rail load optimisation wizard can be accessed from the **Analyses > Bridge > Rail Load Optimisation > RLO Run** menu item. It provides the means to define parameters, for a particular design code, in order to generate the most critical train loading arrangement for each influence shape under consideration for a selected track layout. Prior to accessing the Rail Load Optimisation (RLO) wizard to run an RLO analysis [influence attributes](#) must have been assigned to selected nodes or points of interest on a model. A track layout (requiring track definitions) also needs to be defined and selected.

See [Rail Load Optimisation Overview](#) for a general description of how to carry out a rail load optimisation analysis. A [worked example](#) illustrates the steps involved in carrying out rail load optimisation.

Design codes supported by Rail Load Optimisation (LUSAS RLO)

The screenshot shows the 'Railway Load Optimisation' dialog box. It is divided into three main sections: 'Loading options', 'Solution process', and 'Analysis'. In the 'Loading options' section, 'Country' is set to 'Europe' and 'Design code' is 'EN1991-2 Recommended Values 2009'. There are buttons for 'Optional code settings...' and 'Optional loading parameters...'. The 'Solution process' section has a checked box for 'View onerous effects table' and an unchecked box for 'Create loading patterns'. Below this are radio buttons for 'All chosen influences' (selected) and 'Most onerous'. There is a 'Set influence surfaces...' button and a dropdown menu set to 'Upper And Lower Tracks'. The 'Analysis' section has a dropdown for 'Analysis' set to 'RLO Analysis 1' and a text field for 'Name' set to 'RLO Run 1'. At the bottom, there is a note: 'Note that the model will be saved when OK is pressed' and three buttons: 'OK', 'Cancel', and 'Help'.

Country design codes currently supported by the LUSAS Rail Load Optimisation software option include:

- Denmark** - [Eurocode EN1991-2 Denmark 2015](#)
- Europe** - [Eurocode EN1991-2 \(Recommended Values\) 2009](#)
- Finland** - [Eurocode EN1991-2 Finland 2015](#)
- International** - [UIC 776-1-R \(5th Edition\)](#)
- Ireland** - [Eurocode EN1991-2 Ireland 2010](#)
- Italy** - [Eurocode EN1991-2 Italy 2007](#)
- Norway** - [Eurocode EN1991-2 Norway 2016](#)
- Poland** - [Eurocode EN1991-2 Poland 2008](#)
- United Kingdom** - [Eurocode EN1991-2 UK 2009](#)
- United Kingdom** - [NR-GN-CIV-025](#)

Editing of the supplied rail load optimisation design files is not permitted. But a folder containing files for a particular design code may be copied to a specifically named user folder (which is read automatically each time the Rail Load Optimisation dialog is presented), and then be edited as required. Subsequent opening of the RLO dialog will list those user-defined design codes as a 'User' code alongside the LUSAS supplied design codes. For more information, contact LUSAS technical support.

Optional Code Settings

Optional code settings can be specified for all design codes supported. Click on the country links above for each country, see the online help dialogs for each country for details, or refer to the relevant help pages in the *Application Manual (Bridge, Civil & Structural)*.

Optional Loading Parameters

The following parameters are available for selection:

- Longitudinal increment** specifies the increment used when moving the train loading along the track. The smaller the increment, the more accurately the effect of the train loading across the structure is calculated, giving more accurate results. A larger increment gives quicker RLO runs, but with less accuracy. A generally suitable default value is provided, but users can specify an alternative value based upon experience.
- Transverse increment** Not applicable for Rail Load Optimisation since loading is always assigned to rails that are a specified distance apart.
- Vehicle Direction** specifies the direction which is used to calculate the effects of each train on each track. Train axles are defined positively from the last axle to the leading axle.
- Forward** The train loading is moved along a track in a forward direction from the starting point of the track. The start of a track is as defined on the track definition dialog.

- Reverse** The train loading is moved along a track from the starting point of the track, but with the normally trailing axle leading.
- Both** applies both forward and reverse cases. This is the suggested and default choice. For an asymmetric train loading, either forward or reverse could produce the greatest effect, dependent upon the shape of the influence surface and the increments used.

Solution Process Options

Setting-up Influence Surfaces

The **List of available influences** shows all assigned **influence attributes** for the model. These can be included in a rail load optimisation analysis by individual selection or by selecting all. The following additional settings can be made:



- Include all influence surfaces** - selects all the influence surfaces in the model for use in the rail load optimisation.
- Dynamic Factor** (for NR-GN-CIV-025 loading only) is provided if the option "Specify for each influence selected" is chosen from the Optional Code Settings dialog. A different dynamic factor is needed for each influence because it depends on the span length, and on whether the influence is Positive moment, Negative moment, Shear, Bearing reaction,
- L (m)** (for UIC 776-1 only) This is an option to introduce the length (in model units) of the influence used. For use in calculation of the dynamic factor.
- Positive** and/or **Negative** Train loading can be placed on either Positive or Negative areas by checking the Positive or Negative (or both) checkboxes for each of the included influences. Note that clicking in the header cell of a column will select the whole column so that checking (ticking) one entry in the column will check (tick) all entries in that column. Selection of multiple columns is also possible.



Selecting a Track Layout

A pre-defined **track layout** that references **track definitions** must be selected.

Other settings

- View onerous effects table** Shows tabbed and sorted results for all chosen influences at nodes that are visible, with the most onerous result shown in the first row of the table. Displayed results can be filtered by subsequently selecting features or mesh objects of interest. For more information see **Onerous Effects Table** below.
- Create loading patterns** To run a Rail Load Optimisation analysis with optimised loading select this check box, selecting either the **All chosen influences** option, which generates loads and loadcases for all chosen influences; or the **Most onerous** option, where for each influence attribute the loads and loadcases are only generated for the influence assignment that gives

the most onerous effect. For both options, loading entries are created in the Attributes  treeview and an entry is created in the Analyses  Treeview under the corresponding RLO Run. To visualise the loading patterns a loadcase must be set active and appropriate [loading visualisation settings](#) made.

- ❑ The **Analysis** name provided creates an appropriate entry in the Analyses  Treeview. Note that an analysis can contain up to 1000 RLO Runs. Separate user-defined analysis entries can be created to hold different RLO Runs using the 'New' analysis option on the drop-down menu for the Analysis entry, but for speed of solving, note that it is more beneficial to have all RLO Runs contained within one analysis.
- ❑ The Rail Load Optimisation **Name** is used to identify each RLO Run. Short names are recommended since RLO Run names are used to create filenames that also include the influence name and coordinate and element details, and if collectively this is too long, the Windows path limit of 260 characters may be exceeded. See [File and folder naming in LUSAS](#) for details.
- ❑ When the **OK** button is pressed LUSAS will carry out the influence surfaces analysis and carry out a Rail Load Optimisation analysis based on the country design code selected. The results from the analysis will be loaded into the LUSAS model in readiness for the model to be solved using the [Solve Now](#) button on the main toolbar. When the model is solved for the selected track layout, the results from the analysis will be seen in the Rail Load Optimisation  entry in the Analyses  Treeview.

Notes

- For models with numerous influence assignments of the same type, potentially un-necessary load generation can be avoided, and solution time can be saved, by ensuring that 'Create loading patterns' is not selected on the main RLO dialog, to allow for only the most onerous loading patterns to be created from the subsequent RLO onerous results table listings.
- The time taken to evaluate critical rail loading effects for a structure depends upon the design code in use; the type of train loading being applied; the number of tracks present in a track layout; the number of spans; the mesh size; the values used for longitudinal load increments; whether one-way or two-way direction is specified; and the number of influence points to be evaluated. An approximate assessment of the time that will be required to evaluate a particular loading scheme for a large number of influence points can be achieved by initially timing how long it takes for just one influence point to be evaluated and factoring by the number of influences required, but note that for the first time RLO is run, displacement and influence files are generated that will be used by subsequent runs - so subsequent runs will be faster.

Defaults Buttons

- ❑ **Defaults** buttons that are present on the main and many of the associated Rail Load Optimisation dialogs will reset selected parameters and values to their default settings.

Onerous Effects Table

When a RLO analysis is run, a RLO onerous effects table can be optionally displayed which shows sorted results for all chosen influences at nodes that are visible, with the most onerous result shown in the first row of the table. For Direct Method Influences these values are due to train loading for the specified load effect of interest at specified locations on the model. That is, a single value direct from the LUSAS Rail Load Optimisation facility, without the need for a further static solution.



In the onerous effects table a results tab is present for each <**Influence attribute – Sign – Design Case**> group listed. This group is referred to as an 'Influence Design Loadcase'. Load patterns can be created on a case-by-case basis if not already created by means of the 'Create loading patterns' setting on the main RLO dialog.

	Influence Assignment	Node	Mx	Caused by	Create loading
1	Point 8 - (Surface 1)	127	224.859	HL93	Loading created
2	Point 8 - (Surface 2)	127	224.775	HL93	Create loading
3	Point 11 - (Surface 3)	113	224.15	HL93	Create loading
4	Point 11 - (Surface 2)	113	224.112	HL93	Create loading
5	Point 12 - (Surface 3)	10	206.304	HL93	Create loading
6	Point 12 - (Surface 2)	10	206.037	HL93	Create loading
7	Point 7 - (Surface 1)	23	205.848	HL93	Create loading
8	Point 7 - (Surface 2)	23	205.667	HL93	Create loading
9	(10.5074, 79.8113, 0.0) - (Element 57)	82	189.14	HL93	Create loading
10	(10.5074, 79.8113, 0.0) - (Element 77)	82	189.139	HL93	Create loading
11	(10.5074, 79.8113, 0.0) - (Element 75)	82	188.912	HL93	Create loading
12	(10.5074, 79.8113, 0.0) - (Element 60)	82	188.8	HL93	Create loading

On each results page, the following column headings are present:

- ❑ **Influence Assignment** The location (coordinate and feature/object type) of the assigned DMI attribute.
- ❑ **Node** The node at which the assignment was made. Note that the **Find** context menu option for the cells in this column will, when clicked, highlight the corresponding node in the model View window by animating concentric shrinking squares. This easily identifies the assignment location.
- ❑ **'Chosen results effect'** For Direct Method Influence, this column is named after the result entity component selected in the DMI attribute (e.g. Mx, Fz,





etc); the values in this column show the effect of the train loads at locations of interest.

- ❑ **Caused by** states the name of the loading type which produced the most onerous effect.
- ❑ **Create loading** Creates loading entries in the Attributes  Treeview and a loadcase in the Analyses  Treeview that cause the onerous effect listed.

If the option to ‘Create loading patterns’ was chosen on the main RLO dialog, Loading folders will additionally appear for each influence loadcase added to the Analyses  Treeview, and the RLO results table will show ‘Loading created’ alongside all influence assignment entries. If ‘Create loading patterns’ was not selected on the main RLO dialog the most onerous loading effects can be created individually by using the ‘Create Loading’ button that appears instead of the ‘Loading Created’ one.

For the influences where no loading is produced by LUSAS RLO (because for the specified location there aren’t any loads that can be placed to produce an adverse effect), the ‘Chosen results effect’ and ‘Caused by’ cells will be empty.

Viewing, filtering and saving onerous effects tables

RLO onerous effects results tables can be re-displayed for all influences at any time by selecting the **View table results...** context menu for a RLO Run  entry in the Analyses  Treeview. A table for a single particular influence can be created by double-clicking on the relevant onerous results table  entry in the Analyses  Treeview.

Results displayed in the tables can be filtered by selecting features or mesh objects of interest in the view window. So, for instance, with table results displayed in one view window, it is possible to select a line representing a span in a bridge in the model view window and have the results table only display the results for the nodes in the elements within that line. Similarly it is possible to select a surface representing a span of a slab and view only the results for the nodes in the elements within that surface. Use the Window > Layout > Multiple documents menu item and the Window > Tile facility to see the onerous results table data and model view window side-by-side. Column data can be sorted by clicking on column headers.

Table results for an active table can be saved to a spreadsheet using the **File > Save as Microsoft Excel** menu item.

Usage

Once the onerous effects for each ‘Influence Design Loadcase’ have been obtained, and if the option to ‘Create loading patterns’ was not chosen on the main RLO dialog, the corresponding loading will need to be created on a case-by-case basis, if not already done. Whilst generated loading patterns can be visualised, results are available only after the RLO analysis has been solved. Once solved, the resulting loadcases should be combined with self weight and factored accordingly to create design combinations.

Worked examples

- See Online help > Worked Examples > For LUSAS Bridge and LUSAS Civil & Structural > 'Example Title'.

Track Definition

The track definition dialog is accessed by using the **Bridge> Rail Track Optimisation > Track Definition** menu item.

Track definitions are used by rail **track layouts** to specify particular track loading scenarios for use with the **Rail Load Optimisation** facility.

The dialog allows the centrelines of lengths of track to be defined:

- By coordinates**
- By copying and pasting data from a spreadsheet**
- By selecting lines and arcs that are added to the LUSAS model to represent track centrelines.** This is perhaps the most commonly used method.

For any method, the transverse distance between rail loads on the track must also be stated.

Once defined a track is shown on the model by the drawing of non-selectable lines that represent the rails and sleepers. The rail track definition is stored and viewed in the Utilities  Treeview. Like other utilities, track definitions are not directly assignable to geometry and can only be edited using this dialog.

Notes

- Lines used to define a centreline of a track should lie in a common plane.
- If desired, the lines defining the centreline of a track can be defined to lie above a model rather than be defined in the same plane as the surfaces on which the rail loading will be applied.
- Bridge decks with a variable longitudinal vertical profile (such as a vertically curved deck) must be modelled 'flat' in a primary (X,Y), (Y,Z) or (Z,X) plane.
- For bridge decks with a constant longitudinal vertical profile (such as a horizontal or inclined bridge deck) the lines representing a track centreline may lie in a primary plane or in the same plane as the bridge deck.

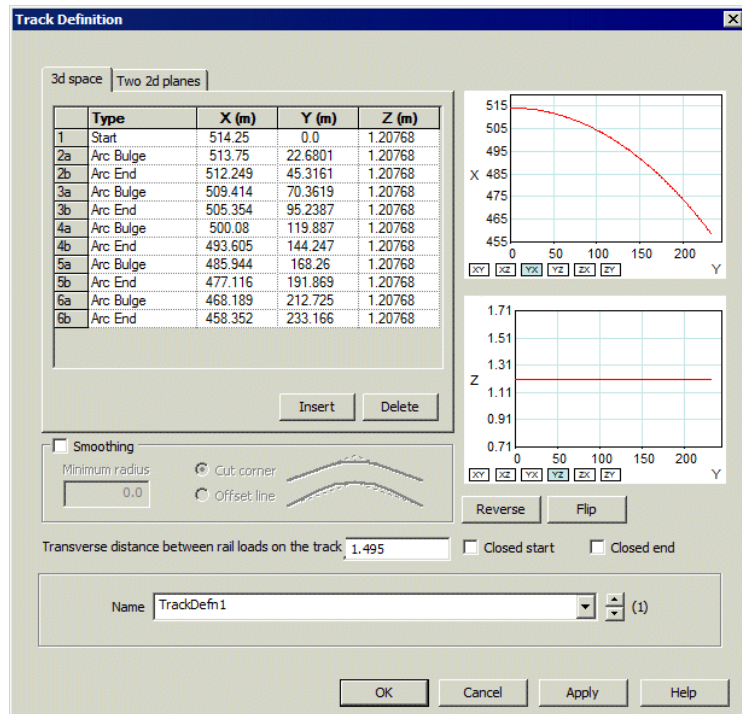

Defining the centreline of a track by coordinate input

The centreline of a track can be defined by adding rows to a table and specifying the coordinates of each defining point along the path. Values are entered in global coordinates. As the coordinates are entered the centreline of the track that they define is visualised in the adjacent graphs.

- ❑ **Type** Clicking on the drop-list button in this cell of the table allows the type of line to be specified. Options are Straight, Arc Bulge, Arc Centre, and Parabola Bulge.
- ❑ **Insert, Delete and Reverse** buttons provide the means to create a new row above a selected row, to delete selected rows, and to reverse the order of all of the rows in the table. Use the tab key to create a new row at the bottom of the table.

The definition grid shows track geometry and allows specification of line segment type when a reference path has been generated using lines or arcs in Modeller. Splines are not supported.

Defining the centreline of a track by spreadsheet import

The geometry and line segment information that defines the centreline of a track can be imported from a spreadsheet using standard copy and paste facilities. Both four column (type and coordinate data) and three column (coordinate data only) widths are supported. With four column import the data in the first column is expected to be text. Three column data is expected to be numeric and will paste into the coordinate cells wherever it is pasted. Selecting the top left row / column box allows copying and pasting of data from a spreadsheet using Ctrl + C and Ctrl + V keyboard shortcuts.

Defining the centreline of a track from line and arc features

Lines and arcs which represent the centreline of a track can be defined in LUSAS Modeller and then be selected prior to accessing this dialog. Line segments along the path will then be listed in the table with their setting-out information. The order of the segments selected will determine the start point and direction of the track definition. Note that lines defining track centrelines do not have to be meshed, or form a structural part of the model.

Smoothing

Smoothing allows the definition of a minimum radius around or through which two intersecting line segments will be shaped. There are two options:

- Cut corner** adds a radius transition between two lines inside of their defined intersection point.
- Offset line** adds a radius transition between two lines through their defined intersection point.

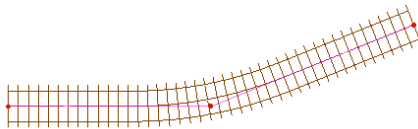

Cut corner

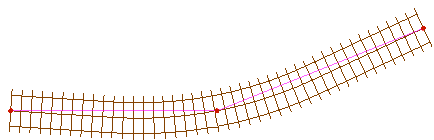

Offset line

Transverse distance between rail loads on the track

The transverse distance between rail loads to be applied to the track must be specified. A default value is provided.

Restricting loading to specific locations along a track

By default, rail loads will be applied to a length of track in a track definition to cause the worst-case effect on that track. This means that rail loads may be placed either before

and/or after the extent of the track defined. To restrict rail loading to start or finish at the start or end of a track (to either signify buffers preventing any rail loading from being applied beyond the point, or to signify a location along the track where a train has to stop at a signal), two options are provided:

- Closed start** Train rail loading will be positioned starting at this location on the track.
- Closed end** Train rail loading will be positioned ending at this location on the track.

A closed start or a closed end is represented by the drawing a thickened line for the sleeper at that location.

For example:

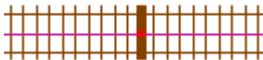

The direction of the line defining the centreline of the track determines where the closed start or end applies.

Examples of track definitions

Lines or arcs must be defined for each length of track that is to be considered for inclusion into a track layout. Depending upon the track loading configurations to be assessed, multiple sections of track may be required to be represented by multiple lines, rather than model a single length of track with one line. As a hypothetical example, consider the track arrangement below, for which the point and line geometry which has been set-up to carry out rail load optimisation for the following three track layout scenarios:

1. Trains running along the full length of the upper and lower tracks
2. A train passing from the lower track onto the upper track, whilst a train waits at a location (shown by the thickened line) on the lower track
3. Trains waiting at separate locations (shown by the thickened lines) on both the upper and lower tracks

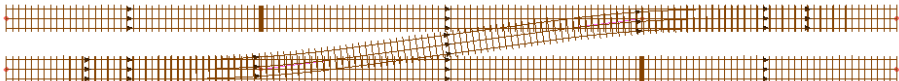

Loadable track arrangement to be modelled

Separate lines need to be defined for each section of track that is to be included into a track layout. This means that three lines are needed to represent the length of the upper track, three lines are needed to represent the length of the lower track, and a single line can represent the cross-over. From this geometry, and by making appropriate line selections, the following five track definitions can be created:

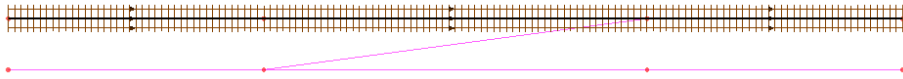

Track definition: Upper Track Only
(all three lines selected)

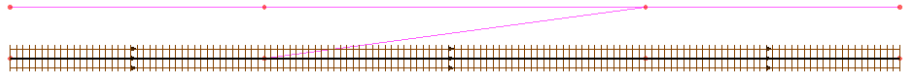

Track definition: Lower Track Only
(all three lines selected)

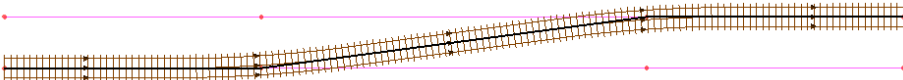

Track definition: Crossover Track
(three lines selected and a cut corner smoothing radius applied)

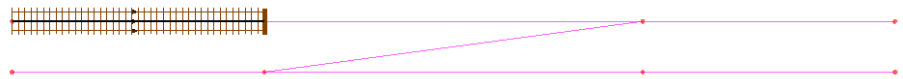

Track definition: Upper Track with a Closed End
(one line selected)

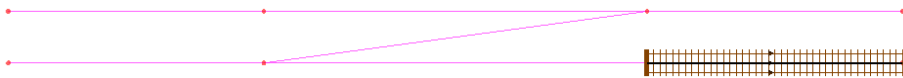

Track definition: Lower Track with a Closed Start
(one line selected)

Track definitions are used in defining viable **track layouts** in order for a Rail Load Optimisation analysis to be carried out.

Visualisation of track definitions

By default, track definitions are drawn using lines that represent the rails and sleepers. Direction arrows at mid-points along each line segment, show the direction of the

track definition. Each Track definition entry in the Utilities  Treeview has a context menu enabling the following selections:

- Rename** changes the track definition name
- Delete** removes the track definition entry from the Utilities treeview but the menu item is only available if a track definition has not been associated with a geometric line assignment.
- Edit** displays the track definition dialog to enable changes to be made
- Visualise** is a toggle setting that turns on and turns off the visualisation of a track.

Notes

- Track definitions can be selected by centreline or by the drawn lines that represent the rails.
- The underlying line direction determines whether a closed start or a closed end should be specified for lengths of track that require this to be stated.
- Modifying a track definition that is used in a rail track layout will invalidate the results of that analysis resulting in an invalid results symbol (a red circle with a line through it)  appearing alongside any influence results loadcases in the Analyses treeview, requiring a re-solve to be done.
- It is not possible to delete a track definition if it has been included in a track layout. It must be removed from the track layout prior to deletion.
- Lines defining track centrelines can be held in groups and made invisible to clarify the display of the model, but note that separate visualisation controls govern the visibility of the tracks themselves.

Track Layouts

The rail track layout dialog is accessed by using the **Bridge> Rail Track Optimisation > Railway Track Layout** menu item.

A track layout defines which **track definitions** can be loaded in a single run of a **Rail DMI analysis**. Multiple track layouts can be defined by including and excluding track definitions and changing the track layout name before pressing the **Apply** button on the dialog each time. Examples of track layouts are shown below.

Rail track layouts created using this dialog are added as entries within a Rail Track Layout folder in the Utilities  Treeview. Like other utilities track layouts are not directly assignable to geometry and can only be edited using this dialog.

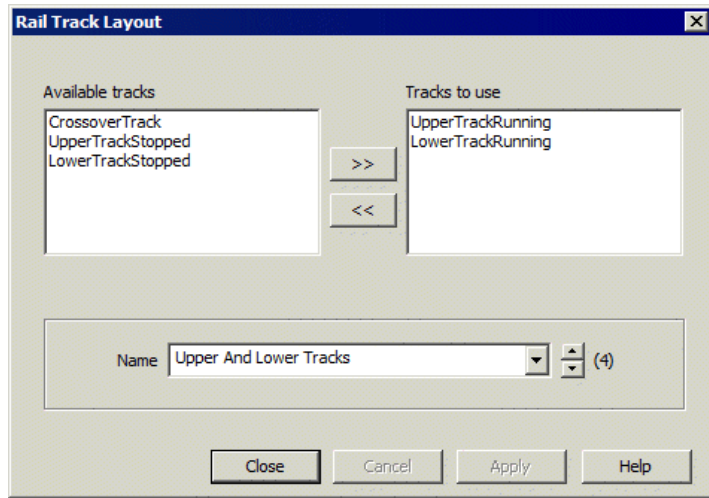

Examples of track layouts

For five example [track definitions](#) ('Upper Track', 'Lower Track', 'Crossover Track', 'Upper Track Stopped' and 'Lower Track Stopped') the following three representative track layouts can be set-up for use with the Rail Load Optimisation facility.

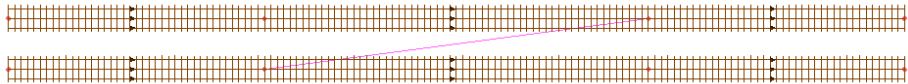

Track Layout: Upper and Lower Tracks

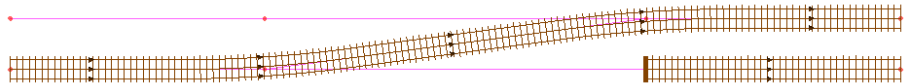

Track Layout: Crossover Track and Lower Tracked Stopped

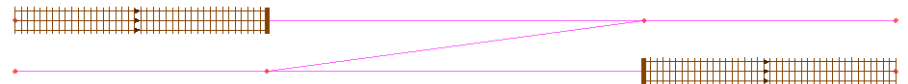

Track Layout: Upper and Lower Track Stopped

Visualisation of track layouts

Each track layout entry in the Utilities  Treeview has a context menu enabling the following selections:

- Rename** changes the track layout name.
- Delete** removes the track layout entry from the Utilities treeview.
- Edit** displays the track definition dialog to enable changes to be made.
- Visible** turns on the display of a track layout.
- Invisible** turns off the display of a track layout.

Notes

- Modifying a track definition that is used in a rail track layout will invalidate the results of that analysis resulting in an invalid results symbol (a red circle with a line through it)  appearing alongside any influence results loadcases in the Analyses treeview, requiring a re-solve to be carried out.
- It is not possible to delete a track layout if it has been referenced by a Rail Direct Method Influence analysis.

EN1991-2:2003 Optional Code Settings

This design code loading is supported by the LUSAS Rail Load Optimisation software option.

Selecting **Europe > (Design Code)** on the main Rail Load Optimisation dialog sets default values according to the following National Annexes and Recommended Values:

- Denmark - DS/EN 1991-2 DK NA:2015 National Annex to Eurocode 1:**
Actions on Load-carrying Structures Part 2: Traffic Loads on Bridges
BaneDanmark/ Vejdirektoratet, 1 May 2015 / DS/EN 1990/A1 DK NA:2015
National Annex to Eurocode 0: Basis of structural design, Annex A2
Applications for Bridges BaneDanmark/ Vejdirektoratet, 1 May 2015
- Finland - KANSALLINEN LIITE (LVM) STANDARDIIN SFS-EN 1991-2 EUROKOODI 1: RAKENTEIDEN KUORMAT Osa 2: Siltojen liikennekuormat LIIKENNE- JA VIESTINTÄMINISTERIÖ 1.6.2010 / KANSALLINEN LIITE (LVM) SFS-EN 1990:2002/A1 (Liite A2) RAKENTEIDEN SUUNNITTELUPERUSTEET Muutos A1: Liite A2: Soveltaminen siltoihin LIIKENNE- JA VIESTINTÄMINISTERIÖ 9.1.2015**
- Ireland - NA to IS EN 1991-2:2003 (Irish) National Annex to Eurocode 1:**
Actions on structures – Part 2: Traffic loads on bridges. NSAI, Dublin, Sept 2009 / NA to IS EN 1990:2002+A1;2005 (Irish) National Annex to Eurocode – Basis of structural design. NSAI, Dublin, March 2010

- ❑ **Italy** - UNI-EN-1991-2-2 Eurocodice 1 - Azioni sulle strutture - Parte 2 - Carichi da traffico sui ponti. 27 luglio 2007 / UNI-EN-1990 - Criteri generali di progettazione strutturale - Appendice A2 - Applicazioni ai ponti. 27 luglio 2007
- ❑ **Norway** - NS-EN 1991-2:2003 NA 2010 Eurokode 1: Laster på konstruksjoner - Del 2: Trafikklast på bruer / NS EN 1990-2002 A1 2005 NA 2016 Eurokode: Grunnlag for prosjektering av konstruksjoner
- ❑ **Poland** - PN-EN 1991-2:2007 Eurokod 1: Oddziaływania na konstrukcje - Część 2: Obciążenia ruchome mostów, PKN Warszawa 2007
- ❑ **Recommended Values** - EN1991-2:2009.
- ❑ **United Kingdom - Eurocode EN1991-2 - NA to BS EN1991-2:2003** incorporating Corrigendum No. 1, UK National Annex to Eurocode 1: Actions on structures – Part 2: Traffic loads on bridges. British Standards Institution, Chiswick, May 2008 / NA to BS EN 1990:2002+A1;2005 incorporating National Amendment No. 1, UK National Annex for Eurocode – Basis of structural design. British Standards Institution, Chiswick, June 2009

National annexes supported can also be accessed by selecting a country name prior to selecting the design code.

Classification and other factors, and default settings for other supported National Annexes are automatically set on the Optional Code Settings dialog according to the National Annex chosen. Refer to the relevant National Annex clauses and tables for these. User-defined values and settings may alternatively be specified.

The Optional Code Settings dialog allows defining the design situation and limit state that is required, along with Load Models that are to be considered. Factors used in the calculations may be viewed and modified by accessing the [Advanced Settings](#) dialog. This help topic describes settings and options available for Recommended Values only and quotes relevant clauses and tables for this setting.

Design situation and limit state

- ULS Characteristic (Set B)** Leading and Accompanying actions are defined by EN1990-2002 Table A2.4(B).
- ULS Characteristic (Set C)** Leading and Accompanying actions are defined by EN1990-2002 Table A2.4(C).
- SLS Characteristic** Leading and Accompanying actions are defined by EN1990-2002 Table A2.6.
- SLS Frequent** Leading and accompanying actions are defined by EN1990-2002 Table A2.6.

Load Models to consider

- LM71** loading is defined in EN1991-2:2003 Clause 6.3.2. If this option is unchecked, relevant Load Patterns are excluded.
- SW/0** loading is defined in EN1991-2:2003 Clause 6.3.3. If this option is unchecked, relevant Load Patterns are excluded.
- SW/2** loading is defined in EN1991-2:2003 Clause 6.3.3. It only applies to one track, with LM71 or SW/0 applied to any other loaded tracks. These accompanying loads can be optionally included using the checkboxes. Relevant Load Patterns are excluded when options are unchecked.

- Unloaded train** loading is defined in EN1991-2:2003 Clause 6.3.4. If this option is unchecked, the relevant Load Pattern is excluded.

Tracks

The maximum number of tracks in a track layout that can be loaded can be set as '1', '2' or 'Unrestricted'. This option specifically provides the means to investigate whether the effect of loading only one track is more onerous than loading three tracks with reduced load factors. Note also that the number of tracks loaded is also separately restricted by the number of tracks defined for the optimisation. If '1' or '2' is selected then Load Patterns which load more tracks will be excluded.

Factors

- Classification factor α for LM71 and SW/0** This is defined in EN1991-2:2003 Clause 6.3.2(3), and can be any of the following: 0.75, 0.83, 0.91, 1.00, 1.10, 1.21, 1.33, 1.46. The default value is 1.00.
- Calculate dynamic factor, ϕ , using** if selected, calculates the dynamic factor from the mutually exclusive pairs of options below:
 - $L\phi$ from each influence selected** (default), if selected, then in the influence dialog, each influence will need to be assigned a value for $L\phi$.
 - Single $L\phi$ for all influences** (in model units).
 - The choice of “Carefully maintained track” or “Standard maintenance” affects which equation from EN1991-2:2003 Clause 6.4.5.2 is used.
 - Enter dynamic factor, ϕ** A value used for all influences. In accordance with EN1991-2:2003 Clause 6.4.5.2(2)(b) it must be a minimum of 1.0 and a maximum of 2.0

EN1991-2 Optional Code Settings (Advanced)

The Optional Code Settings Advanced dialog is used to view and modify factors associated with LM71, SW/0 and SW/2 load models.

Values, factors, and default settings are automatically provided for each supported National Annex. User-defined values and settings may alternatively be specified.

A representative dialog is shown for EN1991-2 Recommended Values.

EN1991-2 Recommended Values 2009 Advanced Settings

Optional parameters

- Allow eccentric loading on each track (for LM71 and SW/0)
- Change multiple presence factors
- Change multi-component factors, ψ

	LM71, SW/0 SW/2	Unloaded train
ULS Characteristic Leading	<input type="text" value="1"/>	
ULS Characteristic Accompanying	<input type="text" value="0.8"/>	<input type="text" value="1"/>
SLS Characteristic Leading	<input type="text" value="1"/>	
SLS Characteristic Accompanying	<input type="text" value="0.8"/>	
SLS Frequent Leading	<input type="text" value="0.8, 0.7, 0.6"/>	

Partial factors

- Change partial factors

	LM71, SW/0	SW/2	Unloaded train
ULS (Set B)	<input type="text" value="1.45"/>	<input type="text" value="1.2"/>	<input type="text" value="1.45"/>
ULS (Set C)	<input type="text" value="1.25"/>	<input type="text" value="1.25"/>	<input type="text" value="1.25"/>
SLS	<input type="text" value="1"/>	<input type="text" value="1"/>	

Defaults OK Cancel Help

Optional parameters

- Allow eccentric loading on each track (for LM71 and SW/0)** EN1991-2:2003 Clause 6.3.5 requires “any one track” of LM71 or SW/0 to be split in the ratio of 1.25:1 between the two rails. As implemented, the wording “any one track” is taken that only one track from all of the tracks will have eccentric loading. The factor can be user-defined, or turned-off (in which case a factor of 1 will be used).
- Change multiple presence factors** A factor of 0.75 when three or more tracks are loaded is defined in EN1991-2:2003 clause 6.8.1(4) and (5) and Table 6.11. The factor can be user-defined, and similar factors can be stated using a comma separated listing format for the cases of one track loaded or two tracks loaded.

- Change multi-component factors, ψ** Multi-component factors are defined in EN1990:2002 Table A2.3.

Partial factors

- Change partial factors** Partial load factors for ULS and SLS load models are defined in EN1991:2003 Tables A2.4(B) and A2.4(C).

The **Defaults** button resets all entered values to their default settings.

UIC 776-1-R Optional Code Settings

This design code loading is supported by the LUSAS Rail Load Optimisation software option.

Selecting **International > UIC 776-1-R** on the main Rail Load Optimisation dialog sets default values according to:

- **UIC 776-1-R (5th Edition)**

The Optional Code Settings dialog allows defining the design situation and limit state that is required, along with Load Models that are to be considered. Factors used in the calculations may be viewed and modified by accessing the [Advanced Settings](#) dialog.

The screenshot shows the 'UIC Test' dialog box with the following settings:

- Design situation and limit state:**
 - ULS Characteristic: Leading, Accompanying
 - SLS Characteristic: Leading, Accompanying
 - SLS Frequent: Leading
- Load models to consider:**
 - LM71
 - SW/0
 - SW/2
 - Accompanying LM71
 - Accompanying SW/0
 - Unloaded train
- Tracks:**
 - Maximum number of tracks loaded: Unrestricted
- Factors:**
 - Classification factor, α for LM71 and SW/0 loads: 1.0
 - Calculate dynamic factor, ϕ , using:
 - $L\phi$ from each influence selected
 - Single $L\phi$ for all influences [] m
 - Carefully maintained track
 - Standard maintenance
 - Enter dynamic factor, ϕ []

Buttons: Defaults, OK, Cancel, Help

Design situation and limit state

- ULS Characteristic Leading and Accompanying actions are defined by UIC Leaflet 776-1 Appendix A.

- SLS Characteristic Leading and Accompanying actions are defined by UIC Leaflet 776-1 Appendix A.
- SLS Frequent Leading and Accompanying actions are defined by UIC Leaflet 776-1 Appendix A.

Load Models to consider

- LM71** loading is defined in UIC Leaflet 776-1 clause 2.3.2. If this option is unchecked, relevant Load Patterns are excluded.
- SW/0** loading is defined in UIC Leaflet 776-1 clause 2.3.3. If this option is unchecked, relevant Load Patterns are excluded.
- SW/2** loading is defined in UIC Leaflet 776-1 clause 2.3.3. As per clause 2.8.1 it only applies to one track, with LM71 or SW/0 applied to any other loaded tracks. These accompanying loads can be optionally included using the checkboxes. Relevant Load Patterns are excluded when options are unchecked.
- Unloaded train** is defined in UIC Leaflet 776-1 clause 2.3.4. If this option is unchecked, the relevant Load Pattern is excluded.

Tracks

The maximum number of tracks in a track layout that can be loaded can be set as '1', '2' or 'Unrestricted'. This option specifically provides the means to investigate whether the effect of loading only one track is more onerous than loading three tracks with reduced load factors. Note also that the number of tracks loaded is also separately restricted by the number of tracks defined for the optimisation. If '1' or '2' is selected then Load Patterns which load more tracks will be excluded.

Factors

- Classification factor α for LM71 and SW/0** This is defined in clause UIC Leaflet 776-1 clause 2.3.2 and can be any of the following: 0.75, 0.83, 0.91, 1.00, 1.10, 1.21, 1.33, 1.46. The default value is 1.00.
- Calculate dynamic factor, ϕ , using** if selected, calculates the dynamic factor from the mutually exclusive pairs of options below:
 - $L\phi$ from each influence selected** (default), if selected, then in the influence dialog, each influence will need to be assigned a value for $L\phi$.
 - Single $L\phi$ for all influences** (in model units).
 - The choice of “Carefully maintained track” or “Standard maintenance” affects which equation from UIC Leaflet 776-1 Clause 2.4.2.2 is used
 - Enter dynamic factor, ϕ** A value used for all influences. In accordance with UIC Leaflet 776-1 clause 2.4.2.2 it must be a minimum of 1.0 and a maximum of 2.0

UIC776-1 Optional Code Settings (Advanced)

The Optional Code Settings Advanced dialog is used to view and modify factors associated with LM71 and SW/0 load models .

Optional parameters			
<input checked="" type="checkbox"/>	Allow eccentric loading on each track (for LM71 and SW/0)	1.25:1	
<input type="checkbox"/>	Change multiple presence factors	1, 1, 0.75	
<input type="checkbox"/>	Change multi-component factors, ψ		
		LM71, SW/0 SW/2	Unloaded train
	ULS Characteristic Leading	1	
	ULS Characteristic Accompanying	0.8	1
	SLS Characteristic Leading	1	
	SLS Characteristic Accompanying	0.8	
	SLS Frequent Leading	0.8, 0.7, 0.6	
Partial factors			
<input type="checkbox"/>	Change partial factors		
		LM71, SW/0	SW/2
			Unloaded train
	ULS	1.45	1.2
	SLS	1	1

Optional parameters

- Allow eccentric loading on each track (for LM71 and SW/0)** UIC Leaflet 776-1 clause 2.3.5 requires “any one track” of LM71 or SW/0 to be split in the ratio of 1.25:1 between the two rails. The wording “any one track” is interpreted that only one track from all of the tracks will have eccentric loading. The factor can be user-defined, or turned-off (in which case a factor of 1 will be used).
- Change multiple presence factors** A factor of 0.75 when three or more tracks are loaded is defined in UIC Leaflet 776-1 clause 2.8.1. The factor can be user-defined, and similar factors can be stated using a comma separated listing format for the cases of one track loaded or two tracks loaded.
- Change multi-component factors, ψ** Multi-component factors are defined in UIC Leaflet 776-1 Appendix A Table 2.

Partial factors

- Change partial factors** Partial load factors for ULS and SLS load models are defined in UIC Leaflet 776-1 Appendix A Table 2.

The **Defaults** button resets all entered values to their default settings.

NR-GN-CIV-025 Optional Code Settings

This design code loading is supported by the LUSAS Rail Load Optimisation software option.

Selecting **United Kingdom > NR-GN-CIV-025** on the main Rail Load Optimisation dialog sets default values according to:

- **NR-GN-CIV-025, THE STRUCTURAL ASSESSMENT OF UNDERBRIDGES, Network Rail.**

The Optional Code Settings dialog allows defining the rail traffic loads, dynamic factor for selected influences and track factors to be applied to RA loading or wagons.

Load Models to consider

- RA loading** is defined in NR/GN/CIV/025 Issue 3 clause 4.3.1.1. As per clause 4.3.1.1 and Table 4.3, the weight of the applied RAI loading may be chosen to be in the range RA1 to RA15; by default, RA10 is selected. A 'Train' or 'Short lengths' configuration (defined in 4.3.1.2) can be included or excluded. If both are included, for each track the most onerous configuration (train or short length) will be selected. Un-checking 'Train' or 'Short lengths' excludes the appropriate rail load from the Load Pattern.
- Assessment load wagon** is defined in clause 4.3.1.4. In accordance with clause 4.3.1.7, this load can be applied in a convoy of unlimited length by checking the 'Include convoy' checkbox.
- Wagon type D4** is defined in clause 4.3.1.5. This load can be applied in a convoy of unlimited length by checking the 'Include convoy' checkbox.

Note: According to clause 4.3.1.7, “Type RAI... loading should be applied as a single unsplit loading or train to each track extending over a length such as to produce the maximum effect in the part of the element being considered”, which, strictly, seems to indicate that intermittent application of the trailing 65kN/m UDL in Figure 4.1 is not required. As implemented in LUSAS, the UDL part of the RA loading is applied intermittently, behind the vehicle, wherever there are adverse areas; providing a more conservative approach.

Dynamic factor

Clause 4.3.2 sets out the rules for calculation of a dynamic factor, which depends on the type of influence (bending or shear), type of member (longitudinal and transverse), span length, etc. An appropriate factor should be specified for all the selected influences.

- Specify for all influences selected** Clause 4.3.2 sets out the rules for calculation of a dynamic factor, which depends on the type of influence (bending or shear), type of member (longitudinal and transverse), span length, etc. An appropriate factor should be specified for all the selected influences.
- Specify for each influence selected** If selected, a 'Dynamic Factor' column will be included on the 'Set Influences' dialog, permitting the setting of a factor for each included influence.

Track factor

Clause 4.3.8 states that “All the assessments should, in the first instance, be undertaken without application of the track factor..” - so track factors are not applied by default.

For RAI loading, clause 4.3.8 states: “the second and subsequent tracks may be assumed to be loaded to 75% of the maximum value”. But for other load types it is stated that “the factor varies with ‘loaded length’”; but since each track could have a different loaded length and all the tracks should have only one factor, no reasonable interpretation could be made for this implementation to automate the calculation of

this factor, therefore the track factor needs to be defined manually for Assessment Load Wagon and Wagon Type D4 load types.

- Apply to RA loading** Define factor. A default value of 0.75 is provided.
- Apply to wagons** Define factor. A default value of 0.75 is provided.

Design Combinations

Overview

The Design Load Combination wizard is accessed from the **Analyses > Design Combinations...** or **Design > Design Combinations...** menu items. It is available in Bridge and Civil software products only. Design combinations are generated by the wizard based on the assignment of design code specific load types. These load types are used to apply the correct factors for the limit state selected.

To define general (non-design code related) load combinations and envelopes see [Basic and Smart Combinations, and Envelopes](#)

Codes of Practice supported

Design combinations for the following codes of practice are supported:

- [AASHTO 8th Edition](#)
- [AASHTO 7th Edition](#)
- [AS/NZS 1170](#)
- [BD21/01](#)
- [BD37/01](#)
- [CSA-S6-14](#)
- [EN1990 \(Buildings\) to Finland National Annex](#)
- [EN1990 \(Buildings\) to Ireland National Annex](#)
- [EN1990 \(Buildings\) to Italy National Annex](#)
- [EN1990 \(Buildings\) to Norway National Annex](#)
- [EN1990 \(Buildings\) Recommended Values](#)
- [EN1990 \(Buildings\) to Sweden National Annex](#)
- [EN1990 \(Buildings\) to UK National Annex](#)
- [EN1990 \(Bridges\) to Ireland National Annex](#)
- [EN1990 \(Bridges\) Recommended Values](#)

- EN1990 (Bridges) to UK National Annex
- GB 50009 - 2012
- JTG D60-2004

For more information see [Design Combinations](#)

Design Code selection and combination options

After selecting a design code, each loadcase that is to be used in the design combination should be assigned a pre-defined load type prior to accessing the combination options page of the design combination wizard. Note that multiple assignments of the same loadtype can be assigned by selecting the first occurrence of the loadcase name, holding-down the Shift key, and then clicking in the load Type cell of the last occurrence of the loadcase name to be assigned the same load type. The load type for all selections can then be selected from the drop-down list of those available.

Combination options relating to the selected design code also need to be specified. An option to choose the combination approach using either basic or smart combinations can be selected. Note that the load factors are included in the combination name for a basic combination but this is not done for a smart combination due to the variable nature of the factors. An envelope can also be optionally created for each combination type.

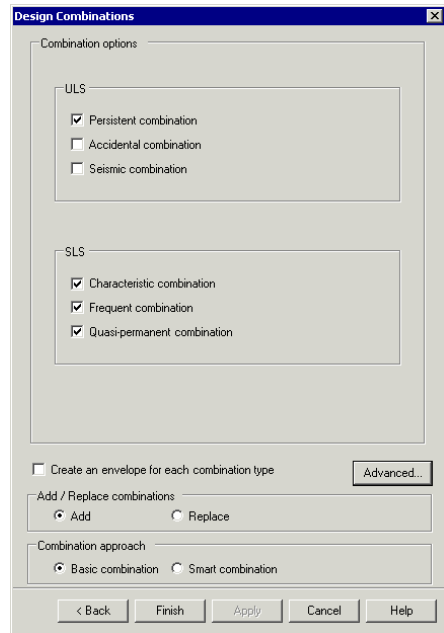
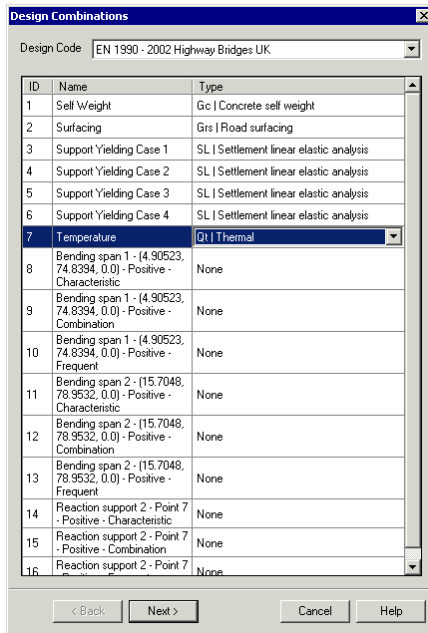

Representative design combination wizard page 1 Representative design combination wizard page 2

Where design combinations are to be used along with design code checking facilities, such as **RC slab design** or **Steel Frame Design**, it is recommended that basic combinations are used.

When re-running the Design Combination wizard it is possible (depending upon settings made) to add new combinations to those already present in the Analyses Treeview, or to replace (remove) all combination entries present with the currently defined ones.

Advanced options

The Advanced options dialog provides an editable listing of the load types and the associated factors to be considered. Load types are separated into Permanent actions and Variable actions. Factors for table entries can be edited. Load types can also be set to be mutually exclusive, or not. When mutually exclusive is set to 'Yes' loadcases that have the same load type assigned are accommodated, but these loadcases are not included in a combination simultaneously.

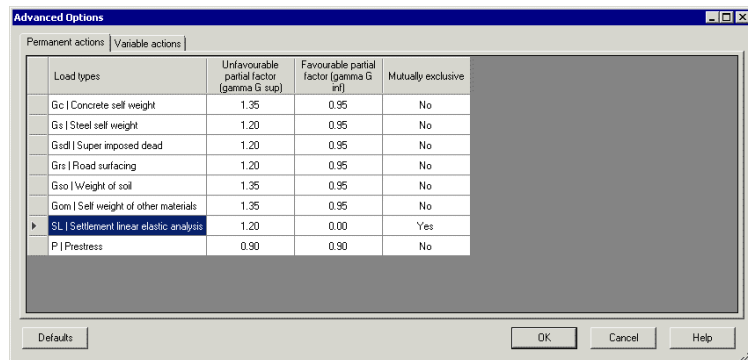

On completion

On completion, separate Design Combination parent folders are created for Basic and Smart Combinations in the Analyses Treeview, containing folders holding (using the Eurocode as an example) the SLS Characteristic, SLS Frequent, SLS Quasi-permanent, and ULS Persistent (Eq 6.10) load combinations.

A Max and Min envelope of the relevant loads may also be created inside each combination folder if this option is selected.

In the case of a smart combination a Constituents folder is also created if there are load types that are to be considered at the same time.

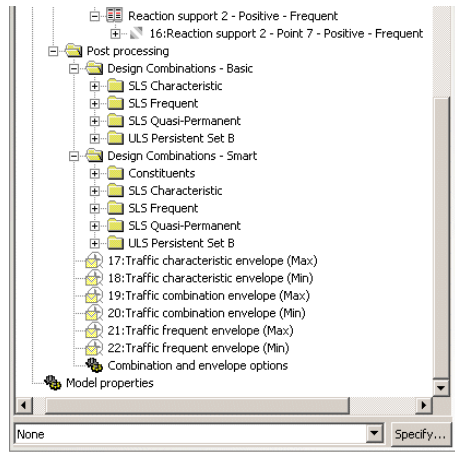

Viewing results

Results are always visualised for the active loadcase. To make a loadcase active right-click on the loadcase in the Analyses Treeview, and choose **Set Active** from the context menu.

See [Visualising the results from Combinations and Envelopes](#) for general notes regarding viewing results.

Note

The design combination wizard is particularly intended for use with results output from the [LUSAS Vehicle Load Optimisation](#) facility. For the bridge design codes supported by LUSAS Traffic Load Optimisation, suitable loadcases can be created with appropriate lane factors and loading arrangement and an appropriate load type can be assigned to each loadcase. Depending upon the loading code used the load factor may be applied in the Vehicle Load Optimisation facility, negating the need to apply a factor in the Design combination wizard. As an example, in the case of the Eurocode, loadcases would need to be created for the characteristic, combination, frequent and quasi permanent combinations with the ψ factors applied to them in the VLO but the load factor γ_Q is not assigned.

Worked example

- See Online help > Worked Examples > For Design Option > 'Bridge Design Load Combinations'.

Design Combination Options - AASHTO LRFD 8th

Create load combinations for:

- Deformations
- Other effects
- Both deformation and other effects

Combination options

- Strength** combinations as per Table 3.4.1-1, Table 3.4.1-2 and Table 3.4.1-3
- Extreme event** combinations as per Table 3.4.1-1, Table 3.4.1-2 and Table 3.4.1-3
- Service** combinations as per Table 3.4.1-1
- Fatigue** combinations as per Table 3.4.1-1

Other options

- Create an envelope for each combination type** Checking this option will create an envelope for each chosen combination type.
- Advanced** Provides a design code-specific editable tabular listing of the load types and the associated factors to be considered.

Add / replace combinations

- Add / Replace** When re-running the Design Combination wizard it is possible (depending upon settings made) to add new combinations to those already present in the Analyses  Treeview, or to replace (remove) all combination entries present with the currently defined ones.

Combination approach

- Basic combination** Load factors are included in the combination name for a **basic combination**.
- Smart combination** Load factors are not included in the combination name for a **smart combination** due to the variable nature of the factors.

Implementation Notes for Design Combinations to AASHTO 8th Edition

The following implementation notes refer to the requirements for bridge loading to:

- AASHTO 8th Edition** AASHTO LRFD Bridge Design Specifications, 7th Edition, American Association of State Highway and Transportation Officials, 2017.

General notes

- When considering the load factors for permanent loads due to superimposed deformations from table 3.4.1-3, currently 'Non-segmental concrete superstructures' is the only option included.
- The **Vehicle Load Optimisation** facility gives two options for creation of traffic loads: 'Patterns and global factors', and 'Patterns only'. 'Patterns only' is currently the only option that is compatible with this combination function.
- Construction stage load combinations are not currently considered (Article 3.4.2).
- Rail transit load combinations are not currently considered (Article 3.6.1.5).
- The requirements of individual State Bridge Design Manuals have not currently been allowed for.

Downdrag

When considering downdrag, Table 3.4.1-2 considers three methods of determining the effects. Different γ_p load factors apply to each of the methods. Each of the methods is given a separate entry in the load type droplist. The following modified designations apply:

- **DDal** = Downdrag: Piles, α Tomlinson Method
- **DDla** = Downdrag: Piles, λ Method
- **DDor** = Downdrag: Drilled Shafts, O'Neill & Reece (2010) Method

Earth pressure

When considering horizontal earth pressure each of the three cases in Table 3.4.1-2 (Active, At-Rest and AEP for anchored walls) is given a separate entry in the load type droplist. This is to allow for different γ_p load factors to apply to different walls within the model. The following modified designations apply:

- **EHac** = Horizontal Earth Pressure, Active
- **EHar** = Horizontal Earth Pressure, At-Rest
- **EHaep** = Horizontal Earth Pressure, AEP for anchored walls

For vertical earth pressure from Table 3.4.1-2 buried structures are not considered. The remaining three cases are given a separate entry in the load type droplist. The following modified designations apply:

- **EVos** = Vertical Earth Pressure, Overall Stability
- **EVrwa** = Vertical Earth Pressure, Retaining Walls and Abutments
- **EVrf** = Vertical Earth Pressure, Rigid Frames

Vehicle loads

The **Vehicle Load Optimisation** facility output creates separate load cases for each of the following:

- **LNN** = Notional design load
- **LLP** = Strength II (Permit) unfactored
- **LLF** = Fatigue
- Deflection

In the foregoing, the appropriate multiple presence factor, m , and the dynamic load allowance (IM) in Table 3.4.1-1 have been applied in the VLO and so are excluded from the load types.

The deflection output from VLO is not considered in combination with any other load and so is not assigned a load type.

As described in Article 3.4.1 two values are provided for the force effect due to uniform temperature (TU). The user can chose from options to create load combinations to consider:

- Deformations
- Other effects
- Both deformations and other effects

For each combination option a separate folder is created for combinations to differentiate between deformations and other effects. It should be noted that if the Uniform Temperature (TU) load type is not used the same combinations are created for the deformations case and the other effects case.

When considering centrifugal force or braking force (Articles 3.6.3 and 3.6.4) the co-existent vertical loads should be defined in the same load case and the appropriate load type assigned to the load case. The co-existent vertical effects should have the appropriate multiple presence factor, m , applied but not the load factor, γ_i , as this is applied in the design combination wizard.

By default Earthquake effects (EQ) load types are considered as mutually exclusive. When considering the seismic effects on 2 principle axes as per Article 3.10.8 the effects in the two directions should be considered in the same loadcase.

Fatigue load combinations do not consider centrifugal forces in combinations generated by the design combination wizard.

AASHTO 8th Table 3.4.1-1 requires γ_{LL} to be applied to live loads in Service III. Values can be 1.0 or 0.8 depending on how time dependent losses are calculated. The default value of γ_{LL} is taken as 1.0 as this is suitable where refined estimates of time-dependent losses as specified in Article 5.9.3.4 are used in the prestress calculations.

Design Combination Options - AASHTO LRFD 7th

Create load combinations for:

- Deformations
- Other effects
- Both deformation and other effects

Combination options

- Strength** combinations as per Table 3.4.1-1, Table 3.4.1-2 and Table 3.4.1-3
- Extreme event** combinations as per Table 3.4.1-1, Table 3.4.1-2 and Table 3.4.1-3
- Service** combinations as per Table 3.4.1-1
- Fatigue** combinations as per Table 3.4.1-1

Other options

- Create an envelope for each combination type** Checking this option will create an envelope for each chosen combination type.
- Advanced** Provides a design code-specific editable tabular listing of the load types and the associated factors to be considered.

Add / replace combinations

- Add / Replace** When re-running the Design Combination wizard it is possible (depending upon settings made) to add new combinations to those already present in the Analyses  Treeview, or to replace (remove) all combination entries present with the currently defined ones.

Combination approach

- Basic combination** Load factors are included in the combination name for a **basic combination**.
- Smart combination** Load factors are not included in the combination name for a **smart combination** due to the variable nature of the factors.

Implementation Notes for Design Combinations to AASHTO 7th Edition

The following implementation notes refer to the requirements for bridge loading to:

- **AASHTO 7th Edition** AASHTO LRFD Bridge Design Specifications, 7th Edition, American Association of State Highway and Transportation Officials, 2014.

General notes

- When considering the load factors for permanent loads due to superimposed deformations from table 3.4.1-3, currently 'Non-segmental concrete superstructures' is the only option included.
- The **Vehicle Load Optimisation** facility gives two options for creation of traffic loads: 'Patterns and global factors', and 'Patterns only'. 'Patterns only' is currently the only option implemented.
- Construction stage load combinations are not currently considered (Article 3.4.2).
- Rail transit load combinations are not currently considered (Article 3.6.1.5).
- The requirements of individual State Bridge Design Manuals have not currently been allowed for.

Downdrag

When considering downdrag, Table 3.4.1-2 considers three methods of determining the effects. Different γ_p load factors apply to each of the methods. Each of the methods is given a separate entry in the load type droplist. The following modified designations apply:

- **DDal** = Downdrag: Piles, α Tomlinson Method
- **DDla** = Downdrag: Piles, λ Method
- **DDor** = Downdrag: Drilled Shafts, O'Neill & Reece (1999) Method

Earth pressure

When considering horizontal earth pressure each of the three cases in Table 3.4.1-2 (Active, At-Rest and AEP for anchored walls) is given a separate entry in the load type droplist. This is to allow for different γ_p load factors to apply to different walls within the model. The following modified designations apply:

- **EHac** = Horizontal Earth Pressure, Active

- **EHar** = Horizontal Earth Pressure, At-Rest
- **EHaep** = Horizontal Earth Pressure, AEP for anchored walls

For vertical earth pressure from Table 3.4.1-2 buried structures are not considered. The remaining three cases are given a separate entry in the load type droplist. The following modified designations apply:

- **EVos** = Vertical Earth Pressure, Overall Stability
- **EVrwa** = Vertical Earth Pressure, Retaining Walls and Abutments
- **EVrf** = Vertical Earth Pressure, Rigid Frames

When considering vertical earth pressure in Table 3.4.1-2 the options are limited to Overall Stability, Retaining Walls & Abutments and Rigid Frames. Rigid Buried Structure and Flexible Buried Structures are not considered.

Vehicle loads

The **Vehicle Load Optimisation** facility output creates separate load cases for each of the following:

- **LNN** = Notional design load
- **LLP** = Strength II (Permit) unfactored
- **LLF** = Fatigue
- Deflection

In the foregoing, the appropriate multiple presence factor, m , and the dynamic load allowance (IM) in Table 3.4.1-1 have been applied in the VLO and so are excluded from the load types.

The deflection output from VLO is not considered in combination with any other load and so is not assigned a load type.

As described in Article 3.4.1 two values are provided for the force effect due to uniform temperature (TU). The user can chose from options to create load combinations to consider:

- Deformations
- Other effects
- Both deformations and other effects

For each combination option a separate folder is created for combinations to differentiate between deformations and other effects. It should be noted that if the Uniform Temperature (TU) load type is not used the same combinations are created for the deformations case and the other effects case.

When considering centrifugal force or braking force (Articles 3.6.3 and 3.6.4) the co-existent vertical loads should be defined in the same load case and the appropriate load type assigned to the load case. The co-existent vertical effects should have the appropriate multiple presence factor, m , applied but not the load factor, γ_i , as this is applied in the design combination wizard.

By default Earthquake effects (EQ) load types are considered as mutually exclusive. When considering the seismic effects on 2 principle axes as per Article 3.10.8 the effects in the two directions should be considered in the same loadcase.

Fatigue load combinations do not consider centrifugal forces in combinations generated by the design combination wizard.

Design Combination Options - AS/NZS 1170

Combination options

- Ultimate limit states** combinations as per Clause 4.2
 - **Stability** as per Clause 4.2.1
 - **Strength** as per Clause 4.2.2
 - **Fire** as per Clause 4.2.4
- Serviceability limit states** combinations as per Clause 4.3 and Appendix C

Other options

- Create an envelope for each combination type** Checking this option will create an envelope for each chosen combination type.
- Advanced** Provides a design code-specific editable tabular listing of the load types and the associated factors to be considered.

Add / replace combinations

- Add / Replace** When re-running the Design Combination wizard it is possible (depending upon settings made) to add new combinations to those already present in the Analyses  Treeview, or to replace (remove) all combination entries present with the currently defined ones.

Combination approach

- Basic combination** Load factors are included in the combination name for a **basic combination**.

- Smart combination** Load factors are not included in the combination name for a **smart combination** due to the variable nature of the factors.

Implementation Notes for Design Combinations to AS/NZS 1170

The requirements for load combinations used in the assessment of structures in Australia and New Zealand are implemented in accordance with the requirements of:

- AS/NZS 1170** AS/NZS 1170.0:2002 - Standards Australia/Standards New Zealand – Structural design actions – Part 0: General principles. Authority of New Zealand Structure Verification Method B1/VM1

General notes

- For the load combinations of actions for the Serviceability Limit States (SLS) the combinations suggested in table C1, Appendix C (Guidelines for serviceability limit states) are generated.
- Combinations for cyclic actions are not included.
- Combination factors for prestressing forces are not included.
- The code indicates that the factor for self-weight of stored liquid where the density is not well defined or design liquid height is not limited (clause 4.2.3 (c)) is to be taken as the factor for imposed action. At the ultimate limit state for both Stability and Strength the factor for imposed actions is the combination factor, ψ_c . The general imposed load factor of 1.5 appears to be more appropriate and this has been assigned.

Design Combination Options - BD21/01

Combination options

- ULS - Cast iron structure** combinations as per Table 3.1
- ULS - Other** combinations as per Table 3.1

Other options

- Create an envelope for each combination type** Checking this option will create an envelope for each chosen combination type.
- Advanced** Provides a design code-specific editable tabular listing of the load types and the associated factors to be considered.

Add / replace combinations

- Add / Replace** When re-running the Design Combination wizard it is possible (depending upon settings made) to add new combinations to those already present in the Analyses Treeview, or to replace (remove) all combination entries present with the currently defined ones.

Combination approach

- Basic combination** Load factors are included in the combination name for a **basic combination**.
- Smart combination** Load factors are not included in the combination name for a **smart combination** due to the variable nature of the factors.

Implementation Notes for Design Combinations to BD 21/01

The requirements for load combinations used in the assessment of highway bridges in the UK are implemented in accordance with the requirements of:

- BD21/01**, Design Manual for Roads and Bridges BD 21/01 Volume 3, Section 4, Part 3 – The Assessment of Highway Bridges and Structures May 2001, The Highways Agency, Scottish Executive Development Department, The National Assembly for Wales, The Department for Regional Development Northern Ireland

Design Combination Options - BD37/01**In Service condition**

- ULS** combinations as per Table 1
- SLS** combinations as per Table 1

Erection condition

- ULS** combinations as per Table 1
- SLS** combinations as per Table 1

Other options

- Create an envelope for each combination type** Checking this option will create an envelope for each chosen combination type.
- Advanced** Provides a design code-specific editable tabular listing of the load types and the associated factors to be considered.

Add / replace combinations

- Add / Replace** When re-running the Design Combination wizard it is possible (depending upon settings made) to add new combinations to those already present in the Analyses  Treeview, or to replace (remove) all combination entries present with the currently defined ones.

Combination approach

- Basic combination** Load factors are included in the combination name for a **basic combination**.
- Smart combination** Load factors are not included in the combination name for a **smart combination** due to the variable nature of the factors.

Implementation Notes for Design Combinations to BD 37/01

The following implementation notes refer to the requirements for bridge loading to:

- **BD 37/01**, Design Manual for Roads and Bridges BD 37/01 Volume 1, Section 3, Part 14 – Loads for Highway Bridges (including correction) May 2002, The Highways Agency, Scottish Executive Development Department, The National Assembly for Wales, The Department for Regional Development Northern Ireland

General notes

- When considering the global effects of loads due to vehicle collision with parapets (Clause 6.7.2) the load factor is dependent on the type of structure (massive or light) and the element under consideration (superstructure, wing walls, bearings etc.). Currently there is no restriction to ensure sensible and consistent combinations.
- Railway bridges are not currently included.

Vehicle loads

The alternative values of γ_L for dead and superimposed dead loads to BD 37/01 Table 1 are not considered.

The local effects from loads due to vehicle collision with parapets (Clause 6.7.1) is not considered.

The **Vehicle Load Optimisation** facility creates separate load cases for each of the following using combinations of HA loading and HB loading as appropriate:

- ULS combination 1
- ULS combination 2 and 3
- SLS combination 1
- SLS combination 2 and 3

In the combinations listed above the appropriate lane factor, β , and load factor, γ_L , have been applied in the Vehicle Load Optimisation facility. Therefore in the load combination wizard a load factor of 1.0 is assigned in all cases.

When considering secondary live loads, the associated primary live load should be defined in the same load combination as the secondary load for the following loads:

- Centrifugal load

- Longitudinal load (note two load types are available depending on whether the primary load is HA or HB)
- Accidental skidding

These load combinations are then assigned the appropriate load type.

For ULS Combination 2 it should be noted that the 'Wind: in service (Ws)' has three possible values depending on whether or not traffic load effects are included and if the effect of wind is relieving. On the Advanced option dialog the load factor for the case with traffic load is shown. The case of wind without traffic load and the relieving effect of wind with or without traffic is considered but is not shown on the dialog.

For erection stage combinations, loads due to 'Differential Settlement' are not included as it is assumed that this has not yet occurred.

Design Combination Options - CSA-S6-14

Combination options

- Fatigue limit state** combinations as per Table 3.1
- Serviceability limit states** combinations as per Table 3.1
- Ultimate limit states** combinations as per Table 3.1, Table 3.2 and Table 3.3

Other options

- Create an envelope for each combination type** Checking this option will create an envelope for each chosen combination type.
- Advanced** Provides a design code-specific editable tabular listing of the load types and the associated factors to be considered.

Add / replace combinations

- Add / Replace** When re-running the Design Combination wizard it is possible (depending upon settings made) to add new combinations to those already present in the Analyses  Treeview, or to replace (remove) all combination entries present with the currently defined ones.

Combination approach

- Basic combination** Load factors are included in the combination name for a **basic combination**.
- Smart combination** Load factors are not included in the combination name for a **smart combination** due to the variable nature of the factors.

Implementation Notes for Design Combinations to CSA S6-14

The requirements for load combinations used in the assessment of highway bridges in Canada are implemented in accordance with the requirements of:

- ❑ **CSA-S6-14**, CSA-S6-14, Canadian Highway Bridge Design Code, Dec 2014, CSA Group.

Vehicle loads

The **Vehicle Load Optimisation** facility output ('Patterns only (no global factors)') creates load cases. Modification factor for multi-lane loading table 3.6, has been applied in the Vehicle Load Optimisation facility. The load combination generator wizard only uses the Pattern loadings from the Vehicle Load Optimisation facility.

Implementation Notes for Design Combinations to EN 1990 Highways Bridges Ireland National Annex

The requirements for the Irish National annex for highway bridges are implemented in accordance with the requirements of:

- ❑ **NA to IS EN 1990:2002+A1:2005** Ireland National Annex to Eurocode – Basis of structural design, National Standards Authority of Ireland, Dublin, Dec 2005 [Ref. 1]

Reference should also be made to :

- ❑ **NA to IS EN 1991-2:2003** National Annex to Eurocode 1: Actions on structures – Part 2:Traffic loads on bridges, National Standards Authority of Ireland, Dublin, Dec 2005.

General notes

- Railway bridges are not currently implemented.
- Load combinations for footbridges are not currently implemented
- For the Ultimate limit state, and for the three sets of factors applicable, namely: Set A for static equilibrium, Set B for design of structural members not involving geotechnical actions, and Set C for design of structural members involving geotechnical actions, only Set B has been implemented to date.
- The implementation is currently limited to persistent combinations. Transient combinations (including the execution stage) are not considered.
- When considering settlement, only a load type for settlement using linear elastic analysis is permitted.

Traffic loads

The **Vehicle Load Optimisation** facility creates separate load cases for each of the following using combinations of Group 1a – LM1, Group 4 – LM4 and Group 5 – LM3 as appropriate:

- Traffic Load – characteristic

- Traffic Load – combination
- Traffic Load – frequent

When using these load types it should be noted that the ψ factors and α adjustment factors are applied in the Vehicle Load Optimisation facility. Subsequently, when using the design combination wizard, the appropriate partial factor for variable loads, γ_Q , is applied.

In order to ensure that each of the different ultimate and serviceability limit state combinations can be generated, each of the traffic load types (characteristic, combination, frequent, quasi-permanent (and possibly infrequent)) must be assigned.

Horizontal forces to clause 4.4 are not included in the Vehicle Load Optimisation. When these load types are included they are combined with the traffic load type “Traffic Load – frequent” (assuming this load type is defined). For this reason the “Traffic Load – frequent” has a γ_Q factor applied to it. Note that if the Vehicle Load Optimisation creates a “Traffic Load – frequent” based on LM4 Crowd loading this will still be combined with the horizontal force load types.

Footway and cycle track loading to clause 5.3.2 is not considered as part of the Vehicle Load Optimisation. No load type exists or it. Load combinations with Footway and cycle track loading should be created outside of the load combination wizard.

Prestress

[Ref. 1] Table NA.9 notes that recommended values for γ_P are defined in the relevant design Eurocode or for the individual project and agreed with the relevant authority. The value of both $\gamma_{P,fav}$ and $\gamma_{P,unfav}$ is taken as 0.9. These values may be modified using the Advanced options dialog if necessary.

Wind and other actions

The γ_Q for wind loads is taken as 1.70. The reduced value of $\gamma_Q = 1.55$ from NA to IS EN 1990:2002+A1:2005 [Ref. 1] Table NA.9 Note 6 is not considered.

There appears to be an error in NA to IS EN 1990:2002+A1:2005 [Ref. 1] Table NA.7. For the wind load F^*w the load component “During execution” is applied. However F^*w is defined as Wind force compatible with road traffic (Clause A2.1.2). It is thought that the “During execution” reference possibly applies to the snow load in Table NA.A2.1. This interpretation would be consistent with the base EN 1990 document Table A2.1. There appears to be an error in NA to IS EN 1990:2002+A1:2005 [Ref. 1] Table NA.7. However in the case of the Irish National annex F_w is used instead of F^*w . Note that F_w is defined as “Wind load (general symbol)”.

Snow loads

Snow loads are not considered on road bridges as per clause NA.2.3.3.3 of NA to IS EN 1990:2002+A1:2005 [Ref.1]. For special cases (as referred to in this clause) these combinations need to be created by the user.

Water

The effects of water as described in NA to IS EN 1990:2002+A1:2005 [Ref. 1] Table NA.9 Note 3 are not considered.

Settlement in combinations

For the serviceability limit state two scenarios of permanent loads are considered – those with settlement effects and those without settlement effects. This is to account for the possibility of settlement having both an adverse and beneficial effect on the structure depending upon structural configuration and the location under consideration.

Implementation Notes for Design Combinations to EN 1990 Highways Bridges Ireland National Annex

The requirements for the Irish National annex for highway bridges are implemented in accordance with the requirements of:

- ❑ **NA to IS EN 1990:2002+A1:2005** Ireland National Annex to Eurocode – Basis of structural design, National Standards Authority of Ireland, Dublin, Dec 2005 [Ref. 1]

Reference should also be made to :

- ❑ **NA to IS EN 1991-2:2003** National Annex to Eurocode 1: Actions on structures – Part 2:Traffic loads on bridges, National Standards Authority of Ireland, Dublin, Dec 2005.

General notes

- Railway bridges are not currently implemented.
- Load combinations for footbridges are not currently implemented
- For the Ultimate limit state, and for the three sets of factors applicable, namely: Set A for static equilibrium, Set B for design of structural members not involving geotechnical actions, and Set C for design of structural members involving geotechnical actions, only Set B has been implemented to date.
- The implementation is currently limited to persistent combinations. Transient combinations (including the execution stage) are not considered.
- When considering settlement, only a load type for settlement using linear elastic analysis is permitted.

Traffic loads

The **Vehicle Load Optimisation** facility creates separate load cases for each of the following using combinations of Group 1a – LM1, Group 4 – LM4 and Group 5 – LM3 as appropriate:

- Traffic Load – characteristic
- Traffic Load – combination
- Traffic Load – frequent

When using these load types it should be noted that the ψ factors and α adjustment factors are applied in the Vehicle Load Optimisation facility. Subsequently, when using the design combination wizard, the appropriate partial factor for variable loads, γ_Q , is applied.

In order to ensure that each of the different ultimate and serviceability limit state combinations can be generated, each of the traffic load types (characteristic, combination, frequent, quasi-permanent (and possibly infrequent)) must be assigned.

Horizontal forces to clause 4.4 are not included in the Vehicle Load Optimisation. When these load types are included they are combined with the traffic load type “Traffic Load – frequent” (assuming this load type is defined). For this reason the “Traffic Load – frequent” has a γ_Q factor applied to it. Note that if the Vehicle Load Optimisation creates a “Traffic Load – frequent” based on LM4 Crowd loading this will still be combined with the horizontal force load types.

Footway and cycle track loading to clause 5.3.2 is not considered as part of the Vehicle Load Optimisation. No load type exists or it. Load combinations with Footway and cycle track loading should be created outside of the load combination wizard.

Prestress

[Ref. 1] Table NA.9 notes that recommended values for γ_P are defined in the relevant design Eurocode or for the individual project and agreed with the relevant authority. The value of both $\gamma_{P,fav}$ and $\gamma_{P,unfav}$ is taken as 0.9. These values may be modified using the Advanced options dialog if necessary.

Wind and other actions

The γ_Q for wind loads is taken as 1.70. The reduced value of $\gamma_Q = 1.55$ from NA to IS EN 1990:2002+A1:2005 [Ref. 1] Table NA.9 Note 6 is not considered.

There appears to be an error in NA to IS EN 1990:2002+A1:2005 [Ref. 1] Table NA.7. For the wind load F^*w the load component “During execution” is applied. However F^*w is defined as Wind force compatible with road traffic (Clause A2.1.2). It is thought that the “During execution” reference possibly applies to the snow load in

Table NA.A2.1. This interpretation would be consistent with the base EN 1990 document Table A2.1. There appears to be an error in NA to IS EN 1990:2002+A1:2005 [Ref. 1] Table NA.7. However in the case of the Irish National annex Fw is used instead of F*w. Note that Fw is defined as “Wind load (general symbol)”.

Snow loads

Snow loads are not considered on road bridges as per clause NA.2.3.3.3 of NA to IS EN 1990:2002+A1:2005 [Ref.1]. For special cases (as referred to in this clause) these combinations need to be created by the user.

Water

The effects of water as described in NA to IS EN 1990:2002+A1:2005 [Ref. 1] Table NA.9 Note 3 are not considered.

Settlement in combinations

For the serviceability limit state two scenarios of permanent loads are considered – those with settlement effects and those without settlement effects. This is to account for the possibility of settlement having both an adverse and beneficial effect on the structure depending upon structural configuration and the location under consideration.

Design Combination Options - EN1990 - 2002 Bridges (Recommended Values)

ULS

- Persistent combination** as per Clause 6.4.3.2
 - **Exp. 6.10** - a conservative combination (default)
 - **Exp. 6.10a and 6.10b** - alternative calculation
- Accidental combination** as per Clause 6.4.3.3
- Seismic combination** as per Clause 6.4.3.4

SLS

- Characteristic combination** as per Clause 6.5.3
- Frequent combination** as per Clause 6.5.3
- Infrequent combination** as per Clause A2.2.2
- Quasi-permanent combination** as per Clause 6.5.3

Other options

- Create an envelope for each combination type** Checking this option will create an envelope for each chosen combination type.

- Advanced** Provides a design code-specific editable tabular listing of the load types and the associated factors to be considered.

Add / replace combinations

- Add / Replace** When re-running the Design Combination wizard it is possible (depending upon settings made) to add new combinations to those already present in the Analyses Treeview, or to replace (remove) all combination entries present with the currently defined ones.

Combination approach

- Basic combination** Load factors are included in the combination name for a **basic combination**.
- Smart combination** Load factors are not included in the combination name for a **smart combination** due to the variable nature of the factors.

Implementation Notes for Design Combinations to EN 1990 Highways Bridges (Recommended Values)

The recommended values for highway bridges are implemented in accordance with the requirements of:

- BS EN 1990: 2002+A1:2005** Eurocode – Basis of structural design, British Standards Institution, Chiswick, June 2009 [Ref. 1]

Reference should also be made to:

- BS EN 1991-2: 2003** Eurocode 1: Actions on structures – Part 2: Traffic loads on bridges, British Standards Institution, Chiswick, Dec 2004 [Ref. 3]

General notes

- Railway bridges are not currently implemented.
- Load combinations for footbridges are not currently implemented
- For the Ultimate limit state, and for the three sets of factors applicable, namely: Set A for static equilibrium, Set B for design of structural members not involving geotechnical actions, and Set C for design of structural members involving geotechnical actions, only Set B has been implemented to date.
- The implementation is currently limited to persistent combinations. Transient combinations (including the execution stage) are not considered.
- When considering settlement, only a load type for settlement using linear elastic analysis is permitted.

Traffic loads

The **Vehicle Load Optimisation** facility creates separate load cases for each of the following using combinations of Group 1a – LM1, Group 4 – LM4 and Group 5 – LM3 as appropriate:

- Traffic Load – characteristic
- Traffic Load – combination
- Traffic Load – frequent
- Traffic Load – infrequent

When using these load types it should be noted that the ψ factors and α adjustment factors are applied in the Vehicle Load Optimisation facility. Subsequently, when using the load combination wizard, the appropriate partial factor for variable loads, γ_Q , is applied.

In order to ensure that each of the different ultimate and serviceability limit state combinations can be generated, each of the traffic load types (characteristic, combination, frequent, quasi-permanent (and possibly infrequent)) must be assigned.

Horizontal forces to clause 4.4 are not included in the Vehicle Load Optimisation. When these load types are included they are combined with the traffic load type “Traffic Load – frequent” (assuming this load type is defined). For this reason the “Traffic Load – frequent” has a γ_Q factor applied to it. Note that if the Vehicle Load Optimisation creates a “Traffic Load – frequent” based on LM4 Crowd loading this will still be combined with the horizontal force load types.

Footway and cycle track loading to clause 5.3.2 is not considered as part of the Vehicle Load Optimisation. Load combinations with Footway and cycle track loading should be created outside of the load combination wizard.

Prestress

EN 1990 Table A2.4(B) notes that recommended values for γ_P are defined in the relevant design Eurocode. The value of both $\gamma_{P,fav}$ and $\gamma_{P,unfav}$ is taken as 1.0. These values may be modified using the Advanced options dialog if necessary.

Wind, thermal and other actions

Wind and thermal actions are considered separately as per EN 1990 A2.2.2 (6). If local conditions or the individual project requires that they be considered simultaneously then this combination(s) must be created by manually.

For the load type 'Other variable actions (Qov)' a load factor $\gamma_Q = 1.50$ is applied based on Table A2.4B. However no ψ values are given in Table A2.1. in the absence of these

values those used for Thermal actions are adopted on the basis that they are reasonably conservative and that non-zero values exist for each of ψ_1 , ψ_2 and ψ_3 .

Cl. A2.2.2 (5) notes that: "No wind action greater than the smaller of F_w^* and $\psi_0 F_{wk}$ should be combined with Load Model 1 or with the associated group of loads gr1a.

This requirement is not fully implemented in the current implementation as the governing group of loads are not identifiable from the Vehicle Load Optimisation output. Currently it is assumed that the loadcase from the Vehicle Load Optimisation is for a group of loads gr1a and that this will always be included with the load type 'Wind compatible with Road Traffic (Qwt)'. The user must check which of F_w^* or $\psi_0 F_{wk}$ is smaller and assign this value to 'Wind compatible with Road Traffic (Qwt)' – note the inclusion of the ψ_0 parameter in the latter case. The characteristic value of the wind F_{wk} is assigned to the 'Wind Persistent (Qwp)' load type and is this is used in combinations without the loadcase from the Vehicle Load Optimisation

Snow load

The snow load, $Q_{sn,k}$, in Table A2.1 is considered for the execution stage. Snow load is not considered for the Persistent stage since Clause 1.1 (8) of BS EN 1991-1-3:2003 [Ref. 11] notes that snow loads on bridges is considered a specialist aspect and guidance is not provided in that document. Additionally as per cl. A2.2.2 (3) & (4) of BS EN 1990: 2002+A1:2005 [Ref. 1] snow loads need not be considered with traffic loads unless specified for a particular geographical area. Any such situations will be considered in the appropriate National annex.

Settlement in combinations

For the serviceability limit state two scenarios of permanent loads are considered – those with settlement effects and those without settlement effects. This is to account for the possibility of settlement having both an adverse and beneficial effect on the structure depending upon structural configuration and the location under consideration.

References to specific Eurocode design codes

[Ref. 1] BS EN 1990: 2002+A1:2005 Eurocode – Basis of structural design, British Standards Institution, Chiswick, June 2009

[Ref. 3] BS EN 1991-2: 2003 Eurocode 1: Actions on structures – Part 2: Traffic loads on bridges, British Standards Institution, Chiswick, Dec 2004

[Ref. 11] BS EN 1991-1-3:2003 Eurocode 1: Actions on structures – Part 1-3: General Actions – Snow loads, British Standards Institution, Chiswick, Month, Year

Design Combination Options - EN1990 - 2002 Bridges (UK National Annex)

The combination options shown below relate to the following design code:

- EN1990 - 2002 (Bridges) to UK National Annex

ULS

- Persistent combination** as per Clause 6.4.3.2
- Accidental combination** as per Clause 6.4.3.3
- Seismic combination** as per Clause 6.4.3.4

SLS

- Characteristic combination** as per Clause 6.5.3
- Frequent combination** as per Clause 6.5.3
- Quasi-permanent combination** as per Clause 6.5.3

Other options

- Create an envelope for each combination type** Checking this option will create an envelope for each chosen combination type.
- Advanced** Provides a design code-specific editable tabular listing of the load types and the associated factors to be considered.

Add / replace combinations

- Add / Replace** When re-running the Design Combination wizard it is possible (depending upon settings made) to add new combinations to those already present in the Analyses Treeview, or to replace (remove) all combination entries present with the currently defined ones.

Combination approach

- Basic combination** Load factors are included in the combination name for a **basic combination**.
- Smart combination** Load factors are not included in the combination name for a **smart combination** due to the variable nature of the factors.

Implementation Notes for Design Combinations to EN 1990 Highways Bridges UK National Annex

The requirements for the UK National annex for highway bridges are implemented in accordance with the requirements of:

- NA to BS EN 1990:2002+A1:2005** UK National Annex for Eurocode – Basis of structural design (including National Amendment No. 1), British Standards Institution, Chiswick, Jun 2009 [Ref. 2]

Reference should also be made to:

- NA to BS EN 1991-2:2003** UK National Annex to Eurocode 1: Actions on structures – Part 2:Traffic loads on bridges (including Corrigendum No 1), British Standards Institution, Chiswick, May 2008.

General notes

- Railway bridges are not currently implemented.
- Load combinations for footbridges are not currently implemented
- For the Ultimate limit state, and for the three sets of factors applicable, namely: Set A for static equilibrium, Set B for design of structural members not involving geotechnical actions, and Set C for design of structural members involving geotechnical actions, only Set B has been implemented to date.
- The implementation is currently limited to persistent combinations. Transient combinations (including the execution stage) are not considered.
- When considering settlement, only a load type for settlement using linear elastic analysis is permitted.

Traffic loads

The **Vehicle Load Optimisation** facility creates separate load cases for each of the following using combinations of Group 1a – LM1, Group 4 – LM4 and Group 5 – LM3 as appropriate:

- Traffic Load – characteristic
- Traffic Load – combination
- Traffic Load – frequent

When using these load types it should be noted that the ψ factors and α adjustment factors are applied in the Vehicle Load Optimisation facility. Subsequently, when using the load combination wizard, the appropriate partial factor for variable loads, γ_Q , is applied.

In order to ensure that each of the different ultimate and serviceability limit state combinations can be generated, each of the traffic load types (characteristic, combination, frequent, quasi-permanent (and possibly infrequent)) must be assigned.

Horizontal forces to clause 4.4 are not included in the Vehicle Load Optimisation. When these load types are included they are combined with the traffic load type “Traffic Load – frequent” (assuming this load type is defined). For this reason the “Traffic Load – frequent” has a γ_Q factor applied to it. Note that if the Vehicle Load Optimisation creates a “Traffic Load – frequent” based on LM4 Crowd loading this will still be combined with the horizontal force load types.

Footway and cycle track loading to clause 5.3.2 is not considered as part of the Vehicle Load Optimisation. No load type exists or it. Load combinations with

Footway and cycle track loading should be created outside of the load combination wizard.

Prestress

NA to BS EN 1990:2002+A1:2005 [Ref. 2] Table NA.A2.4(B) notes that recommended values for γ_P are defined in the relevant design Eurocode or for the individual project. The value of both $\gamma_{P,fav}$ and $\gamma_{P,unfav}$ is taken as 0.9. These values may be modified using the Advanced options dialog if necessary.

Wind actions

The γ_Q for wind loads is taken as 1.70. The reduced value of $\gamma_Q = 1.55$ from NA to BS EN 1990:2002+A1:2005 [Ref. 2] Table NA.A2.4(B) Note 5 is not considered.

There appears to be an error in NA to BS EN 1990:2002+A1:2005 [Ref. 2] Table NA.A2.1. For the wind load F^*w the load component “During execution” is applied. However F^*w is defined as Wind force compatible with road traffic (Clause A2.1.2). It is thought that the “During execution” reference possibly applies to the snow load in Table NA.A2.1. This interpretation would be consistent with the base EN 1990 document Table A2.1.

Snow loads

Snow loads are not considered on road bridges as per NA to BS EN 1990:2002+A1:2005 [Ref. 2] clause NA.2.3.3.3. For special cases (as referred to in this clause) these combinations need to be created by the user.

Water

The effects of water as described in NA to BS EN 1990:2002+A1:2005 [Ref. 2] Table NA.A2.4(B) Note 2 are not considered.

Settlement in combinations

For the serviceability limit state two scenarios of permanent loads are considered – those with settlement effects and those without settlement effects. This is to account for the possibility of settlement having both an adverse and beneficial effect on the structure depending upon structural configuration and the location under consideration.

Design Combination Options - EN1990 - 2002 Buildings (Finland)

The combination options shown below relate to the following design codes:

- EN1990 - 2002 (Buildings) to Finland National Annex**

Clauses referenced relate to the base document.

Reliability class

A single reliability class can be selected each time the Design Combination wizard is run. If different reliability classes are required for different parts of the structure the Design wizard should be run again and the appropriate loadtypes included and the option to 'Add' combinations selected. If the 'Create an envelope for each combination type' is checked for both the initial and subsequent run, all combinations will be included in a single envelopes. Mixing of different reliability class factors within a single combination are outside the scope of the combination wizard. The default reliability class is RC2.

ULS

- Fundamental combination** (Cl. 6.4.3.2)
- Accidental combination** (Cl. 6.4.3.3)
- Seismic combination** (Cl. 6.4.3.4)

SLS

- Characteristic combination** (Cl. 6.5.3)
- Frequent combination** (Cl. 6.5.3)
- Quasi-permanent combination** (Cl. 6.5.3)

Other options

- Create an envelope for each combination type** Checking this option will create an envelope for each chosen combination type.
- Advanced** Provides a design code-specific editable tabular listing of the load types and the associated factors to be considered.

Add / replace combinations

- Add / Replace** When re-running the Design Combination wizard it is possible (depending upon settings made) to add new combinations to those already present in the Analyses  Treeview, or to replace (remove) all combination entries present with the currently defined ones.

Combination approach

- Basic combination** Load factors are included in the combination name for a **basic combination**.
- Smart combination** Load factors are not included in the combination name for a **smart combination** due to the variable nature of the factors.

Implementation Notes for Design Combinations to EN 1990 Buildings Finland National Annex

The requirements for the Finnish National annex for buildings are implemented in accordance with the requirements of:

- ❑ **NA to SFS EN 1990** National Annex to Standard SFS-EN 1990 Eurocode: Basis of structural design, Ministry of the Environment, Helsinki, Dec 2016. [Ref. 1]

Reference should also be made to:

- ❑ **NA to SFS EN 1991-1-1:2002** National Annex to Standard SFS-EN 1991-1-1 Eurocode 1: Actions on structures – Part 1-1: General actions. Densities, self weight, imposed loads for buildings, Ministry of the Environment, Helsinki, Dec 2016.

As per Note 2 values of γ are used for imposed deformations as per [Ref 1] Table 3, and this is not considered further.

General notes

- For the Ultimate limit state, and for the three sets of factors applicable, namely: Set A for static equilibrium, Set B for design of structural members not involving geotechnical actions, and Set C for design of structural members involving geotechnical actions, only Set B has been implemented to date.
- Pattern loading is not taken into account.
- Prestressing actions are not covered by the National Annex so are not included in any of the combinations generated using the Design Combination wizard. Combinations involving prestressing actions must be created by the user.
- EN 1991-1-1 Cl. 3.3.2 (2) notes that: "When the imposed load is considered as an accompanying action, in accordance with EN 1990, only one of the two factors ψ (EN 1990, Table A1.1) and α_n (6.3.1.2 (11)) shall be applied." Since the reduction factor, α_n is not considered as part of the load combination wizard, accompanying actions will always be factored by ψ . If the α_n factor is applied to loads manually a further reduction by ψ will also be applied, which would be non-compliant with this clause.

Snow load

Exceptional snow loads on the ground are not defined in the National Annex to SFS EN 1991-1-3 [M3]). From table 1:

- Snow Load – Type 1 corresponds to Snow loads on buildings when $s_k < 2.75 \text{ kN/m}^2$
- Snow Load – Type 2 corresponds to Snow loads on buildings when $s_k \geq 2.75 \text{ kN/m}^2$

Design Combination Options - EN1990 - 2002 Buildings (Ireland)

The combination options shown below relate to the following design codes:

- EN1990 - 2002 (Buildings) to Ireland National Annex**

Clauses referenced relate to the base document.

ULS

- Fundamental combination** (Cl. 6.4.3.2)
 - **Exp. 6.10** - a conservative combination (default)
 - **Exp. 6.10a and 6.10b** - alternative calculation

- Accidental combination** (Cl. 6.4.3.3)
- Seismic combination** (Cl. 6.4.3.4)

SLS

- Characteristic combination** (Cl. 6.5.3)
- Frequent combination** (Cl. 6.5.3)
- Quasi-permanent combination** (Cl. 6.5.3)

Other options

- Create an envelope for each combination type** Checking this option will create an envelope for each chosen combination type.
- Advanced** Provides a design code-specific editable tabular listing of the load types and the associated factors to be considered.

Add / replace combinations

- Add / Replace** When re-running the Design Combination wizard it is possible (depending upon settings made) to add new combinations to those already present in the Analyses Treeview, or to replace (remove) all combination entries present with the currently defined ones.

Combination approach

- Basic combination** Load factors are included in the combination name for a **basic combination**.
- Smart combination** Load factors are not included in the combination name for a **smart combination** due to the variable nature of the factors.

Implementation Notes for Design Combinations to EN 1990 Buildings Irish National Annex

The requirements for the Irish National annex for buildings are implemented in accordance with the requirements of:

- ❑ **NA to IS EN 1990:2002+A1:2005** Irish National Annex to Eurocode – Basis of structural design, National Standards Authority of Ireland, Dublin, Dec 2005 [Ref. 1].

Reference should also be made to:

- ❑ **NA to IS EN 1991-1-1:2002** Irish National Annex to Eurocode 1: Actions on structures – Part 1-1: General Actions – Densities, self-weight, imposed loads for buildings, National Standards Authority of Ireland, Dublin, Dec 2005 [Ref. 2].

Values of γ to be used for imposed deformations as per NA to IS EN 1990:2002+A1:2005 [Ref. 1] Table NA.4 Note 2 is not considered further.

General notes

- For the Ultimate limit state, and for the three sets of factors applicable, namely: Set A for static equilibrium, Set B for design of structural members not involving geotechnical actions, and Set C for design of structural members involving geotechnical actions, only Set B has been implemented to date.
- Pattern loading is not taken into account.
- Prestressing actions are not covered by the National Annex so are not included in any of the combinations generated using the Design Combination wizard. Combinations involving prestressing actions must be created by the user.
- EN 1991-1-1 Cl. 3.3.2 (2) notes that: "When the imposed load is considered as an accompanying action, in accordance with EN 1990, only one of the two factors ψ (EN 1990, Table A1.1) and α_n (6.3.1.2 (11)) shall be applied." Since the reduction factor, α_n is not considered as part of the load combination wizard, accompanying actions will always be factored by ψ . If the α_n factor is applied to loads manually a further reduction by ψ will also be applied.

Snow load

In relation to clause 4.1.1 (2) snow loads are taken as variable actions. Where a snow load is to be considered an accidental action (as determined per the requirements of NA to IS EN 1991-1-3:2002 [Ref. 3]) it should be assigned the accidental loadtype.

Load combinations

When considering accidental combinations NA to IS EN 1990:2002+A1:2005 [Ref. 1] Table NA.6 refers to BS EN 1991-1-2:2002 (actions on structures exposed to fire), for which clause 4.3.1 (2) allows the use of the frequent or quasi-permanent value of the action. The frequent value has been conservatively used.

References

[Ref. 1] NA to IS EN 1990:2002+A1:2005 – Irish National Annex to Eurocode – Basis of structural design, National Standards Authority of Ireland, Dublin, Dec 2005

[Ref. 2] NA to IS EN 1991-1-1:2002 – Irish National Annex to Eurocode 1: Actions on structures – Part 1-1: General Actions – Densities, self-weight, imposed loads for buildings, National Standards Authority of Ireland, Dublin, Dec 2005

[Ref. 3] NA to IS EN 1991-1-3:2002– Irish National Annex to Eurocode 1: Actions on structures – Part 1-3: General Actions – Snow loads (including Corrigendum No 1), National Standards Authority of Ireland, Dublin, Dec 2005

Design Combination Options - EN1990 - 2002 Buildings (Italy)

The combination options shown below relate to the following design codes:

- EN1990 - 2002 (Buildings) to Italy National Annex**

Clauses referenced relate to the base document.

ULS

- Fundamental combination** (Cl. 6.4.3.2)
- Accidental combination** (Cl. 6.4.3.3)
- Seismic combination** (Cl. 6.4.3.4)

SLS

- Characteristic combination** (Cl. 6.5.3)
- Frequent combination** (Cl. 6.5.3)
- Quasi-permanent combination** (Cl. 6.5.3)

Other options

- Create an envelope for each combination type** Checking this option will create an envelope for each chosen combination type.
- Advanced** Provides a design code-specific editable tabular listing of the load types and the associated factors to be considered.

Add / replace combinations

- ❑ **Add / Replace** When re-running the Design Combination wizard it is possible (depending upon settings made) to add new combinations to those already present in the Analyses Treeview, or to replace (remove) all combination entries present with the currently defined ones.

Combination approach

- ❑ **Basic combination** Load factors are included in the combination name for a **basic combination**.
- ❑ **Smart combination** Load factors are not included in the combination name for a **smart combination** due to the variable nature of the factors.

Implementation Notes for Design Combinations to EN 1990 Buildings Italy National Annex

The requirements for the Italian National annex for buildings are implemented in accordance with the requirements of:

- ❑ **NA to UNI-EN 1990** Appendice nazionale: UNI-EN-1990 –Criteri generali di progettazione strutturale, Ente Nazionale Italiano di Unificazione, Milan, July 2007. [Ref. 1]

Reference should also be made to:

- ❑ **NA to UNI-EN 1991-1-1** Appendice nazionale: UNI-EN-1991-1-1 – Azioni sulle strutture - Parte 1-1: Azioni generali – Densità, pesi propri, sovraccarichi per edifici, Ente Nazionale Italiano di Unificazione, Milan, July 2007

General notes

- For the Ultimate limit state, and for the three sets of factors applicable, namely: Set A for static equilibrium, Set B for design of structural members not involving geotechnical actions, and Set C for design of structural members involving geotechnical actions, only Set B has been implemented to date.
- Pattern loading is not taken into account.
- Prestressing actions are not covered by the National Annex, so are not included in any of the combinations generated using the Design Combination wizard. Combinations involving prestressing actions must be created by the user.
- EN 1991-1-1 Cl. 3.3.2 (2) notes that: "When the imposed load is considered as an accompanying action, in accordance with EN 1990, only one of the two factors ψ (EN 1990, Table A1.1) and α_n (6.3.1.2 (11)) shall be applied." Since the reduction factor, α_n is not considered as part of the load combination wizard, accompanying actions will always be factored by ψ . If the α_n factor is applied to loads manually a further reduction by ψ will also be applied, which would be non-compliant with this clause.

Snow load

Exceptional snow loads do not apply in Italy as determined per the requirements of NA to UNI-EN 1991-1-3 [E3].

Design Combination Options - EN1990 - 2002 Buildings (Norway)

The combination options shown below relate to the following design codes:

- EN1990 - 2002 (Buildings) to Norway National Annex**

Clauses referenced relate to the base document.

ULS

- Fundamental combination** (Cl. 6.4.3.2)
- Accidental combination** (Cl. 6.4.3.3)
- Seismic combination** (Cl. 6.4.3.4)

SLS

- Characteristic combination** (Cl. 6.5.3)
- Frequent combination** (Cl. 6.5.3)
- Quasi-permanent combination** (Cl. 6.5.3)

Other options

- Create an envelope for each combination type** Checking this option will create an envelope for each chosen combination type.
- Advanced** Provides a design code-specific editable tabular listing of the load types and the associated factors to be considered.

Add / replace combinations

- Add / Replace** When re-running the Design Combination wizard it is possible (depending upon settings made) to add new combinations to those already present in the Analyses  Treeview, or to replace (remove) all combination entries present with the currently defined ones.

Combination approach

- Basic combination** Load factors are included in the combination name for a **basic combination**.
- Smart combination** Load factors are not included in the combination name for a **smart combination** due to the variable nature of the factors.

Implementation Notes for Design Combinations to EN 1990 Buildings Norway National Annex

The requirements for the Norway National annex for buildings are implemented in accordance with the requirements of:

- ❑ **NA to NS-EN 1990** NS-EN 1990:2002+A1:2005+NA:2016 – Eurocode: Basis of structural design, Standards Norway, Oslo, 2016 [Ref. 1]

Reference should also be made to:

- ❑ **NS-EN 1991-1-1** NS-EN 1991-1-1:2002+NA:2008 – Eurocode 1: Actions on structures Part 1-1: General Actions – Densities, self-weight, imposed loads for buildings Standards Norway, Oslo, 2008. [Ref. 2]
- ❑ **BS EN 1991-1-2:2002 Eurocode 1:** Actions on structures – Part 1-2: General actions – Actions on structures exposed to fire, British Standards Institution, Chiswick [Ref. 3]

General notes

- For the Ultimate limit state, and for the three sets of factors applicable, namely: Set A for static equilibrium, Set B for design of structural members not involving geotechnical actions, and Set C for design of structural members involving geotechnical actions, only Set B has been implemented to date.
- Pattern loading is not taken into account.
- Prestressing actions are not covered by the National Annex so are not included in any of the combinations generated using the Design Combination wizard.
- EN 1991-1-1 Cl. 3.3.2 (2) notes that: "When the imposed load is considered as an accompanying action, in accordance with EN 1990, only one of the two factors ψ (EN 1990, Table A1.1) and α_n (6.3.1.2 (11)) shall be applied." Since the reduction factor, α_n is not considered as part of the load combination wizard, accompanying actions will always be factored by ψ . If the α_n factor is applied to loads manually a further reduction by ψ will also be applied.
- The option of applying reduction factor, k_{Fi} , to structures in reliability class 1, as per clause NA.A1.3.1(1), has not been implemented due to the limited nature of its use.
- When considering accidental combinations [Ref. 1] Table NA.A1.3 refers to EN 1991-1-2 [Ref. 3] (actions on structures exposed to fire). [Ref. 3] clause 4.3.1 (2) allows the use of the frequent or quasi-permanent value of the action. The note to this clause recommends the use of the quasi-permanent value but the choice is to be determined from the National annex. As implemented the frequent value has been conservatively used.

- The intent of [Ref. 1] Note 1 to Table NA. A1.3 is unclear, so the implementation has been made on the basis of it applying to all accidental actions, which would be non-compliant with this clause.

Design Combination Options - EN1990 - 2002 Buildings (Recommended Values)

The combination options shown below relate to the following design codes:

EN1990 - 2002 (Buildings) Recommended Values

Clauses referenced relate to the base document.

ULS

- Fundamental combination** (Cl. 6.4.3.2)
 - **Exp. 6.10** - a conservative combination (default)
 - **Exp. 6.10a and 6.10b** - alternative calculation

Accidental combination (Cl. 6.4.3.3)

Seismic combination (Cl. 6.4.3.4)

SLS

Characteristic combination (Cl. 6.5.3)

Frequent combination (Cl. 6.5.3)

Quasi-permanent combination (Cl. 6.5.3)

Other options

- Create an envelope for each combination type** Checking this option will create an envelope for each chosen combination type.
- Advanced** Provides a design code-specific editable tabular listing of the load types and the associated factors to be considered.

Add / replace combinations

- Add / Replace** When re-running the Design Combination wizard it is possible (depending upon settings made) to add new combinations to those already present in the Analyses  Treeview, or to replace (remove) all combination entries present with the currently defined ones.

Combination approach

- Basic combination** Load factors are included in the combination name for a **basic combination**.
- Smart combination** Load factors are not included in the combination name for a **smart combination** due to the variable nature of the factors.

"Implementation Notes for Design Combinations to EN 1990 Buildings Recommended Values" on page 294

Implementation Notes for Design Combinations to EN 1990 Buildings Recommended Values

The recommended values for buildings are implemented in accordance with the requirements of:

- ❑ **BS EN 1990: 2002+A1:2005** Eurocode – Basis of structural design, British Standards Institution, Chiswick, June 2009 [Ref. 1]

Reference should also be made to:

- ❑ **BS EN 1991-1-1:2002** Eurocode 1: Actions on structures – Part 1-1: General Actions – Densities, self-weight, imposed loads for buildings, British Standards Institution, Chiswick, Feb 2010.

General notes

- For the Ultimate limit state, and for the three sets of factors applicable, namely: Set A for static equilibrium, Set B for design of structural members not involving geotechnical actions, and Set C for design of structural members involving geotechnical actions, only Set B has been implemented to date.
- Pattern loading is not taken into account.
- Prestressing actions are not included in any of the combinations generated using the wizard. Combinations involving prestressing actions must be created by the user.
- EN 1991-1-1 Cl. 3.3.2 (2) notes that: "When the imposed load is considered as an accompanying action, in accordance with EN 1990, only one of the two factors ψ (EN 1990, Table A1.1) and α_n (6.3.1.2 (11)) shall be applied." Since the reduction factor, α_n is not considered as part of the load combination wizard, accompanying actions will always be factored by ψ . If the α_n factor is applied to loads manually a further reduction by ψ will also be applied.
- BS EN 1990: 2002+A1:2005 clause 6.3.1.2(10) permits the use of a reduction factor for imposed load categories A-D based on the loaded area. This reduction factor is member specific and therefore cannot be included in the combinations. It may however be manually accounted for by using the '**Distributed to perimeter**' load and the area reduction factor which can be defined as an expression in terms of 'A' the area supported by each edge of the surface to which the attribute is assigned.
- BS EN 1990: 2002+A1:2005 clause 6.3.1.2(11) permits the use of a reduction factor for imposed load categories A-D where multiple storeys are loaded. The reduction factor is only applicable to columns and walls and accounts for the

fact that not all storeys will be loaded to the maximum values simultaneously. This factor is not accommodated in the design combinations meaning that and a separate set of combinations for column design will need to be created manually applying the adjustment factor as required.

Snow load

In relation to BS EN 1990: 2002+A1:2005 clause 4.1.1 (2) snow loads are taken as variable actions. Where a snow load is to be considered an accidental action it should be assigned the accidental loadtype.

Design Combination Options - EN1990 - 2002 Buildings (Sweden)

The combination options shown below relate to the following design codes:

EN1990 - 2002 (Buildings) to Sweden National Annex

Clauses referenced relate to the base document.

Safety class

A single safety class can be selected each time the Design Combination wizard is run. If different safety classes are required for different parts of the structure the Design wizard should be run again and the appropriate loadtypes included and the option to 'Add' combinations selected. If 'Create an envelope for each combination type' is checked for both the initial and subsequent run, all combinations will be included in a single envelopes. Mixing of different safety class factors within a single combination are outside the scope of the combination wizard. The default safety class is 2.

ULS

- Fundamental combination** (Cl. 6.4.3.2)
- Accidental combination** (Cl. 6.4.3.3)
- Seismic combination** (Cl. 6.4.3.4)

SLS

- Characteristic combination** (Cl. 6.5.3)
- Frequent combination** (Cl. 6.5.3)
- Quasi-permanent combination** (Cl. 6.5.3)

Other options

- Create an envelope for each combination type** Checking this option will create an envelope for each chosen combination type.
- Advanced** Provides a design code-specific editable tabular listing of the load types and the associated factors to be considered.

Add / replace combinations

- Add / Replace** When re-running the Design Combination wizard it is possible (depending upon settings made) to add new combinations to those already present in the Analyses Treeview, or to replace (remove) all combination entries present with the currently defined ones.

Combination approach

- Basic combination** Load factors are included in the combination name for a **basic combination**.
- Smart combination** Load factors are not included in the combination name for a **smart combination** due to the variable nature of the factors.

Implementation Notes for Design Combinations to EN 1990 Buildings Sweden National Annex

The requirements for the Swedish National annex for buildings are implemented in accordance with the requirements of:

- NA to SS EN 1990** BFS 2013:10 EKS 9 Boverket mandatory provisions amending the board's mandatory provisions and general recommendations (2011:10) on the application of European design standards (Eurocodes) EKS Boverket, Karlskrona. [Ref. 1]

Reference should also be made to:

- NA to SS EN 1991-1-1** BFS 2013:10 EKS 9 Boverket mandatory provisions amending the board's mandatory provisions and general recommendations (2011:10) on the application of European design standards (Eurocodes) EKS Boverket, Karlskrona.

General notes

- For the Ultimate limit state, and for the three sets of factors applicable, namely: Set A for static equilibrium, Set B for design of structural members not involving geotechnical actions, and Set C for design of structural members involving geotechnical actions, only Set B has been implemented to date.
- Pattern loading is not taken into account.
- EN 1991-1-1 Cl. 3.3.2 (2) notes that: "When the imposed load is considered as an accompanying action, in accordance with EN 1990, only one of the two factors ψ (EN 1990, Table A1.1) and α_n (6.3.1.2 (11)) shall be applied." Since the reduction factor, α_n is not considered as part of the load combination wizard, accompanying actions will always be factored by ψ . If the α_n factor is applied to loads manually a further reduction by ψ will also be applied, which would be non-compliant with this clause.

Snow load

Exceptional snow loads are not relevant for Swedish conditions as per the requirements of the National Annex to SS EN 1991-1-3:2003

- Snow Load – Type 1 corresponds to Snow load with designations pursuant to EN 1991-1-3: $s_k \geq 3 \text{ kN/m}^2$
- Snow Load – Type 2 corresponds to Snow load with designations pursuant to EN 1991-1-3: $2.0 \leq s_k < 3.0 \text{ kN/m}^2$
- Snow Load – Type 3 corresponds to Snow load with designations pursuant to EN 1991-1-3: $1.0 \leq s_k < 2.0 \text{ kN/m}^2$

Design Combination Options - EN1990 - 2002 Buildings (UK)

The combination options shown below relate to the following design codes:

- EN1990 - 2002 (Buildings) to UK National Annex**

Clauses referenced relate to the base document.

ULS

- Fundamental combination** (Cl. 6.4.3.2)
 - **Exp. 6.10** - a conservative combination (default)
 - **Exp. 6.10a and 6.10b** - alternative calculation

- Accidental combination** (Cl. 6.4.3.3)
- Seismic combination** (Cl. 6.4.3.4)

SLS

- Characteristic combination** (Cl. 6.5.3)
- Frequent combination** (Cl. 6.5.3)
- Quasi-permanent combination** (Cl. 6.5.3)

Other options

- Create an envelope for each combination type** Checking this option will create an envelope for each chosen combination type.
- Advanced** Provides a design code-specific editable tabular listing of the load types and the associated factors to be considered.

Add / replace combinations

- Add / Replace** When re-running the Design Combination wizard it is possible (depending upon settings made) to add new combinations to those already

present in the Analyses Treeview, or to replace (remove) all combination entries present with the currently defined ones.

Combination approach

- Basic combination** Load factors are included in the combination name for a **basic combination**.
- Smart combination** Load factors are not included in the combination name for a **smart combination** due to the variable nature of the factors.

Implementation Notes for Design Combinations to EN 1990 Buildings UK National Annex

The requirements for the UK National annex for buildings are implemented in accordance with the requirements of:

- NA to BS EN 1990:2002+A1:2005** UK National Annex for Eurocode – Basis of structural design (including National Amendment No. 1), British Standards Institution, Chiswick, Jun 2009 [Ref. 2].

Reference should also be made to:

- NA to BS EN 1991-1-1:2002** UK National Annex to Eurocode 1: Actions on structures – Part 1-1: General Actions – Densities, self-weight, imposed loads for buildings, British Standards Institution, Chiswick, Dec 2005 [Ref. 5].

General notes

- For the Ultimate limit state, and for the three sets of factors applicable, namely: Set A for static equilibrium, Set B for design of structural members not involving geotechnical actions, and Set C for design of structural members involving geotechnical actions, only Set B has been implemented to date.
- Pattern loading is not taken into account.
- Prestressing actions are not covered by the National Annex so are not included in any of the combinations generated using the wizard. Combinations involving prestressing actions must be created by the user.
- EN 1991-1-1 Cl. 3.3.2 (2) notes that: "When the imposed load is considered as an accompanying action, in accordance with EN 1990, only one of the two factors ψ (EN 1990, Table A1.1) and α_n (6.3.1.2 (11)) shall be applied." Since the reduction factor, α_n is not considered as part of the load combination wizard, accompanying actions will always be factored by ψ . If the α_n factor is applied to loads manually a further reduction by ψ will also be applied.

Snow load

In relation to clause 4.1.1 (2) snow loads are taken as variable actions. Where a snow load is to be considered an accidental action (as determined per the requirements of NA to BS EN 1991-1-3:2003 [Ref. 6]) it should be assigned the accidental loadtype.

References

[Ref. 2] NA to BS EN 1990:2002+A1:2005 UK National Annex for Eurocode – Basis of structural design (including National Amendment No. 1), British Standards Institution, Chiswick, Jun 2009

[Ref. 5] NA to BS EN 1991-1-1:2002 UK National Annex to Eurocode 1: Actions on structures – Part 1-1: General Actions – Densities, self-weight, imposed loads for buildings, British Standards Institution, Chiswick, Dec 2005

[Ref. 6] NA to BS EN 1991-1-3:2003 UK National Annex to Eurocode 1: Actions on structures – Part 1-3: General Actions – Snow loads (including Corrigendum No 1), British Standards Institution, Chiswick, Jun 2007

Design Combination Options - GB 50009 - 2012

The requirements for load combinations used in the assessment of building in China are implemented in accordance with the requirements of the general code for design of buildings (GB 50009 - 2012)

Combination options

- ULS
- SLS combination
 - Short term
 - Long term

- Standard combination

Other options

- Create an envelope for each combination type** Checking this option will create an envelope for each chosen combination type.
- Advanced** Provides a design code-specific editable tabular listing of the load types and the associated factors to be considered.

Add / replace combinations

- Add / Replace** When re-running the Design Combination wizard it is possible (depending upon settings made) to add new combinations to those already present in the Analyses , or to replace (remove) all combination entries present with the currently defined ones.

Combination approach

- Basic combination** Load factors are included in the combination name for a **basic combination**.
- Smart combination** Load factors are not included in the combination name for a **smart combination** due to the variable nature of the factors.

Design Combination Options - JTG D60-2004

The requirements for load combinations used in the assessment of highway bridges in China are implemented in accordance with the requirements of the General code for design of highway bridges and culverts (JTG D60-2004)

Combination options

- ULS
- SLS combination
 - Short term
 - Long term
- Standard combination

Other options

- Create an envelope for each combination type** Checking this option will create an envelope for each chosen combination type.
- Advanced** Provides a design code-specific editable tabular listing of the load types and the associated factors to be considered.

Add / replace combinations

- Add / Replace** When re-running the Design Combination wizard it is possible (depending upon settings made) to add new combinations to those already present in the Analyses Treeview, or to replace (remove) all combination entries present with the currently defined ones.

Combination approach

- Basic combination** Load factors are included in the combination name for a **basic combination**.
- Smart combination** Load factors are not included in the combination name for a **smart combination** due to the variable nature of the factors.

Cable Tuning Analysis

Overview

LUSAS supports both linear and nonlinear cable tuning analysis in selected Bridge and Civil & Structural software products only.

- Linear cable tuning analysis** can be set-up by use of the **Analyses > Linear Cable Tuning Analysis** menu item.
- Nonlinear cable tuning loadcases** can be set-up by use of the **Analyses > Nonlinear Cable Tuning Loadcase** menu item, which will insert the new loadcase immediately after the currently selected one.

See Modelling cables for modelling options available.

Linear Cable Tuning Analysis

Overview

A linear cable tuning analysis can be set-up by use of the **Analyses > Linear Cable Tuning Analysis** menu item. This is provided in selected LUSAS Bridge and LUSAS Civil & Structural software products only.

A linear cable tuning analysis calculates load factors for selected lines in a model that represent cables in order to achieve defined target values set for various feature types and results components. Lines representing cables should be assigned a linear material, and should be meshed with only one bar or beam element per line. See *Modelling cables* for the various ways of modelling cables.

- For a linear cable tuning analysis no nonlinear controls or assignments must be present
- For a nonlinear analysis a **nonlinear cable tuning loadcase** must be defined.

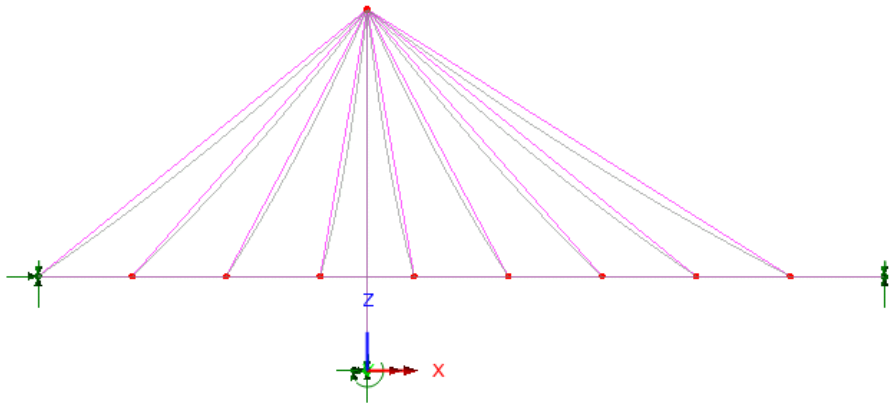

Defining a linear cable tuning analysis

Setting up a linear cable tuning analysis requires the following:





1. **Choose a solution type** An 'exact' method, an optimisation facility and two best-fit solution methods are available
2. **Define which lines represent cables for tuning purposes**
3. **Define the loadcases that will be used in the cable tuning analysis**

The Cable Tuning dialog contains tabbed pages to allow these tasks to be completed. Note that the Cable Tuning dialog is functionally similar to the Target Values dialog, with the exception that a Cables page is included to allow the selection and inclusion of lines representing cable stays.

The Cable Tuning dialog pages **Solution type**, **Cables**, **Loadcases**, **Targets** and **Optimisation criteria** should be visited to specify all data required for a linear cable tuning analysis.

Saving cable tuning parameters

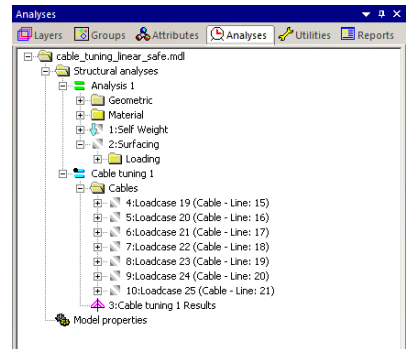

When the **OK** or **Apply** button is pressed on the Cable Tuning dialog all input is saved, even if it contains errors or inconsistencies.

If the input is valid a linear cable tuning analysis  entry will be added to the Analyses  Treeview. A Cable tuning results entry  will also be added. If the input is invalid, the invalid data icon  will appear instead, and corrective measures will be needed. See [Validating cable tuning parameters](#) for assistance.





Double-clicking a cable tuning analysis entry (or selecting **Edit** from its context menu) will show the settings used to create it.



Solving a linear cable tuning analysis

To solve a linear cable tuning analysis  either choose the **Solve Now** menu item on its context menu, or press the Solve button  on the main toolbar menu.

As part of solving these types of models a unit tensile loadcase is automatically generated for any line selected to represent a cable stay. These loadcases will be factored by the optimisation algorithm to try and achieve a solution.

When solved, cable tuning results  are held in a separate tuning analysis  entry in the Analyses  Treeview. This contains a folder with the individual solved and generated loadcases for each table, and a results loadcase (which is effectively a combination) representing the achieved target profile. Note that the loadcase naming convention used is automated and cannot be edited.

Viewing results of a linear cable tuning analysis

- Right-click on the Cable tuning results entry  and select **Set Active** to view results on a pre-defined results layer.
- Double-click on the Cable tuning results entry  to display the forces calculated for each loadcase (and hence each line representing a cable) in order to achieve the target values.

Cable tuning results options

The context menu for a Cable tuning results entry  contains the following menu items:

- ❑ **Calculated Forces** displays the forces calculated for each loadcase (and hence each line representing a cable) in order to achieve the target values. All entries in the grid are read-only.
- ❑ **Create Combination** Creates a combination containing the loadcases used in the Cable tuning results loadcase, with each loadcase factored by the values calculated by the cable tuning analysis. This allows suitable further analysis to be carried out. The menu item is greyed out unless the loadset has been solved.
- ❑ **Create Loadcase** Creates a loadcase that could be used in a nonlinear analysis. This loadcase contains the loadings used in the Cable tuning results loadcase, with each loading factored by the values calculated by the cable tuning analysis. The menu item is greyed out unless the loadset has been solved.

Superposition

When a cable stay analysis is carried out, LUSAS cannot verify that superposition holds when combinations or envelopes contain loadcases from different analyses or when nonlinear behaviour is being considered. This may occur if lift-off supports are present, or when geometric or material changes take place between analyses.

Converting cable tuning analysis data into target values data

The context menu for the Cable tuning analysis  entry contains the following menu item:





- ❑ **Create target values** - this converts the cable tuning loadset data into an equivalent target value loadset. This can then be used for further analysis and investigation using additional criteria. See [Target Values](#) for more details.

Case Study: Linear Cable Tuning Analysis

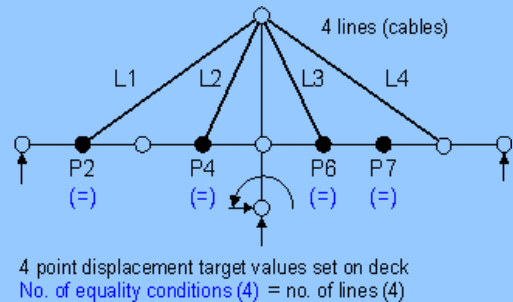
The basic procedure to carry out a linear cable tuning analysis of a simple 4-stay bridge using the **Exact** method is as follows:

1. In the model view window, select the same number of points (4) on the bridge deck as lines representing cables of interest (4) and add the lines representing the cables to the selection.



2. Select **Analyses > Linear Cable Tuning Analysis**
3. On the Cables tab press the **All** button include all the lines from the selection.
4. On the Loadcases tab press the Add to  button to include all loadcases to be used in the target value analysis.
5. On the Targets tab press the **Add Selected** button to add the 4 points previous selected.
6. Specify target criteria for those points. For example **Displacement, DZ, 0.05**.
7. Check the **Exact** solution is requested and press the **Validate** button to check the input is suitable.
8.  Solve the model.
9. Right-click on the Cable tuning Results  entry and choose **Calculated Forces** to view the forces calculated in each cable to achieve the specified target values.
10. (Optional) Right-click on the Cable tuning Results  entry and choose **Create loadcase** to create a single loadcase with loadings for each cable factored according to the calculated values.

Note that the target points (and line start/line ends) selected to define target value criteria can be for any part of a structure. For instance, target points selected do not have to be at the end of lines representing cables.

Worked Example

See Online help > Worked Examples > For LUSAS Bridge and LUSAS Civil & Structural > 'Linear cable tuning analysis of a pedestrian bridge', which shows how linear cable tuning analysis is carried out for a simple structure.

Nonlinear Cable Tuning Loadcase

Overview

The nonlinear cable tuning loadcase facility is provided in selected Bridge and Civil & Structural software products only. It is used for:

- Nonlinear analyses where geometric, material or boundary condition nonlinearity may exist.
- Staged construction modelling where a nonlinear cable tuning loadcase can be created to follow each loadcase representing a construction stage, or follow any chosen loadcase or series of loadcases.
- Modelling of catenary effects, which require a nonlinear solution to obtain equilibrium under self-weight.
- Analyses that require pre-stressed states of existing structures to be obtained.

A nonlinear cable tuning analysis calculates load factors for selected lines in a model that represent cables in order to achieve defined target values set for various results components. Lines representing cables should be assigned a linear material, and can be meshed with multiple bar or beam elements. See *Modelling cables* for the various ways of modelling cables.

For a linear analysis see [Linear cable tuning analysis](#).

Creating Nonlinear Cable Tuning Loadcases

A nonlinear cable tuning loadcase can be added to the Analyses  Treeview and set-up in the following ways:

- By selecting the **Analyses > Nonlinear Cable Tuning Loadcase** menu item
- By right-clicking on a Loadcase entry within an analysis entry in the Analyses  Treeview and selecting the **New > Loadcase...** menu item.

Defining a nonlinear cable tuning loadcase

To set-up a nonlinear cable tuning analysis loadcase:

1. **Choose a solution type** An 'exact' method, an optimisation facility and two best-fit solution methods are available.
2. **Define which lines represent cables for tuning purposes**

The Cable Tuning dialog contains tabbed pages to allow these tasks to be completed. Unlike linear cable tuning analysis, no Loadcases page is present on this dialog because loadcases do not have to be explicitly selected to be included in a nonlinear cable tuning analysis. Instead, the position of a nonlinear cable tuning loadcase within



the Analyses  Treeview will dictate which preceding loadcase is used to provide loading data for the nonlinear cable tuning analysis.

Related pages

The Cable Tuning dialog pages [Solution types](#), [Cables](#), [Targets](#) and [Optimisation criteria](#) should be visited to specify all data required for a nonlinear cable tuning analysis loadcase.

Saving cable tuning parameters

When the **OK** or **Apply** button is pressed on the Cable Tuning dialog all input is saved, even if it contains errors or inconsistencies.

If the input is valid a nonlinear cable tuning loadcase entry  will be added to the Analyses  Treeview. If the input is invalid, the invalid data icon  will appear instead, and corrective measures will be needed. See [Validating cable tuning parameters](#) for assistance.

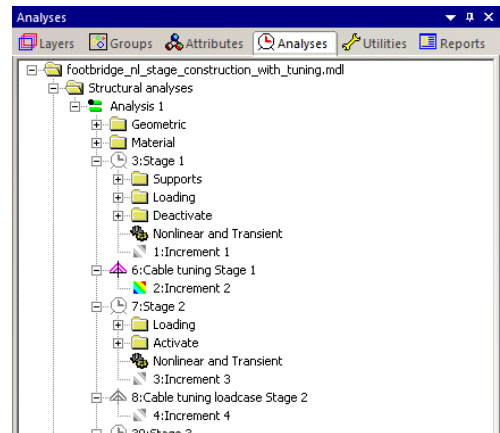

Double-clicking a cable tuning entry (or selecting Edit from its context menu) will show the settings used to create it.

Solving a nonlinear cable tuning loadcase

Nonlinear cable tuning loadcases are solved as part of the analysis within which they sit, by pressing the Solve button  on the main toolbar menu.

As part of solving these types of analyses a unit tensile loadcase is automatically generated for any line selected to represent a cable stay. These loadcases will be factored by the optimisation algorithm to try and achieve a converged solution considering the target values specified.

When solved, a nonlinear cable tuning results increment representing the achieved target profile will be added beneath the loadcase entry in the Analyses  Treeview.

Viewing results of a nonlinear cable tuning loadcase

- Right-click on the cable tuning results loadcase  and select **Set Active** to view results.

Cable tuning results options

The context menu for a cable tuning results entry  contains the following cable tuning specific menu item:

- ❑ **Calculated Forces** displays the forces calculated for the current loadcase (and hence each line representing a cable) in order to achieve the target values specified for this loadcase. All entries in the grid are read-only.

Note that unlike linear cable tuning analysis, it is not possible to ‘unwrap’ a nonlinear cable tuning loadset into a combination, or to create a loadcase using the same factors, nor apply its factors as load factors to the original input loadcases.

Superposition

When a cable stay analysis is carried out, LUSAS cannot verify that superposition holds when combinations or envelopes contain loadcases from different analyses or when nonlinear behaviour is being considered. This may occur if lift-off supports are present, or when geometric or material changes take place between analyses.

Case Study: Nonlinear Cable Tuning Analysis

The basic procedure to carry out a nonlinear cable tuning analysis of a simple 4-stay bridge using the **Exact** method is as follows:

1. If a linear cable tuning analysis has been previously been run, remove the stress and strain cable tuning load attribute from the Attributes treeview.

2. Set-up nonlinear controls by right-clicking on loadcase 1 in the Analyses treeview, and selecting Controls, then Nonlinear and Transient, using Automatic settings initially.

3. In the model view window, select the same number of points (4) on the bridge deck as lines representing cables of interest (4) and add the lines representing the cables to the selection.

4. Select **Analyses > Nonlinear Cable Tuning Loadcase**



5. On the Cables tab press the **All** button include all the lines from the selection.

6. On the Targets tab press the **Add Selected** button to add the 4 points previous selected.

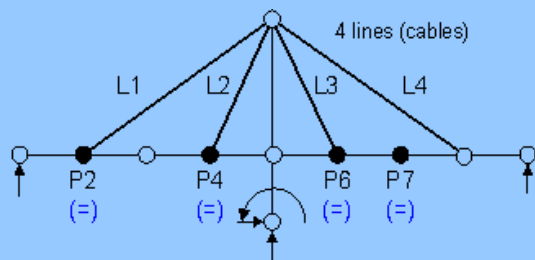
7. Specify target criteria for those points. For example **Displacement, DZ, 0.05**.



4 point displacement target values set on deck
 No. of equality conditions (4) = no. of lines (4)

8. Check the **Exact** solution is requested and press the **Validate** button to check the input is suitable.
9.  Solve the model.
10. Right-click on the Cable Tuning results  entry and choose **Calculated Forces** to view the forces calculated in each cable to achieve the specified target values.

Note that the target points (and line start/line ends) selected to define target value criteria can be for any part of a structure. For instance, points selected do not have to be at the end of lines representing cables.

Related Worked Example

See Online help > Worked Examples > For LUSAS Bridge and LUSAS Civil & Structural > 'Linear cable tuning analysis of a pedestrian bridge'

Cable tuning: Solution types

For an overview of the steps required to carry out a cable stay analysis see [Linear Cable Tuning Analysis](#) or creating a [Nonlinear Cable Tuning Loadcase](#) as appropriate.

Solution types

The choice of solution type is made on the main page of the Cable Tuning dialog.

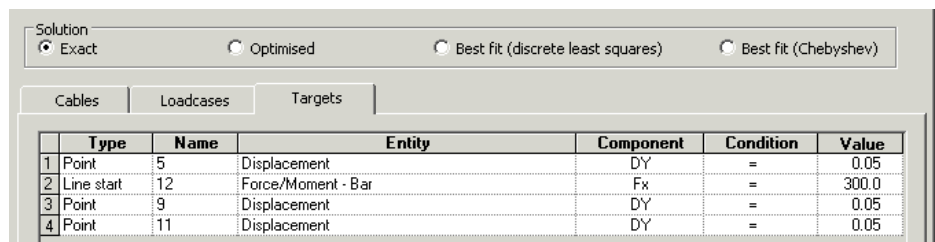

The type of cable tuning solution that can be chosen is dependent upon the number of lines selected to represent cables and the number of equality conditions specified (as seen in the Condition column on the Targets page grid). An equality condition can be set for either a point or the start or end of a line.

The solution type can be set to be:

- ❑ **Exact.** This requires the number of equality conditions (as seen in the Condition column on the Targets grid) to be the same as the number of lines (representing cables) present in the Included panel on the Cables page. No inequality conditions can be defined for the exact method. Using this option, only one solution is possible.

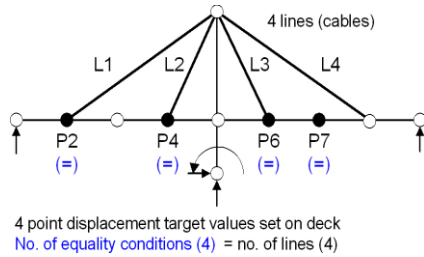

In summary: use the Exact option if there are the same number of cables and exact targets - only one set of cable tensions will meet all the criteria exactly.

See [Case study: Linear Cable Stay Analysis](#) for a basic procedure using the Exact method.

Note that the exact solution for a given set of target values may produce negative factors for some cable and loading arrangements. If this occurs an optimised solution should be investigated where all of the points of interest are permitted to move a small distance to try and achieve a better solution. In the case of Points being used to restrict displacement in a bridge deck (as shown in the accompanying images) this would amount to specifying a distance that would slacken the cables.

- ❑ **Optimised**(an under-determined solution) requires the number of equality conditions to be less than the selected number of lines (representing cables) present in the Included panel on the Cables page that are marked as having a Calculated factor. Any number of targets specifying inequality conditions can be defined. For this option a range of solutions is possible provided that they are not mutually exclusive.

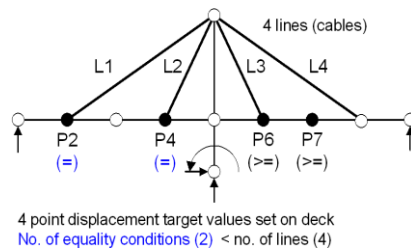

In summary: use the Optimised option if there are more cables than exact targets. Since several sets of cable tensions can meet the criteria exactly, minimum cable tensions or other optimal conditions must be specified.

Options to minimise or maximise the calculated factors for a variety of in-built or specified criteria are provided on the Optimisation criteria page..

- Best fit (discrete least squares)** and **Best fit (Chebyshev)** (both over-determined solutions) require the number of equality conditions to be greater than or equal to the selected number of lines representing cables in the Included panel on the Cables page that are marked as having a Calculated factor. Any number of targets specifying equality or inequality conditions can be defined. For this approach no unique solution is guaranteed.

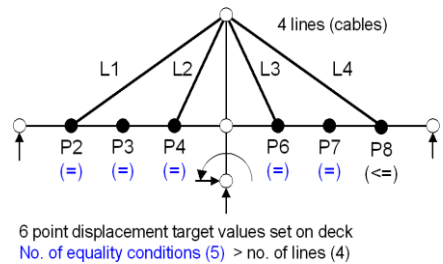

In summary: use the Best fit (least discrete squares) option or Best fit (Chebyshev) option if there are more exact targets than there are cables. No set of cable tensions can meet all the criteria exactly, but factors which minimise deviation from the targets can be found.

Grid

For non-Exact solutions only, displays the included lines representing cables and any assigned importance levels in a grid format.

Included lines

For non-exact solution types only, included lines representing cables may have an importance level assigned to them (a weighting) such that optimisation calculations may take more account of some cables than others when calculating target values - but only in an optimised solution. A default value of 1.0 is applied for each if an importance level is not specified. Numbers greater than 1 signify higher importance.

Related pages

The linear cable tuning dialog pages [Solution types](#), [Cables](#), [Loadcases](#), [Targets](#) and [Optimisation criteria](#) should be visited to specify all data required for a cable tuning analysis.

Validating cable tuning parameters

- Validate input** The Validate Input button should be used to check if the number of equality conditions and the number of lines representing cables are valid for the chosen Solution method. Three different outcomes exist:
 - Input is valid - the analysis can proceed.
 - An error message may be displayed. This may indicate an imbalance in the equality conditions and the number of lines representing cables, requiring

correction. Or it may relate to the presence of a loadcase with a nonlinear assignment of controls being present, again requiring correction.

- The message "Exact solution type required" will appear indicating that, because the number of equality conditions and number of lines representing cables is the same, an optimised or best fit solution cannot be obtained. An Exact solution should be used instead.

Identifying a feature in the grid

- **Identify selection** locates a selected feature (a point or a line) in a model. When the row for a feature is selected in the grid on the dialog, and this checkbox is 'on', the corresponding feature (point/line) is located in the View window by animating concentric shrinking squares.

Cable tuning: Defining the cables

The Cables page of the Cable Tuning dialog provides the means to specify which previously defined lines in the model, that represent cables, are to be used as loadcases in a cable tuning analysis.

For an overview of the steps required to carry out a cable stay analysis see [Linear Cable Tuning Analysis](#) or creating a [Nonlinear Cable Tuning Loadcase](#) as appropriate.

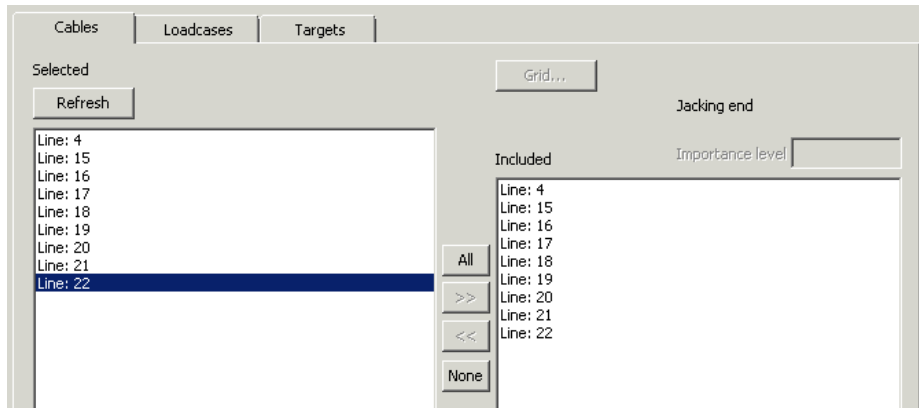

Use

Generally, the Lines representing cables should be selected in the View window prior to displaying the Cable Tuning dialog. If this is done the lines will already be present in the 'Selected' panel, ready for including in an analysis by using the Add to  button. However, the selection of features and of general Modeller menu items is also possible whilst the Cable tuning analysis dialog is displayed.

- The list of available lines can be extended/reduced simply by selecting/deselecting lines in the model and pushing the **Refresh** button.
- To include an individual Line select it in the left-hand Selected panel and click the Add to  button to add it to the right-hand **Included** panel. Use the **Shift** key to select multiple lines. Note that the same line cannot be added twice.

Any lines added to the 'Included' panel are automatically interpreted as being cables requiring the optimisation algorithm to try and achieve a solution.

For nonlinear cable tuning only

- Jacking end** For nonlinear cable tuning it is necessary to specify which end of the cable is receiving the jacking. Linear cable tuning applies an initial stress to every element in the cable, but for nonlinear, the initial stress must only be applied to the element at the chosen end(s) of the cable. Jacking end can be defined as End 1, End 2, of Both ends. The jacking control is enabled whenever a line in the 'included' panel is selected.

Cable tuning: Defining the loadcases (linear cable tuning only)

The Loadcases page of the linear cable tuning analysis dialog is similar in operation to the basic and smart combination dialog. Previously defined loadcases need to be selected for inclusion in the calculations to achieve specified target values. Each can also have a factor applied.

For an overview of the steps required to carry out a linear cable stay analysis see [Linear Cable Tuning Analysis](#).

Note that for nonlinear cable tuning analysis no Loadcases page is present on this dialog because loadcases do not have to be explicitly selected to be included in a nonlinear cable tuning analysis. Instead, the position of a nonlinear cable tuning loadcase within the Analyses  Treeview will dictate which preceding loadcase is used to provide loading data for the nonlinear cable tuning analysis.

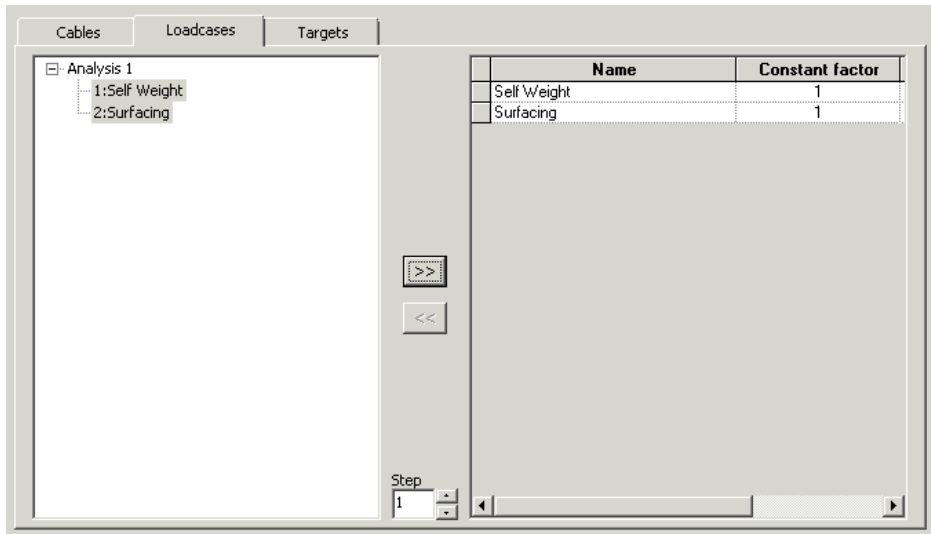

- Results can be combined from different results files if those files are open. Click in the drop-down list to select the results file. To include a results loadcase select it in the left-hand **Selected** panel and click the Add to  button to add it to the **Included** panel. Use the **Shift** key to select multiple results cases.
- Combination and Envelope loadcases are saved with the model data; click in the drop-down list to see and select the model entry.
- Combinations may include results, other combinations or envelopes as necessary (but see note regarding superposition below).
- Included loadcases can be factored by selecting the loadcase and modifying the value in the **Factor** field

Model and results loadcases included are interpreted as being **Constant**. This means that these loadcases are only used as an input to the optimisation algorithm, and they are not factored by it to try and achieve a solution.

Notes

- Loadcases with a Constant factor are considered in the optimisation, but not modified by it. There may also be other loadcases in the model which form no part of the optimisation.
- Loadcases may be factored, for both exact and non-exact solutions.
- There is no restriction on multiple combinations and envelopes that reference the same loadcase, or indeed that reference loadcases that are included in their own right. As a result there may be some permutations of loadcases for which a particular analysis solution cannot be found. Detecting a potential problem in

advance of solving is not practical, so if this should occur any error is reported after a solution has been attempted.

- When a cable stay analysis is carried out LUSAS cannot verify that superposition holds when combinations contain loadcases from different analyses or when nonlinear behaviour is being considered. This may occur if lift-off supports are present, or when geometric or material changes take place between analyses.

Cable tuning: Defining target values

This page of the Cable tuning dialog provides the means to add rows of feature type, entity and component data to a grid for comparison, row-by-row, against target values. The equality or inequality conditions available are governed by the solution type. An equality condition can be set for either a point, or the start or end of a line.

For an overview of the steps required to carry out a cable stay analysis see [Linear Cable Tuning Analysis](#) or creating a [Nonlinear Cable Tuning Loadcase](#) as appropriate.

		Cables	Loadcases	Targets			
	Type	Name	Entity	Component	Condition	Value	
1	Point	5	Displacement	DY	=	0.05	
2	Line start	12	Force/Moment - Bar	Fx	=	300.0	
3	Point	9	Displacement	DY	=	0.05	
4	Point	11	Displacement	DY	=	0.05	

Use

Model features of interest (points or lines in a geometry model, or nodes in a mesh-only model) should be selected prior to selecting the **Add Selected** button. Note that the selection of features, and of general Modeller menu items, is also possible whilst the main Cable tuning dialog is displayed.

When the Add Selected button is pressed the [Add Targets From Selection](#) dialog assists in the population of the grid by allowing feature type, entity and component selections to be made for the chosen selection of features.

- When added singly the feature name, entity and component should be chosen from the combos on the Add Selection dialog for each.
- When added for a multiple selection of features common target data can be set on the Add Selection dialog for all the similar features in the selection.

When data is already in the grid the **Add** button will duplicate the last row. When the **Add** button is used without data in the grid the feature name must be specified manually but thereafter selections can be made in the combo boxes for each column.

Checking input

- The **Validate input** button is used to check if the number of equality conditions and the number of lines representing cables are valid for the chosen Solution method.
- The **Identify selection** checkbox locates a selected feature (a point or a line) in a model. When the row for a feature is selected in the grid on the dialog, and this checkbox is 'on', the corresponding feature (point/line) is located in the View window by animating concentric shrinking squares.

Notes

- Nodes can only be selected in mesh-only models.
- If Solution type is set to **Exact** only the equals '=' condition is available.
- If Solution type is set to **Optimised** or **Best Fit** the entries in the Condition column can be set to '=', '>=' and '<='.
- Type, Entity and Component settings in the grid can be modified using the drop-down menu for each cell.
- For a linear cable tuning analysis any results components (including user-defined results) calculated by Modeller can be used as targets.
- For a nonlinear cable tuning loadcase, only those raw results components that are calculated for each element type by LUSAS Solver can be used as optimisation targets. Such results will always be in element-local directions, and cannot be transformed. Derived components such as absolutes, equivalents, principals, Wood-Armer, User Defined Results and others cannot be used.
- Types **Line start** and **Line end** are similar to specifying a **Point**, but clarify which element is to be examined, for example where multiple lines meet at a point.
- The **user defined results** facility may be used to construct components that are more complex than the standard provided components. This allows targets to be given in terms of potentially complex expressions involving components from more than one results entity.
- Points and Lines cannot be deleted from the model if they are present in a target values loadset.

Cable tuning: Optimisation criteria

This page of the Cable tuning dialog provides the means to define optional optimisation criteria based upon solution type.

For an overview of the steps required to carry out a cable stay analysis see [Linear Cable Tuning Analysis](#) or creating a [Nonlinear Cable Tuning Loadcase](#) as appropriate.

Optimisation type options

The following are shown only for the **Optimised** Solution type:

- Minimise the largest calculated factor** The calculated factor for the cable stay with the largest factor is minimised.
- Minimise sum of the calculated factors** The sum of the calculated factors for all cable stays is minimised.
- Minimise the sum of the criteria specified below** Minimises the sum of additional values (at given locations) as specified in the grid to optimise the solution.
- Maximise the sum of the calculated factors** The sum of the calculated factors for all cable stays is maximised
- Maximise the sum of the criteria specified below** Maximises the sum of additional values (at given locations) as specified in the grid to optimise the solution.

Time Management

Overview

The time management facility provides the means to manage a simple construction schedule and easily adjust the duration of pre-defined construction stages in a staged construction analysis. It can be accessed using the **Bridge> Time Management** menu item. It can also be accessed from the context menu for each analysis entry in the Analyses  Treeview.

It can be used to easily and automatically update the total response time values in nonlinear and transient controls that have been previously specified for each loadcase of a staged construction analysis.

Analysis and Start Date

- Analysis** For a selected analysis, each loadcase will appear in the time management grid in the order that they appear in the Analyses Treeview.
- Start Date** Specifying a construction start date (for the first loadcase) will set or modify the cast dates and stage dates seen on the Dates and Gantt chart tabs.







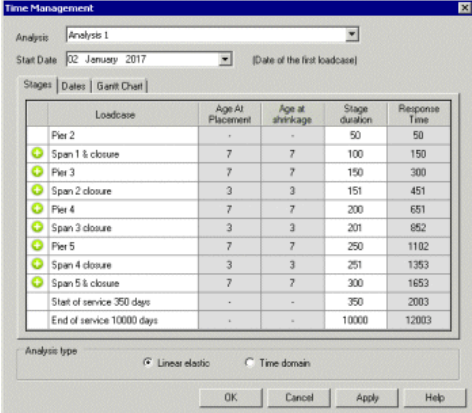

Stages

For time management purposes, a construction stage is considered to be a loadcase in which elements are activated by use of the **activate and deactivate** facility. A green 'Plus' symbol  in the first column of the grid indicates that a loadcase has been identified as a construction stage (that is, some elements are activated in it).

- ❑ **Loadcase** This column lists the names of the loadcases that are present in the Analyses Treeview.
- ❑ **Age at placement** This is taken directly from the assigned Age attribute. It is the age at activation time of the members in that construction stage. If for a particular stage of construction multiple concrete segments are added to a structure each with a different age, the word Multiple will appear. Otherwise if each segment had the same age, the single value common to all would be seen instead.
- ❑ **Age at shrinkage** This is taken directly from the assigned Age attribute. The age when shrinkage begins is used to determine the amount of shrinkage taking place in the concrete during construction stages, which excludes the shrinkage before placement.
- ❑ **Stage duration** The length of time that the loading (as defined in the loadcase) is applied for in this stage. This value can be edited in the time management grid, and if done, will automatically update the total response time value that was previously specified in the nonlinear and transient controls for each loadcase in the Analyses Treeview.
- ❑ **Response time** A cumulative value measured from the start of the analysis to the end of each loadcase.



The screenshot shows the 'Time Management' dialog box for 'Analysis 1'. It includes a 'Start Date' field set to '01 January 2017'. The main table lists various loadcases with their corresponding 'Age at Placement', 'Age at shrinkage', 'Stage duration', and 'Response Time'. The 'Response Time' values are cumulative. At the bottom, there are radio buttons for 'Linear elastic' (selected) and 'Time domain', and 'OK', 'Cancel', 'Apply', and 'Help' buttons.

Loadcase	Age At Placement	Age at shrinkage	Stage duration	Response Time
Pier 2	-	-	50	50
 Span 1 & closure	7	7	100	150
 Pier 3	7	7	150	300
 Span 2 closure	3	3	151	451
 Pier 4	7	7	200	651
 Span 3 closure	3	3	201	852
 Pier 5	7	7	250	1102
 Span 4 closure	3	3	251	1353
 Span 5 & closure	7	7	300	1653
Start of service 350 days	-	-	350	2003
End of service 10000 days	-	-	10000	12003

Notes

- For loadcases that are considered to be construction stages the age of concrete at placement and curing time will initially be populated from any assigned age attributes.
- Loadcases in which no elements are activated will also appear in the Stages grid. For these loadcases, which are considered to be an intermediate stage, no values can be provided for the concrete age, since no new elements are born.

Only a duration can be provided, and changing this will affect the Response Time of the subsequent loadcases.

- The units of time displayed in the Time Management dialog are reported in days regardless of the model's timescale units in use. Only whole days are reported because the implementation in this facility of a third-party Gantt chart that only reports in days.

Dates

The construction schedule is displayed as a series of dates.

- ❑ **Cast date** The 'Stage date' minus the 'Age at placement'.
- ❑ **Stage date** The date at which the construction stage (loadcase) starts.

The dates are determined from the stage durations provided on first tab and are used to display a Gantt Chart schedule when the Gantt Chart tab is accessed

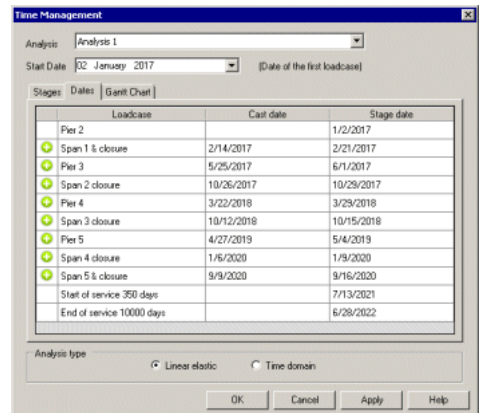

Gantt Chart

The Gantt chart shows a graphical representation of the construction schedule. Red bars show construction stages, green bars show cast/curing times.

- Show cast dates** This check box controls whether bars showing cast dates are included or excluded from the chart.
- Show relations** This check box controls whether relationship lines are included or excluded from the chart.
- Show in Pop-out** When pressed, displays the Gantt Chart in a separate window. Holding the Ctrl key down when scrolling with a mouse wheel changes the width of the columns representing each day.

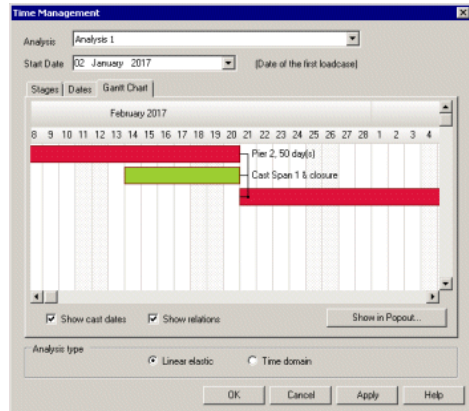

Analysis type

- Linear static** This radio button is set initially regardless of any nonlinear and transient controls being present in the Analyses treeview. When the OK button is pressed all nonlinear and transient controls will be removed making the analysis linear.
- Time domain** With this radio button selected, when the OK button is pressed all nonlinear and transient controls will be added to each loadcase in the selected analysis (if none are present), or any existing nonlinear loadcase controls will be replaced, using the Response time as stated in the time management dialog to update the total response time value that was previously specified in the nonlinear and transient controls for each loadcase.

Prestress Loading

Overview

Modelling of prestress loading is available for selected LUSAS Bridge and LUSAS Civil & Structural software products only. To model prestress loading requires the following:

1. **Definition of tendon profiles** either manually, copied and pasted from a spreadsheet, or generated by selecting lines, arcs or splines that are defined or imported into LUSAS Modeller.
2. **Definition of tendon properties** in accordance with a chosen design code.
3. **Definition of tendon loading** which associates a prestress force and associated jacking and loss details with a particular tendon profile and tendon property.
4. **Assignment of tendon loading attributes** to selected features and loadcases in a model .
5. **Solving the model** for the prestress loading applied.

Modelling time dependent effects

If time dependent effects at every stage of construction are to be evaluated then the following tasks need to be carried out prior to solving a model to calculate prestress loading:

- **Prestress parameters** (used to calculate creep effects for the post-tensioning losses) need to be defined as part of the material attribute definition and assigned to the model.
 - For linear analysis see **Material Library** for how these values can be specified for linear elastic concrete material models that support these parameters.
 - For nonlinear analysis a **concrete creep and shrinkage** model should be used.
- **Age attributes** (used to calculate creep effects for the post-tensioning losses) need to be defined and assigned to those lines in a model representing members that are cast at different times. See **Age** for details.

Solving a model with prestress loading

When solved, LUSAS calculates equivalent nodal loading from the assigned prestress tendon loads and assigns these forces automatically to selected features (and hence nodes and elements) of the model for a specified loadcase. The discrete loads and the applied forces / moments calculated can be viewed for checking purposes. See [Viewing discrete load data](#) below for details. If subsequent changes are made to a model that will affect previously calculated prestress loadings it will be necessary to solve the model again to obtain updated loading and consequential results.

Reporting on prestress loading

Tendon properties, profile, loading, losses and setting -out data for all tendons defined and assigned in a model can be reported upon by adding a [prestress results chapter](#) to a model report.



Graphing of prestress losses

Graphs showing prestress losses in tendons can be produced using the [graph wizard](#).

Editing of prestress loading and associated data

Editing of tendon loading, property and profile data can be done by individual selection of one or more attributes, or by selection of the parent folder containing a set of attributes.

Editing tendon loading

- Use the **Edit** context menu item for a tendon loading entry in the Attributes  Treeview to edit individual or multiple tendon loading assignments. Multiple selections will be edited in the [attribute editor](#).
- Use the **Edit Assignments** context menu item for a tendon loading entry in the Attributes  Treeview to edit individual or multiple tendon loading assignments in the [assignment editor](#).
- Editing of assigned tendon loadings can also be made in the Analyses  Treeview using the same 'Edit' and 'Edit Assignments' context menu items.

Editing tendon properties and tendon profiles

- Use the **Edit** context menu for a tendon property or tendon profile entry in the Utilities  Treeview.



If any changes are made to any assigned tendon loading, or to the tendon properties or tendon profile that it references, after a model has been previously solved, it will be

necessary to solve the model again to obtain updated loading and consequential results.

Viewing prestress loading data

Discrete structural loads that are calculated during the solving of prestress loading can be reproduced for checking purposes. This can be done for individual tendon loading attributes, or for a group of tendon loading attributes in a parent folder. Forces and moments calculated can also be viewed.

Creating discrete loads

- Use the **Create discrete loads** context menu item for a tendon loading attribute in the Attributes  Treeview to create copies of the discrete structural loads that are calculated during the solving of prestress loading. This creates a new analysis in the Analyses  Treeview of a name specified, with loadcases of the same names as those in the stated analysis, and as many discrete load attributes, search area attributes, and assignments as necessary to copy and represent the prestress data for the tendon loading attribute(s) selected. Any other assignments that may exist (material, geometric, etc) will also be duplicated into the new analysis – but no other loading. Tendon loads that were not selected will also be excluded. Note that any new attributes and assignments created in this way are not connected with the original tendon property data, and any changes to the original tendon property data from which they were derived has no effect on these copies.

Viewing forces and moments

- Use the **View forces and moments** context menu item for an attribute tendon load assignment selected in the Analyses  Treeview to view the discrete loading values (forces and moments) calculated by the prestress loading facility. The model must be solved before these forces can be viewed.

Updating of prestress data in pre-version 17 models

Prior to LUSAS version 17, single tendon and multiple tendon prestress wizards were used to model prestress loading. Discrete load and search area data created by these wizards was represented by attributes shown in the Attributes  Treeview. When opening these models in version 17 note that:

- Single tendon prestress wizard generated data is not converted automatically to the latest tendon modelling data structures. Tendon properties, profiles and discrete load data generated by the wizard is retained.
- Multiple tendon prestress wizard generated data is converted automatically to the latest tendon modelling data structures, with tendon properties, profiles and

loadings all being updated and assigned to the correct features. Discrete load and search area data attributes that previously revealed the underlying implementation no longer appear in the Attributes  Treeview. However, once the model is solved the discrete load data calculated can be viewed as described previously.

Worked Example

- See LUSAS Online help > Worked Examples > For LUSAS Bridge and LUSAS Civil & Structural > ‘Balanced Cantilever Construction of a Post Tensioned Bridge’, which shows the use of this facility.

Defining Tendon Properties

Tendon properties for use in a prestress analysis can be defined using the **Utilities > Prestress > Tendon Properties** menu item.

Elastic shortening due to stressing of other tendons according to the selected design code or user-defined percentage losses is taken into effect. For design codes that support it, time dependent effects can also be considered. Beam (line), shell (surface) and solid (volume) modelling of concrete is supported.

Once defined, tendon properties are stored in the Utilities  Treeview and are not directly assignable to geometry. They are referenced and used, along with **tendon profiles**, in the definition of the **tendon loading** that is defined and then assigned to features in a model.

Design codes supported

Tendon properties for which the prestress calculations will include time dependent effects for any stage of construction can be defined for:

- [AASHTO LRFD 5th to 7th Edition](#)
- [EN 1992-1-1:2004 Eurocode](#)
- [IRC:112-2011](#)

Tendon properties for which the prestress calculations will exclude time dependent effects and only produce results for short term and long term losses can be defined for:

- [AASHTO LRFD 2nd Edition](#)
- [AASHTO LRFD 5th to 7th Edition](#)
- [BS5400-4:1990](#)
- [DD EN1992-1-1:1992 Eurocode 2](#)
- [EN 1992-1-1:2004 Eurocode 2](#)
- [JTG D62-2004](#)

See the relevant design code for tendon properties related to each. This topic covers general tendon property details..

Calculation of losses

Prestress definition varies according to the design code selected, and how losses are to be calculated. Prestress losses arise from various sources: elastic shortening of the concrete, duct friction (including "wobble"), anchorage set ("slip"), creep deformations in the concrete, shrinkage of the concrete, and relaxation of the tendons. Installation losses (friction and anchorage) can be evaluated once only, whereas the remaining losses are modified, potentially, at every stage of construction. Hence, losses must be calculated appropriate to the age of the concrete and the magnitude and duration of prestress and other loading at any selected time typically at each stage, and at the end of the service life of the structure. Depending upon the Design code selected one or both of the following options may be available:

- ❑ **Losses based on time inputs and calculated stresses** allows for producing details and results of losses at any time and for any stage of construction. Note that material attributes that include prestress parameters, as well as age attributes should have been previously defined and assigned to relevant features in the model prior to using this option.
 - When using the 'Losses based on time inputs and calculated stresses' option, the elastic shortening and time-dependent losses are evaluated on a stage-by-stage, tendon-by-tendon basis, at each sampling point along each tendon. Since the losses are partly dependent upon the strain in the concrete, they are evaluated using an initial solution, that is, the LUSAS Solver runs twice, first to assess concrete stresses, from which losses can be determined, and second with the tendon loads adjusted for the losses calculated. This double-solution occurs automatically when the 'Losses based on time inputs and calculated stresses' option is chosen.
 - Elastic shortening losses are calculated in each loadcase/stage of construction at each location in each tendon, using a summation of changes in concrete stress from preceding loadcases/ stages. The simplified formulae offered in Codes Of Practice which assess total loss averaged over all tendons (assuming the tendons identical) at the end of installation is not used; instead the principles are adhered to and the calculations are appropriate to sequential tensioning.
 - Shrinkage losses are calculated in each loadcase/stage of construction at each location in each tendon, taking into account the age of the concrete component(s) through which the tendon has been installed, along with its age when the tendon was installed and the age at the onset of (drying) shrinkage. These ages are specified in the assigned 'age' attribute. Notional size of volume to surface ratio is calculated based on the assigned geometric attribute. Where necessary, the cement class and relative humidity is taken from assigned material attributes.
 - Creep losses are calculated in each loadcase/stage of construction at each location in each tendon, using a summation of changes in concrete stress

from preceding loadcases/stages and taking into account the age of the concrete component(s) through which the tendon has been installed, along with its age when the tendon was installed. Ages, geometric ratios, cement class and relative humidity is taken from the assigned attributes as described for shrinkage losses.

- Relaxation losses are calculated in each loadcase/stage of construction at each location in each tendon, based on the initial prestressing force, relaxation class and other properties of the tendon as described in the relevant 'tendon property'.
- The loss calculations themselves are carried out using the formulae found in the relevant Code Of Practices that support this calculation.

- **Approximate losses, requiring input of estimated stresses** allows for producing details and results of short term and long term losses only. This is the behaviour that was provided in LUSAS version 15.2 and earlier.

Adjustment of losses to account for prior losses

For design codes that support time-dependent loss calculations, adjustment of losses to account for prior losses is required.

For tendon loading of beam elements

- In AASHTO LRFD 7th Edition the same effect is handled by the 'transformed section coefficients', K_{id} of eqn 5.9.5.4.2a-2 and k_{df} of 5.9.5.4.3a-2.
- In EN1992-1-1 eqn 5.46, the time dependent losses are adjusted with a denominator which is to account for the fact that the 'free creep strain due to initial prestressing' isn't fully realised in a real structure because the prestress load decrements with time (due to the very losses that the prestress loss calculation is trying to determine).
- In IRC:112-2011, clause 7.9.3.3 requires that "losses due to creep and shrinkage of concrete and relaxation of steel ... should be taken into account including their time-dependency". No further information is given regarding how to adjust creep losses to account for decrement of prestress load described above. An approach similar to that in EN1992-1-1 is adopted, where the summed losses are divided using a denominator K_d which depends upon the age of the concrete at the time of tendon installation, and updates with the age of the concrete.

For tendon loading of shell and continuum elements

The adjustment factor used for tendon loading of beams cannot be applied to tendon loading of shell or continuum elements because it is reliant on beam theory and beam section properties. In shell and continuum modelling there is no closed-form link between the applied force / moment and the concrete stress. It is dependent upon the

model as a whole and the element discretisation, rather than the assumption that plane sections remain plane. As a result the adjustment factor cannot be calculated. Therefore, when using the equivalent loading method, for prestress loading, the assumption has been made that the adjustment can be neglected.

- For AASHTO, $K_{id}=K_{df}=1.0$. In test models the actual value varied between 0.99 and 0.97, indicating that this assumption would result in errors of the order 3% in the loss calculation e.g. if the time dependent losses totalled 8% including the adjustment, then removing the adjustment would result in time dependent losses totalling 8.25%.
- For EN1992-1-1, the denominator in Eqn 5.46 is taken as 1.0. In test models the actual value varied between 1.01 and 1.05, indicating that this assumption would result in errors of the order 5% in the loss calculation e.g. if the time dependent losses totalled 12% including the adjustment, then removing the adjustment would result in time dependent losses totalling 12.6%.
- For IRC:112-2011, the denominator K_d described above is taken as 1.0 on the basis of the same reasoning given for the similar approximation used for EN1992-1-1.

For all design codes, these levels of error are likely to be negligible by comparison to other assumptions inherent in the analysis.

Elastic shortening

- Selecting **Based on design code** will allow the elastic shortening to be calculated automatically with reference to the relevant clauses of the selected design code.
 - When BS5400-4:1990 is chosen in combination with the 'Based on design code' option the **Set losses...** button is enabled. This allows the average tendon force remaining after attaching subsequent tendons to be specified as a percentage of the total force. This force is applied to all loading that is assigned to the model. Clause 6.7.2.3 of BS5400 Part IV details what is required for elastic shortening.
 - For all other design codes, the **Set losses...** button is disabled, and the elastic shortening is calculated automatically with reference to the relevant clauses as stated in the following table.

Design code	Elastic shortening calculated with reference to clause
AASHTO LRFD 2nd Edition	5.9.5.2.3b
AASHTO LRFD 5th to 7th Edition	5.9.5.2.3b
DD EN1992-1-1:1992 Eurocode 2	4.2.3.5.5(6)
EN 1992-1-1:2004 Eurocode	5.10.5.1(2).
IRC:122-2011	Reference required
JTG D62-2004	Reference required

- Selecting **User-defined** allows the percentage of applied load remaining after subsequent tendons are attached to the same line to be defined. See **Elastic Shortening - Incremental** for more information.
- Selecting **Ignore effects** will not apply any elastic shortening effects to the tendons.

Defining AASHTO LRFD 5th to 7th Edition Tendon Properties with losses based upon time inputs and calculated stresses

Tendon properties and values/settings relating to instantaneous and time-dependent losses need to be defined.

All other values required in order to carry out calculations of prestress losses in accordance with the design code are obtained directly from the model.

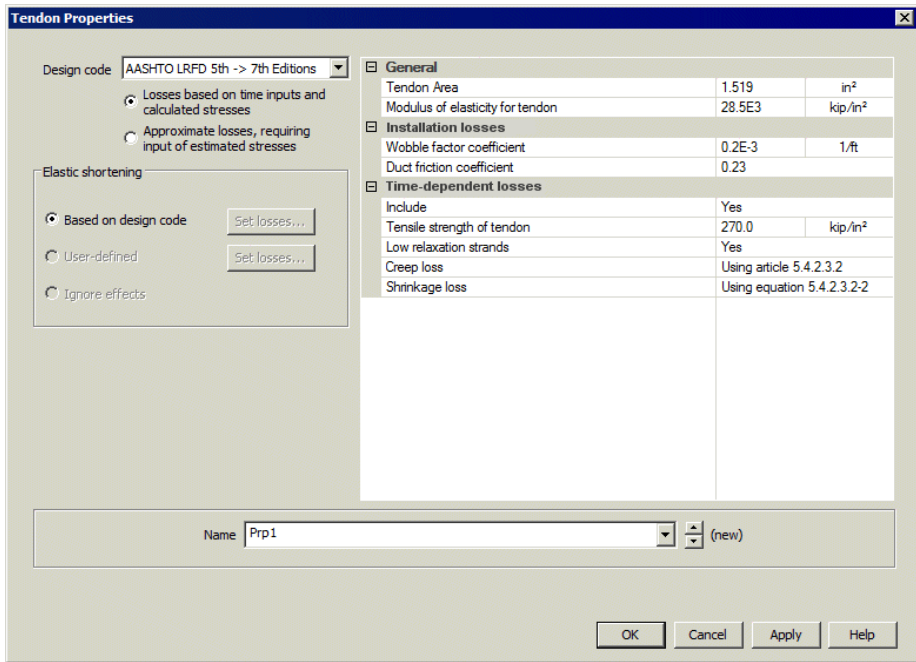

Undocumented entries

See [Defining Tendon Properties](#) for any dialog entries not covered in this topic.

General

- ❑ **Tendon area** [A_p]. The cross-sectional area of the tendon (or total area if a group is being represented by a single load assignment). In general, for internal prestressing, tendons of modest size are advisable to avoid difficulties in housing and anchoring larger tendons with the attendant increase in thickness of members and in the weight of reinforcement. 19 No 0.6” strand ($A_p=4.123\text{in}^2$) is considered to be a practical upper limit per tendon. The prestress loading facility allows tendons of larger area to be defined.
- ❑ **Modulus of elasticity for tendon** [E_p]. Refer to clause 5.4.4.2. The default value is 28,500ksi, representing strand.

Installation losses

- ❑ **Wobble friction coefficient** [K (per foot)]. This value is used in the calculation of losses due to friction according to clause 5.9.5.2.2b and also in determining anchorage losses. Values may be sought in Table 5.9.5.2.2b-1
- ❑ **Duct friction coefficient** [μ]. This value is used in the calculation of losses due to friction, according to clause 5.9.5.2.2b, and also in determining anchorage losses. Suitable values may be found in Table 5.9.5.2.2b-1; the default value μ

= 0.23 is for strand in polyethylene ducts, but is also in the suggested range for rigid and semi-rigid galvanised metal sheathing.

Post-installation losses

- Include** When set to 'Yes', prestress calculations include losses based on time inputs and calculated stresses, i.e. elastic shortening, creep, shrinkage and relaxation. When set to 'No', only installation losses are calculated, i.e. friction and anchorage.
- Tensile strength of tendon** [f_{pu}]. This value is used for the calculation of relaxation losses according to commentary eqn C5.9.5.4.2c-1. f_{py} is calculated from f_{pu} for use in that equation, using from Table 5.4.4.1-1, i.e. $F_{py} = k_p * f_{pu}$ where $k_p = 0.85$ or 0.9 for low relaxation strand. Suitable values for f_{pu} are stated in table 5.4.4.1-1.
- Low relaxation strands** When set to 'Yes', the relaxation loss is calculated using f_{py} (as described above) and $K'_L = 45$ from the commentary clause C5.9.5.4.2c. When set to 'No', the relaxation loss is calculated using $f_{py} = 0.9f_{py}$ (as described above) and $K'_L = 10$. The approximations of clause 5.9.5.4.2c, such as the use of a single value of 1.2ksi are not used for time-dependent calculations.

Creep loss

Creep loss can be calculated by one of two available methods, described below. It may be appropriate to compare the two approaches for structures which have a high sensitivity to creep loss.

- Using article 5.4.2.3.2** This option calculates creep losses using eqn 5.4.2.3.2-2 to determine k_s (the factor for the effect of the volume-to-surface ratio of the component), rather than using the alternative commentary clause. Eqn 5.4.2.3.2-2 leads to values of $k_s = 1.0$ and, in tests, gave creep losses in the expected range. This option is fully compliant with AASHTO 5th to 7th but is using an approach described in the commentary as 'an approximation' for the value of k_s .
- Using commentary and 2nd Edition** This option calculates creep losses using the commentary clause C5.4.2.3.2-2 to determine k_c , which is used in place of k_s . The commentary generally leads to values of $k_c < 1.0$ and, in tests, gave creep losses far below the expected range. Comparison with the 2nd edition identified the original use of k_c with a 3.5 multiple in the creep coefficient, rather than 1.9 as in later editions. Accordingly this option adopts the 3.5 multiple and has been found also to give creep losses in the expected range for the tests undertaken. This option is therefore not fully compliant with AASHTO 5th to 7th but may be deemed to be a more accurate approach.

Shrinkage loss

Shrinkage loss can be calculated by one of two available methods, described below. It may be appropriate to compare the two approaches for structures which have a high sensitivity to shrinkage loss.

- ❑ **Using equation 5.4.2.3.2-2** This option calculates shrinkage losses using eqn 5.4.2.3.2-2 to determine k_s (the factor for the effect of the volume-to-surface ratio of the component), rather than using the alternative commentary clause. Eqn 5.4.2.3.2-2 leads to values of $k_s=1.0$ and, in tests, gave shrinkage losses ranging from those in the expected range to those considerably larger. This option is fully compliant with AASHTO 5th to 7th but is using an approach described in the commentary as 'an approximation' for the value of k_s .
- ❑ **Using commentary** This option calculates shrinkage losses using the commentary clause C5.4.2.3.2-2 to determine k_s . The commentary generally leads to values of $k_s < 1.0$ and, in tests, gave shrinkage losses ranging from those in the expected range to those considerably lower. This option is fully compliant with the commentary approach set out in AASHTO 5th to 7th, and therefore may be deemed to be a more accurate approach, however, caution is recommended.

Defaults

- ❑ The **Defaults** button sets all previously entered values to those specified when the dialog was first displayed. Such values are illustrative only and values for use in design calculations should be checked using appropriate source data.

Notes

- Input units are the same as the current model units unless otherwise stated on the dialog. When the prestress loads are calculated the prestress forces are converted into the current model units. The current model units can be found on the status bar of LUSAS Modeller.

Notes on post-installation losses calculated to AASHTO 5th to 7th section 5.9

- Elastic losses are evaluated in accordance with the principles of article 5.9.5.2.3b, using the modulus of elasticity for concrete amended for aggregate type as per article 5.4.2.4 and amended for age and cement type using the CEB-FIP Model Code 1990 clause 2.1.6.3. The simplified formula of equation 5.9.5.2.3b-1 is not used, instead a comprehensive summation using concrete stresses from an initial solution is used.
- Creep losses are evaluated in accordance with the principles of article 5.9.5.4. Equations 5.9.5.4.2b-1 and 5.9.5.4.3b-1 are not used directly; a comprehensive summation using concrete stresses from an initial solution, and allowing calculation of shrinkage loss at any time in the analysis is adopted. The creep coefficient can be based purely upon article 5.4.2.3.2, with the factor for the effect of volume-to-surface ratio (k_s) calculated using equation 5.4.2.3.2-2 or based upon the commentary C5.4.2.3.2-1 and AASHTO 2nd edition as described earlier. In either case, coefficients k_f and k_{td} for creep are evaluated

using the f_{ci} amended for aggregate type as per article 5.4.2.4 and amended for age and cement type using the CEB-FIP Model Code 1990 clause 2.1.6.3.

- Shrinkage losses are evaluated in accordance with the principles of article 5.9.5.4. Equations 5.9.5.4.2a-1 and 5.9.5.4.3a-1 are not used directly; a generalised approach allowing calculation of shrinkage loss at any time in the analysis is adopted. The factor for the effect of volume-to-surface ratio (k_s) may be calculated using either equation 5.4.2.3.2-2 or commentary C5.4.2.3.2-2 as described earlier. In either case, coefficients k_f and k_{id} for shrinkage are evaluated using the approximation $f_{ci}=0.8*f'_c$ as f_{ci} is not properly defined in the context of shrinkage.
- Relaxation losses are evaluated using the commentary C5.9.5.4.2-c1. By comparison to course documents ACI435, AASHTO 2nd article 5.9.5.4.4b and NCHRP Report 496 eqn 63, the total relaxation loss at each stage of construction at each location along the tendon is calculated using:

$$\Delta f_{pR} = \left[\frac{f_{pt}}{K'_L} \log(24t) \left(\frac{f_{pt}}{f_{py}} - 0.55 \right) \right] \left[1 - \frac{3(\Delta f_{pS} + \Delta f_{pC})}{f_{pt}} \right] \cdot K_{id}$$

where t is the time in days since tensioning.

- For all losses, a generalised approach accounting for bending about both y- and z- axes and allowing use of unsymmetrical sections is adopted.
- When the AASHTO 'Losses based on time inputs and calculated stresses' option is used, it can be combined with the use of the Specialised CEB-FIP creep and shrinkage material in order to obtain the corresponding deformations at each time step in the analysis. The program will obtain input data from the material attributes assigned to each relevant concrete segment for use in the loss calculation - where the Specialised CEB-FIP creep and shrinkage material or Material Library AASHTO "Advanced define" material are used. This latter approach will lead to correct loss calculations but no creep deformations will be available from the analysis results.

Defining EN 1992-1-1:2004 Eurocode 2 Tendon Properties with losses based upon time inputs and calculated stresses

Tendon properties and values/settings relating to instantaneous and time-dependent losses need to be defined.

All other values required in order to carry out calculations of tendon and creep losses to in accordance with the design code are obtained directly from the model.

Design code: EN1992-1-1:2004 / 2014 Eurocode

Losses based on time inputs and calculated stresses
 Approximate losses, requiring input of estimated stresses

Elastic shortening

Based on design code (Set losses...)
 User-defined (Set losses...)
 Ignore effects

General		
Tendon Area	1.05E3	mm ²
Modulus of elasticity for tendon	195.0E6	kN/m ²

Installation losses		
Unintentional angular displacement	0.01	rad/m
Duct friction coefficient	0.19	

Post-installation losses		
Include	Yes	
Tensile strength of prestressing steel	1.86E3	N/mm ²
Relaxation class	Class 2	
Relaxation loss at 1000hrs	2.5	%

Name: Prp1 (new)

OK Cancel Apply Help

Undocumented entries

See [Defining Tendon Properties](#) for any dialog entries not covered in this topic.

Tendon details

- ❑ **Tendon area** [A_p]. The cross-sectional area of the tendon (or total area of group of strands if a group is being represented by a single load assignment). In general, for internal prestressing, tendons of modest size are advisable to avoid difficulties in housing and anchoring larger tendons with the attendant increase in thickness of members and in the weight of reinforcement. 19 No 15mm strands ($A_p=2850\text{mm}^2$) or 27 No 13mm strands ($A_p=2700\text{mm}^2$) might be a practical upper limit per tendon. The prestress loading facility allows tendons of larger area to be defined.
- ❑ **Modulus of elasticity for tendon** [E_p]. Refer to EN 1992-1-1:2004 clause 3.3.6. The default value for the modulus of elasticity, E_p is assumed to be 195GPa, representing strand. Values typically fall in the range of 185GPa to 210GPa.

Installation losses

- ❑ **Unintentional angular displacement** [k]. This value is used in the calculation of losses due to friction, according to EN1992-1-1:2004 clause 5.10.5.2, for the component sometimes referred to as “wobble” loss and also in determining

anchorage losses. k describes the “unintentional angular displacement” for internal tendons in radians per unit length. Clause 5.10.5.2(3) gives the range $0.005 < k < 0.01$ rad/m.

- Duct friction coefficient** [μ]. This value is used in the calculation of losses due to friction according to EN1992-1-1:2004 clause 5.10.5.2(1), and also in determining anchorage losses. Suitable values may be found in Table 5.1; the default value $\mu = 0.19$ is for internal tendons made up of strand filling roughly half of the duct.

Post-installation losses

- Include** When set to 'Yes', prestress calculations include losses based on time inputs and calculated stresses, i.e. elastic shortening, creep, shrinkage and relaxation. When set to 'No', only installation losses are calculated, i.e. friction and anchorage.
- Tensile strength of prestressing steel** [f_{pk}] This value is used for the calculation of $\Delta\sigma_{pr}$, the absolute value of relaxation losses to EN1992-1-1 clause 3.3.2(7) and incorporated into the time dependent loss calculation of clause 5.10.6(2).
- Relaxation Class** This is used along with f_{pk} to calculate relaxation losses. Classes 1, 2 and 3 are defined in EN1992-1-1 clause 3.3.2(4).
- Relaxation loss at 1000 hours** [ρ_{1000}]. This is used, along with f_{pk} and the Relaxation Class, to calculate relaxation losses. Typical values may be found in clause 3.3.2(6) and the default value is based on low relaxation strand (Class 2).

Defaults

The **Defaults** button sets all previously entered values to those specified when the dialog was first displayed. Such values are illustrative only and values for use in design calculations should be checked using appropriate source data.

Notes.

- Input units are to be the same as the current model units unless otherwise stated on the dialog. When the prestress loads are calculated the prestress forces are converted into the current model units. The current model units can be found on the status bar of LUSAS Modeller.

Notes on post-installation losses calculated to EN1992-1-1 section 5.10

- Elastic losses are evaluated in accordance with the principles of clause 5.10.5.1, using the secant modulus of elasticity for concrete amended for age, cement and aggregate type as per clause 3.1.3. The simplified formula of expression 5.44 is not used, instead a comprehensive summation using concrete stresses from an initial solution is used.

- Time dependent losses are evaluated in accordance with the principles of 5.10.6. The simplified method of exp 5.46 is not used directly; a generalised approach accounting for bending about both y- and z- axes and allowing use of unsymmetrical sections is adopted, together with a comprehensive summation using concrete stresses from an initial solution.
- When the Eurocode 'Losses based on time inputs and calculated stresses' option is used, it can be combined with the use of the Specialised EN1992-1-1 creep and shrinkage material in order to obtain the corresponding deformations at each time step in the analysis. The program will obtain input data from the material attributes assigned to each relevant concrete segment for use in the loss calculation - where the Specialised EN1992-1-1 creep and shrinkage material or the Material Library Eurocode "Advanced define" material are used. This latter approach will lead to correct loss calculations but no creep deformations will be available from the analysis results.

Defining IRC:112-2011 Tendon Properties with losses based upon time inputs and calculated stresses

Tendon properties and values/settings relating to instantaneous and time-dependent losses need to be defined.

All other values required in order to carry out calculations of tendon and creep losses to in accordance with the design code are obtained directly from the model.

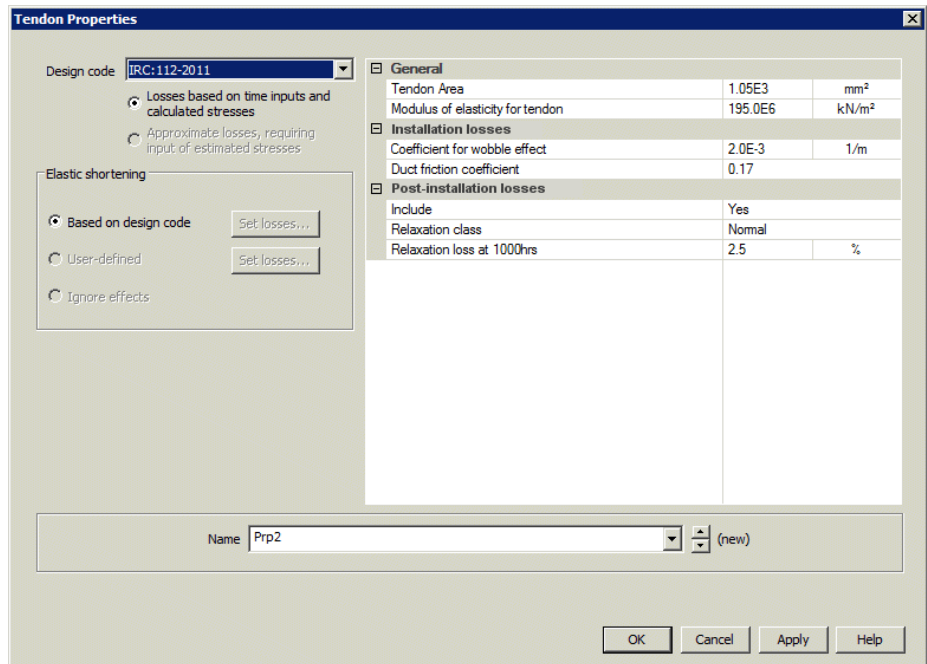

Undocumented entries

See [Defining Tendon Properties](#) for any dialog entries not covered in this topic.

Tendon details

- ❑ **Tendon area** [A_p]. The cross-sectional area of the tendon (or total area of group of strands if a group is being represented by a single load assignment). In general, for internal prestressing, tendons of modest size are advisable to avoid difficulties in housing and anchoring larger tendons with the attendant increase in thickness of members and in the weight of reinforcement. 19 No 15mm strands ($A_p=2850\text{mm}^2$) or 27 No 13mm strands ($A_p=2700\text{mm}^2$) might be a practical upper limit per tendon. The prestress loading facility allows tendons of larger area to be defined.
- ❑ **Modulus of elasticity for tendon** [E_p]. The default value for the modulus of elasticity, E_p is assumed to be 195GPa, representing strand (taken from Clause 6.3.5). Values typically fall in the range of 185GPa to 210GPa.

Installation losses

- ❑ **Coefficient for wobble effect** [k]. This value is used in the calculation of losses due to friction, and also in determining anchorage losses. k describes the “unintentional angular displacement” for internal tendons in radians per unit length. The default used is 0.002. Appropriate values from IRC:112-2011 Table 7.1 may be used in the absence of any more exact data.

- ❑ **Duct friction coefficient** [μ]. This value is used in the calculation of losses due to friction, and also in determining anchorage losses. The default value is 0.17. Appropriate values from IRC:112-2011 Table 7.1 may be used in the absence of any more exact data.

Post-installation losses

- ❑ **Include** When set to 'Yes', prestress calculations include losses based on time inputs and calculated stresses, i.e. elastic shortening, creep, shrinkage and relaxation. When set to 'No', only installation losses are calculated, i.e. friction and anchorage.
- ❑ **Relaxation Class** This is used along with [ρ_{1000}] to calculate relaxation losses. Relaxation class options are 'Low Relaxation', 'Normal' and 'Other'.
- ❑ **Relaxation loss at 100 hours** [ρ_{100}]. (Only available if Relaxation Class 'Other' is selected). This is used, along with [ρ_{1000}] and the Relaxation Class, to calculate relaxation losses. The default value of 1.8% is based on low relaxation.
- ❑ **Relaxation loss at 1000 hours** [ρ_{1000}]. This is used, along with the Relaxation Class, and optionally with [ρ_{100}] to calculate relaxation losses. The default value of 2.5% is based on low relaxation.

Defaults

- ❑ The **Defaults** button sets all previously entered values to those specified when the dialog was first displayed. Such values are illustrative only and values for use in design calculations should be checked using appropriate source data.

Notes

- Input units are to be the same as the current model units unless otherwise stated on the dialog. When the prestress loads are calculated the prestress forces are converted into the current model units. The current model units can be found on the status bar of LUSAS Modeller.

Notes on post-installation losses calculated to IRC:112-2011 section 7.9.3

- Elastic losses are evaluated in accordance with the principles of 7.9.3.2(1), using the secant modulus of elasticity for concrete amended for age, cement and aggregate type. A comprehensive summation using concrete stresses from an initial solution is used.
- Time dependent losses are evaluated in accordance with the principles of Eq 6.8, clauses 6.4.2.5 to 6.4.2.7 and Annexure A-2 and first principles. A generalised approach accounting for bending about both y- and z- axes and allowing use of unsymmetrical sections is adopted, together with a comprehensive summation using concrete stresses from an initial solution.

- When the 'Losses based on time inputs and calculated stresses' option is used, it must be used with either the Specialised IRC:112-2011 creep and shrinkage material, or the Material Library IRC:112-2011 'Advanced define' material, in order to obtain the corresponding deformations at each time step in the analysis. LUSAS will obtain input data from the material attributes assigned to each relevant concrete segment for use in the loss calculation. This approach will lead to correct loss calculations but no creep deformations will be available from the analysis results.

Defining AASHTO LRFD 2nd Edition Tendon Properties with approximate losses, requiring input of estimated stresses

Tendon properties, including instantaneous and long term losses to be defined.

Tendon Properties

Design code: **AASHTO LRFD 2nd Edition**

Losses based on time inputs and calculated stresses
 Approximate losses, requiring input of estimated stresses

Elastic shortening

Based on design code
 User-defined
 Ignore effects

General		
Tendon Area	1.519	in ²
Modulus of elasticity for tendon	28.5E3	kip/in ²
Concrete stress at transfer	1.75	kip/in ²
Short term losses		
Modulus of elasticity of concrete at transfer	3.644E3	kip/in ²
Wobble factor coefficient	0.2E-3	1/ft
Duct friction coefficient	0.23	
After transfer		
Include	Yes	
Relative humidity	70.0	%
Change in stress due to loads after transfer	-0.44	kip/in ²
Low relaxation strands	Yes	

Name: (new)

OK Cancel Apply Help

Undocumented entries

See [Defining Tendon Properties](#) for any dialog entries not covered in this topic.

General

- ❑ **Tendon area** [A_{ps}]. In general, for internal prestressing, tendons of modest size are advisable, to avoid difficulties in housing and anchoring larger tendons with the attendant increase in thickness of members and in the weight of reinforcement. 19 No 0.6" strand ($A_{ps}=4.123\text{in}^2$) is considered to be a practical upper limit per tendon. The prestress loading facility allows tendons of larger area to be defined.
- ❑ **Modulus of elasticity for tendon** [E_p]. Refer to AASHTO 2nd clause 5.4.4.2. The default value is 28,500ksi, representing strand.
- ❑ **Concrete stress at transfer** [f_{cgp}]. This value is used for the calculation of elastic shortening losses according to AASHTO 2nd eqn 5.9.5.2.3b-1 and, when long-term losses are requested, for creep losses using eqn 5.9.5.4.3-1. Creep losses are based on a single value of f_{cgp} for each tendon (combined with Δf_{cdp} below as appropriate), and the elastic shortening losses are based on a single f_{cgp} value for each member (calculated from the values given for all the applicable tendons). The value entered for f_{cgp} here should be the stress in the concrete adjacent to the tendon in question, immediately after tensioning and anchoring, due to total prestressing forces and self-weight, at the section of peak moment. Variations in stress arising from permanent actions applied after prestressing (generally but not exclusively leading to elastic shortening gains) are not incorporated in the calculation of initial elastic shortening loss.

Instantaneous losses

- ❑ **Modulus of elasticity for concrete at transfer** [E_{ci}]. This value is used for the calculation of elastic shortening losses according to AASHTO 2nd eqn 5.9.5.2.3b-1. It may be derived from the formula given in clause 5.4.2.4 (substituting f'_{ci} in place of f'_c). In the apparent absence of guidance on values for f'_{ci} in AASHTO 2nd, AASHTO 5th clause 5.4.2.3.2, states f'_{ci} may be taken as $0.8f'_c$ if the concrete age at the time of initial load is unknown during design. A likely range of values is considered to be $E_{ci} = 2522 - 5148\text{ksi}$.
- ❑ **Wobble factor** [K] (per foot). This value is used in the calculation of losses due to friction according to AASHTO 2nd clause 5.9.5.2.2b, and also in determining anchorage losses. Values may be sought in Table 5.9.5.2.2b-1.
- ❑ **Duct friction coefficient** [μ]. This value is used in the calculation of losses due to friction, according to AASHTO 2nd clause 5.9.5.2.2b, and also in determining anchorage losses. Values may be found in Table 5.9.5.2.2b-1; the default value $\mu = 0.23$ is for strand in polyethylene ducts, but is also in the suggested range for rigid and semi-rigid galvanised metal sheathing.

Long term losses

- ❑ **Include** When set to 'Yes', prestress loss calculations are based upon approximate losses, requiring input of estimated stresses. When set to 'No', only short term losses are calculated, with elastic shortening based upon calculated losses.

- ❑ **Relative humidity [H]**. This value is used in the calculation of losses due to shrinkage to AASHTO 2nd clause 5.9.5.4.2. H is defined as the “average annual ambient relative humidity (percent)” and guidance can be found in Figure 5.4.2.3.3-1.
- ❑ **Change in stress due to loads after transfer Δf_{cdp}** . This value is used for the calculation of the creep losses according to AASHTO 2nd eqn 5.9.5.4.3-1 and is defined in the code as the “change in concrete stress at centre of gravity of prestressing steel due to permanent loads with the exception of the load acting at the time the prestressing force is applied”. Applied loads and long-term losses generally oppose the initial prestress which dominates f_{cgp} and so creep effects arising from Δf_{cdp} are subtracted from those arising from f_{cgp} in eqn 5.9.5.4.3-1. Therefore where Δf_{cdp} represents a reduction in stress from f_{cgp} , a positive value for Δf_{cdp} should be entered into eqn 5.9.5.4.3-1 and this dialog. As in the case of f_{cgp} , a value appropriate to the concrete adjacent to the tendon in question may be used.
- ❑ **Low relaxation strands** When set to 'Yes', 30% of the value from eqn 5.9.5.4.4c-2 is used in line with the provisions of clause 5.9.5.4.4c. When set to 'No' relaxation losses are calculated according to AASHTO 2nd eqn 5.9.5.4.4c-2.

Defaults

The **Defaults** button sets all previously entered values to those specified when the dialog was first displayed. Such values are illustrative only and values for use in design calculations should be checked using appropriate source data.

Notes

- The prestress definition dialog expects input units to be the same as the current model unless otherwise stated on the dialogs. When the prestress loads are calculated the prestress forces are converted into the current model units. The current model units can be found on the status bar of LUSAS Modeller.
- An approximate check that the specified jacking force is suitable for the tensile strength of commonly available strand is carried out by the wizard but the user should refer to the relevant design code and manufacturers information for the strand strengths and any applicable factors in order to ensure that the tendons are not overstressed.

Defining AASHTO LRFD 5th - 7th Edition Tendon Properties with approximate losses, requiring input of estimated stresses

Tendon properties including instantaneous and long term losses need to be defined.

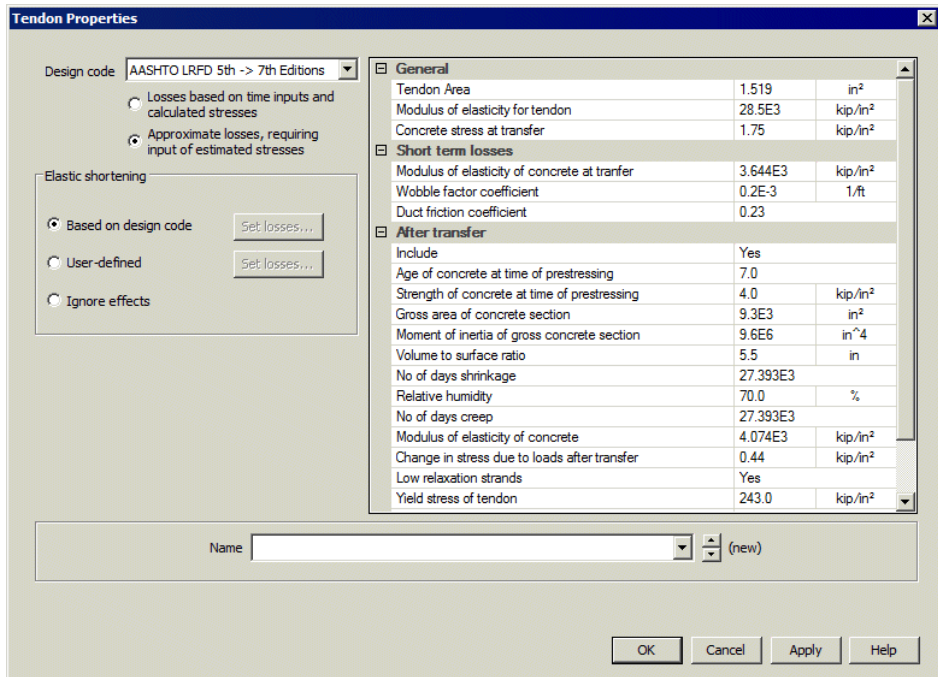

Undocumented entries

See [Defining Tendon Properties](#) for any dialog entries not covered in this topic.

General

- ❑ **Tendon area** [A_p]. The cross-sectional area of the tendon (or total area if a group is being represented by a single load assignment). In general, for internal prestressing, tendons of modest size are advisable to avoid difficulties in housing and anchoring larger tendons with the attendant increase in thickness of members and in the weight of reinforcement. 19 No 0.6" strand ($A_p=4.123\text{in}^2$) is considered to be a practical upper limit per tendon. However, tendons of larger area may be defined.
- ❑ **Modulus of elasticity for tendon** [E_p]. Refer to clause 5.4.4.2. The default value is 28,500ksi, representing strand.
- ❑ **Concrete stress at transfer** [f_{cgp}]. This value is used for the calculation of elastic shortening losses according to equation 5.9.5.2.3b-1 and, when long-term losses are requested, for creep losses using eqn 5.9.5.4.3b-1. Creep losses are based on a single value of f_{cgp} for each tendon (combined with Δf_{cd} , below, as appropriate), and elastic shortening losses based on a single f_{cgp} value for each member (calculated from the values given for all the applicable tendons). The value entered for f_{cgp} here should be the stress in the concrete adjacent to

the tendon in question, immediately after tensioning and anchoring, due to total prestressing forces and self-weight at the section of peak moment. Variations in stress arising from permanent actions applied after prestressing (generally, but not exclusively, leading to elastic shortening gains) are not incorporated into the calculation of initial elastic shortening loss.

Instantaneous losses

- ❑ **Modulus of elasticity for concrete at transfer** [E_{ci}]. This value is used for the calculation of elastic shortening losses according to equation 5.9.5.2.3b-1. It may be derived from the formula given in clause 5.4.2.4 (substituting f'_{ci} in place of f'_c). According to clause 5.4.2.3.2, f'_{ci} may be taken as $0.8f'_c$ if the concrete age at the time of the initial load is unknown at the design stage. A likely range of values would be $E_{ci} = 2525 - 5422\text{ksi}$.
- ❑ **Wobble friction coefficient** [K (per foot)]. This value is used in the calculation of losses due to friction according to clause 5.9.5.2.2b and also in determining anchorage losses. Values may be sought in Table 5.9.5.2.2b-1
- ❑ **Duct friction coefficient** [μ]. This value is used in the calculation of losses due to friction, according to clause 5.9.5.2.2b, and also in determining anchorage losses. Suitable values may be found in Table 5.9.5.2.2b-1; the default value $\mu = 0.23$ is for strand in polyethylene ducts, but is also in the suggested range for rigid and semi-rigid galvanised metal sheathing.

Long term losses

- ❑ **Include** When set to 'Yes', prestress loss calculations are based upon approximate losses, requiring input of estimated stresses. When set to 'No', only short term losses are calculated, with elastic shortening based upon calculated losses.
- ❑ **Age of concrete at time of prestressing** [t_i]. This value is used for the calculation of losses due to creep to clause 5.9.5.4.3b.
- ❑ **Strength of concrete at time of prestressing** [f'_{ci}]. This value is used in the calculation of losses due to creep to clause 5.9.5.4.3b. f'_{ci} is defined as the “specified compressive strength of the concrete at the time of initial loading or prestressing; nominal concrete strength at time of application of tendon force (ksi)”. According to clause 5.4.2.3.2, f'_{ci} may be taken as $0.8f'_c$ if concrete age at time of initial load is unknown at design stage.
- ❑ **Gross area of concrete section** [A_c], and **Moment of inertia of gross concrete section**, [I_c]. These values are used for the calculation of losses due to shrinkage, to clause 5.9.5.4.3a, and creep, to clause 5.9.5.4.3b. Where the concrete section varies, suitable intermediate values may be required.
- ❑ **Volume to surface ratio** [V/S]. This value is used in the calculation of losses due to shrinkage to clause 5.9.5.4.3a, and creep, to clause 5.9.5.4.3b. Details on how the ratio should be calculated are given in clause 5.4.2.3.2.
- ❑ **No of days shrinkage** [t]. This value is used for the calculation of losses due to shrinkage to clause 5.9.5.4.3a. t is defined as the “number of days between end

of curing and time being considered for analysis of shrinkage effects”. The default value is based on the design life for a bridge, which is 75 years according to clause 1.2.

- ❑ **Relative humidity [H]**. This value is used in the calculation of losses due to shrinkage, to clause 5.9.5.4.3a, and creep, to clause 5.9.5.4.3b. H is defined as the “average ambient mean relative humidity (percent)” and guidance can be found in Figure 5.4.2.3.3-1.
- ❑ **No of days creep [t]**. This value is used for the calculation of losses due to creep to clause 5.9.5.4.3b. t is defined as the “no of days between application of load and time considered for creep calculation”. The default value is based on the design life for a bridge, which is 75 years, according to clause 1.2.
- ❑ **Modulus of elasticity of concrete [E_c]**. This value is used for the calculation of losses due to creep to clause 5.9.5.4.3b. E_c may be calculated for a given concrete grade from the equation in clause 5.4.2.4.
- ❑ **Change in stress due to loads after transfer [Δ_{fcd}]**. This value is used for the calculation of the creep losses according to equation 5.9.5.4.3b-1, and is defined in the code as the “change in concrete stress at centroid of prestressing strands due to long-term losses between transfer and deck placement, combined with deck weight and superimposed loads”. In fact, a value appropriate to the concrete adjacent to the tendon in question may be used. Δ_{fcd} is generally negative since applied loads and long-term losses oppose the initial prestress that dominates f_{cgp} .
- ❑ **Low relaxation strands** When set to 'Yes', the relaxation loss $\Delta f_{pR1} = 1.2\text{ksi}$ is assumed according to clause 5.9.5.4.2c, and the grid entries 'Yield stress of tendon' and 'Factor accounting for type of steel' are unavailable. If this assumption is deemed inappropriate, selecting 'No' will add the entries 'Yield stress of tendon' and 'Factor accounting for type of steel' to the grid and permit specification of suitable values.
- ❑ **Yield stress of tendon [f_{py}]**. (Option only available with 'Low relation strands' set to 'Yes'.) This value is used for the calculation of relaxation losses according to equation 5.9.5.4.2c-1. f_{py} is defined as “yield stress of prestressing steel.”. Suitable values may be based on clause 5.4.4.1.
- ❑ **Factor accounting for type of steel [K_L]**. (Option only available with 'Low relation strands' set to 'Yes'.) This value is used for the calculation of relaxation losses according to equation 5.9.5.4.2c-1, when the assumption of $\Delta f_{pR2} = \Delta f_{pR1} = 1.2\text{ksi}$ is deemed inappropriate. K_L is defined as “factor accounting for type of steel, taken as 30 for low relaxation strands and 7 for other prestressing steel, unless more accurate manufacturer’s data is available.”.

Defaults

- ❑ The **Defaults** button sets all previously entered values to those specified when the dialog was first displayed. Such values are illustrative only and values for use in design calculations should be checked using appropriate source data.

Notes

- The prestress definition dialog expects input units to be the same as the current model unless otherwise stated on the dialogs. When the prestress loads are calculated the prestress forces are converted into the current model units. The current model units can be found on the status bar of LUSAS Modeller.

Defining BS5400-4:1990 Tendon Properties with approximate losses, requiring input of estimated stresses

Tendon properties, including instantaneous and long term losses to be defined.

Tendon Properties		
Design code	BS5400-4:1990	
<input type="radio"/> Losses based on time inputs and calculated stresses <input checked="" type="radio"/> Approximate losses, requiring input of estimated stresses <input type="radio"/> Elastic shortening		
<input checked="" type="radio"/> Based on design code <input type="button" value="Set losses..."/> <input type="radio"/> User-defined <input type="button" value="Set losses..."/> <input type="radio"/> Ignore effects		
General	Tendon Area	1.0E3 mm ²
	Modulus of elasticity	200.0E6 kN/m ²
Short term losses	Wobble factor	3.3E-3 1/m
	Duct friction coefficient	0.55
Long term losses	Include	Yes
	Relaxation loss	2.5 %
	Shrinkage coefficient	0.2E-3
	Creep coefficient	36.0E-9 m ² /kN
	Stress at transfer	15.0E3 kN/m ²
Name: [] (new)		
<input type="button" value="OK"/> <input type="button" value="Cancel"/> <input type="button" value="Apply"/> <input type="button" value="Help"/>		

Undocumented entries

See [Defining Tendon Properties](#) for any dialog entries not covered in this topic.

Tendon details

- Tendon area** The cross-sectional area of the tendon (or total area of group of strands if a group is being represented by a single load assignment)

- Modulus of elasticity**

Instantaneous losses

- Wobble factor** is defined per metre length and should be obtained from design code.
- Duct friction coefficient** should be obtained from design code.

Long term losses

- Include** When set to 'Yes', prestress loss calculations are based upon approximate losses, requiring input of estimated stresses. When set to 'No', only short term losses are calculated, with elastic shortening based upon calculated losses.
- Relaxation loss** is a percentage of the prestress force.
- Shrinkage Coefficient**
- Creep coefficient**
- Stress at transfer** Compressive stress in the concrete adjacent to the tendon due to prestress loading only, averaged along the length of the tendon.

Defaults

The **Defaults** button sets all previously entered values to those specified when the dialog was first displayed.

Notes

- Input units are the same as the current model units unless otherwise stated on the dialog. When the prestress loads are calculated the prestress forces are converted into the current model units. The current model units can be found on the status bar of LUSAS Modeller.

Defining DD EN1992-1-1:1992 Eurocode 2 Tendon Properties with approximate losses, requiring input of estimated stresses

Tendon properties, including instantaneous and long term losses to be defined.

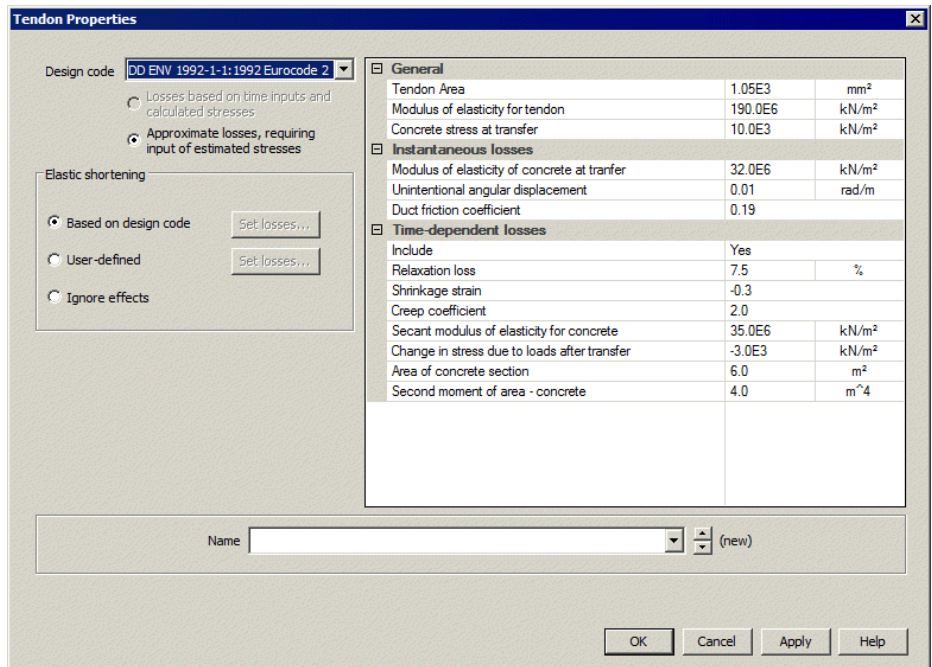

Undocumented entries

See [Defining Tendon Properties](#) for any dialog entries not covered in this topic.

Tendon details

- ❑ **Tendon area** [A_p]. The cross-sectional area of the tendon (or total area of group of strands if a group is being represented by a single load assignment). In general, for internal prestressing, tendons of modest size are advisable to avoid difficulties in housing and anchoring larger tendons with the attendant increase in thickness of members and in the weight of reinforcement. 19 No 15mm strands ($A_p=2850\text{mm}^2$) or 27 No 13mm strands ($A_p=2700\text{mm}^2$) might be a practical upper limit per tendon. The prestress loading facility allows tendons of larger area to be defined.
- ❑ **Modulus of elasticity of tendon** [E_s]. Refer to DD ENV 1992-1-1 clause 3.3.4.4 (2). The default value for the modulus of elasticity, E_s , is assumed to be 190kN/mm^2 , representing strand. Values typically fall in the range of 185kN/mm^2 to 210kN/mm^2 .
- ❑ **Concrete stress at transfer** [σ_{co}]. This value is used for the calculation of elastic shortening losses to DD ENV 1992-1-1 clause 4.2.3.5.5(6) and, when long-term losses are requested, the creep component of time-dependent losses to clause 4.2.3.5.5(9) eqn 4.10. Creep losses are based on a single value of σ_{co}

for each tendon (combined with $\Delta\sigma_{eg}$ below, defined as appropriate), and the elastic shortening losses are based on a single σ_{co} value for each member (calculated from the values given for all the applicable tendons). The value entered for σ_{co} here should be the stress in the concrete adjacent to the tendon in question, immediately after tensioning and anchoring, due to total prestressing forces and self-weight averaged along the length of the tendon. Variations in stress arising from permanent actions applied after prestressing (generally but not exclusively leading to elastic shortening gains) are not incorporated in the calculation of initial elastic shortening loss.

Instantaneous losses

- ❑ **Modulus of elasticity of concrete at transfer** [$E_{cm(t)}$]. This value is used for the calculation of elastic shortening losses to DD ENV1992-1-1 clause 4.2.3.5.5(6). This is the secant modulus of elasticity for concrete, adjusted for concrete age at the time of application of the load, under the provisions of DD ENV 1992-1-1 clause 3.1.2.5.2(4). There are no formulae for the strength of concrete developing with time in DD ENV 1992-1-1, therefore reference may be made to the CEB-FIP Model Code 1990, clauses 2.1.6.1 and 2.1.3.2, or EN1992-1-1:2004 clause 3.1.2. A likely range of values would be 24-37kN/mm².
- ❑ **Unintentional angular displacement** [k]. This value is used in the calculation of losses due to friction, according to DD ENV1992-1-1 clause 4.2.3.5.5(8), for the component sometimes referred to as “wobble” loss. It is also used in the calculation of anchorage losses. k is defined as “unintentional angular displacement (per unit length) related to the profile of the tendons”. Clause 4.2.3.5.5(8) gives a range of $0.005 < k < 0.01$ /m.
- ❑ **Duct friction coefficient** , μ . This value is used in the calculation of losses due to friction, according to DD ENV 1992-1-1 clause 4.2.3.5.5(8). It is also used in the calculation of anchorage losses. Suitable values may be found in clause 4.2.3.5.5(8); the default value $\mu = 0.19$ is for internal tendons made up of strand filling roughly half of the duct.

Long term losses

- ❑ **Include** When set to 'Yes', prestress loss calculations are based upon approximate losses, requiring input of estimated stresses. When set to 'No', only short term losses are calculated, with elastic shortening based upon calculated losses.
- ❑ **Relaxation loss** [p_r]. This value is used for the calculation of $\Delta\sigma_{pr}$, the absolute value of relaxation loss, which is incorporated into the time dependent loss calculation of DD ENV 1992-1-1 eqn 4.10. According to clause 4.2.3.4.1(2), the long term value of the relaxation loss may be assumed to be three times the relaxation losses after 1000h, which may in turn be taken from Figure 4.8, dependent upon the ratio of the applied prestress to the tensile strength of the tendons and the type of prestressing steel in use. Typical values for class 2 (strand) would therefore be (from Figure 4.8);

- $\sigma_p/f_{pk} = 0.6$; $\rho_{1000} = 1\%$; $\rho_{\infty} = 3\%$
- $\sigma_p/f_{pk} = 0.7$; $\rho_{1000} = 2.5\%$; $\rho_{\infty} = 7.5\%$
- $\sigma_p/f_{pk} = 0.8$; $\rho_{1000} = 4.5\%$; $\rho_{\infty} = 13.5\%$

- ❑ **Shrinkage strain** [$\varepsilon_s(t,t_0)$]. This value is used in the calculation of losses due to shrinkage according to DD ENV 1992-1-1 clause 4.2.3.5.5(9). $\varepsilon_s(t,t_0)$ is “the estimated shrinkage strain, derived from the values in Table 3.4 for final shrinkage (see also 2.5.5 and Appendix 1)” and should be specified “per mil” (‰) in accordance with the code (rather than actual strain).
- ❑ **Creep coefficient** [$\varphi(t,t_0)$]. This value is used in the calculation of losses due to creep, according to DD ENV 1992-1-1 clause 4.2.3.5.5(9). Clause 1.7.4 describes $\varphi(t,t_0)$ as the “Creep coefficient, defining creep between times t and t_0 , related to elastic deformation at 28 days”. Clause 4.2.3.5.5(9) refers to clause 2.5.5 that in turn refers to clause 3.1 or (for greater accuracy) Appendix 1. If greater accuracy is not required, a value for $\varphi(\infty,t_0)$ may be obtained from Table 3.3, dependent upon notional size, relative humidity and maturity of the concrete when the load is first applied.
- ❑ **Secant modulus of elasticity of concrete** [E_{cm}]. This value is used for the calculation of time-dependent losses according to DD ENV 1992-1-1 clause 4.2.3.5.5(9). Equation 4.10 requires a modular ratio, $\alpha = E_s/E_{cm}$, where E_{cm} can be obtained from Table 3.2. A likely range of values would be 29-37kN/mm².
- ❑ **Change in stress due to loads after transfer** $\Delta\sigma_{cg}$. This is used to adjust the concrete stress at transfer, σ_{co} , to account for stress in the concrete due to permanent loads applied after prestressing. $\sigma_{co} + \Delta\sigma_{cg}$ gives the concrete stress appropriate for the calculation of the creep component of time-dependent losses according to DD ENV 1992-1-1 clause 4.2.3.5.5(9), eqn 4.10 that is $\sigma_{co} + \Delta\sigma_{cg} = (\sigma_{cg} + \sigma_{cpo})$. $\Delta\sigma_{cg}$ is typically negative, since applied loads oppose the prestress that dominates σ_{co} .
- ❑ **Area of concrete section** [A_c] and **Second moment of area – concrete** [I_c]. These values are used for the calculation of time-dependent losses, according to DD ENV 1992-1-1 clause 4.2.3.5.5(9) eqn 4.10. Where the concrete section varies, suitable intermediate values may be required. If the member is a standalone beam element the area of the beam should be used. If the beam member represents part of a larger structure (for example a certain width of slab) then only the area of the portion represented by this particular beam member should be used. Please note that the prestress loading facility is designed to work for a single beam member, not for a subdivided portion of slab or wide beam element, so using it in any other way is at the engineer’s judgement.

Defaults

The **Defaults** button sets all previously entered values to those specified when the dialog was first displayed. Such values are illustrative only and values for use in design calculations should be checked using appropriate source data.

Notes.

- Input units are the same as the current model units unless otherwise stated on the dialog. When the prestress loads are calculated the prestress forces are converted into the current model units. The current model units can be found on the status bar of LUSAS Modeller.

Defining EN 1992-1-1:2004 Eurocode 2 Tendon Properties with approximate losses, requiring input of estimated stresses

Tendon properties, including instantaneous and long term losses to be defined.

Design code: EN1992-1-1:2004 / 2014 Eurocode

Losses based on time inputs and calculated stresses
 Approximate losses, requiring input of estimated stresses

Elastic shortening

Based on design code (Set losses...)
 User-defined (Set losses...)
 Ignore effects

General		
Tendon Area	1.05E3	mm ²
Modulus of elasticity for tendon	195.0E6	kN/m ²
Installation losses		
Unintentional angular displacement	0.01	rad/m
Duct friction coefficient	0.19	
Post-installation losses		
Include	Yes	
Tensile strength of prestressing steel	1.86E3	N/mm ²
Relaxation class	Class 2	
Relaxation loss at 1000hrs	2.5	%

Name: Prp1 (new)

OK Cancel Apply Help

Undocumented entries

See [Defining Tendon Properties](#) for any dialog entries not covered in this topic.

Tendon details

- ❑ **Tendon area** [A_p]. The cross-sectional area of the tendon (or total area of group of strands if a group is being represented by a single load assignment). In general, for internal prestressing, tendons of modest size are advisable to avoid difficulties in housing and anchoring larger tendons with the attendant increase in thickness of members and in the weight of reinforcement. 19 No 15mm strands ($A_p=2850\text{mm}^2$) or 27 No 13mm strands ($A_p=2700\text{mm}^2$) might be a practical upper limit per tendon. The prestress loading facility allows tendons of larger area to be defined.
- ❑ **Modulus of elasticity for tendon** [E_p]. Refer to EN 1992-1-1:2004 clause 3.3.6. The default value for the modulus of elasticity, E_p is assumed to be 195GPa, representing strand. Values typically fall in the range of 185GPa to 210GPa.
- ❑ **Concrete stress at transfer** [$\Delta\sigma_c(t)$]. This value is used for the calculation of elastic shortening losses, according to EN1992-1-1 clause 5.10.5.1(2), and, when long-term losses are requested, for the creep component of time-dependent losses, to clause 5.10.6(2). Creep losses are based on a single value of $\Delta\sigma_c(t)$ for each tendon (combined with $\Delta\sigma_{cg}$ below as appropriate), and the elastic shortening losses are based on a single $\Delta\sigma_c(t)$ value for each member (calculated from the values given for all the applicable tendons). The value entered for $\Delta\sigma_c(t)$ here should be the stress in the concrete adjacent to the tendon in question, immediately after tensioning and anchoring, due to total prestressing forces and self-weight, averaged along the length of the tendon. Variations in stress arising from permanent actions applied after prestressing (generally, but not exclusively, leading to elastic shortening gains) are not incorporated into the calculation of initial elastic shortening loss.

Instantaneous losses

- ❑ **Modulus of elasticity for concrete at transfer** [$E_{cm}(t)$]. This value is used for the calculation of elastic shortening losses, according to EN1992-1-1:2004 clause 5.10.5.1(2). $E_{cm}(t)$ is defined as “the secant modulus of elasticity of concrete at time t ”. From clause 5.10.3, time $t=t_0$ (immediately after tensioning and anchoring) should be used for this calculation. Thus E_{cm} from Table 3.1 may need to be adjusted according to clause 3.1.3(3). A likely range of values would be 26-39MPa.
- ❑ **Unintentional angular displacement** [k]. This value is used in the calculation of losses due to friction, according to EN1992-1-1:2004 clause 5.10.5.2, for the component sometimes referred to as “wobble” loss and also in determining anchorage losses. k describes the “unintentional angular displacement” for internal tendons in radians per unit length. Clause 5.10.5.2(3) gives the range $0.005 < k < 0.01$ rad/m.

- ❑ **Duct friction coefficient** [μ]. This value is used in the calculation of losses due to friction according to EN1992-1-1:2004 clause 5.10.5.2(1), and also in determining anchorage losses. Suitable values may be found in Table 5.1; the default value $\mu = 0.19$ is for internal tendons made up of strand filling roughly half of the duct.

Long term losses

- ❑ **Tensile strength of prestressing steel** [f_{pk}]. This value is used for the calculation of $\Delta\sigma_{pr}$, the absolute value of relaxation losses to EN1992-1-1 clause 3.3.2(7) and incorporated into the time dependent loss calculation of clause 5.10.6(2).
- ❑ **Relaxation Class**. This is used along with f_{pk} to calculate relaxation losses. Classes 1, 2 and 3 are defined in EN1992-1-1 clause 3.3.2(4).
- ❑ **Relaxation loss at 1000 hours** [ρ_{1000}]. This is used, along with f_{pk} and the Relaxation Class, to calculate relaxation losses. Typical values may be found in clause 3.3.2(6) and the default value is based on low relaxation strand (Class 2).
- ❑ **Time after tensioning (for relaxation calcs)** [t]. This is used, along with f_{pk} , Relaxation Class and ρ_{1000} to calculate relaxation losses. According to EN1992-1-1 clause 3.3.2(8), long term (final) values of the relaxation losses may be estimated for a time (t) equal to 500 000 hours (i.e. around 57 years).
- ❑ **Shrinkage strain** [ϵ_{cs}]. This value is used in the calculation of losses due to shrinkage, according to EN1992-1-1:2004 clause 5.10.6(2). The value should be calculated from clause 3.1.4(6), depending on notional size, relative humidity, concrete strength and cement class, and should be specified “per mil” (‰) in accordance with the code (rather than actual strain).
- ❑ **Creep coefficient** [$\varphi(t,t_0)$]. This value is used in the calculation of losses due to creep, according to EN1992-1-1:2004 clause 5.10.6(2). The value should be calculated from clause 3.1.4(2), dependent upon the same parameters as the shrinkage strain plus the maturity of the concrete when the load is first applied. Values may be taken from Figure 3.1.
- ❑ **Secant modulus of elasticity for concrete** [E_{cm}]. This value is used for the calculation of time-dependent losses according to EN1992-1-1:2004 clause 5.10.6(2). The clause refers explicitly to obtaining E_{cm} from Table 3.1. A likely range of values would be 27-44MPa.
- ❑ **Change in stress due to loads after transfer** [$\Delta\sigma_{cg}$]. This is used to adjust “Concrete stress at transfer” according to the permanent loads applied after transfer, to give the concrete stress appropriate for the calculation of the creep component of time-dependent losses, according to EN1992-1-1 clause 5.10.6(2), that is, $\sigma_{c,QP} = \Delta\sigma_c(t) + \Delta\sigma_{cg}$. Note that $\Delta\sigma_{cg}$ is typically negative since applied loads oppose the prestress that dominates $\Delta\sigma_c(t)$.
- ❑ **Area of concrete section** [A_c]. **Second moment of area – concrete** [I_c]. The area and second moment of area of the concrete member to which the prestress forces will be applied. These values are used for the calculation of time-dependent losses, according to EN1992-1-1:2004 clause 5.10.6(2). Where the

concrete section varies, suitable intermediate values may be required. If the member is a standalone beam element the area of the beam should be used. If the beam member represents part of a larger structure (for example a certain width of slab) then only the area of the portion represented by this particular beam member should be used. Please note that the prestress loading facility is designed to work for a single beam member, not for a subdivided portion of slab or wide beam element, so using it in any other way is at an engineer's judgement.

Defaults

The **Defaults** button sets all previously entered values to those specified when the dialog was first displayed. Such values are illustrative only and values for use in design calculations should be checked using appropriate source data.

Notes.

- Input units are the same as the current model units unless otherwise stated on the dialog. When the prestress loads are calculated the prestress forces are converted into the current model units. The current model units can be found on the status bar of LUSAS Modeller.
- An approximate check is carried out that the specified jacking force is suitable for the tensile strength of commonly available strand, but the user should refer to EN1992-1-1 clause 5.10.3(2), manufacturer's information for the strand strengths and the appropriate National Annex for values of k_7 and k_8 in order to ensure that the tendons are not overstressed.

Defining JTG D62-2004 Tendon Properties with approximate losses, requiring input of estimated stresses

Tendon properties, including instantaneous and long term losses to be defined.

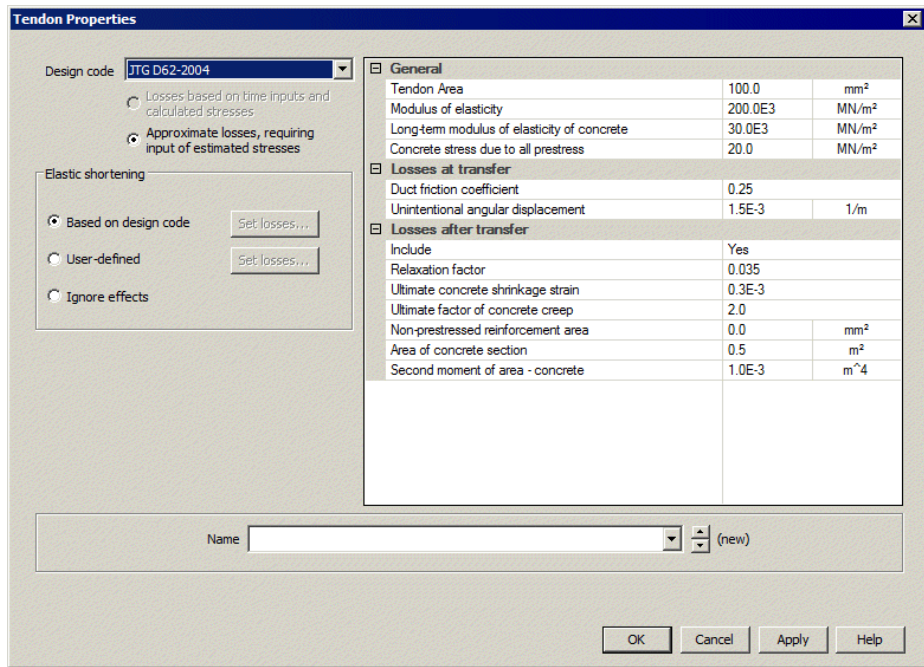

Undocumented entries

See [Defining Tendon Properties](#) for any dialog entries not covered in this topic.

General

- ❑ **Tendon area** Steel area for the tendon being defined.
- ❑ **Modulus of elasticity of tendon** Young's modulus of prestress reinforcement.
- ❑ **Long-term modulus of elasticity of concrete** The long-term Young's modulus of concrete.
- ❑ **Concrete stress due to all prestress** The stress in concrete due to prestress at the centroid of all tendons. See JTG D62-2004 section 6.1.5.

Instantaneous losses

- ❑ **Duct friction coefficient** The friction coefficient between the tendon (prestress reinforcement) and the duct (pipe). See JTG D62-2004 Table 6.2.2.
- ❑ **Unintentional angular displacement** also known as the influence factor of load deviation or wobble. This is defined per metre length. See JTG D62-2004 Table 6.2.2.

Long term losses

- Include** When set to 'Yes', prestress loss calculations are based upon approximate losses, requiring input of estimated stresses. When set to 'No', only short term losses are calculated, with elastic shortening based upon calculated losses.
- Relaxation factor** See JTG D62-2004 Section 6.2.6.
- Ultimate concrete shrinkage strain** See JTG D62-2004 Table 6.2.7.
- Ultimate factor of concrete creep** See JTG D62-2004 Table 6.2.7
- Concrete prestress due to all prestress** The stress in concrete due to prestress at the centroid of all tendons. See JTG D62-2004 section 6.1.5.
- Non-prestressed reinforcement area** The sectional area of general (non prestressed) reinforced reinforcement
- Area of concrete section** The net sectional area of concrete after the area of the pipes (ducts) and other weakened parts have been removed.
- Second moment of area- - concrete** Moment of inertia of concrete section

Defaults

The **Defaults** button sets all previously entered values to those specified when the dialog was first displayed.

Notes

- Input units are the same as the current model units unless otherwise stated on the dialog. When the prestress loads are calculated the prestress forces are converted into the current model units. The current model units can be found on the status bar of LUSAS Modeller.
- The loss due to elastic compression of concrete is computed using the simplified formula in JTG D62-2004 Appendix E.
- Guidance on the deformation of the anchorage device is provided in JTG D62-2004 Table 6.2.3.

Defining Tendon Profiles

Tendon profiles are defined using the **Utilities > Prestress > Tendon Profile** menu item. Tendon profile data can be defined manually, be copied and pasted from a spreadsheet, or be generated by selecting lines, arcs or splines that are defined or imported into LUSAS Modeller. Tendon definition by coordinates in 3D space or by defining coordinates in two 2D planes is supported.

The Tendon Profile dialog can be used to create any number of tendon profiles. Tendon profiles can be defined by:

- ❑ **Coordinate input**
- ❑ **Spreadsheet import**
- ❑ **Drawing a tendon profile**

Previously defined tendon profile data can be accessed using the drop-down list and the up/down control alongside the tendon profile name.

Tendon profile data that is defined using coordinates and radii is generally referred to in this topic as primary tendon profile data. This is because a smoothing facility may be used to define a minimum radius around or through which two intersecting tendon definition lines will be shaped, resulting in a modified profile. Note that the calculated tendon profile shape (after all smoothing has been applied) can be included in a tendon summary report in a format that is suitable for setting-out the tendon on-site.

Once defined, tendon profiles are stored in the Utilities  Treeview and are not directly assignable to geometry. They are referenced and used, along with **tendon properties**, in the definition of the **tendon loading** that is defined and then assigned to features in a model.

Defining a tendon profile by coordinate input

Defining a tendon profile in 3D space

This requires the selection of the 3D space tab and the input of X,Y and Z coordinates to define a tendon. These can be defined as global (X,Y, Z) or local (x,y,z) coordinates.



- For assignment of tendon loading to a line, global or local tendon profile definitions can be used.
- For assignment of tendon loading (which references a tendon profile) to a suitably meshed surface or volume requires the tendon profile to be defined using global coordinates.

Tendon Profile [X]

3d space | Two 2d planes

	Type	x (ft)	y (ft)	z (ft)
1	Start	0.0	0.0	0.0
2	Straight	8.51274	0.170255	0.681019
3a	Spline	9.07661	0.181532	0.720785
3b	Spline Continued	9.64068	0.192814	0.757364
3c	Spline Continued	10.2051	0.204102	0.787562
3d	Spline Continued	10.7699	0.215399	0.809249
3e	Spline Continued	11.335	0.2267	0.824549
3f	Spline Continued	11.9001	0.238002	0.836656
4a	Spline	12.1001	0.24089	0.838389
4b	Spline Continued	12.3	0.243112	0.839722
4c	Spline Continued	12.5	0.244001	0.840255
4d	Spline Continued	12.7	0.243112	0.839722
4e	Spline Continued	12.8999	0.24089	0.838389

Global coordinates
 Local coordinates mapped to lines Insert Delete

Smoothing
 Minimum radius:
 Cut corner 
 Offset line 

Name: (1 of 1)

Reverse Flip Advanced

< Back
Next >
Cancel
Help

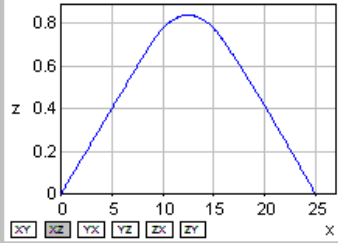
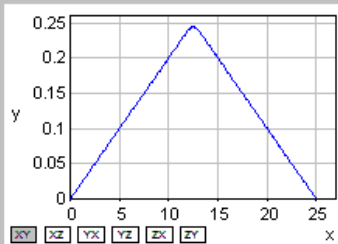
Primary tendon profile data is defined by adding rows to the grid and specifying the coordinates of each defining point along the tendon. The profile coordinates can be entered in either **Global coordinates** or **Local coordinates mapped to lines**. Local coordinates are relative to the lines the tendon profile is assigned to.

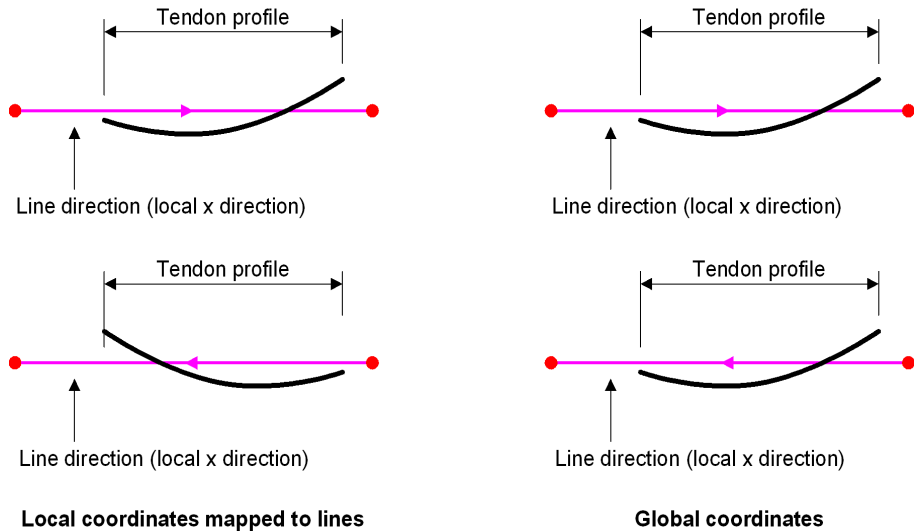

As the coordinates are entered, the tendon shape that they define is visualised in the adjacent graphs. Use the tab key to create a new row beneath the last row of entered data. Note that the use of different scales for the vertical and horizontal axes of the graphs can lead to some apparently visually impossible radii fitting at line intersections.

- Type** Clicking on the drop-list button  in this cell of the table allows the line segment type to be specified. Options are **Straight**, **Arc Bulge**, **Arc Centre**, **Arc End**, **Spline**, **Spline Continued**, **Parabola Bulge** and **Parabola End**
- The **Insert** and **Delete** buttons provide the means to create a new row above a selected row, or to delete rows.
- The **Reverse** button reverses the order of all of the rows in the table whilst maintaining the tendon shape.
- The **Flip** button mirrors the shape of the tendon profile about its mid-x coordinate.
- The **Advanced** allows editing of the number and location of tendon sampling points, at which equivalent tendon loads are calculated and applied to the model.

Defining a tendon profile in two 2D planes

Defining primary tendon profile data in two 2D planes, as opposed to the more common definition in 3D space, is a preferred method in certain countries. This requires the selection of the Two 2D planes tab and the input of x,y and radius values for both zx and xy planes. Tendon profile data can be different in each plane. Radius values need only be defined for line intersections. Projection and rotation angles can additionally be defined to cope with inclined webs and rotated beam sections.

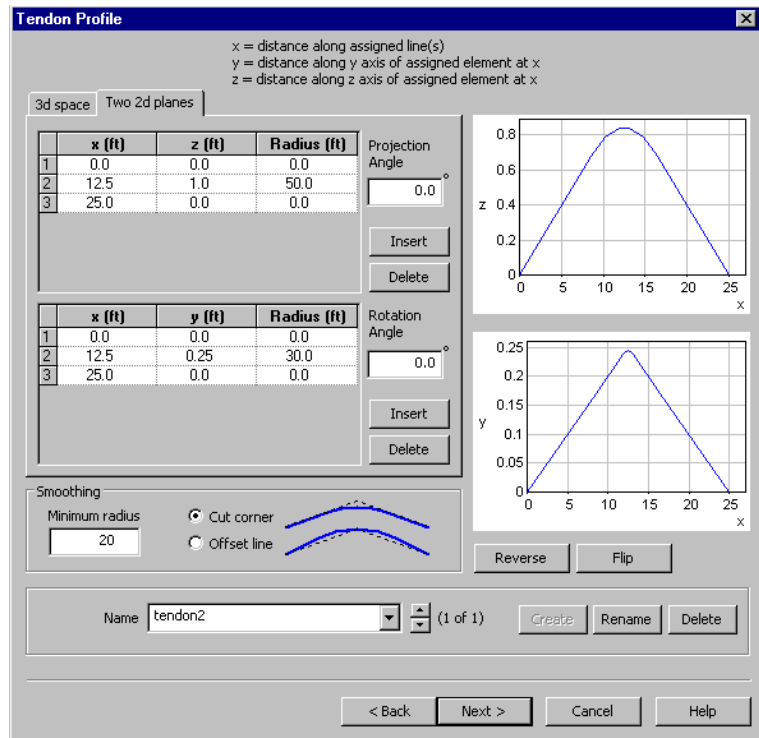

Primary tendon profile data is defined for each plane by adding rows to the grid and specifying the in-plane coordinates of each defining point along the tendon. Use the tab key to create a new row beneath the last row of entered data. As the values are entered, the tendon shape that they define is visualised in the adjacent graphs. Note that the use of different scales for the vertical and horizontal axes of the graphs can lead to some apparently visually impossible radii fitting at intersections. Use of a zero radius generates point intersections.

- The **Insert** and **Delete** buttons provide the means to create a new row above a selected row, or to delete rows. These manipulations can be carried out independently for each of the two planes.
- The **Reverse** button reverses the order of all of the rows in the table whilst maintaining the shape.
- Flip** mirrors the shape of the tendon profile about its mid-x coordinate.
- Projection angle** Use of a projection angle overcomes the difficulties in calculating z distances of an inclined elliptically shaped tendon in a 2D plane. Using a projection angle causes the z coordinates defining the shape of the tendon to be projected to the plane on which they would lie. For a vertical z axis the projection angle is that between the zx plane and the inclined plane onto which the zx curve will be projected. For a box section this would be the

angle between vertical and the inclined web (and would be zero if the web was vertical)

- ❑ **Rotation angle** This rotates a tendon definition about the beam axis to which it has been assigned. For a beam with a vertical z axis this would be the angle between the zx plane and vertical. For a box section this might represent camber of the whole section (zero if the section is level).

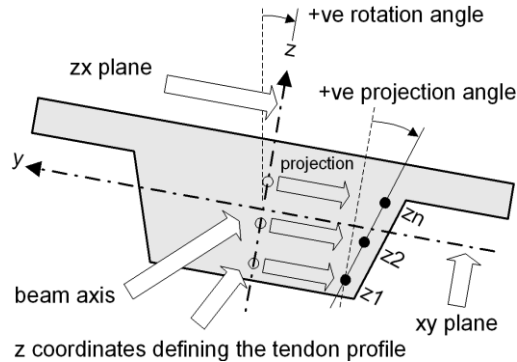

Smoothing

Smoothing allows the definition of a minimum radius around or through which two intersecting tendon definition lines will be shaped.

There are two options:

- ❑ **Cut corner** adds a radius transition between two lines inside of their defined intersection point (as per the diagram on the dialog).
- ❑ **Offset line** adds a radius transition between two lines through their defined intersection point

For primary tendon profile data defined in 3D space, if a minimum smoothing radius is defined it will be applied at all intersections along the profile. Use of a zero radius generates point intersections.

For primary tendon profile data defined in two 2D planes a minimum smoothing radius will only be applied at intersections if the radii otherwise defined for those intersections are smaller.

Defining a tendon profile by spreadsheet import

Tendon geometry and line segment information can be imported into the tendon profile grid from a spreadsheet using standard copy and paste facilities. Both four column (type and coordinate data) and three column (coordinate data only) widths are supported. When the copied data includes the line segment 'Type' the text is expected to match the drop-down list item names. Three column data is expected to be numeric and will paste into the coordinate cells wherever it is pasted.

Defining a tendon profile in LUSAS Modeller

Lines, arcs and splines that represent a tendon can, alternatively, be defined in LUSAS Modeller and then be selected prior to accessing this dialog. Line segments will be listed in the table with their setting-out information.

Notes

- If the line to which the tendon is assigned is an arc or spline, and the tendon profile is generated with a straight local x-axis, this will be “wrapped” to follow the path of the assigned curve, and therefore there is no need to curve the tendon profile. In this situation it may be better to specify the profile as a curve in global coordinates.
- It is not possible to convert 3D space data tendon profile definition into a 'Two 2D plane' tendon profile definition.
- For tendon profiles defined in two 2D planes there is no requirement for the number of inputs to be the same for the XY and YZ planes or for the X coordinates to be coincident, although the first and last sets of values in both grids must span the same X range.
- Tendon profiles defined in two 2D planes can be viewed in 3D tendon coordinate format (by pressing the 3D Space tab). Changes can be made to 3D Space data viewed in this way but if made, the two 2D planes definition will be lost.

Converting a tendon profile into line geometry

For some applications such as importing a [Tendon Prestress Definition from a Spreadsheet](#) it may be required to convert tendon profile data into line, arc, spline or combined line geometry so that the tendon can be selected. Use the **Create geometry** context menu item for a tendon profile in the Utilities  Treeview to do this.

Defining a Tendon Profile - Advanced options

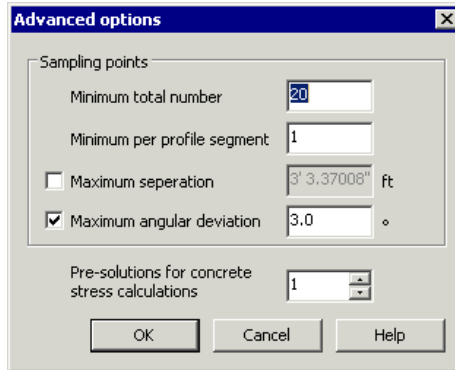

Sampling points

For each line segment (that is for each line, arc or spline) of each tendon profile, the number and location of tendon sampling points are calculated according to values specified on the Sampling Points dialog. Tendon sampling points are the locations along a tendon profile at which equivalent tendon loads are calculated and applied to the model. The calculation of the equivalent tendon loads is based upon an underlying piecewise linear curve that is defined by the sampling point settings made. Note that the original points used to define the line, arc or spline have no bearing on any calculations that are carried out. They are simply used to ensure a good tendon profile is obtained.

- Minimum total number** specifies the minimum number of sampling points that will be accepted throughout the tendon profile.
- Minimum per profile segment** specifies the minimum number of sampling points that will be accepted per line segment of the tendon profile.
- Maximum deviation** specifies the maximum offset distance (in modelling units) from the line segment of the tendon profile to the adjacent line of the generated piecewise linear curve that will be accepted along each line segment of tendon profile.
- Maximum angular deviation** specifies the maximum angle of deviation between segments that will be accepted.

From the Minimum total number, Minimum per profile segment and Maximum deviation value entries specified a calculated number of sampling points for each line segment will be arrived at. The Maximum angular deviation value will introduce additional sampling points in line segments where the line segment curvature is high.

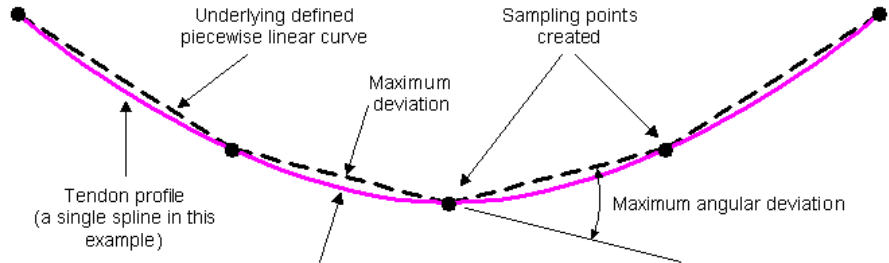

Note that the maximum deviation distance is input and displayed in current model units. Consistently with other inputs in Modeller, changing the units after entering a value changes the meaning, not the numerical value that was previously input.

Other options

- **Pre-solutions for concrete stress calculations** - The number of times the model should be solved to calculate prestress effects. For the first solve (the pre-solution), the stress at transfer is assumed to be zero, all time-dependent losses are assumed to be zero, and the prestress loads calculated accordingly. In the second (or subsequent) solve, the stress at transfer is calculated using the eccentricity of each sampling point, and the forces that are read from the results of the corresponding loadcase in the first (or previous) solution. The default number of pre-solutions is 1.

Defining Tendon Loading

Tendon loading is defined by using the **Attributes > Loading** menu item and selecting the **Tendon** option. The **tendon profile** and **tendon property** drop-down lists are populated with pre-defined tendon profile and tendon properties present in the Utilities  Treeview. New tendon profiles and tendon properties can also be created from this dialog by selecting the **New** drop-down option from these lists.

Using the dialog, tendon profiles and tendon properties are associated with a specified prestress force and associated jacking and loss details. Anchorage losses are defined as slippage from either, or both ends. An approximate check that the specified jacking force is suitable for the tensile strength of commonly available strand is carried out but reference should be made to the relevant design code and manufacturer's information for the strand strengths and any applicable factors in order to ensure that the tendons are not overstressed.

Once defined, a tendon loading attribute is added to the Attributes  Treeview. This can be directly assigned to selected features in a model.

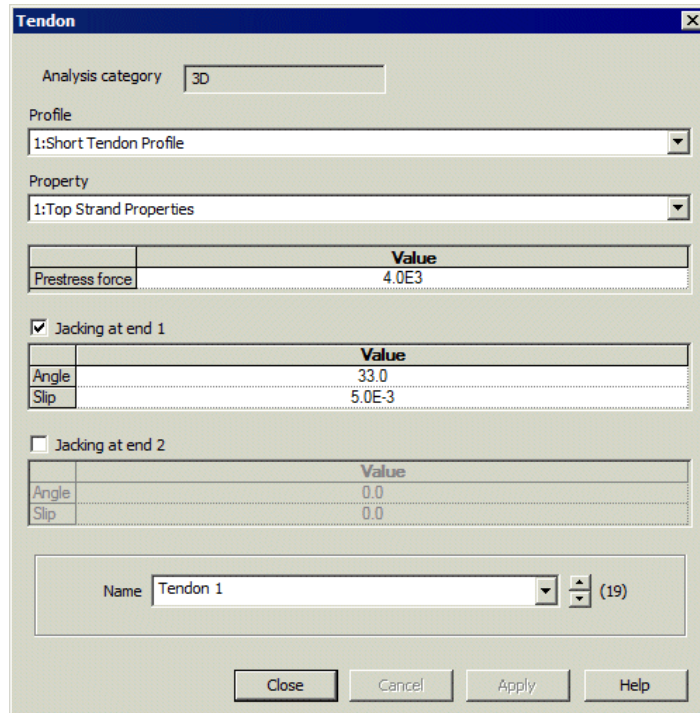

Tendon Loading Assignment

The tendon loading assignment dialog appears when a **tendon loading** attribute (that references **tendon property** and **tendon profile** information) is assigned to a line, surface or volume feature. It provides the means to specify how tendon loading is to be applied and, for assignment to lines, the mapping and offset options that can be used, as well as specifying in which loadcase(s) the tendon loading should apply.

Note that an assigned tendon load (and associated tendon profile) can only be visualised if any features to which the tendon load is assigned are meshed.

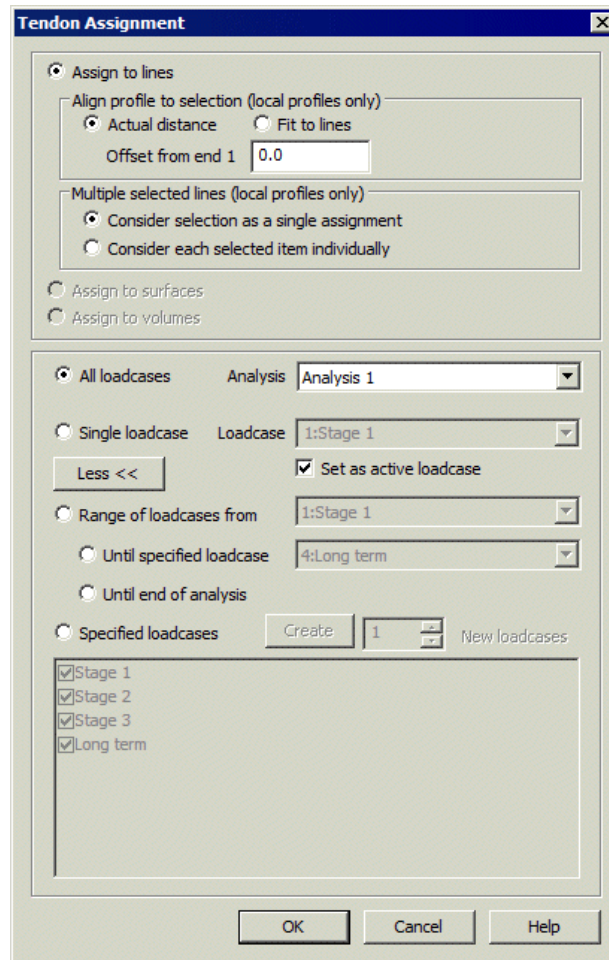

Assign tendon loads to lines

For tendon profiles defined as 'Local coordinates mapped to lines' on the Tendon Profile dialog, these options provide the means to align the tendon profile to the line(s) selected, or fit a tendon profile to the line(s) selected, as well as offset the start of the tendon from the starting end of the selected line(s).

- Actual distance** is used by default. The actual tendon profile length is used.
- Fit to Lines** is used if a tendon profile needs to be contracted or expanded to match the length of a line or series of lines. This only maps the tendon profile data to the line(s) selected and does not change the actual tendon profile definition. Note that the mapping does not provide a uniform scaling so arcs in the profile will become ellipses, and the y and z maxima and minima will not change.

- ❑ **Offset from End 1** allows the selected tendon profile to be displaced with reference to the starting point of the line or lines stated.

Notes

- Checks are made on saving the assignment that the lines selected for assignment form a single continuous open-ended path. Unconnected lines, multiple paths, branching and /or a closed loop are reported as an error.
- Line numbering and line direction determines the tendon profile direction for the superimposed tendon. Line direction must be consistent along the selected lines representing the beam assignments. Any inconsistencies in line direction will cause an error.

Multiple selected lines (local profiles only)

For tendon profiles defined as 'Local coordinates mapped to lines' on the Tendon Profile dialog, and for multiple selected lines:

- ❑ **Consider selection as a single assignment** The tendon profile defined will start and end at the start and end of the set of lines selected.
- ❑ **Consider each selected item individually** The tendon profile will start at the start of each selected line.

Examples of tendon loading assignments

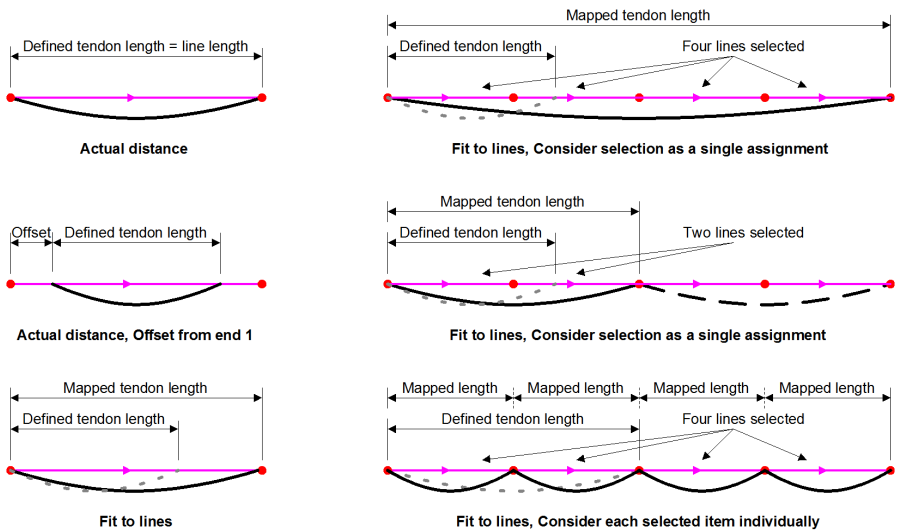

Assign tendon loads to surfaces and volumes

Assignment of tendon loads to a surface or a volume requires a tendon profile to be defined using 'Global coordinates' on the Tendon Profile dialog. The defined tendon

length is used and the tendon is positioned in the model at the start coordinate specified within the tendon profile dataset. Tendon loads can be assigned to plane stress, plane strain and shell elements.

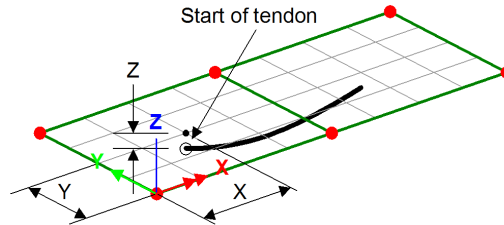

Assign tendon loads to loadcases

Tendon loads can be assigned to all loadcases within a chosen Analysis, or a single loadcase, or to a range of loadcases.

- All loadcases** assigns the loading to all loadcases in the chosen analysis (selected from the Analysis drop-down list), or to a new analysis, defined after selecting the **New...** option in the Analysis drop-down list
- Single loadcase** assigns loading to a single loadcase in the specified analysis, or to a new loadcase, defined after selecting the **New...** option in the Loadcase drop-down list. Note that the loadcase identifier at the start of the loadcase name generated is for internal use only and cannot be user-defined.
- Set as active loadcase** When a single loadcase is selected, setting that loadcase as the active loadcase ensures that immediate load visualisation will take place.

Advanced loadcase selection

Pressing the **More >>** button on the Loading Assignment dialog provides additional options to assign loading to a range of loadcases, or to one or more specified loadcases within an analysis.

- Range of loadcases from** specifies the starting loadcase in the Analyses Treeview of a range of loadcases to which the loading will be assigned. One of the next two settings will also be required.
- Until specified loadcase** Specifies the end of the loadcase range in the Analyses Treeview to which the loading will be assigned.
- Until end of analysis** Assigns the loading to all loadcases that follow the specified starting loadcase in the Analyses Treeview.
- Specified loadcases** permits individual selection of one or more loadcases to which the loading will be assigned.

After assignment

After assigning all tendon load attributes the model can be solved. See [Running an Analysis](#).

Tendon Prestress Loading Definition from a Spreadsheet

As an alternative to defining a tendon profile, defining tendon properties and have LUSAS Modeller calculate the tendon loading for a tendon, if tendon forces have been computed directly by an engineer they can be imported via a spreadsheet. To do so, the lines defining a tendon need to be drawn and selected prior to choosing the **Bridge > Prestress > Spreadsheet Import** menu option. When done, a spreadsheet is created that is populated with tendon profile data from the selected tendon, allowing tendon forces to be stated for each point defining the tendon.

Usage

Prior to using this facility the line, arc, spline or combined line defining the tendon must be selected and then, but only if carrying out a 'Beam' analysis, the **Shift** key must be used to additionally select the beam(s) to which the tendon applies, prior to selecting the **Bridge > Prestress > Spreadsheet Import** menu option.

The screenshot shows a dialog box titled "Prestress Definition from Spreadsheet". It contains the following elements:

- Analysis type:** A dropdown menu currently set to "Beam".
- Tendon sampling points:** A text input field containing the number "10".
- Spreadsheet:** A text input field containing the file path "C:\Prestress Tendon 0.xls", accompanied by a "Browse..." button.
- Anchorage:** A dropdown menu currently set to "End 1 Only".
- End 1 jack angle (deg):** A text input field containing "0".
- End 2 jack angle (deg):** A text input field containing "0".
- Buttons:** "OK", "Cancel", and "Help" buttons are located at the bottom of the dialog.

Tendon details

- **Tendon sampling points** are the number of locations along a spline at which calculated equivalent tendon loads will be applied to the model. Note that the original points used to define the spline have no bearing on any calculations that are carried out, they are simply used to ensure a good tendon profile is obtained.

Spreadsheet

A filename for the spreadsheet is automatically entered for creation in the current working directory. When the **OK** button is clicked the previously selected tendon geometry is written to the spreadsheet along with angle and cable length data. The

spreadsheet is then automatically opened to allow tendon forces to be manually added. Note that it may be necessary to bring the spreadsheet application in front of the Modeller application in order to view it.

An example spreadsheet is shown below.

Notes:

- (a) The **number of points** cell (B22) contains the number of points used to define the tendon in Modeller and **must not be changed**.
- (b) The **start row** cell (D22) contains the row number at which the tendon forces begin, **default = row 26**.
- (c) The **force column** cell (F22) contains the column number in which the tendon forces are defined, **default = column 6**.
- (d) Cells D22 and F22 are the only cells in row 22 which should be modified.
- (e) The **X,Y,Z** columns contain the coordinates of the points defining the tendon profile.
- (f) The **angle** column contains the incremental change in tendon angle (in radians) at each point.
- (g) The **cable length** column contains the length of cable at each pt. measured from end 1.
- (h) **Do NOT exit Excel, when finished click on one of the buttons below.**
- (i) If there is no response when one of the buttons below is clicked, return to the Modeller window and click on the "retry" button in the server busy message box.

No. points	11	Start row	26	Force column	6
X	Y	Z	Angle	Cable length	Force
-6	-0.5	1.225	0	0	
-4.802878	-0.60794	1.225	0.019983	0	
-3.603837	-0.69194	1.225	0.019983	0	
-2.403358	-0.75197	1.225	0.019983	0	
-1.201919	-0.78799	1.225	0.019983	0	
0	-0.8	1.225	0.019983	0	
1.201919	-0.78799	1.225	0.019983	0	
2.4033581	-0.75197	1.225	0.019983	0	
3.6038374	-0.69194	1.225	0.019983	0	
4.8028776	-0.60794	1.225	0.019983	0	
6	-0.5	1.225	0	0	

Detailed notes are included on the spreadsheet.

Enter appropriate values into the Force column, and when complete press the 'Click here when tendon forces have been added' button.

- Click here when tendon forces have been added** - when this button is pressed tendon loading datasets are created in the Attributes Treeview and assigned to

the relevant lines within Modeller, and tendon graphing datasets of distance and short-term losses are created in the Utilities  Treeview.

- Cancel** cancels all input.

Jacking details

On the Prestress Definition from Spreadsheet dialog jacking end and jacking angle details can be defined for End 1 only, End 2 only, or for Both Ends of the tendon. End 1 is the start of the spline used to define the tendon.

Notes

- If tendon realignment is required the previously assigned tendon loading properties should be removed from the model and the Prestress Definition from Spreadsheet option re-run to calculate the new geometric properties for the new tendon alignment.

Rail Track- Structure Interaction Analysis

Overview

The LUSAS Rail Track Analysis software option permits track/bridge interaction analysis to the International Union of Railways Code UIC774-3. Dialogs that enable model building, definition of loading and post-processing of results are accessed from the **Bridge** (or **Civil**) > **Rail Track Analysis UIC774-3** menu item.

Track and bridge interaction models are built automatically in LUSAS from geometric, material property, and loading data defined in a MS Excel spreadsheet. Both thermal loading to the track and train loading due to acceleration and braking forces can be defined. In accordance with the UIC774-3 code of practice, a user-specified element length is used to define the longitudinal embankment and bridge features. Rail clips, ballast movement, bearings and pier stiffness are all included in the analysis model. The model building dialogs allow for either one train crossing one or more structures, or for multiple trains crossing the same structure

When running an analysis, deck temperature loading can be considered in isolation for subsequent analysis of multiple rail configurations, or a full analysis can be carried out considering the combined temperature in the deck and rail loading. Because the response of the ballast and/or clips is nonlinear a nonlinear analysis always needs to be carried out.

Results can be produced in either Excel spreadsheet or standard LUSAS results file format. User-defined load combinations can be specified. Spreadsheet results include

deformations, forces/moments and axial stresses in the rails of the tracks and deformations and forces / moments in the deck structure.

The use of individual dialogs is explained in the following topics. For more detailed information refer to the *Rail Track Analysis Manual*.

Worked Example

- See Online help > Worked Examples > For Rail Track Analysis Option> ‘Track-Structure Interaction to UIC774-3’, which shows the use of this facility. This example examines the track-structure interaction between a braking train and a single span bridge to replicate (as far as the original test data allows) testcase E1-3 which can be found in Appendix D.1 of the UIC774-3 Code of Practice.

UIC774-3 Model Builder

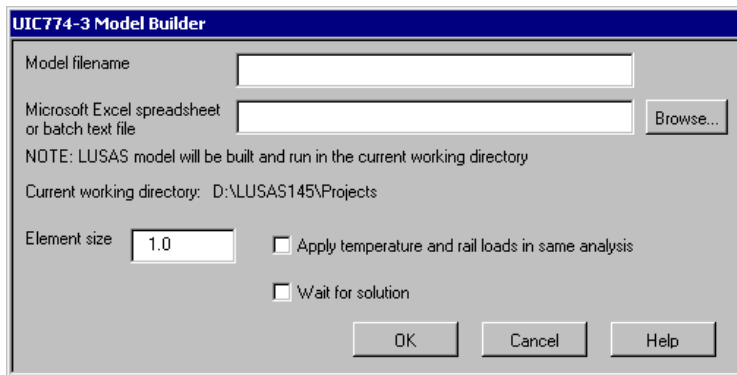

To use the UIC774-3 analysis option a spreadsheet describing the model geometry, properties and loading should have been defined. To do this use the template located in the <Lusas Installation Folder>\Programs\Scripts\User directory and enter the required information into the appropriate locations. All units for the analysis are metric and are listed for the sections within this spreadsheet.

Note: Each ‘rail’ in the Geometric Properties definition represents a single track on the structure and therefore should have geometric properties equal to double that of a single rail. Up to two tracks can be present on the structure.

Analysing a Single Structure

If a single analysis is being carried out then a model filename should be specified with or without the *.mdl extension. A directory should not be specified with this model filename as the current working directory is used for saving the model.

The Microsoft Excel filename should be entered or located using the **Browse...** button

Batch Processing Multiple Structures

If multiple models are to be built and analysed the batch processing facilities can be used. For this a batch text file (with a *.txt extension) should be created that contains the name of one valid Excel spreadsheet per line that defines the models. If the spreadsheet exists and contains valid data then the model will be built and solved in the same directory as the Excel spreadsheet. The number of Excel spreadsheets is unlimited.

The batch text filename should be entered into the dialog or located using the Browse... button and choosing Batch text file (*.txt) as the file type. No model filename should be entered as this will be defined by the basename of the Excel spreadsheet in the batch text file.

Common Input for Single or Multiple Structures

The element size to use in the Finite Element mesh should be specified in this box. According to the UIC774-3 Code of Practice, the maximum element size that is permitted in an analysis is 2.0m (Clause 1.7.3). The dialog therefore generally allows element sizes of $0 < \text{Element Size} \leq 2.0\text{m}$ for the building of the models. Larger element sizes can be used (up to the length of the smallest bridge deck span) but a warning will be issued about non-compliance with the UIC774-3 Code of Practice. Note that for large bridges and/or embankments the use of small element sizes can generate excessively large models which take significant time to manipulate / solve. Use of element sizes below 1.0m should be used with caution.

By default, only the temperature loading is applied to the decks of the structure which allows multiple train load configurations to be applied to the same structure. If, however, the combined deck temperature and rail loading is to be solved in a single analysis then the Apply temperature and rail loads in same analysis option should be selected.

If the option to wait for the solution is selected then all of the analyses will be run from Modeller and nothing can be carried out in the current Modeller window until the solution has finished. For relatively small structures or analyses with a limited set of parametric trainset loading locations this may be fine. If a large number of parametric trainset loading locations are included in an analysis and/or a large number of models are being built using the batch processing then waiting for the solution can take a considerable amount of time.

On clicking the OK button the model(s) will be built and solved automatically by the software. A log file called UIC774-3_BuildModel.log will be created in the current working directory if batch processing is used to report any errors encountered during the batch process.

UIC774-3 Rail Loads

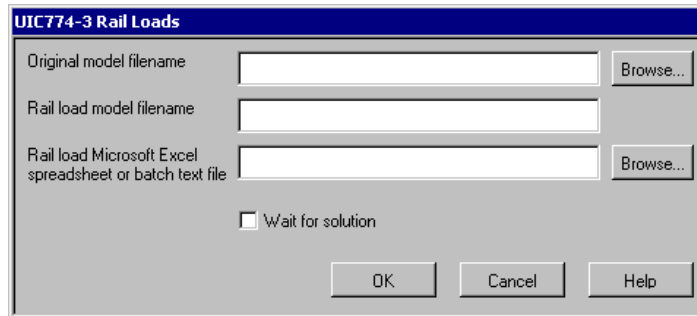

If only the temperature effects have been applied to the model using the UIC774-3 Model Builder dialog then single or multiple rail configurations can be applied using this dialog.

Note: Attempting to use this dialog on a model that has not been created using the model builder dialog or that has loading other than temperature loads will generate an error message.

Applying train loads to the current model

If the current model loaded was generated from the Build Model... dialog with the Apply temperature and rail loads in same analysis option turned off then this option can be selected. If this option is not selected then the Original model filename entry is available for manual selection of the original model containing only temperature loads.

Analysing a Single Structure with One Rail Load Configuration

If a single rail load configuration is to be analysed for a single structure either enter the filename of the existing LUSAS temperature model created using the model builder or select it using the **Browse...** button. Enter the filename for the new model (omitting any path description as the model will be saved in the current working directory). This filename can be the same as the original model but it is recommended that an alternative filename is used so the original model remains unchanged. Finally enter the filename for the Excel spreadsheet that contains the rail load configuration description or select it using the **Browse...** button.

Analysing a Single Structure or Multiple Structures with Multiple Rail Load Configurations

If multiple models and / or multiple rail load configurations are to be analysed then only the batch text file should be entered or selected using the **Browse...** button and choosing Batch text file (*.txt) as the file type. The batch text file should be TAB

delimited and contain the filename of the original model file, the filename of the new model to be created and the filename of the Excel spreadsheet containing the rail loading, e.g.

Viaduct 1.mdl Viaduct 1_RailConfig1.mdl Viaduct 1_RailConfig1.xls

Viaduct 1.mdl Viaduct 1_RailConfig2.mdl Viaduct 1_RailConfig2.xls

Viaduct 1.mdl Viaduct 1_RailConfig3.mdl Viaduct 1_RailConfig3.xls

Viaduct 2.mdl Viaduct 2_RailConfig1.mdl Viaduct 2_RailConfig1.xls

Viaduct 2.mdl Viaduct 2_RailConfig2.mdl Viaduct 2_RailConfig2.xls

In the above example, two different viaduct temperature models have been selected and three rail load configurations chosen for the first and two for the second models. The number of entries in the batch text file is unlimited.

Common Input for Single or Multiple Structures / Rail Loads

If the option to wait for the solution is selected then all of the analyses will be run from Modeller and nothing can be carried out in the current Modeller window until the solution has finished. For relatively small structures or analyses with a limited set of parametric trainset loading locations this may be fine. If a large number of parametric trainset loading locations are included in an analysis and/or a large number of models are being built using the batch processing then waiting for the solution can take a considerable amount of time.

On clicking the **OK** button the combined temperature and rail load model(s) will be built from the original temperature model(s) and solved automatically by the software. A log file called UIC774-3_RailLoads.log will be created in the current working directory and will report any errors encountered during the batch process.

UIC774-3 Post-Processor

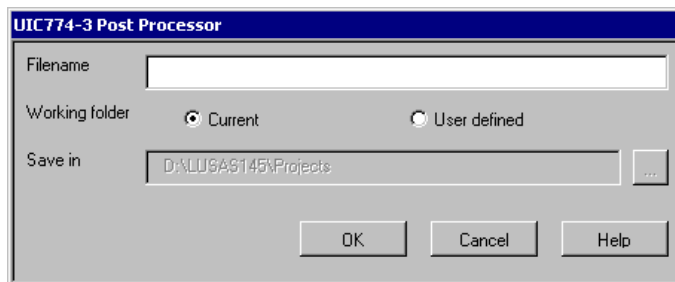

The models created by the UIC774-3 model building software can be post-processed in Microsoft Excel with the post-processing dialog. This allows the extraction of the

results along with automatic generation of graphs and enveloping in Microsoft Excel. In addition, if enveloping is performed in Microsoft Excel then additional summary tables are generated for key quantities that need to be checked for compliance with UIC774-3 under clause 1.7.2 of the Code of Practice.

On startup of the dialog, if valid UIC774-3 model groups are found, namely "Track 1", "Track 2" and "Decks" then the results can be extracted using these groups or for individual selected rail nodes. If, however, these groups are not found then the current selection will be used if it contains lines with thick 3D engineering beams assigned. If no valid groups or selection are found then the post-processor will report an error.

To use the post-processor, enter the filename for the Excel file that will be created. The directory in which to place the Microsoft Excel file can be selected but is, by default, the current working directory.

On clicking OK the post-processor will extract the results from all of the results loadcases. If envelopes or basic combinations are defined in the model then the option to process envelopes and generate the additional summary tables will not be available and all envelopes (without association) and basic combinations defined in the model file will be extracted. If the groups are being processed and no envelopes or basic combinations are defined in the model then the option to process the envelopes in Microsoft Excel will become available. If multiple results files are loaded, for example if multiple rail load configurations have been analysed and the results loaded into Modeller, then the results for all of these results files will be extracted into the Microsoft Excel spreadsheet.

On opening the spreadsheet, if the model originally contained the UIC774-3 groups ("Track 1", "Track 2" and "Decks") then the results for each item will be placed into a separate worksheet within the spreadsheet. If the selection was used for post-processing a single worksheet will be placed into the Microsoft Excel spreadsheet. Additional worksheets will also be generated if enveloping is carried out in Microsoft Excel. If individual rail nodes were selected and post-processed, the spreadsheet will contain a separate worksheet for each node that lists the rail stresses seen at the location of the node for all results processed.

Crack Width Calculation to EN 1992-1-1

Overview

The Crack Width calculation facility is accessed using the **Bridge / Civil> Crack Widths to EN 1992-1-1** menu item. This is provided in selected Bridge and Civil & Structural software products only. It enables plotting of contours of design crack widths in accordance with the EN 1992-1-1 design code. The calculations carried out are for reinforced concrete structures that are modelled using the Smoothed Multi Crack Concrete Model, that have steel reinforcement modelled with reinforcement attributes, using a linear steel material model.

See [Crack Width Calculation Methods Available](#) for other crack width calculation options.

Using the Crack Width Calculator

Prior to obtaining results from the Crack Width Calculator, a 2D or 3D model containing lines assigned with bar [reinforcement attributes](#) and meshed with bar elements must have been created, loaded and solved. Loadcases considered and load combinations created should include those appropriate to the calculations to be carried out.

Running the Crack Width Calculator provides access to the Crack Width parameters dialog.

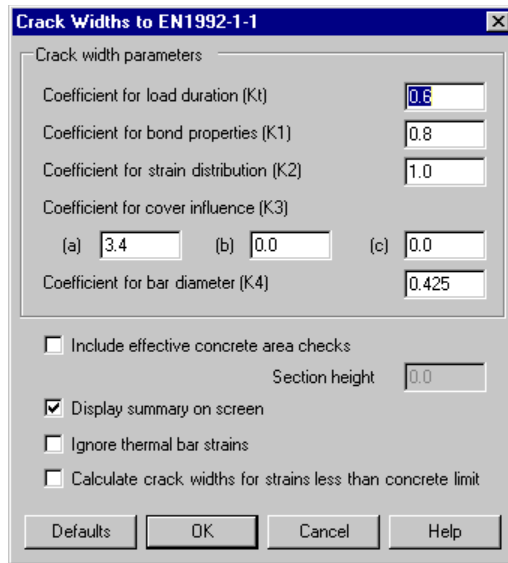

Crack Width Control dialog for EN 1992-1-1

Crack width parameters : Coefficients to be stated

- ❑ **Coefficient for load duration (kt)** a factor dependent on the load duration, (EN 1991-1-1:2004 equation 7.9)
- ❑ **Coefficient for bond properties (k1)** takes account of the bond properties of the bonded reinforcement, (EN 1991-1-1:2004 equation 7.11)
- ❑ **Coefficient for strain distribution (k2)** takes account of the distribution of strain, (EN 1991-1-1:2004 equation 7.11)
- ❑ **Coefficient for cover influence (k3)** Coefficient controlling the influence of cover on crack spacing. (EN 1991-1-1:2004 equation 7.11). In clause 7.3.4(3), k_3 is an NDP. It requires special treatment for some nations and is taken to be of the form:

$$k_3 = k_{3A} \cdot \phi^{k_{3B}} \cdot c_{cr}^{k_{3C}}$$

where generally $k_{3B} \geq 0$ and $k_{3C} \leq 0$. For most nations, $k_{3A} = 3.4$, $k_{3B} = 0$ and $k_{3C} = 0$, but defaults are set as appropriate to the National Annex. This equation accommodates the requirements of the two national annexes that account for cover and bar diameter.

- ❑ **Coefficient for bar diameter (k4)** controls the influence of bar diameter on crack spacing, (EN 1991-1-1:2004 equation 7.11)

Note that the distribution of strain is considered to be accounted for in the nonlinear concrete model and therefore it is recommended that $k_2 = 1.0$

Additional options

- Include effective concrete area checks** The effective depth of concrete is limited by EN 1991-1-1 to less than or equal to half the beam depth or to one third of the depth minus the neutral axis. Due to the nature of the analysis the location of the neutral axis is unknown and therefore this check cannot be carried out. The option to limit the effective concrete height to half the section height is provided and for this the section height must be entered manually. The default approach to neglect the check is considered conservative.
- Display summary on screen** The option to display a summary of crack width information is provided.
- Ignore thermal bar strains** In coupled (Structural and Thermal) analyses steel strains include both temperature and mechanical strains. In calculating the crack widths it is generally only the mechanical strains that are of interest. The option to ignore thermal strains should therefore be used in coupled analyses when crack widths are to be calculated based on the mechanical steel strains only.
- Calculate crack widths for strains less than the concrete limit** It is assumed that cracking only occurs when the tensile strain limit of the concrete is exceeded. This assumption can be overridden and theoretical crack widths calculated for concrete strains less than the theoretical cracking strain by selecting this option

Results displayed

Crack width contours are plotted along the bar elements (actually on the surface of the fleshed bar section) corresponding to the steel strains used in the calculation, and not on any concrete face or surface in the model. They are plotted for an active loadcase (or combination) and are re-computed if a different loadcase is set active. This visualisation method is used because the approach to calculating crack widths in EN 1991-1-1:2009 is generally unclear as to where the crack width calculation applies.

Crack width information can be plotted for the Contour and Values layers as components of Maximum Crack Width under the Crack Widths EN1991-1 entity. These settings are automatically made when the Crack Width calculation facility is used.

A Crack Widths Control dialog provides an easy means of returning to and changing the crack width calculation parameters used.

A typical crack width contour plot for a 2D plane strain model is shown below.

Analysis: Analysis 1

Loadcase: 6:Loadcase 1, Increment 6 Load Factor = 15000.0

Results file: nl_beam_102_with_16mm_bar_attributes_linear_steel-Analysis 1.mys

Entity: Crack widths EN1992-1-1

Component: Maximum Crack Width (Units: mm)

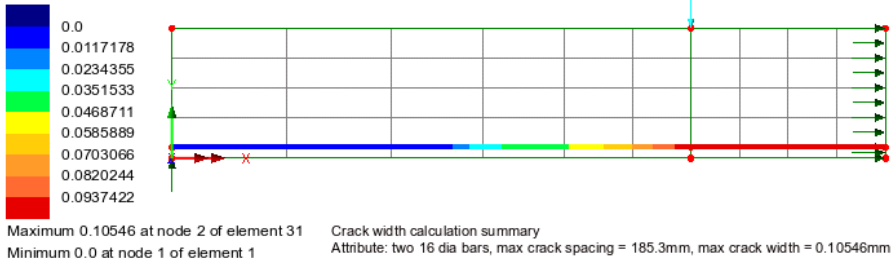

Notes

- All calculations are based upon EN1992-1-1 clause 7.3.4.
- Crack width calculation to EN1991-1-1 can only be carried out using this utility when a nonlinear concrete material, that has a concrete tensile strength, such as Smoothed Multi Crack Concrete Model, is used, bar reinforcement is modelled with **reinforcement attributes**, and a linear steel material model is used to represent the steel reinforcement. This is because of the steel strains used in the calculations.
- Crack width calculation relies on attributes being assigned to geometry and available during calculation so the menu item is disabled and not available when only a results file is loaded.
- If reinforcement attribute values are changed the model must be re-solved prior to running the Crack Width calculation facility.

Construction Tables

Overview

The construction table facility can be used to produce Camber, Displacement History, and Incremental Displacement tables of results for selected locations (points) on the model, and for any specified results loadcases. It is available for selected LUSAS Bridge and LUSAS Civil & Structural software products only. It is accessed from the **Bridge>** or **Civil> Construction Table...** menu item.

Prior to selecting the Construction Table menu item, points of interest need to be selected on the model. The construction table facility calculates values for the nodes associated with those selected points, in the order that the points were selected. If the specified loadcases include time dependent effects (e.g. creep), the time at which the values are measured will also be included.

Selecting an analysis

- Analysis** The analysis containing the loadcases defining the construction stages must be selected. It is not possible to include loadcases from more than one analysis in the construction table.

Table types supported

- Camber table to target stage** Camber tables are the reverse of Displacement History tables (see below), and are used to set-out a structure towards a target (as-built) profile while accounting for effects during construction, such as dead-load deflection, creep and concrete shrinkage. They can also be used to ensure the deflection of a structure under live-load does not encroach inside a clearance zone (typically referred to as pre-camber). A target (zero deformation) construction stage (loadcase) within the selected analysis must be specified from the drop-down list of those available for the chosen analysis. Where loadcases include nonlinear time-steps it is assumed that the final time-step is representative of the loadcase defining that construction stage as a whole. The values of the Camber table are absolute with reference to an undeformed geometry 'datum'.

- ❑ **Displacement history** A Displacement History table reports the absolute displacement of a series of key-points at each stage with reference to an undeformed geometry 'datum'. This information may be used, for example, when constructing reinforced earthwork ramps, to determine the settlement at each rise and the required flexibility of transition slabs, or the total displacement of specified points throughout the construction of a bridge after each stage.
- ❑ **Incremental displacements** An Incremental Displacement history table reports the stage-by-stage deformation of a structure. It tabulates the relative displacements between each construction stage, which can then be used in setting-out of structures built using sequential construction methods.

See [Construction Tables Explained](#) for more details.

Filter options

- ❑ **Whole analysis** reports on deformations for all loadcases in a selected analysis.
- ❑ **Specified loadcases** provides the means to specify a subset of sequential, non-repeating loadcases with results from the current analysis to include as stages within the table. Where loadcases include nonlinear time-steps it is assumed that the final time-step is representative of the loadcase defining that construction stage as a whole.
- ❑ **Only report vertical axis** reports only on deformations in the **vertical axis** direction for the selected point (and hence node) locations (if checked), or reports on deformations in all three axes (if unchecked).

Notes and limitations

- Loadcase stages selected for inclusion within a construction table must be sequential and cannot repeat.
- The camber table is effectively the inverse of the displacement history. In a simple example, the target geometry of a bridge is cambered upward, so that the final as-built shape is notionally flat: the upward camber is the inverse of a calculated sag from the analysis. However, the approach has limitations and care should be taken when using the Camber Table for structures with nonlinearity. For example, if a beam buckled to the left during the analysis, the Camber Table would suggest a target geometry with that beam heavily cambered to the right. This would not be an appropriate use of the Camber Table function. Similarly, lift-off during construction needs to be considered carefully, since it may present construction risks, and a Camber Table based on an analysis with lift-off would probably not give appropriate target geometries. However, in structures with taut cables or with certain material nonlinearities, for example, the use of the camber table may be acceptable, understanding that it will be an approximation.

Construction Tables Explained

Three different construction tables can be created: Camber, Displacement History, and Incremental Displacement.

Camber table

Camber tables are used to set-out a structure towards a target (as-built) profile while accounting for effects during construction, such as dead-load deflection, creep and concrete shrinkage. Displacement values in a Camber table are absolute values with reference to an undeformed geometry 'datum'. They are effectively the reverse of Displacement History tables (see below).

By definition a Camber table means that the currently undeformed mesh (the model geometry) must be displaced to achieve the same geometry at a later stage. As a result an undeformed mesh 'Datum' is always added to the table. For the Camber table shown below, the target stage was defined as Stage 3. For this, the table was calculated to achieve the undeformed mesh geometry on the 180th day (end of Stage 3).

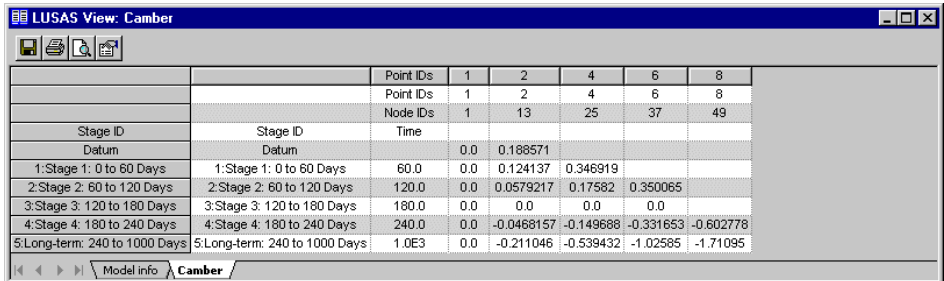

		Point IDs	1	2	4	6	8
		Point IDs	1	2	4	6	8
		Node IDs	1	13	25	37	49
Stage ID	Stage ID	Time					
Datum	Datum	0.0	0.188571				
1:Stage 1: 0 to 60 Days	1:Stage 1: 0 to 60 Days	60.0	0.0	0.124137	0.346919		
2:Stage 2: 60 to 120 Days	2:Stage 2: 60 to 120 Days	120.0	0.0	0.0579217	0.17582	0.350065	
3:Stage 3: 120 to 180 Days	3:Stage 3: 120 to 180 Days	180.0	0.0	0.0	0.0	0.0	
4:Stage 4: 180 to 240 Days	4:Stage 4: 180 to 240 Days	240.0	0.0	-0.0468157	-0.149688	-0.331653	-0.602778
5:Long-term: 240 to 1000 Days	5:Long-term: 240 to 1000 Days	1.0E3	0.0	-0.211046	-0.539432	-1.02585	-1.71095

Notes

- Row 4 of the table (the Datum row) specifies the geometry at the start of Stage 1 (0 days)
- Row 5 and 6 specify the target geometry at the start of Stage 2 and Stage 3 respectively
- Rows 7, 8 and 9 specify the resulting geometry at the end of Stage 3, Stage 4 and Long-term respectively.
- Displacements are shown if a node is active in the following stage prior to the target, and the current stage for both the target and those after.

Displacement History table

A Displacement History table reports the absolute displacement of a series of key-points at each stage with reference to an undeformed geometry 'datum'. This

information could be used, for example, when constructing reinforced earthwork ramps, to determine the settlement at each rise and the required flexibility of transition slabs, or the total displacement of specified points throughout the construction of a bridge after each construction stage.

The Displacement History table below shows displacement values in all three axes on a model with time-steps. Where a node associated with a point is deactivated during a loadcase no displacement is reported and the respective cell is left blank. If only particular loadcases were specified for inclusion (as opposed to listing results for the whole analysis) the results for each excluded stage will be omitted.

		Point IDs	1	1	1	2	2	2	4	4	4	6
		Point IDs	1	1	1	2	2	2	4	4	4	6
		Node IDs	1	1	1	13	13	13	25	25	25	37
Stage ID	Stage ID	Time	X	Y	Z	X	Y	Z	X	Y	Z	X
1:Stage 1: 0 to 60 Days	1:Stage 1: 0 to 60 Days	60.0	0.0	0.0	0.0	0.0229145	-0.0644341	0.0				
2:Stage 2: 60 to 120 Days	2:Stage 2: 60 to 120 Days	120.0	0.0	0.0	0.0	0.108715	-0.130649	0.0	0.330909	-0.242645	0.0	
3:Stage 3: 120 to 180 Days	3:Stage 3: 120 to 180 Days	180.0	0.0	0.0	0.0	0.214447	-0.188571	0.0	0.76296	-0.418465	0.0	1.479
4:Stage 4: 180 to 240 Days	4:Stage 4: 180 to 240 Days	240.0	0.0	0.0	0.0	0.307651	-0.235387	0.0	1.1787	-0.568153	0.0	2.514
5:Long-term: 240 to 1000 Days	5:Long-term: 240 to 1000 Days	1.0E3	0.0	0.0	0.0	0.352284	-0.399617	0.0	1.39757	-0.957896	0.0	3.028

Incremental Displacement table

An Incremental Displacement history table reports the stage-by-stage deformation of a structure. It tabulates the relative displacements between each construction stage, which can then be used in setting-out of structures built using sequential construction methods.

In the Incremental Displacement table example shown below, the stage identified for each row is the ‘to’ loadcase, with the previous row defining the ‘from’ loadcase for the increment. In the case of the first stage row, the displacement increment is ‘from’ the undeformed mesh. This is true even if particular loadcases are not specified for inclusion, as shown where Row 6 reports the displacement from Stage 2 to Stage 4. Associated nodes are considered active (and therefore valid for inclusion) if they are active in either of the ‘from’ or ‘to’ loadcase stages.

		Point IDs	1	1	1	2	2	2	4	4	4	6
		Point IDs	1	1	1	2	2	2	4	4	4	6
		Node IDs	1	1	1	13	13	13	25	25	25	37
Stage ID	Stage ID	Time	X	Y	Z	X	Y	Z	X	Y	Z	X
1:Stage 1: 0 to 60 Days	1:Stage 1: 0 to 60 Days	60.0	0.0	0.0	0.0	0.0229145	-0.0644341	0.0				
2:Stage 2: 60 to 120 Days	2:Stage 2: 60 to 120 Days	120.0	0.0	0.0	0.0	0.0858001	-0.0662152	0.0	0.272438	-0.171099	0.0	
4:Stage 4: 180 to 240 Days	4:Stage 4: 180 to 240 Days	240.0	0.0	0.0	0.0	0.198937	-0.104737	0.0	0.847795	-0.325509	0.0	1.94
5:Long-term: 240 to 1000 Days	5:Long-term: 240 to 1000 Days	1.0E3	0.0	0.0	0.0	0.044633	-0.16423	0.0	0.218868	-0.389743	0.0	0.514

Notes applicable to all tables

- The first two rows of each table always show the ID of the selected point and the ID of the implied node that the column refers to.
- The first column of each table contains the Loadcase ID of the loadcase used to form the stage, followed by the name of the loadcase.
- If an analysis has a time component (as it does for the example tables shown) an additional Time column will be prepended to the start of the displacement column data. This will be left blank if an analysis has selected loadcases without a time component.
- Where the table is not limited to displacements in the vertical axis direction an additional header row will be included where axes labels related to the global direction of displacement for that column.
- Table values are reported in model units, with the exception of any time-based values.
- Fixed column and row headings (duplicating the information inside the first column and row) are provided for assistance when viewing and scrolling large amounts of data in LUSAS, or when copied to a spreadsheet for third-party graphing purposes.

Steel Frame Design

Overview

Design code checking of steel members is carried out in LUSAS as a results processing operation following the solving of an analysis model, and the assignment of **steel frame design attributes** to selected lines in the model, for a specified **steel design code**. Steel frame design is available for use with selected Bridge and Civil software products only, and only for licences that support this facility.

Prior to carrying out a steel design check

1. **Specify any series of lines as a combined line if necessary.** In LUSAS a steel member is represented by a line in the model that is assumed to span between, and be restrained or supported by its end-points. For situations where a series of lines may represent a single steel member, such as when one beam is supporting cross-beams along its length, the series of lines representing the supporting beam will need to be specified as a combined line by using the **combined line** facility, otherwise design code checking for these members may use incorrect lengths..
2. **Define and assign steel frame design attributes.** These provide design related information and should be assigned assigned to all lines representing steel members. Since the assigned steel design attributes have no impact on the structural analysis they can be assigned after a model has been solved.

Meshing and analysis considerations

Lines representing steel members must be assigned either a 3-dimensional thick beam line mesh or a thick cross section beam line mesh. Line mesh definitions may require different end release conditions dependent upon whether the line representing a steel member to which they will be assigned is considered continuous, has a moment connection at its end or has a simple connection at its end.

For steel design code checking purposes a line mesh should have at least 2 elements and preferably a minimum of 4 elements assigned to each line. Using a single element can cause difficulties with detecting the shape of the bending moment diagrams for buckling checks. Using an excessive element assignment to each line will increase the time required to carry out the design checks.



Checks to a steel design code cannot be carried out if, on the Geometric line attribute dialog, the 'Rotation about centroid' option is set to anything other than 0 degrees, or if the 'Mirror about axis' option is set to anything other than 'None'.

If sections need to be rotated 90 degrees from their library orientated position, a beta angle of 90 degrees should be applied to the section, either during the line mesh assignment, or after assignment by changing the value on the line mesh assignment dialog. After assignment this can be accessed from the [properties panel](#). Applying a local coordinate system is an alternative method that will achieve the same result.

For sections without an axis of symmetry (e.g. unequal angles), changing the direction of the line to which the section has been assigned will effectively achieve a mirror operation.

Note that global analysis, imperfections and material nonlinearities are not considered in a design check, and overall structural stability and effects due to sway etc. are not allowed for in the member design.

Steel frame design attributes

Steel frame design attributes are used to specify additional information about model features (information that is not required for a structural analysis to be carried out) in order to enable design checks to supported design codes. Attributes are defined using the **Attributes> Design> Steel Frame Design...** menu item, which is available in Bridge and Civil software products only. Typical information defined in a steel design attribute includes:

- Section fabrication information and steel grade
- Ratio of net area to gross area of cross section
- Definition of member buckling lengths
- Compression flange restraint
- Buckling length factors

Once defined, a Design attribute entry is created in the Attributes  Treeview ready for assignment to selected lines in a model. Note that the same steel design attribute is used for both EN 1993-1-1:2005 and EN1993-2: 2006 design codes.

Design codes supported

The following design codes are currently supported:

- ❑ **AASHTO LRFD 7th Edition (2014)** AASHTO LRFD Bridge Design Specifications, 7th Edition, American Association of State Highway and Transportation Officials, 2014.
- ❑ **AASHTO LRFD 8th Edition (2014)** AASHTO LRFD Bridge Design Specifications, 8th Edition, American Association of State Highway and Transportation Officials, 2017.
- ❑ **AS 4100-1998 Steel Structures (Australia)** - Australian Standard: AS4100-1998, Steel structures, Standards Australia International Ltd, Sydney.
- ❑ **CSA S6-14 Canadian Highway Bridge Design Code** Canadian Highway Bridge Design
- ❑ **EN1993-1-1: 2005+A1:2014** - EN 1993-1-1:2005 Eurocode 3: Design of steel structures – Part 1-1: General rules and rules for buildings. The Eurocode National Annexes currently supported are:
 - Eurocode Recommended Values (EN 1993-1-1:2005+A1:2014)
 - Finland (SFS-EN 1993-1-1/NA:2007)
 - Ireland (I.S. EN 1993-1-1/NA:2007)
 - Italy (UNI-EN 1993-1-1/NA:2007)
 - Spain (AN/UNE-EN 1993-1-1:2013)
 - United Kingdom (BS EN 1993-1-1:2005+A1:2014/NA+A1:2014)
- ❑ **EN1993-2: 2006** - EN1993-2: 2006 Eurocode 3: Design of steel structures - Part 2: Steel Bridges. The Eurocode National Annexes currently supported are:
 - Eurocode Recommended Values (EN 1993-2:2006)
 - Finland (SFS-EN 1993-2/NA:2010)
 - Ireland (I.S. EN 1993-2/NA:2010)
 - Italy (UNI-EN 1993-2/NA:2007)
 - Spain (AN/UNE-EN 1993-2:2013)
 - United Kingdom (BS EN 1993-2:2006/NA+A1:2012)

Carrying out a steel frame design check

To carry out a design check:

1. Set a suitable loadcase, combination or envelope active. See notes.
2. Choose the **Design > Steel Frame Design** menu item to specify the design code to be used for the check.
3. Add either a contours, diagrams or values layer to the Layers  Treeview
4. On the contours, diagrams or values properties dialog choose the steel frame design code entity and a suitable results component. Utilisation ratios for individual design checks or a design code summary can be chosen. Design check results are plotted for the selected design code and active loadcase

Notes

- Steel design results are considered to be "Derived Components" in LUSAS. This means they may be computed for smart combinations only when a valid primary component is selected. Valid primary components are any of the corresponding thick beam stress resultants $F_x, F_y, F_z, M_x, M_y, M_z$. For more on derived components see [Raw and Derived Components](#).
- When steel design results are requested for a smart combination without a valid primary component no results will be available.
- Where steel design results are requested for smart combination certain design checks will use conservative default values for any parameter relating to the force or moment distribution along the member since this is not available for smart combinations. For example some lateral torsional buckling checks consider the shape of the bending moment diagram in determining the capacity, and in these cases a constant moment is assumed.
- Where a basic combination or envelope contains a smart combination or envelope the above rules apply.
- Steel design results may be specified as a primary component for an envelope which does not contain smart combinations or envelopes. In this case the envelope will provide enveloped design check results for all contained loadsets.
- When a smart combination is selected in the design check summary, LUSAS will perform the design checks taking each of the thick beam components $F_x, F_y, F_z, M_x, M_y, M_z$ as a primary component automatically.

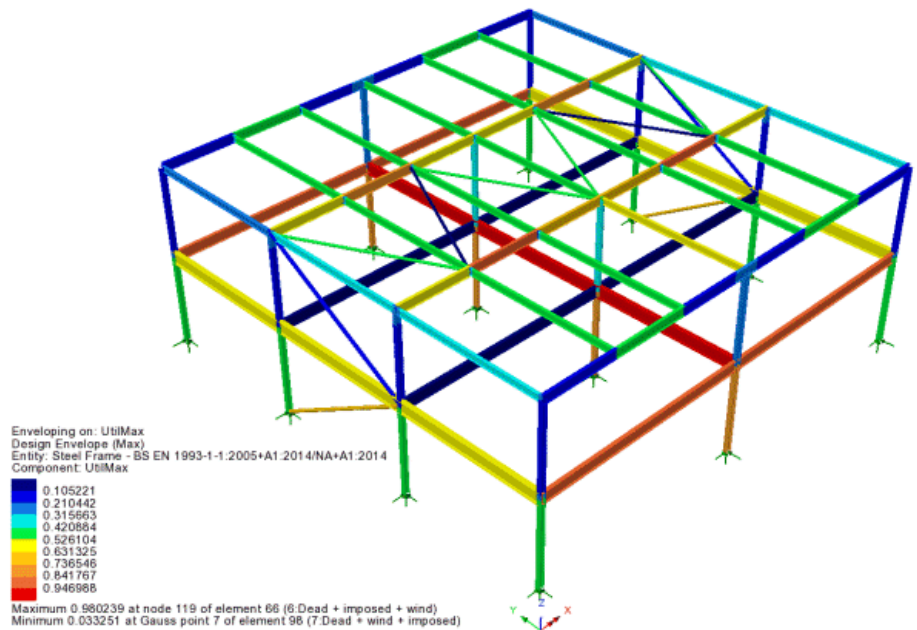

Viewing utilisation results on the model

Steel frame design results can be visualised as Utilisation ratios on a contour or values or diagrams layer for a selected design code and active load case, load combination or design envelope. Results components for individual design checks can be chosen for viewing, as can a design check summary. See [Visualising the Results](#) for details.

Results can also be [tabulated](#) (see below) or added to a model report by using the [Print Results Wizard](#).

Results components

The following tables show the names of LUSAS derived results components and how they relate to currently supported clauses from stated design codes:

AASHTO LRFD 7th Edition

<u>LUSAS results component</u>	<u>AASHTO LRFD 7th Edition</u>
Util(Fx_t)	Utilisation for tension to article 6.8
Util(Fx_c)	Utilisation for compression to article 6.9
Util(My)	Utilisation for flexure about y-y axis to articles 6.10.8 & 6.12.2.2
Util(Mz)	Utilisation for flexure about z-z axis to article 6.12.2.2
Util(Fz)	Utilisation for shear parallel to z-z axis to article 6.10.9.2
Util(Fy)	Utilisation for shear parallel y-y axis to article 6.10.9.2

Application Manual (Bridge, Civil & Structural)

LUSAS results component AASHTO LRFD 7th Edition

Util(Fx_t,My,Mz)	Utilisation for combined tension and flexure to article 6.8.2.3
Util(Fx_c,My,Mz)	Utilisation for combined axial compression and flexure to article 6.9.2.2
UtilMax	Maximum utilisation

AS 4100

LUSAS results component AS 4100

Util(Fx_t)	Utilisation for tension to clause 7.1
Util(Fx_c)	Utilisation for compression to clause 6.2
Util(Fx_c_by)	Utilisation for compression buckling about the y-y axis to clause 6.3
Util(Fx_c_bz)	Utilisation for compression buckling about the z-z axis to clause 6.3
Util(My)	Utilisation for bending about y-y axis - section capacity to clause 5.2
Util(Mz)	Utilisation for bending about z-z axis - section capacity to clause 5.2
Util(My.b)	Utilisation for bending about y-y axis, -lateral torsional Buckling to clause 5.2
Util(Fz)	Utilisation for shear parallel to z-z axis to clause 5.11
Util(Fy)	Utilisation for shear parallel to y-y axis to clause 5.11
Util(Fz,My)	Utilisation for shear and bending interaction for loads parallel to z-z axis to clause 5.12.3
Util(Fy,Mz)	Utilisation for shear and bending interaction for loads parallel to y-y axis to clause 5.12.3
Util(Fx,My,Mz)	Utilisation for bending and axial force - section capacity to clause 8.3
Util(Fx,My,Mz,b)	Utilisation for bending and axial force - section capacity to clause 8.4
UtilMax	Maximum utilisation

CAN CSA S6-14

LUSAS results component	CAN CSA S6-14
Util(Fx_t)	Utilisation for tension to clause 10.8.2
Util(Fx_t,My)	Utilisation for combined tension and bending to clause 10.8.3
Util(Fx_c)	Utilisation for compression to clause 10.9.3
Util(Fx_c,My,Mz)	Utilisation for combined compression and bending to clause 10.9.4
Util(My)	Utilisation for bending about major axis to clause 10.10.2.2, 10.10.3.2
Util(My,b)	Utilisation for bending about major axis to clause C10.10.2.2, C10.10.3.2 - Lateral torsional buckling
Util(Mz)	Utilisation for bending about minor axis to clause 10.10.2.4, 10.10.3.5
Util(Fz)	Utilisation for shear for loads parallel to depth to clause 10.10.5.1
Util(Fz,Mz)	Utilisation for combined shear and moment to clause 10.10.5.2
UtilMax	Maximum utilisation

EN 1993-1-1

LUSAS results component	EN1993-1-1
Util(Fx_t)	Utilisation for tension to clause 6.2.3
Util(Fx_c)	Utilisation for compression to clause 6.2.4
Util(My)	Utilisation for bending about y-y axis to clause 6.2.5
Util(Mz)	Utilisation for bending about z-z axis to clause 6.2.5
Util(Fz)	Utilisation for shear parallel to z-z axis to clause 6.2.6
Util(Fy)	Utilisation for shear parallel to y-y axis to clause 6.2.6
Util(Fz,My)	Utilisation for bending considering combined shear for bending about y-y axis to clause 6.2.8
Util(Fy,Mz)	Utilisation for bending considering combined shear for bending about z-z axis to clause 6.2.8
Util(Fx,My,Mz)	Utilisation for bending and axial force to clause 6.2.9 (this also includes shear effects to clause 6.2.10)
Util(Fx_c,b)	Utilisation for compression member in buckling to clause 6.3.1
Util(My,b)	Utilisation for lateral torsional buckling to clause 6.3.2
Util(Fx_c,My,Mz,b)	Utilisation for combined bending and axial compression buckling to clause 6.3.3
UtilMax	Maximum utilisation

EN 1993-2

LUSAS results component	EN1993-2
Util(Fx_t)	Utilisation for tension to clause 6.2.3
Util(Fx_c)	Utilisation for compression to clause 6.2.4
Util(My)	Utilisation for bending about y-y axis to clause 6.2.5
Util(Mz)	Utilisation for bending about z-z axis to clause 6.2.5
Util(Fz)	Utilisation for shear parallel to z-z axis to clause 6.2.6
Util(Fy)	Utilisation for shear parallel to y-y axis to clause 6.2.6
Util(Fz,My)	Utilisation for bending considering combined shear for bending about y-y axis to clause 6.2.9
Util(Fy,Mz)	Utilisation for bending considering combined shear for bending about z-z axis to clause 6.2.9
Util(Fx,My,Mz)	Utilisation for bending and axial force to clause 6.2.10 (this also includes shear effects to clause 6.2.11)
Util(Fx_c,b)	Utilisation for compression member in buckling to clause 6.3.1
Util(My,b)	Utilisation for lateral torsional buckling to clause 6.3.2
Util(Fx_c,My,Mz,b)	Utilisation for combined bending and axial compression buckling to clause 6.3.3
UtilMax	Maximum utilisation

Utilisation ratios

The utilisation ratio along the length of each member in the model is shown for the visible selected result type for the active loadcase. With regards to utilisations the following should be noted:

- Where a check is not required the utilisation is assumed to be zero (drawn as a blue contour by default). An example of such a check is the effects of lateral torsional buckling for a square hollow section.
- Where a check cannot be carried out because a problem is identified but the solution is outside the scope of the current design check, no contours are plotted.
- Where a check cannot be carried out because the base information is inadequate or unsuitable no result is available and no contours are plotted. Examples of such cases include not assigning a steel design attribute or using an unsupported geometric attribute.

Using the print results wizard

The utilisation results for the same results components that can be viewed on a steel frame design model can be tabulated for viewing and adding to a report using the [print results wizard](#).

Specifying Steel Frame Design results required

The **Design> Steel Frame Design Results** menu item provides a dialog from which selections can be made in order to create a tabular summary of design check results. Settings available are described here.

Extent

To be included in a summary table a line representing a steel beam member must have been assigned a steel beam design attribute. Choose from:

- All members** - all lines in the model.
- Visible members** - only those lines that are visible in the view window.
- From group** - only those lines present in a selected group
- Geometric attribute** - only those lines assigned a particular geometric line attribute

Design checks

A list of design checks applicable to a chosen design code are listed, and can be individually selected by check-box to be included in a summary table.

Options

The results output can be limited to members meeting one of the following criteria:

- All results** - reports on all results for members
- Utilisations > 1.0** - reports on only those members that have exceeded their capacity.
- Only Messages** - reports on members that cannot be checked due to the messages stated, either due to incomplete or incompatible input, or if the check is outside the scope of the design checks.

Loadcases

The results can be limited by loadcase:

- Active** Report on only the active loadcase
- Selected** Report on a user-defined set of loadcases and basic combinations, by pressing the **Select** button.



Display now

When checked, this calculates summary results for the selections made and displays results immediately. By default this option is unchecked.

Name

A Design Code Check Results entry of the stated name is created in the Utilities  Treeview.

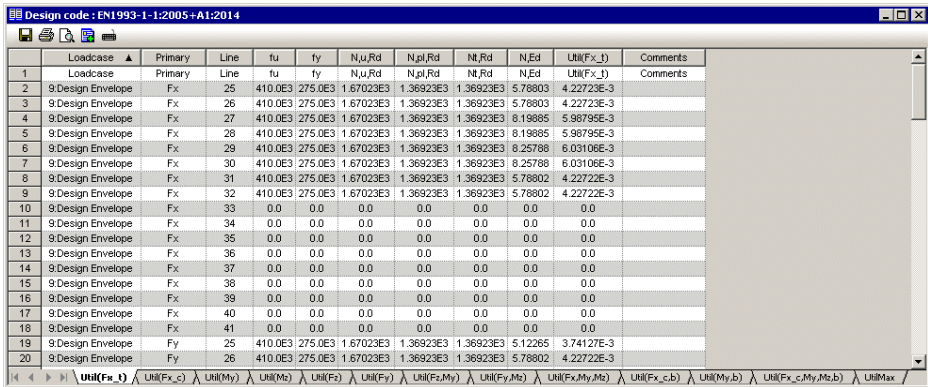

Tabulating Steel Frame Design Results

Right-click on a Steel frame design results entry  in the Utilities  Treeview and select the **Show results** context menu item. Values are calculated and displayed in a tabular format.



	Loadcase	Primary	Line	fu	fy	N _u ,Rd	N _{pl} ,Rd	N _t ,Rd	N _{Ed}	U _{L1} (F _{x_1})	Comments
1											
2	9.Design Envelope	Fx	25	410.0E3	275.0E3	1.67023E3	1.36923E3	1.36923E3	5.78803	4.22723E-3	
3	9.Design Envelope	Fx	26	410.0E3	275.0E3	1.67023E3	1.36923E3	1.36923E3	5.78803	4.22723E-3	
4	9.Design Envelope	Fx	27	410.0E3	275.0E3	1.67023E3	1.36923E3	1.36923E3	8.19685	5.98795E-3	
5	9.Design Envelope	Fx	28	410.0E3	275.0E3	1.67023E3	1.36923E3	1.36923E3	8.19685	5.98795E-3	
6	9.Design Envelope	Fx	29	410.0E3	275.0E3	1.67023E3	1.36923E3	1.36923E3	8.25788	6.03106E-3	
7	9.Design Envelope	Fx	30	410.0E3	275.0E3	1.67023E3	1.36923E3	1.36923E3	8.25788	6.03106E-3	
8	9.Design Envelope	Fx	31	410.0E3	275.0E3	1.67023E3	1.36923E3	1.36923E3	5.78802	4.22722E-3	
9	9.Design Envelope	Fx	32	410.0E3	275.0E3	1.67023E3	1.36923E3	1.36923E3	5.78802	4.22722E-3	
10	9.Design Envelope	Fx	33	0.0	0.0	0.0	0.0	0.0	0.0	0.0	
11	9.Design Envelope	Fx	34	0.0	0.0	0.0	0.0	0.0	0.0	0.0	
12	9.Design Envelope	Fx	35	0.0	0.0	0.0	0.0	0.0	0.0	0.0	
13	9.Design Envelope	Fx	36	0.0	0.0	0.0	0.0	0.0	0.0	0.0	
14	9.Design Envelope	Fx	37	0.0	0.0	0.0	0.0	0.0	0.0	0.0	
15	9.Design Envelope	Fx	38	0.0	0.0	0.0	0.0	0.0	0.0	0.0	
16	9.Design Envelope	Fx	39	0.0	0.0	0.0	0.0	0.0	0.0	0.0	
17	9.Design Envelope	Fx	40	0.0	0.0	0.0	0.0	0.0	0.0	0.0	
18	9.Design Envelope	Fx	41	0.0	0.0	0.0	0.0	0.0	0.0	0.0	
19	9.Design Envelope	Fy	25	410.0E3	275.0E3	1.67023E3	1.36923E3	1.36923E3	5.12265	3.74127E-3	
20	9.Design Envelope	Fy	26	410.0E3	275.0E3	1.67023E3	1.36923E3	1.36923E3	5.78802	4.22722E-3	

Adding steel design code results to a main report

Steel frame design tabular results may be saved for use with Microsoft Excel or saved to a text format. Results can also be added to a main report either by using the **Add to report**  button, or by using the **Add to report** context menu item for the named Print Results Wizard entry  in the Utilities  Treeview. With this method, each time the main report is generated the design summary data will be updated to match the current state of the model.

Member reports

A member report can be generated to investigate the design calculations carried out for a single particular member, showing calculations made and referencing clauses and equations from the code. Design code member reports can only be created for loadcases, basic combinations and valid smart combinations.

- Use the **Design > Steel Frame Design Report > Member** menu item to report design checks for a pre-selected member. The values written for each design check in the member report are the most onerous of the results for any internal (calculation) point along a member.

- Use the **Design > Steel Frame Design Report > Member (Selected IP)** menu item to report on design checks and results at a chosen location on a member (defined by an element and internal point).

EN1993-1-1:2005+A1: 13 design checks

Design Calculation

Utilisation for combined bending and axial compression buckling 6.3.3(4)

$$Util(Fx.c, My, Mz, b) = \max(Fx.c, My, Mz, b_1, Fx.c, My, Mz, b_2) = \max((1.24594), (1.32695)) = 1.32695$$

Combined bending and axial compression buckling check 1 Exp (6.61)

$$Fx.c, My, Mz, b_1 = \frac{|N_{Ed}|}{\chi_{LT} \frac{M_{yRk}}{Y_{M1}}} + k_{yy} \frac{|M_{y,Ed,max} + \Delta M_{y,Ed}|}{\chi_{LT} \frac{M_{yRk}}{Y_{M1}}} + k_{yz} \frac{|M_{z,Ed,max} + \Delta M_{z,Ed}|}{\chi_{LT} \frac{M_{yRk}}{Y_{M1}}}$$

$$= \frac{|(22.2515)|}{(0.933579)(1.37705E3)} + (0.952769) \frac{|(-275.379) + (0.0)|}{(1.0) \frac{(213.113)}{(1.0)}} + (0.63583) \frac{|(-0.713131E-15) + (0.0)|}{(1.0) \frac{(40.2954)}{(1.0)}}$$

= 1.24594

Moment about y-y axis due to shift of centroidal axis according to 6.2.9.3 Table 6.7

Moment about z-z axis due to shift of centroidal axis according to 6.2.9.3 Table 6.7

Combined bending and axial compression buckling check 2 Exp (6.62)

$$Fx.c, My, Mz, b_2 = \frac{|N_{Ed}|}{\chi_{LT} \frac{M_{zRk}}{Y_{M1}}} + k_{zy} \frac{|M_{y,Ed,max} + \Delta M_{y,Ed}|}{\chi_{LT} \frac{M_{zRk}}{Y_{M1}}} + k_{zz} \frac{|M_{z,Ed,max} + \Delta M_{z,Ed}|}{\chi_{LT} \frac{M_{zRk}}{Y_{M1}}}$$

$$= \frac{|(22.2515)|}{(0.340781)(1.37705E3)} + (0.993906) \frac{|(-275.379) + (0.0)|}{(1.0) \frac{(213.113)}{(1.0)}} + (1.05972) \frac{|(-0.713131E-15) + (0.0)|}{(1.0) \frac{(40.2954)}{(1.0)}}$$

= 1.32695

Adding a member report to a main report



Member report pages may be added to a main report using the **Add to report** button. All design checks for a particular member will be included in the report. Each time the main report is generated the member report data will be updated to match the current state of the model.

Changing steel member properties

Changes can be made to **steel frame design attributes** (for example, changing a grade of steel, or assigning a different geometric line property to a line) without requiring a model to be re-solved. For this situation, design checks are automatically re-computed to show illustrative effects of making that change to the model. If this is not required, turn-off the display of any results layers (contours, values, diagrams) in the Layers Treeview prior to making any changes.

A final re-solve of an updated model should generally be done to arrive at 'final' design values.

Design check errors

In carrying out a design check to a particular code design check errors may sometimes be encountered for certain members as a result of either user-error in the design attribute definition, or from limitations of the design code or the implementation of the

design code within LUSAS. Selected design check failure messages that may be seen and the actions that are required to be taken are shown in the following tables:

General errors

Failure message	More information / Action required
Unknown error	Contact LUSAS technical support
Geometric attribute profile is currently outside the scope of the design checks	The section shape is not one that is checked by LUSAS
Geometric attribute rotation must be set to 0. If a rotation is required use Mesh Attribute Beta angle	Revisit the Attributes> Geometric > Line dialog for that member and correct the angular rotation
The Geometric Attribute mirroring must be set to none.	Revisit the Attributes> Geometric > Line dialog for that member and correct the mirror about axis setting
Section profile and section fabrication from Design Attribute are incompatible	Revisit the Attributes > Design > Steel Frame Design dialog and make suitable changes

AASHTO LRFD 7th Edition

Failure message	More information / Action required
Material strength is outside scope of design code	Limitation of design code
Limiting slenderness ratio for a noncompact flange is exceeded	Design check limit exceeded - adjust member size
Slenderness limit for tension / compression member is not satisfied	Design check limit exceeded - adjust member size
Cross-section proportions are not within acceptable limits	Limitation of design code
Slenderness of channel elements is not within acceptable limits	Design check limit exceeded - adjust member size
Axial compression force exceeds Euler buckling load about y axis for braced / unbraced frame	Increase section capacity of affected members or apply additional restraint
Axial compression force exceeds Euler buckling load about z axis for braced / unbraced frame	Increase section capacity of affected members or apply additional restraint
Rolled mono-symmetrical I-sections are currently outside the scope of the design checks	Limitation of the current implementation of the design code within LUSAS
Built up standard I-sections, channel sections and tee sections are currently outside the scope of the design checks	Limitation of the current implementation of the design code within LUSAS
Flexure of tees about z-axis is outside the scope of the design checks	Limitation of the current implementation of the design code within LUSAS
Shear for the chosen section is currently outside the scope of the design checks	Limitation of the current implementation of the design code within LUSAS
For circular tubes, including round HSS, D/t shall not exceed $0.45E/F_y$	Limitation of design code

AS 4100

Failure message	More information / Action required
Lateral torsional buckling checks to RHS where $B > D$ are currently outside the scope of the design checks	Limitation of the current implementation of the design code within LUSAS
Plate thickness outside the scope of AS4100	Limitation of design code
Incompatibility between Material and/or Section Fabrication and/or Section Type	Limitation of design code
Section is not compact.	Limitation of design code
Axial section capacity is exceeded.	Limitation of design code
Bending moment capacity is exceeded	Limitation of design code
Axial member capacity is exceeded.	Limitation of design code
Shear capacity in M-V interaction is less than 0	Limitation of design code
Cross section not constant	Limitation of the current implementation of the design code within LUSAS
Lateral torsional buckling checks for cantilever members are currently outside the scope of the calculations	Limitation of the current implementation of the design code within LUSAS

CAN CSA S6-14

Failure message	More information / Action required
The slenderness ratio of a tension member exceeds limit of slenderness	Design check limit exceeded - adjust member size
The slenderness ratio of a compression member exceeds limit of slenderness	Design check limit exceeded - adjust member size
This check is not covered by CAN/CSA-S6-14	Limitation of design code
Non-uniform members are currently outside the scope of the design checks	Limitation of the current implementation of the design code within LUSAS
This profile classification is currently outside the scope of the design checks	Limitation of the current implementation of the design code within LUSAS
Class 4 sections currently not designed	Limitation of the current implementation of the design code within LUSAS

EN1993-1-1 and EN 1993-2

Failure message	More information / Action required
Lateral torsional buckling checks to RHS where $b > d$ are currently outside the scope of the design checks	Limitation of the current implementation of the design code within LUSAS
Section profile and section fabrication from Design Attribute are incompatible	Make the design attribute entry compatible
Ductility requirements are not met for user defined material	Limitation of design code.
Section thickness is outside the scope of Table 3.1 / the product standard	Limitation of design code. Section thickness is greater than that in Table 3.1 / the product standard
EN 1993-1-1 gives basic design rules for steel structures with material thicknesses greater than or equal to 3mm	Limitation of design code. Material thickness is too small for codified checks
Transverse stiffener should be provided at supports where h_w/t_w limit is exceeded.	Provide a transverse stiffener, or increase section size to try and avoid use of one
Design resistance for bending about y-y / z-z axis is exceeded	Limitation of design code. Increase section capacity of affected members
Design resistance for shear parallel to z-z / y-y axis is exceeded	Limitation of design code. Increase section capacity of affected members
Design resistance for compression is exceeded	Limitation of design code. Increase section capacity of affected members
Shear area cannot be determined	Limitation of the current implementation of the design code within LUSAS
Non-uniform members are currently outside the scope of the design checks	Limitation of the current implementation of the design code within LUSAS
Steel grades greater than S460 are currently outside the scope of the calculations	Limitation of the current implementation of the design code within LUSAS
Lateral torsional buckling checks for cantilever members are currently outside the scope of the calculations	Limitation of the current implementation of the design code within LUSAS
Class 4 tubular sections are not currently designed	Limitation of the current implementation of the design code within LUSAS
Insufficient iterations available to complete calculation of effective section properties	Limitation of the current implementation of the design code within LUSAS
Design of RHS for shear buckling is outside scope	Limitation of the current implementation of the design code within LUSAS
Design of angle sections is only carried out for axial loads	Limitation of the current implementation of the design code within LUSAS
Eccentric effects of Class 4 angular sections are not currently considered	Limitation of the current implementation of the design code within LUSAS
Both legs of angle must have same thickness	Limitation of the current implementation of

	the design code within LUSAS
Design attribute defined only applies to angles	Limitation of the current implementation of the design code within LUSAS
Design attribute defined does not apply to angles	Limitation of the current implementation of the design code within LUSAS

Worked example

- See Help> Help Topics> Worked Examples > For Design Option > ‘Steel Frame Design’.

Steel Frame Design - Code Selection

To carry out a steel frame design check a design code must be selected by using the **Design> Steel Frame Design** menu item. This is available for use with selected Bridge and Civil software products only, and only for licences that support this facility.

Previous selection of a steel design code is required in order to be able to run a steel design check and view results for that design code. See [Steel Frame Design - Code Checking](#) for the procedure involved.

Steel design checks for the following steel design codes can be obtained by creating and assigning steel frame design attributes to those lines in a model that represent steel members.

- ❑ **AASHTO LRFD 7th Edition (2014)** AASHTO LRFD Bridge Design Specifications, 7th Edition, American Association of State Highway and Transportation Officials, 2014.
- ❑ **AASHTO LRFD 8th Edition (2017)** AASHTO LRFD Bridge Design Specifications, 8th Edition, American Association of State Highway and Transportation Officials, 2017.
- ❑ **AS 4100-1998 Steel Structures (Australia)** - Australian Standard: AS4100-1998, Steel structures, Standards Australia International Ltd, Sydney.
- ❑ **CSA S6-14 Canadian Highway Bridge Design Code** Canadian Highway Bridge Design
- ❑ **EN1993-1-1: 2005+A1:2014** - EN 1993-1-1:2005 Eurocode 3: Design of steel structures – Part 1-1: General rules and rules for buildings. This selection permits the selection of a National Annex and optional changing of code parameters.
 - Eurocode National Annexes currently supported are: “Eurocode Recommended Values”, Finland, Ireland, Italy, Spain, United Kingdom.
 - For each Eurocode National Annex there are a number of Nationally Determined Parameters (NDPs) listed.

- Recommended Values (RVs) are usually given in the main Eurocode document.
 - Numeric Values listed may be edited but note that such an option may not be given in the respective National Annex.
 - Only those NDP values used in the design calculations are shown. For example the values for α_{LT} are determined from Table 6.3 and vary from member to member and as such cannot be displayed.
- **EN1993-2** - EN 1993-2: 2006 Eurocode 3: Design of steel structures – Part 2: Steel Bridges. This selection permits the selection of a National Annex and optional changing of code parameters.
- Eurocode National Annexes currently supported are: “Eurocode Recommended Values”, Finland, Ireland, United Kingdom.
 - For each Eurocode National Annex there are a number of Nationally Determined Parameters (NDPs) listed.
 - Recommended Values (RVs) are usually given in the main Eurocode document.
 - Numeric Values listed may be edited but note that such an option may not be given in the respective National Annex.
 - Only those NDP values used in the design calculations are shown. For example the values for α_{LT} are determined from Table 6.3 and vary from member to member and as such cannot be displayed.

Details of any particular settings for individual design codes are described on the steel design attribute for that design code.

Steel Frame Design Attributes

Steel Frame Design Attributes are used to specify member design values and in particular member lengths and end conditions used in determination of buckling capacities. They are assigned to line features in a model to specify additional information about those features (information that is not required for a structural analysis to be carried out) in order to enable **steel frame design** checks to be carried out to a supported design code.

Steel frame design attributes can be defined using the **Attributes> Design> Steel Frame Design...** menu item that is available for use with selected Bridge and Civil software products for licences that support this facility, and only if a model **analysis category** of 3D is in use. The steel product standards that are available for selection on the resulting dialog depend upon the steel design code selected from the dialog displayed when using the **Design> Steel Frame Design** menu item.

The following design codes are currently supported:

- ❑ **AASHTO LRFD 7th Edition** AASHTO LRFD Bridge Design Specifications, 7th Edition, American Association of State Highway and Transportation Officials, 2014.
- ❑ **AASHTO LRFD 8th Edition** AASHTO LRFD Bridge Design Specifications, 8th Edition, American Association of State Highway and Transportation Officials, 2017.
- ❑ **CSA S6-14 Canadian Highway Bridge Design Code** Canadian Highway Bridge Design
- ❑ **EN1993-1-1: 2005+A1:2014** - EN 1993-1-1:2005 Eurocode 3: Design of steel structures – Part 1-1: General rules and rules for buildings.
- ❑ **EN1993-2: 2006** - EN1993-2: 2006 Eurocode 3: Design of steel structures - Part 2: Steel Bridges. The Eurocode National Annexes currently supported are:
- ❑ **AS 4100-1998 Steel Structures (Australia)** - Australian Standard: AS4100-1998, Steel structures, Standards Australia International Ltd, Sydney.

Defining member buckling lengths

It is possible for a member to have unsymmetric restraints leading to different buckling lengths about each axis. In LUSAS a member's unrestrained length may be taken from either a line or a **combined line**. This allows a member to be defined by more than one line and multiple buckling lengths. The choice of whether to use the line length or combined line length for each buckling phenomenon is specified in the Steel Frame Design Attribute dialog. Care is required in defining and assigning steel frame design attributes in order to ensure that the correct buckling lengths are assigned for all valid situations in the model. It is recommended that the concept is understood first in a test model as the unbraced length can easily be underestimated.

Examples of member buckling lengths

Example 1 below, shows the invalid use of a combined line to define a member. Restraint is provided in the major and minor directions at each end of the member and in the minor direction only at the point where member (Line 4) is connected. In the steel frame design attribute the buckling length is set in the attribute to use the combined line length about the major axis (between end restraints) and to use the individual line lengths about the minor axis. The unrestrained length in the minor direction will be taken as line length. This would be correct for the first line (Line 1) up to the restraint but the unrestrained length of the second and third lines (Line 2 and Line 3) will be taken erroneously as their individual lengths, as opposed to a length for the sum of these two lines. Members should therefore not be made up of a series of lines where there are no intermediate points of restraint at the end points of each line. Additionally a member should only ever be defined with a single combined line, because overlapping combined lines will cause errors in the determination of buckling lengths.

Examples 2, 3 and 4 show valid uses of combined lines and lines to calculate buckling lengths.

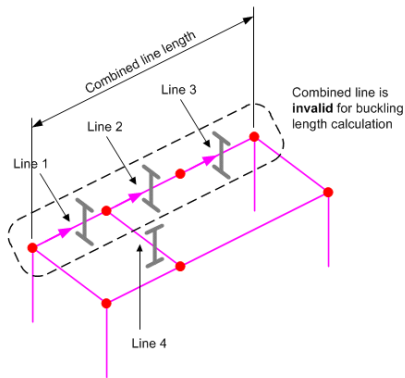

For the member highlighted	Buckling length is obtained from...
Major axis	Invalid calculation
Minor axis	Invalid calculation

Example 1: Invalid use of a combined line to define a member (when the ends of some internal lines defining the member have no restraint)

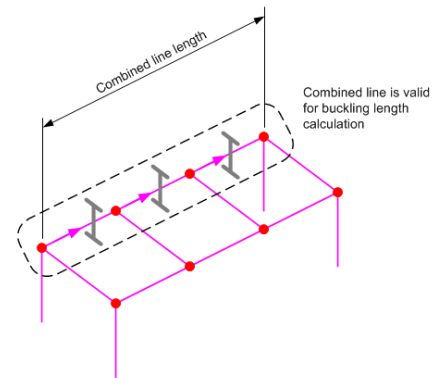

For the member highlighted	Buckling length is obtained from...
Major axis	Combined line
Minor axis	Line

Example 2: Valid use of a combined line to define a member using multiple lines (when the end of each line defining the member is restrained)

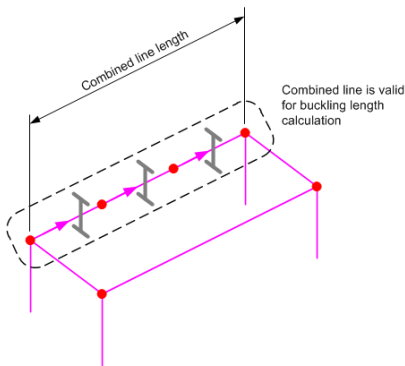

For the member highlighted	Buckling length is obtained from...
Major axis	Combined line
Minor axis	Combined line

Example 3: Valid use of a combined line to define a member when no internal restraints are provided for all lines defining that member.

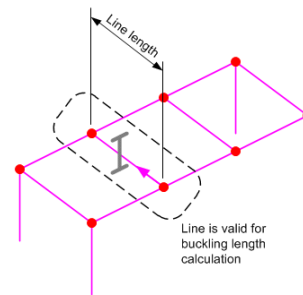

For the member highlighted	Buckling length is obtained from...
Major axis	Line
Minor axis	Line

Example 4: Valid use of a line for a single member

Notes

- Member lengths for buckling are always taken from the actual line or combined line length and will ignore the presence of any **rigid end zones**. This is a conservative assumption.
- The steel frame design attribute requires the lines that are present in a combined line to all be in the same direction.
- When geometry data is imported from third-party systems, it may be the case that individual lines are created inside Modeller instead of a single line between two points. In such situations it may be possible to create combined lines to define members depending upon restraints used, otherwise, if not appropriate, the line geometry should be simplified with a single line representing a single member.
- See specific design codes for details of buckling lengths.

Steel Frame Design Attribute Settings for AASHTO LRFD 7th (2014)

AASHTO LRFD 7th Edition (2014) steel frame design attributes can be defined by using the **Attributes > Design > Steel Frame Design** menu item after previously selecting that code from the **steel frame design code selection** dialog. After definition, steel frame design attributes need to be assigned to the appropriate lines in a model that represent steel members.

AASHTO LRFD 7th Edition Steel Frame Design

Section manufacture

Steel product standard: AASHTO M270M/M270

Section fabrication: Rolled section

Steel grade: Grade 36

Welding process: Electric resistance welded

Axial

Ratio of net area to gross area: 0.6

Reduction factor for shear lag U: 0.6

Bolt hole type: Punched full size

Member type in analysis: Primary

Stress reversal: Possible

Compression

	Major axis	Minor axis	Torsion
Unbraced / buckling length from	Line	Line	Line
User defined length			
End conditions	c	c	
Design value of K	1.0	1.0	1.0

Flexure

Member type: All other cases

Unbraced length from: Line

Bracing type top: Discretely braced

Sidesway in y direction: Unbraced

User defined length:

Bracing type bottom: Discretely braced

Sidesway in z direction: Unbraced

Name: Des1 (new)

OK Cancel Apply Help

Section manufacture

- Steel product standard** Supported standards are listed, as well as a User-defined option which permits defining Yield stress (F_y) and Tensile strength (F_u) for all components.
- Section fabrication method** and **Steel grade** settings are required. For some fabrication methods a Hybrid section can be defined utilising different steel grades for the top and bottom webs and flange.
- Edit** This button is only available for user-defined and hybrid settings.
- Welding process** can be specified for cold or hot formed welded section fabrication methods.

Axial

- Ratio of net area to gross area of cross section** A suitable value for the factor can be calculated. This is conservatively applied to the whole length of a member to allow for a reduction of gross area of cross-section as a result of holes or notches in members. It should be modified on a case-by-case basis.

- Reduction factor for shear lag** U A value from Table 6.8.2.2-1 of the code.
- Bolt hole type** Punched full size, or Drilled or sub-punched and reamed.
- Member type in analysis** and **Stress reversal** selections are necessary to carry out the limiting slenderness ratio checks (section 6.8.4). The default option for both cases (primary member subject to possible stress reversals) results in the most onerous slenderness limit.

Compression buckling

- Unbraced / buckling length factors** When carrying out buckling checks the Design attribute applies factors to the member length to determine the buckling length about both the major and minor axes. A buckling length for torsional buckling must also be defined. Points of restraint can be different for each of the three buckling lengths and so the base length (unfactored) can be different in each case. The unbraced / buckling member length is derived from either a single line, or from a **combined line** (that represents a member that is defined by a series of lines). See **Defining Member Buckling Lengths** for more information. Alternatively, a **User defined length** can be specified for major axis, minor axis or torsional buckling.
- End conditions** These determine the effective length factor, K, as used in calculation of the elastic critical buckling resistance, P_e . The letters in the drop lists refer to those used in Table C4.6.2.5-1. Alternatively these factors can be manually input by selecting 'Other' as End conditions.

Flexural buckling

- Member type** is used to specify a member as either: 'Unbraced cantilever', or 'All other cases'.
- Unbraced length from** The unbraced / buckling member length is derived from either a single line, or from a **combined line** (that represents a member that is defined by a series of lines). See **Defining Member Buckling Lengths** for more information. Alternatively, a **User defined length** can be specified.
- Bracing type top** and **Bracing type bottom** requires a selection of either 'Discretely braced' or 'Continuously braced'.
- Sidesway in y direction** and **Sidesway in z direction** requires a selection of either 'Braced' or 'Unbraced'.

Name

- This defines the design attribute name that is created in the Attributes  Treeview ready for assignment to selected lines representing steel members in a model.

Summary of steel frame design checks made to AASHTO LRFD 7th

Assignment of AASHTO LRFD 7th steel frame design attributes to lines representing steel members permits the following design checks to be carried out on the member cross-section (with reference to clauses from the design code):

- Tension (article 6.8.2)
- Compression (article 6.9.2)
- Flexure about major axis including lateral torsional buckling check (articles 6.10.8 and 6.12.2.2)
- Flexure about minor axis (article 6.12.2.2)
- Shear (articles 6.10.9 and 6.12.1.2.3)
- Tension and flexure (article 6.8.2.3)
- Compression and flexure (article 6.9.2.2)
- A summary “check” with the largest utilisation from all other design checks

Design checks are currently carried out for the following section profiles:

- Rolled and fabricated doubly symmetric I-sections / H-sections with constant thickness flanges
- Fabricated singly symmetric I-sections /H-sections with constant thickness flanges
- Rolled channel sections with sloped flanges
- Rolled Tee sections with sloped and constant thickness flanges
- Hot formed and cold formed round HSS
- Hot formed and cold formed rectangular HSS

General Notes

- The current implementation is limited to the general requirements of AASHTO 7th. Appendix A6 is not implemented.
- The Service Limit State (article 6.10.4) is not considered.
- Constructability requirements for I-sections (article 6.10.3) are currently not considered.

Implementation Notes

- See [Implementation Notes for Steel Frame Design Checks to AASHTO LRFD 7th \(2014\)](#) for more information

Implementation Notes for Steel Frame Design Checks to AASHTO LRFD 7th (2014)

References cited are provided at the foot of this topic.

Local Axes

In AASHTO the local axis along a member is taken in the z direction, while the cross section axes are taken as x and y. As this is not consistent with the naming convention used within LUSAS Modeller all parameters in AASHTO 7th with reference to a local axis are modified appropriately in the rendered calculations. The following summarises the modifications:

AASHTO 7th notation Modeller & rendered notation

x-axis	y-axis
y-axis	z-axis
z-axis	x-axis

It should also be noted for channel sections that AASHTO takes the axis of symmetry as the y-axis (which is modified in LUSAS Modeller to be the z-axis).

Hollow sections from the AISC 14 product standard

In accordance with article 6.12.2.2.2 hollow sections held in the geometric attribute library for AISC 14 have a reduction factor (with a value of 0.93) applied to the thickness and in the calculation of section properties. However, as implemented, this reduction factor will also be applied when a steel design check is carried out, when it should not be applied. As a result conservative results will be obtained.

Design Checks for Tension

On the steel frame design attribute dialog for [AASHTO LRFD 7th Edition](#), information must be entered with respect to whether the member type is classified as “primary” or “secondary” and whether stress reversals are possible. This information is necessary to carry out the limiting slenderness ratio checks (section 6.8.4). The default option for both cases (primary member subject to stress reversals) results in the most onerous slenderness limit.

Design Checks for Compression

When calculating Q_a for a round HSS, a reduction factor greater than 1 can be obtained due to rounding effects in equation 6.9.4.2.2-12. An upper limiting value of 1.0 is applied to the value of Q_a to resolve this issue.

When calculating the effective width b_e for a rectangular HSS compression all elements are treated as flanges and Eq. 6.9.4.2.2-10 is used. The subscripts “bre” and “dep” are used to distinguish between short side and long side of sections defined using the geometric section library respectively. Where a section is defined using the section property calculator these subscripts apply to the sides defined by parameters B and D respectively.

Flexure

- ❑ **Sign convention in flexure** Different sign conventions for tensile and compressive stresses due to flexure are used in LUSAS Modeller from AASHTO. The convention in Modeller is adopted to maintain consistency within the software. However occasionally situations arise where maintaining the Modeller sign convention is not practical as it would lead to a re-interpretation of equations as provided in AASHTO 7th. An example of this is the calculation of C_b values of I-sections. In these situations the relevant stresses are factored by -1.
- ❑ **Maximum compression flange stress in web bend-buckling resistance** When calculating the Web bend-buckling resistance, the commentary (C6.10.1.9.1) notes that "resistance is checked generally against the maximum compression-flange stress due to factored loads". In this context maximum compression flange stress is taken to apply to the maximum value in the depth of the section and not the maximum along the length of the member.
- ❑ **Lateral bending stresses in I-sections** It appears that the 0.06 value in equation 6.10.1.6-1, which relates to discretely braced flanges, is a misprint and should in fact be 0.6. The value of 0.6 has been adopted in this implementation.
- ❑ **Rectangular HSS** The nominal flexural resistance for lateral torsional buckling is given by equation 6.12.2.2.2-1. While lateral torsional buckling does not apply to the weak axis the check is carried out to both axes. This is to accommodate sections defined using the section property calculator where $B > D$, in which case the y-y axis is the weak axis. The effective section modulus is determined using the conservative approach noted in C6.12.2.2.2 whereby the effective width is applied to the tension flange as well as the compression flange. The section modulus is then determined from first principles.

Lateral Torsional Buckling

The commentary to 6.10.1.6 notes that the use of coincident values of f_l , f_{bu} and μ can be used although the use of maximum values in an unbraced length will give conservative results. In applying the LUSAS design check calculations, the coincident effects are used.

- ❑ **Moment gradient modifier, C_b** For a given cross-section C_b is assessed for the compression flange. Therefore where a member is bent in double curvature there will be two values of C_b – one for each flange. The Commentary in C6.10.8.2.3 notes that the calculations provided to determine C_b neglect the effect of the location of the applied load relative to the mid-height of the section. The user is directed to two publications – Galambos [W1] and Dowswell [S1] – for methods on how to deal with different situations. These situations are outside the scope of the current design checks.
- ❑ **Warping torsional constant, C_w** The design checks for lateral torsional buckling of channel sections uses the values of C_w as calculated by LUSAS Modeller rather than the value in equation 6.12.2.2.5-6 of AASHTO 7th.

Design Checks for Shear

- ❑ **Shear in y and z directions** The following shear checks are explicitly considered in AASHTO:
 - Shear in the webs of I-sections (Fz effects) for both doubly symmetric and singly symmetric sections – from clause 6.10.9.2
 - Shear in flanges of I-sections (Fy effects) – from clause 6.12.1.2.3a
 - Shear in stems of tee section (Fz effects) – from clause 6.12.1.2.3a
 - Shear in web of rectangular HSS (Fy and Fz effects) – from clause 6.12.1.2.3b
 - Circular tubes including round HSS – from clause 6.12.1.2.3c. The same check is applied to Fy and Fz effects.

AISC 360-10 applies the same method to webs of channels as for webs of I sections which is practically identical to that for I-sections in AASHTO (there are some minor adjustments to the ratio of shear-buckling resistance to shear yield strength). This method is therefore adopted for Fz to channel sections.

Section G7 of AISC 360-10 deals with weak axis shear to doubly symmetric (standard I-sections) and singly symmetric shapes and is the same as the requirements clause 6.12.1.2.3a of AASHTO 7th. This method is therefore applied to the flanges of channels.

- ❑ **Specified minimum yield strength of web** Calculation of the plastic shear force, V_p , as given by equation 6.10.9.2-2 is dependent upon the specified minimum yield strength of the web, F_{yw} . The ratio of the shear buckling resistance to the shear yield strength, C , is also dependent upon F_{yw} . For rolled sections, F_{yw} is taken as the specified minimum yield strength. For a hybrid section with loads parallel to the web the specified minimum yield strength of the web is used. However for the case of a hybrid section with loads parallel to the flange the strength of each flange is considered separately. In this case the term F_{yw} is replaced with $F_{yf,top}$ and $F_{yf,bot}$ as appropriate. This nomenclature differs from AASHTO 7th, which only makes reference to F_{yw} .

- ❑ **Parameter D when calculating nominal shear resistance** For open sections, the value of D is taken as the distance between flanges. In the case of tee sections D is taken as the distance from the tip of the stem to the underside of the flange.
- ❑ **Shear resistance of rectangular HSS** When considering shear in a rectangular HSS, an element resisting shear is referred to as a web. Therefore in a RHS member resisting shear from both the y and z directions, the long sides will be referred to as webs when considering shear in the z direction and the short sides will be referred to as webs when considering shear in the y direction.
- ❑ **Shear resistance of round HSS and parameter L_v** L_v is taken as the longer distance from the point of zero shear to the end of the beam. This approach may result in values of L_v being adopted which do not match description in AASHTO (distance between points of maximum and zero shear), although the results are conservative.

Biaxial Bending Checks

There is no explicit check for biaxial bending in AASHTO 7th. However sections 6.8.2.3 and 6.9.2.2 consider biaxial bending in conjunction with axial tension and axial compression respectively. For members with no axial load, these checks are applied even though they are part of the Tension Members section and Compression Members section respectively.

Bending about the z-axis is outside the scope of the design checks for tee sections and therefore biaxial bending checks are outside the scope of the checks. However the combined effects of bending about the y-axis and tension / compression are checked but this requires equations 6.8.2.3-1 and 6.8.2.3-2 or 6.9.2.2-1 and 6.9.2.2-2 to be modified by omitting the M_{uz}/M_{rz} part as appropriate.

Combined Axial Compression and Flexure

When carrying out the combined axial compression and flexure check, clause 6.9.2.2 allows the values of the factored flexural moments about the y-axis and z-axis to be determined by either:

- A second order elastic analysis that accounts for the magnification of moment caused by factored axial load
- The approximate single step adjustment specified in Article 4.5.3.2.2b

The design checks assume that a first order linear elastic analysis has been carried out and so the single step adjustment is applied to the bending moments. The method is simplified such that the larger value of δ_b and δ_s is assigned to the total moment on the compression member. The value of C_m used in equation 4.5.3.2.2b-3 is conservatively taken as 1.0 in all cases. When determining the moment magnification the calculation of δ_s is based on individual columns i.e. they are assumed not to be connected integrally to the same superstructure as described in 4.5.3.2.2b.

Effective length factor, K

The choice of End conditions on the Steel Design Attribute dialog is used to determine the effective length factors used in calculation of the elastic critical buckling resistance, P_e . The letters in the drop lists refer to those used in Table C4.6.2.5-1 and can be summarised as follows:

End condition selected in Modeller	Design K value	End conditions to be considered
a	0.65	Rotation fixed and translation fixed at both ends
b	0.80	Rotation fixed and translation fixed at one end, rotation free and translation fixed at other end
c	1.00	Rotation free and translation fixed at both ends
d	1.20	Rotation fixed and translation fixed at one end, rotation fixed and translation free at other end
e	2.10	Rotation fixed and translation fixed at one end, rotation free and translation free at other end
f	2.00	Rotation free and translation fixed at one end, rotation fixed and translation free at other end

For combined axial compression and flexure the effective length factor, K, is required for braced frame and unbraced frame conditions in calculating P_e . The K values are determined using the method set out in the commentary of AASHTO 7th and equations C4.6.2.5-4, C4.6.2.5-5 and C4.6.2.5-6 as appropriate. In applying these equations the stiffness of members connected to each end of the member under consideration must be considered in the local y and z planes. The effect of out of plane members connected at the end of a member is ignored.

Where a support is provided at the end of a member the stiffness ratio G_a or G_b is taken as 1.0 for a rigid end condition and 10 for a pinned end. A support is considered as rigid if any one of the rotations in the X, Y or Z directions is fixed or has a spring stiffness. A support is considered pinned if all rotations are free but one of the translations in the X, Y or Z directions is fixed or has a spring stiffness.

When a member is seen to have no restraint at an end the stiffness ratio G_a or G_b is taken as infinity at that end. This is based on the following commentary to C4.6.2.5 for column ends: "For column ends supported by but not rigidly connected to a footing or foundation, G is theoretically equal to infinity, but unless actually designed as a true frictionless pin, may be taken equal to 10 for practical design." Adopting this principle generally, for an unbraced frame member with $G = 10$ at both ends, the effective length factor is taken as 3.0.

Tee Section Slenderness

The commentary to section 6.12.2.2.4 notes that the flanges of all rolled tee sections given in AISC (2010) satisfy Eq. 6.10.2.2-1 of AASHTO 7th and therefore the limiting slenderness value for a noncompact flange λ_{rf} cannot be exceeded. The commentary

indicates that the check need only be applied to fabricated tee sections, although as noted earlier these are outside the scope of the design code checks. However in the design code checking this limiting value is implemented for all tee sections to deal with situations where the user may choose a tee section other than those defined in AISC (2010) or choose a material with a Young's modulus and/or strength different to that for US steel (these are required to determine the slenderness limits).

Where a flange local buckling check is required the commentary directs the user to AISC (2010). This check is implemented for the cases as described above. From AISC 360-10 the nominal flexural resistance is given by equation F9-7.

Channel Section Slenderness

Equations 6.12.2.2.5-10 to 6.12.2.2.5-13 set out the slenderness requirements for flanges and webs of fabricated or built-up channel sections. The commentary to section 6.12.2.2.5 notes that all rolled channels given in AISC (2010) have compact flanges and webs and therefore the slenderness checks are not required for rolled sections. However in the LUSAS design code checks these requirements are implemented for all channel sections to deal with situations where the user may choose a channel section other than those defined in ANSI / AISC 360-10 or choose a material with a Young's modulus and/or strength different to that for US steel (these are required to determine the slenderness limits).

References

A3 AISC Shapes Database Version 14.1, American Institute of Steel Construction, Chicago, October 2013

F5 FHWA-HIF-16-002 Steel Bridge Design Handbook, Federal Highways Administration, Washington DC, Dec 2015

S1 Lateral-Torsional Buckling of Wide Flange Cantilever Beams, B Dowswell, Proceedings of the 2002 Annual Stability Conference Structural Stability Research Council, 2002.

W1 Guide to Stability Design Criteria for Metal Structures, T V Galambos, Structural Stability Research Council, John Wiley and Sons, New York, 1998

Steel Frame Design Attribute Settings for AASHTO LRFD 8th (2017)

AASHTO LRFD 8th Edition (2017) steel frame design attributes can be defined by using the **Attributes > Design > Steel Frame Design** menu item after previously selecting that code from the **steel frame design code selection** dialog. After definition, steel frame design attributes need to be assigned to the appropriate lines in a model that represent steel members.

AASHTO LRFD 7th Edition Steel Frame Design

Section manufacture

Steel product standard: AASHTO M270M/M270
 Section fabrication: Rolled section
 Steel grade: Grade 36
 Edit...
 Welding process: Electric resistance welded

Axial

Ratio of net area to gross area: 0.6
 Reduction factor for shear lag U: 0.6
 Bolt hole type: Punched full size
 Member type in analysis: Primary
 Stress reversal: Possible

Compression

	Major axis	Minor axis	Torsion
Unbraced / buckling length from	Line	Line	Line
User defined length			
End conditions	c	c	
Design value of K	1.0	1.0	1.0

Flexure

Member type: All other cases
 Unbraced length from: Line
 User defined length:
 Bracing type top: Discretely braced
 Bracing type bottom: Discretely braced
 Sidesway in y direction: Unbraced
 Sidesway in z direction: Unbraced

Name: Des1 (new)

OK Cancel Apply Help

Section manufacture

- ❑ **Steel product standard** Supported standards are listed, as well as a User-defined option which permits defining Yield stress (F_y) and Tensile strength (F_u) for all components.
- ❑ **Section fabrication method** and **Steel grade** settings are required. For some fabrication methods (AASHTO built up only) a Hybrid section can be defined utilising different steel grades for the top and bottom webs and flange.
- ❑ **Edit** This button is only available for user-defined and hybrid settings.
- ❑ **Welding process** can be specified for cold or hot formed welded section fabrication methods (ASTM, not applicable to AASHTO).

Axial

- ❑ **Ratio of net area to gross area of cross section** A suitable value for the factor can be calculated. This is conservatively applied to the whole length of a member to allow for a reduction of gross area of cross-section as a result of holes or notches in members. It should be modified on a case-by-case basis.

- Reduction factor for shear lag** U A value from Table 6.8.2.2-1 of the code.
- Bolt hole type** Punched full size, or Drilled or sub-punched and reamed.
- Member type in analysis** selection is necessary to carry out the limiting slenderness ratio checks (section 6.8.4). The default option (primary member subject to possible stress reversals) results in the most onerous slenderness limit.

Shear

Shear calculations depend upon whether webs of members are stiffened or unstiffened. Design attributes are defined for each use by making a selection from the following:

- Unstiffened web** To be used to carry out a design check to 6.10.9.2. A single line can represent the member.
- Stiffened end web panel** To be used to carry out a design check to 6.10.9.3.3. Requires the length of the end web panel to be modelled by a single line in the model.
- Stiffened interior panel** To be used to carry out a design check to 6.10.9.3.2. Requires the interior web panel length to be defined.
 - **Interior web panel length** The common individual length of each interior web panel (the web stiffener spacing) for the region of the member being modelled.

A single meshed line can only be used to represent an unstiffened member. To model members with stiffened webs individual meshed lines must be defined to represent the length of each stiffened end web panel and the overall length of the stiffened interior web panels. Examples are shown below.

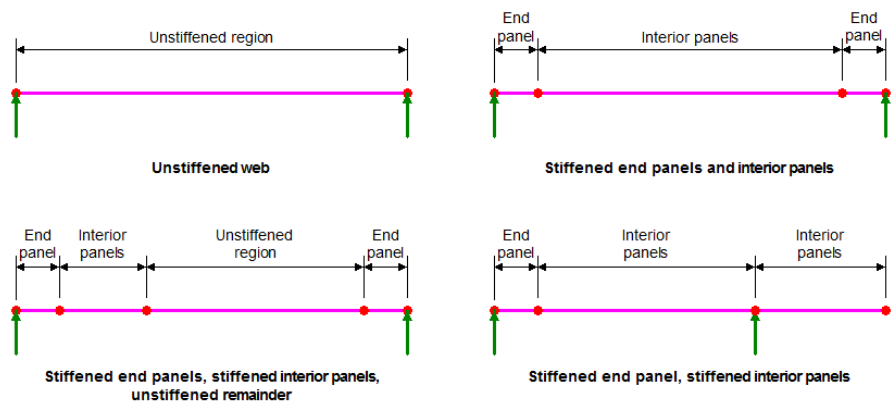

Examples of line beam modelling requirements to allow steel design shear checks for stiffened and unstiffened regions of members

If a single line is already representing the span of a member, and a design check implies that stiffeners are required, this is easily updated by selecting the line and splitting it into the required number of new lines by choosing **Geometry > Line > By splitting at distances** menu item. Any properties previously assigned to the original line will be applied to the new lines created, and appropriate steel design attributes can be assigned to the new lines created.

Notes

- For a member without web stiffeners only a single steel design attribute needs to be defined and assigned to the line representing that member in the model.
- For a member with stiffened web panels at least two steel design attributes need to be defined – one to be assigned to the line(s) representing that end web panel region(s) of the member, and one to be assigned to the line representing the region of the member that is stiffened. If a member also has an unstiffened region, a third steel design attribute would need to be defined and assigned to the line representing that region.
- Care must be taken to ensure that a stiffened web option is not assigned to a member consisting of a single line as the capacity of the end panels is not calculated and a bigger capacity than is intended will be calculated.

Angle section

- Connected leg of unequal angle** The leg of the angle, to which a connection is made to another member. Options are Short leg, Long leg or Both.
- Buckling length from** Derive a buckling length for calculations from a Line, Combined line, or a User defined length.
- User defined length** Specify a member buckling length in model units.

Compression buckling

- Unbraced / buckling length factors** When carrying out buckling checks the Design attribute applies factors to the member length to determine the buckling length about both the major and minor axes. A buckling length for torsional buckling must also be defined. Points of restraint can be different for each of the three buckling lengths and so the base length (unfactored) can be different in each case. The unbraced / buckling member length is derived from either a single line, or from a **combined line** (that represents a member that is defined by a series of lines). See [Defining Member Buckling Lengths](#) for more information. Alternatively, a **User defined length** can be specified for major axis, minor axis or torsional buckling.
- End conditions** These determine the effective length factor, K , as used in calculation of the elastic critical buckling resistance, P_e . The letters in the drop lists refer to those used in Table C4.6.2.5-1. Alternatively these factors can be manually input by selecting 'Other' as End conditions.

Flexural buckling

- Member type** is used to specify a member as either: 'Unbraced cantilever', or 'All other cases'.
- Unbraced length from** The unbraced / buckling member length is derived from either a single line, or from a **combined line** (that represents a member that is defined by a series of lines). See **Defining Member Buckling Lengths** for more information. Alternatively, a **User defined length** can be specified.
- Bracing type top** and **Bracing type bottom** requires a selection of either 'Discretely braced' or 'Continuously braced'.
- Sideway in y direction** and **Sideway in z direction** requires a selection of either 'Braced' or 'Unbraced'.

Name

- This defines the design attribute name that is created in the Attributes  Treeview ready for assignment to selected lines representing steel members in a model.

Summary of steel frame design checks made to AASHTO LRFD 8th Edition

Assignment of AASHTO LRFD 8th steel frame design attributes to lines representing steel members permits the following design checks to be carried out on the member cross-section (with reference to clauses from the design code):

- Tension (article 6.8.2)
- Compression (article 6.9.2)
- Flexure about major axis including lateral torsional buckling check (articles 6.10.8 and 6.12.2.2)
- Flexure about minor axis (article 6.12.2.2)
- Shear (articles 6.10.9 and 6.12.1.2.3)
- Tension and flexure (article 6.8.2.3)
- Compression and flexure (article 6.9.2.2)
- A summary “check” with the largest utilisation from all other design checks

Design checks are currently carried out for the following section profiles:

- Rolled and fabricated doubly symmetric I-sections / H-sections with constant thickness flanges

- Fabricated singly symmetric I-sections /H-sections with constant thickness flanges
- Rolled channel sections with sloped flanges
- Rolled angles with legs of equal thickness and with a leg ratio of less than 1.7
- Rolled Tee sections with sloped and constant thickness flanges
- Hot formed and cold formed round HSS
- Hot formed and cold formed rectangular HSS

General Notes

- The current implementation is limited to the general requirements of AASHTO 8th. Appendix A6 is not implemented.
- The Service Limit State (article 6.10.4) is not considered.
- Constructability requirements for I-sections (article 6.10.3) are currently not considered.

Implementation Notes

- See [Implementation Notes for Steel Frame Design Checks to AASHTO LRFD 8th \(2017\)](#) for more information

Implementation Notes for Steel Frame Design Checks to AASHTO LRFD 8th (2017)

References cited are provided at the foot of this topic.

Local Axes

In AASHTO the local axis along a member is taken in the z direction, while the cross section axes are taken as x and y. As this is not consistent with the naming convention used within LUSAS Modeller all parameters in AASHTO 8th with reference to a local axis are modified appropriately in the rendered calculations. The following summarises the modifications:

AASHTO 8th notation Modeller & rendered notation

x-axis	y-axis
y-axis	z-axis
z-axis	x-axis

It should also be noted for channel sections that AASHTO takes the axis of symmetry as the y-axis (which is modified in LUSAS Modeller to be the z-axis).

Hollow sections from the AISC 14 and ASTM A1085 product standards

In accordance with article 6.12.2.2 hollow sections defined in the geometric attribute library to AISC 14 have a reduction factor (with a value of 0.93) applied to the thickness and in the calculation of section properties. However, as implemented, this reduction factor will also be applied when a steel design check is carried out, when it should not be applied. As a result conservative results will be obtained. The exception to this, is when sections from the ASTM A1085 product standard are used, when no additional reduction factor will be applied.

Design Checks for Compression

When calculating 'Aeff' for a round HSS, a value of $A_{eff} > A_y$ can be obtained due to rounding effects. An upper limiting value of 1.0 is applied to resolve this issue.

Flexure

- ❑ **Sign convention in flexure** Different sign conventions for tensile and compressive stresses due to flexure are used in LUSAS Modeller from AASHTO. The convention in Modeller is adopted to maintain consistency within the software. However occasionally situations arise where maintaining the Modeller sign convention is not practical as it would lead to a re-interpretation of equations as provided in AASHTO 8th. An example of this is the calculation of C_b values of I-sections. In these situations the relevant stresses are factored by -1.
- ❑ **Maximum compression flange stress in web bend-buckling resistance** When calculating the Web bend-buckling resistance, the commentary (C6.10.1.9.1) notes that "resistance is checked generally against the maximum compression-flange stress due to factored loads". In this context maximum compression flange stress is taken to apply to the maximum value in the depth of the section and not the maximum along the length of the member.
- ❑ **Rectangular HSS** The nominal flexural resistance for lateral torsional buckling is given by equation 6.12.2.2-1. While lateral torsional buckling does not apply to the weak axis the check is carried out to both axes. This is to accommodate sections defined using the section property calculator where $B > D$, in which case the y-y axis is the weak axis. The effective section modulus is determined using the conservative approach noted in C6.12.2.2 whereby the effective width is applied to the tension flange as well as the compression flange. The section modulus is then determined from first principles.

Lateral Torsional Buckling

The commentary to 6.10.1.6 notes that the use of coincident values of f_l , f_{bu} and μ can be used although the use of maximum values in an unbraced length will give

conservative results. In applying the LUSAS design check calculations, the coincident effects are used.

- ❑ **Moment gradient modifier, C_b** For a given cross-section C_b is assessed for the compression flange. Therefore where a member is bent in double curvature there will be two values of C_b – one for each flange. The Commentary in C6.10.8.2.3 notes that the calculations provided to determine C_b neglect the effect of the location of the applied load relative to the mid-height of the section. The user is directed to two publications – Galambos [W1] and Dowswell [S1] – for methods on how to deal with different situations. These situations are outside the scope of the current design checks.
- ❑ **Warping torsional constant, C_w** The design checks for lateral torsional buckling of channel sections uses the values of C_w as calculated by LUSAS Modeller rather than the value in equation 6.12.2.2.5-6 of AASHTO 8th.

Design Checks for Shear

- ❑ **Shear in y and z directions** The following shear checks are explicitly considered in AASHTO:
 - Shear in the webs of I-sections (F_z effects) for both doubly symmetric and singly symmetric sections – from clause 6.10.9
 - Shear in flanges of I-sections (F_y effects) – from clause 6.12.1.2.3a
 - Shear in stems of tee section (F_z effects) – from clause 6.12.1.2.3a
 - Shear in web of rectangular HSS (F_y and F_z effects) – from clause 6.12.1.2.3b
 - Circular tubes including round HSS – from clause 6.12.1.2.3c. The same check is applied to F_y and F_z effects.

AISC 360-10 applies the same method to webs of channels as for webs of I sections which is practically identical to that for I-sections in AASHTO (there are some minor adjustments to the ratio of shear-buckling resistance to shear yield strength). This method is therefore adopted for F_z to channel sections.

Section G7 of AISC 360-10 deals with weak axis shear to doubly symmetric (standard I-sections) and singly symmetric shapes and is the same as the requirements clause 6.12.1.2.3a of AASHTO 7th. This method is therefore applied to the flanges of channels.

- ❑ **Specified minimum yield strength of web** Calculation of the plastic shear force, V_p , as given by equation 6.10.9.2-2 is dependent upon the specified minimum yield strength of the web, F_{yw} . The ratio of the shear buckling resistance to the shear yield strength, C , is also dependent upon F_{yw} . For rolled sections, F_{yw} is taken as the specified minimum yield strength. For a hybrid section with loads parallel to the web the specified minimum yield strength of the web is used. However for the case of a hybrid section with loads parallel to

the flange the strength of each flange is considered separately. In this case the term F_{yw} is replaced with $F_{yf,top}$ and $F_{yf,bot}$ as appropriate. This nomenclature differs from AASHTO 8th, which only makes reference to F_{yw} .

- ❑ **Parameter D when calculating nominal shear resistance** For open sections, the value of D is taken as the distance between flanges. In the case of tee sections D is taken as the distance from the tip of the stem to the underside of the flange.
- ❑ **Shear resistance of rectangular HSS** When considering shear in a rectangular HSS, an element resisting shear is referred to as a web. Therefore in a RHS member resisting shear from both the y and z directions, the long sides will be referred to as webs when considering shear in the z direction and the short sides will be referred to as webs when considering shear in the y direction.
- ❑ **Shear resistance of round HSS and parameter L_v** L_v is taken as the longer distance from the point of zero shear to the end of the beam. This approach may result in values of L_v being adopted which do not match description in AASHTO (distance between points of maximum and zero shear), although the results are conservative.

Angles

Calculation of A_{eff} for cross-sections composed of slender elements requires a reduction in the cross section area to account for the slender elements. Using the limiting values of width-to-thickness ratios given in Table 6.9.4.2.1-1 determines whether or not a section is slender. However, whilst for the case of angles a limiting value is given for the ‘Outstanding Legs of Single Angles’, no limiting value is given for the connected leg – implying that the connected leg, if slender, should not be included in the calculation of A_{eff} . This is different from AISC 360-16 where there is no differentiation made between the outstanding leg and the connected leg – the description is simply ‘Leg of single angles’. Since this is conservative this approach is adopted in the AASHTO 8th implementation.

Biaxial Bending Checks

There is no explicit check for biaxial bending in AASHTO 8th. However sections 6.8.2.3 and 6.9.2.2 consider biaxial bending in conjunction with axial tension and axial compression respectively. For members with no axial load, these checks are applied even though they are part of the Tension Members section and Compression Members section respectively.

Bending about the z-axis is outside the scope of the design checks for tee sections and therefore biaxial bending checks are outside the scope of the checks. However the combined effects of bending about the y-axis and tension / compression are checked but this requires equations 6.8.2.3-1 and 6.8.2.3-2 or 6.9.2.2-1 and 6.9.2.2-2 to be modified by omitting the M_{uz}/M_{rz} part as appropriate.

Combined Axial Compression and Flexure

For nonslender elements 6.9.4.2.1-2 is adopted for the combined axial compression and flexure check.

As implemented, for all other cases when carrying out the combined axial compression and flexure check, clause 6.9.2.2 allows the values of the factored flexural moments about the y-axis and z-axis to be determined by either:

- A second order elastic analysis that accounts for the magnification of moment caused by factored axial load
- The approximate single step adjustment specified in Article 4.5.3.2.2b

The design checks assume that a first order linear elastic analysis has been carried out and so the single step adjustment is applied to the bending moments. The method is simplified such that the larger value of δ_b and δ_s is assigned to the total moment on the compression member. The value of C_m used in equation 4.5.3.2.2b-3 is conservatively taken as 1.0 in all cases. When determining the moment magnification the calculation of δ_s is based on individual columns i.e. they are assumed not to be connected integrally to the same superstructure as described in 4.5.3.2.2b.

Effective length factor, K

The choice of End conditions on the Steel Design Attribute dialog is used to determine the effective length factors used in calculation of the elastic critical buckling resistance, P_e . The letters in the drop lists refer to those used in Table C4.6.2.5-1 and can be summarised as follows:

End condition selected in Modeller	Design K value	End conditions to be considered
a	0.65	Rotation fixed and translation fixed at both ends
b	0.80	Rotation fixed and translation fixed at one end, rotation free and translation fixed at other end
c	1.00	Rotation free and translation fixed at both ends
d	1.20	Rotation fixed and translation fixed at one end, rotation fixed and translation free at other end
e	2.10	Rotation fixed and translation fixed at one end, rotation free and translation free at other end
f	2.00	Rotation free and translation fixed at one end, rotation fixed and translation free at other end

For combined axial compression and flexure the effective length factor, K, is required for braced frame and unbraced frame conditions in calculating P_e . The K values are determined using the method set out in the commentary of AASHTO 8th and equations C4.6.2.5-4, C4.6.2.5-5 and C4.6.2.5-6 as appropriate. In applying these equations the stiffness of members connected to each end of the member under

consideration must be considered in the local y and z planes. The effect of out of plane members connected at the end of a member is ignored.

Where a support is provided at the end of a member the stiffness ratio G_a or G_b is taken as 1.0 for a rigid end condition and 10 for a pinned end. A support is considered as rigid if any one of the rotations in the X, Y or Z directions is fixed or has a spring stiffness. A support is considered pinned if all rotations are free but one of the translations in the X, Y or Z directions is fixed or has a spring stiffness.

When a member is seen to have no restraint at an end the stiffness ratio G_a or G_b is taken as infinity at that end. This is based on the following commentary to C4.6.2.5 for column ends: "For column ends supported by but not rigidly connected to a footing or foundation, G is theoretically equal to infinity, but unless actually designed as a true frictionless pin, may be taken equal to 10 for practical design." Adopting this principle generally, for an unbraced frame member with $G = 10$ at both ends, the effective length factor is taken as 3.0.

Tee Section Slenderness

The commentary to section 6.12.2.2.4 notes that the flanges of all rolled tee sections given in AISC (2016) satisfy Eq. 6.10.2.2-1 of AASHTO 8th and therefore the limiting slenderness value for a noncompact flange λ_{rf} cannot be exceeded. The commentary indicates that the check need only be applied to fabricated tee sections, although as noted earlier these are outside the scope of the design code checks. However in the design code checking this limiting value is implemented for all tee sections to deal with situations where the user may choose a tee section other than those defined in AISC (2016) or choose a material with a Young's modulus and/or strength different to that for US steel (these are required to determine the slenderness limits).

Where a flange local buckling check is required the commentary directs the user to AISC (2016). This check is implemented for the cases as described above. From AISC 360-10 the nominal flexural resistance is given by equation F9-7.

Channel Section Slenderness

Equations 6.12.2.2.5-10 to 6.12.2.2.5-13 set out the slenderness requirements for flanges and webs of fabricated or built-up channel sections. The commentary to section 6.12.2.2.5 notes that all rolled channels given in AISC (2010) have compact flanges and webs and therefore the slenderness checks are not required for rolled sections. However in the LUSAS design code checks these requirements are implemented for all channel sections to deal with situations where the user may choose a channel section other than those defined in ANSI / AISC 360-2016 or choose a material with a Young's modulus and/or strength different to that for US steel (these are required to determine the slenderness limits).

References

A3 AISC Shapes Database Version 14.1, American Institute of Steel Construction, Chicago, October 2013

F5 FHWA-HIF-16-002 Steel Bridge Design Handbook, Federal Highways Administration, Washington DC, Dec 2015

S1 Lateral-Torsional Buckling of Wide Flange Cantilever Beams, B Dowswell, Proceedings of the 2002 Annual Stability Conference Structural Stability Research Council, 2002.

W1 Guide to Stability Design Criteria for Metal Structures, T V Galambos, Structural Stability Research Council, John Wiley and Sons, New York, 1998

Steel Frame Design Attribute Settings for AS4100

AS4100 steel frame design attributes can be defined by using the **Attributes > Design > Steel Frame Design** menu item after previously selecting that code from the **steel frame design code** selection dialog. After definition, steel frame design attributes need to be assigned to the appropriate lines in a model that represent steel members.

AS4100 Steel Frame Design

Section manufacture
Steel product standard: AS/NZS 3679.1 Stru
Steel grade: 400
Section fabrication: Hot Rolled
Residual stresses: HR - hot rolled or hot

User-defined material
Yield stress f_y :
Tensile strength f_u :

Axial (tension)
Ratio of net area to gross area (A_n/A_g): 0.6
The correction factor for distribution of forces k_t (clause 7.3): 1.0

General buckling

Major axis
Buckling length from: Line
Define end restraints: Rotation free, translation fixed
Length factor (key): 1.0
 β_{my} (clause 4.4.2.2) Auto

Minor axis
Buckling length from: Line
Define end restraints: Rotation free, translation fixed
Length factor (kez): 1.0
 β_{mz} (clause 4.4.2.2) Auto

Torsion
Buckling length from: Line
Length factor (kex): 1.0
kez = $k_t \cdot k_d \cdot k_r$ (for Out of Plane Capacity)

Lateral torsional buckling
End restraints: PP - partially restrained / partial
Load height: Top Flange
 Twist restraint factor k_t Auto
 Moment modification factor α_m Auto
 Load height factor k_l Auto
 Lateral rotation restraint factor k_r Auto

Name: Des1 (new)

OK Cancel Apply Help

Section manufacture

- Steel product standard** Supported standards are listed, as well as a User-defined option which permits defining Yield stress and Tensile strength values to specify a steel grade.
- Steel grade** Selected for a specified steel product standard.

- Section fabrication** Selected for a specified steel product standard.
- Residual stresses** provides the means to choose Stress relieved, or Hot rolled or hot finished

User-defined material

- Yield stress** can be defined by choosing User defined as a Steel product standard.
- Tensile strength** can be defined by choosing User defined as a Steel product standard.

Axial (tension)

- Ratio of net area to gross area (A_n/A_g)** A suitable value for the factor can be calculated. This is conservatively applied to the whole length of a member to allow for a reduction cross-section gross area as a result of holes or notches in members. It should be modified on a case-by-case basis.
- The correction factor for distribution of forces k_t Clause 7.3** A suitable factor in accordance with the clause stated.

General buckling

- Calculation of buckling length** When carrying out buckling checks the Design Attribute applies factors to the member length to determine the buckling length about both the major and minor axes. A buckling length for torsional buckling must also be defined. Points of restraint can be different for each of the three buckling lengths and so the unrestrained length (unfactored) can be different in each case. To accommodate this, the base length is determined from the parent length of a line or the member length of a **combined line**. This requires the user to be aware that members should not be made up of a series of lines where there are no intermediate points of restraint at the end points of each line. See [Defining Member Buckling Lengths](#) for more information.
- End restraint conditions** for axial buckling can be chosen from six possible combinations, and be specified independently for the major axis and the minor axis. There is also the option 'Length factor' to override the given combination and input the effective length factor (k_e) manually.
- Beta m factors** Beta m_y and Beta m_z factors are conservatively taken as -1. Alternatively they can be user-defined.

Lateral torsional buckling information

- End restraints** Compression flange restraint arrangement can be specified as Continuous restraint or as any permutation of fully / partially / laterally restrained, and also unrestrained at one end.
- Load height** Top flange or Shear centre. The load height factor is conservatively applied to all loads.
- Twist restraint factor** (set to auto) - can be optionally user-defined
- Load height factor** (set to auto) - can be optionally user-defined. This value is applied to all loadcases.

- Moment modification factor** (set to auto) - can be optionally user-defined
- Lateral rotation restraint factor** (set to auto) - can be optionally user-defined

Summary of steel design checks made to AS4100

Assignment of AS4100 steel frame design attributes to lines representing steel members permits the following design checks to be carried out on the member cross-section (with reference to clauses from the design code):

- 7.1 Tension
- 6.2 Compression, Section Capacity
- 6.3 Compression buckling in the z-z axis
- 6.3 Compression buckling in the y-y axis
- 5.2 Bending about y-y axis, Section Capacity
- 5.2 Bending about z-z axis, Section Capacity
- 5.6 Bending about y-y axis, Member Capacity (LTB)
- 5.11 Shear for loads parallel to z-z axis
- 5.11 Shear for loads parallel to y-y axis
- 5.12.3 Interaction of Shear and Bending, for loads parallel to z-z axis
- 5.12.3 Interaction of Shear and Bending, for loads parallel to y-y axis
- 8.3 Bending and Axial, Section Capacity
- 8.4 Bending and Axial, Member Capacity, Elastic Analysis
- A summary "check" with the largest utilisation from all other design checks.

Design checks are currently carried out for the following section profiles:

- Doubly and Mono symmetric I-sections
- Channel sections
- Rectangular and Circular hollow sections of constant wall thickness
- Solid Circular sections
- Sections can be rolled or fabricated.
- Angles

General notes

- Design calculations for tension (7.1) require checks to be carried out based on the net area (reduced due to fasteners). In order to determine the net area and the effective net area ratios (ratio of net area to gross area) need to be assigned. Note that the net area is conservatively applied to the whole length of the member.
- When carrying out lateral torsional buckling checks the steel frame design attribute applies restraint conditions. One of these conditions is continuous restraint. This restraint is applied to the whole section irrespective of which flange is in compression.
- For rectangular hollow sections lateral torsional buckling checks are only carried out where the depth is greater than the breadth. An error is returned for cases where there is M_z bending and the breadth is greater than the depth.
- Axial buckling and lateral torsional buckling checks are not supported for tapered and stepped beams.
- Lateral torsional buckling checks for cantilevers are currently outside the scope of the design checks.
- Design checks for angle sections are limited to $Util(Fx_t)$ - utilisation for tension, $Util(Fx_c)$ - utilisation for compression, $Util(Fx)_{c,by}$ - utilisation for compression member about the y-axis, and $Util(Fx)_{c,bz}$ - utilisation for compression member about the z-axis.

Implementation Notes

- See [Implementation Notes for Steel Frame Design Checks to AS4100](#) for more information.

Implementation Notes for Steel Frame Design Checks to AS 4100

Local Axes

In AS 4100 the local axis along a member is taken in the z direction, while the cross section axes are taken as x and y. As this is not consistent with the naming convention used within LUSAS Modeller, all parameters in AS 4100 with reference to a local axis are modified appropriately in the rendered calculations. The following summarises the modifications:

AS 4100 notation Modeller & rendered notation

x-axis	y-axis
y-axis	z-axis
z-axis	x-axis

Load tolerance

A stress less than 0.1% of f_y is considered negligible. This determines if particular design checks (e.g. axial compression, bending moment about minor axis, etc.) are required.

Beta m factor, Clause 4.4.2.2

The “ β_m ” factor is always taken as “-1”.

Shear and Bending and Shear in the minor axis checks

Shear checks in the minor axis direction are only carried out for hollow sections and solid circular sections.

Load Height Factor, kl

The option to specify the longitudinal position of the load has not been implemented. The load height factor “kl” (Table 5.6.3(3)) can be specified manually in the design attribute. It should be noted with the user-defined option that the value of kl will be adopted for all loadcases. The load height factor is conservatively applied to all loads.

Lateral rotation restraint factor, kr

The lateral rotation restraint factor, k_r , (Table 5.6.3(3)) has been conservatively taken as 1.0 in all cases.

Nominal out-of-plane member moment capacity

The equation in section 8.4.4.2 is written as $M_{bx}(1 + N/\Phi_t) \leq M_{rx}$ is incomplete. This has been interpreted as $M_{bx}(1 + N/N_t\Phi_t) \leq M_{rx}$

Moment modification factor α_m

The moment modification factor α_m for segments of constant cross section from Clause 5.6.1.1 is implemented using method ‘iii’.

Steel Frame Design Attribute Settings for CSA-S6-14

CSA-S6-14 steel frame design attributes can be defined by using the **Attributes> Design> Steel Frame Design** menu item after previously selecting that code from the [steel frame design code selection](#) dialog. After definition, steel frame design attributes need to be assigned to the appropriate lines in a model that represent steel members.

CSA-56-14 Design attributes

Material properties

Section manufacture User-defined material

Steel grade: 300W Yield stress Fy: _____

Section fabrication: Rolled shapes or Tensile stress Fu: _____

Shear

Transverse stiffeners are provided in accordance with 10.10.6

Spacing of transverse stiffeners (a): _____

Tension

Ratio of net area to gross area (An/A): 0.8 Length of the tension element: _____

Ratio of effective net area to gross area (Ane/A): 0.6 Length from: Combined line

Maximum slenderness ratio for tensioned members (10.8.1.2): 160 User-defined length: _____

Compression

Major axis

Buckling length from: Combined line

User-defined length: _____

Define length factor: 1

Minor axis

Buckling length from: Combined line

User-defined length: _____

Define length factor: 1

Torsion

Buckling length from: Combined line

User-defined length: _____

Define length factor: 1

Coefficient for axial buckling resistance (n) (10.9.3): 1.34 Maximum slenderness ratio for compression members (10.9.1.3): 120

Laterally unbraced members (C10.10.2.3)

Top flange

Buckling length from: Combined line

Define length factor: 1

Bottom flange

Buckling length from: Combined line

Define length factor: 1

Parameter that allows for the destabilising or stabilising effects of loads applied to the beam between restraints (C2): 0

Distance from the shear centre to the point of application of transverse load (g) (g is positive for loads acting towards the shear centre from their point of application): 0

Parameter that accounts for the shape of the bending moment (C3): 1

Axial compression and bending

Member in braced frames

Name: Des3 (new)

OK Cancel Apply Help

Material properties

Section manufacture

- Steel grade
- Section fabrication

User-defined material

- Yield stress Fy
- Tensile stress Fu

Shear parameters

- Transverse stiffeners are provided in accordance with 10.10.6
- Spacing of transverse stiffeners (a)

Tension parameters

- Ratio of net area to gross area (A_n/A) to account for deductions for fastener holes made by punching. (10.8.2)**
- Ratio of effective net area to gross area (A_{ne}/A) to account for deductions due to both fastener holes and shear lag effects (10.8.2)**
- Maximum slenderness ratio for tensioned members (10.8.1.2)**
- Length of the tension element** - Combined line / line or a user-defined length. The base length is determined from the parent length of a line or the member length of a combined line (that represents a member that is defined by a series of lines). Alternatively, the length can be manually input by the user. See [Defining Member Buckling Lengths](#) for more details.

Compression parameters

- Buckling length** (defined separately for: major axis, minor axis and torsion) with options of Combined line / line or a user-defined length
- Define length factor** (defined separately for: major axis, minor axis and torsion), taken as the effective length factor based on the rotational and translational restraint afforded at the ends of the unbraced length. A user-defined option factor can alternatively be specified.
- Coefficient for axial buckling resistance (n) (10.9.3.1)**
- Maximum slenderness ratio for compression members (10.9.1.3)

Bending parameters

- Laterally unbraced frames** Select whether the member is considered to be laterally unbraced in accordance with (Commentary on CSA-S6-06. C10.10.2.3)
- Buckling length** (defined separately for top flange and bottom flange) with options of Combined line / line or a user defined length - see [Member Buckling Lengths](#) for more details.
- Define length factor** (defined separately for: major axis, minor axis), taken as the effective length factor based on the rotational and translational restraint afforded at the ends of the unbraced length.
- Parameter that allows for the destabilising or stabilising effects of loads applied to the beam between restraints (C2) (C10.10.2.3)**
- Distance from the shear centre to the point of application of transverse load (g) (C10.10.2.3)**
- Parameter that accounts for the shape of the bending moment (C3) (C10.10.2.3)**

Axial compression and bending parameter

- Member in braced frames.** When this option is selected, conditions a, b and c will be checked. Otherwise only conditions b and c are checked. (C10.9.4.1)

Name

- Defines the design attribute entry that is created in the Attributes  Treeview ready for assignment to selected lines representing steel members in a model.

Summary of steel frame design checks made to CSA-S6-14

Assignment of CSA S6-14 steel frame design attributes to lines representing steel members permits the following design checks to be carried out on the member cross-section (with reference to clauses from the design code - and when particular cross-sections are supported by clause of the design code):

- Tension (10.8)
 - Axial tension (10.8.2)
 - Axial tension and bending (10.8.3)
- Compression (10.9)
 - Axial Compression (10.9.3)
 - Axial compression and bending (10.9.4)
- Shear (10.10.5)
 - Shear for loads parallel to depth (10.10.5.1)
 - Combined shear and moment (10.10.5.2)
- Bending moment about minor axis (10.10.2.4, 10.10.3.5)
- Bending moment about major axis (10.10.2.2, 10.10.3.2) - Laterally supported member
- Bending moment about major axis (C10.10.2.3 and commentary, 10.10.3.3) - Laterally unbraced member
- Design summary “check” with the largest utilisation from all other design checks.

Design checks are currently carried out for the following section profiles:

- Doubly symmetric I-sections
- Singly symmetric I-sections
- C-sections
- L-sections
- T-sections,
- Square, rectangular and circular hollow sections of constant wall thickness

General Notes

- Checks on torsion (10.21) are currently not included.
- Sections are checked for classification but class 4 are not currently designed.

Implementation Notes

- See [Implementation Notes for Steel Frame Design Checks to CSA S6-14](#) for more information.

Implementation Notes for Steel Frame Design Checks to CAN/CSA-S6-14

References cited are provided at the foot of this topic

Local Axes

In CAN/CSA-S6-14 the local axis along a member is taken in the z direction, while the cross section axes are taken as x and y. As this is not consistent with the naming convention used within LUSAS Modeller all parameters in CAN/CSA-S6-14 with reference to a local axis are modified appropriately in the rendered calculations. The following summarises the modifications:

<u>CAN/CSA-S6-14 notation Modeller & rendered notation</u>	
x-axis	y-axis
y-axis	z-axis
z-axis	x-axis

It should also be noted for channel sections that CAN/CSA-S6-14 takes the axis of symmetry as the y-axis (which is modified in LUSAS Modeller to be the z-axis).

Section Classification

Section 10.9.2 of [C1] sets out the classification procedures for cross-sections. Design calculations can be carried out for Class 1, 2 and 3 sections. However Class 4 sections cannot currently be considered, as “effective” section properties need to be considered. The “effective” section allows for “non effective zones” which alter the section properties and involves rather complex calculations.

When considering the classification of welded sections the length of the element under consideration should neglect the weld leg length. However leg length is currently undefined and so this requirement is conservatively ignored.

Tension Check - net area and effective net area

Design calculations for tension (Section 10.8 of [C1]) require checks to be carried out based on the net area (reduced due to fasteners) and the effective net area (reduced due to fasteners and shear lag). In order to determine the net area and the effective net area the user is required to assign ratios (ratio of net area to gross area and ratio of effective net area to gross area). Note that the net area and effective net area are conservatively applied to the whole length of the member.

Shear Areas

Design calculations for shear are carried out using the shear areas given in Clause 10.10.5 [C1]. The shear areas provided are for I cross-sections only. This approach has been used for Channel, Tee and Rectangular hollow sections.

Lateral Torsional Buckling Check

The method to calculate critical elastic moment given in Clause 10.10.2.3 of [C1] has limited use. The LUSAS design checks use the general expression for the critical elastic moment specified in Clause C10.10.2.3 of [C2]. The expression in [C2] is an extension of the expression in [C1].

Load tolerance

Effects causing a stress less than 0.001MPa are considered as negligible. This is used to determine if particular design checks (e.g. axial compression, bending moment about minor axis) are required.

References

C1 CAN/CSA-S6-14 Canadian Highway Bridge Design Code

C2 CAN/S6.1-06 Commentary on CAN/CSA-S6-06 Canadian Highway Bridge Design Code

Steel Frame Design Attribute Settings for EN1993-1-1 and EN1993-2

EN1993-1-1 and EN1993-2 steel frame design attributes can be defined by using the **Attributes> Design> Steel Frame Design** menu item after previously selecting the relevant code from the **steel frame design code selection** dialog. After definition, steel frame design attributes needs to be assigned to the appropriate lines in a model that represent steel members.

The screenshot shows the 'EN1993-1-1 / EN1993-2 Steel Frame Design' dialog box. It is divided into several sections:

- Section manufacture:** Includes dropdowns for 'Steel product standard' (EN 10025-2), 'Steel grade' (S 235), and 'Section fabrication' (Hot rolled section). There is an 'Edit user defined...' button.
- Axial (tension):** Contains a text input for 'Ratio of net area to gross area' (0.6).
- Angle section:** Includes a checkbox for 'Angle section', dropdowns for 'Buckling length from' (Line) and 'Angle connection is' (Welded), and radio buttons for 'Bolts to connection' (One bolt, Two bolts, Three or more bolts). It also has text inputs for 'User defined system length', 'Bolt hole diameter', 'Bolt pitch', and 'Bolt edge distance'.
- Shear:** Includes a checkbox for 'Transverse stiffeners provided', a text input for 'Transverse stiffener spacing', and radio buttons for 'End posts' (No end post, Rigid end post, Non-rigid end post).
- Bending:** Includes dropdowns for 'Restraint to flanges' (No restraint) and 'Buckling length from' (Line), and text inputs for 'User defined length' and 'Define length factor' (1.0).
- Compression:** Divided into three sub-sections:
 - Major axis:** Buckling length from (Line), User defined length, Define end restraints (radio button), End 1 (Held in position / Not restr), End 2 (Held in position / Not restr), Define length factor (radio button), and Define length factor (1.0).
 - Minor axis:** Buckling length from (Line), User defined length, Define end restraints (radio button), End 1 (Held in position / Not restr), End 2 (Held in position / Not restr), Define length factor (radio button), and Define length factor (1.0).
 - Torsion:** Buckling length from (Line), User defined length, and Define length factor (1.0).

At the bottom, there is a 'Name' field with 'Des3' and a '(new)' indicator, and buttons for 'OK', 'Cancel', 'Apply', and 'Help'.

Section manufacture

- Steel product standard** Supported standards are listed, as well as a User-defined option which permits defining a variety of values to specify a steel grade.
- Steel grade** Selected for a specified steel product standard.
- Section fabrication** Selected for a specified steel product standard.
- Edit user-defined** provides the means to change user-defined steel grade parameters. Buckling curve options are in accordance with Table 6.2.

Axial (tension)

- Ratio of net area to gross area** A suitable value for the factor can be calculated. This is conservatively applied to the whole length of a member to allow for a reduction of gross area of cross-section as a result of holes or notches in members. It should be modified on a case-by-case basis.

Angle section

- Buckling length from** Specify Line, Combined line or a User-defined system length. See *Notes on buckling checks* below.
- Angle connection is** Specify Welded, Bolts to both legs, Bolts to long leg, or Bolts to short leg. For bolts to long or short legs the **bolt hole diameter** and **bolt edge distance** must be stated.
- Bolts to connection** Specify One, Two or Three or more bolts. For two, or three or more bolts the **bolt pitch** must be stated

Shear

Shear options are disabled if a product standard for hollow sections or a user-defined hot finished or cold formed welded hollow section is specified.

- Transverse stiffeners** Specify if transverse stiffeners are provided, and if so, specify the transverse stiffener spacing. Transverse stiffeners can only be applied at a fixed spacing in each design attribute defined. The presence of transverse stiffeners is only considered for doubly symmetric I-sections.
- End posts** Specify type of end post as None, Rigid or Non-rigid.

Bending

- Restraint to flanges** Specify the restraint to flanges as either No restraint, Top flange restrained, Bottom flange restrained, or Both flanges restrained.
- Buckling length from** Specify Line, Combined line or a **User-defined length**. See *Notes on buckling checks* below.
- Define length factor** Buckling length factors are automatically determined for a number of predefined end conditions. The calculated factors are based on values specified in BS 5950, for the following generic end conditions: Held/Not held in position refer to the ability to move translationally, and Restrained/Partially restrained/Not restrained in direction refer to the ability to rotate. Alternatively, the buckling length factors can be user-defined.

Compression

- Buckling length from** Specify Line, Combined line or a **User-defined length**. See *Notes on buckling checks* below.
- Define end restraints** Specify the restraints as either 'Held in position / Restrained in direction', or 'Held in position / Partially restrained in direction', or 'Held in position / Not restrained in direction'. Held / Not held in position refer to the ability to move translationally, and Restrained / Partially restrained / Not restrained in direction refer to the ability to rotate. Buckling length factors are automatically determined for these predefined end conditions. The calculated factors are based on values specified in BS 5950.
- Define length factor** The buckling length factors can be user-defined.

Name

- This defines the design attribute entry that is created in the Attributes  Treeview ready for assignment to selected lines representing steel members in a model.

Notes on buckling checks

When carrying out buckling checks the steel frame design attribute applies factors to the member length to determine the buckling length about both the major and minor axes. A buckling length for torsional buckling must also be defined. Points of restraint can be different for each of the three buckling lengths and so the base length (unfactored) can be different in each case. To accommodate this, the base length is determined from the parent length of a line or the member length of a **combined line** (that represents a member that is defined by a series of lines). See **Defining Member Buckling Lengths** for more information.

When a user defined length is used for lateral torsional buckling the coefficient for moment distribution, C_1 , when calculating the elastic critical moment is taken as 1.0. Similarly the equivalent uniform moment factors, C_m , from Table B.3 are taken as 1.0 for each case.

Summary of Steel Frame Design Checks made to EN1993-1-1 and EN1993-2

Assignment of EN1993-1-1 and EN1993-2 steel frame design attributes to lines representing steel members permits the following design checks to be carried out on the member cross-section (with reference to clauses applicable to both design codes except where stated):

EN1993-1-1

- 6.2.3 Tension
- 6.2.4 Compression
- 6.2.5 Bending Moment (for both principal axes)
- 6.2.6 Shear (for both principal axes)
- 6.2.8 Bending and shear (for both principal axes)
- 6.2.9 Bending and axial force
- 6.2.10 Bending, shear and

EN1993-2

- 6.2.3 Tension
- 6.2.4 Compression
- 6.2.5 Bending Moment (for both principal axes)
- 6.2.6 Shear (for both principal axes)
- 6.2.9 Bending and shear (for both principal axes)
- 6.2.10 Bending and axial force
- 6.2.11 Bending, shear and axial force (this is effectively dealt with in 6.2.10) -

axial force (this is effectively dealt with in 6.2.9) for EN1993-2.

Design checks carried out for buckling resistance for both EN1993-1-1 and EN1993-2 include:

- 6.3.1 Uniform members in compression
- 6.3.2 Uniform members in bending
- 6.3.3 Uniform members in bending and axial compression
- A design summary “check” with the largest utilisation from all other design checks

Design checks are currently carried out for the following section profiles for both EN1993-1-1 and EN1993-2:

- Doubly symmetric I-sections
- Doubly symmetric H-sections
- Square, rectangular and circular hollow sections of constant wall thickness.
- Class 3 Angles

General Notes

- The effect of warping resistance is considered in all sections.
- Checks on torsion (6.2.7) are not currently included.
- For EN1993-1 the modification of shear capacity in sections (6.2.8 and 6.2.10) to account for the effects of torsion when considering combined effects has not yet been implemented.
- For EN1993-2 the modification of shear capacity in sections (6.2.9 and 6.2.11) to account for the effects of torsion when considering combined effects has not yet been implemented.
- Checks involving transverse loads are not currently included.
- Design checks for angle sections are limited to $Util(F_{x_t})$ - utilisation for tension to clause 6.2.3, $Util(F_{x_c})$ - utilisation for compression to clause 6.2.4, and $Util(F_{x_{c,b}})$ - utilisation for compression member in buckling to clause 6.3.1.
- For compression checks of class 4 members, calculation of an additional moment ΔM_{Ed} due to eccentricity is not currently included.

- Rolled and welded sections can both be considered although the scope for welded sections is limited at present.
- Shear lag effects are not considered.
- Specific rules for steel buildings for seismic actions as per EN1998-1 Section 6 are not currently included.
- The bending capacity of a continuous structure made up of Class 1 or Class 2 sections in conjunction with Class 3 or Class 4 sections may be exceeded due to load shedding from the Class 1 or Class 2 sections to the Class 3 or Class 4 sections. To overcome this, a setting on the Steel Frame Design dialog for this design code permits the design of all Class 1 and Class 2 sections for bending using either plastic or elastic properties. For a structure made up of only Class 1 and Class 2 members the use of elastic section properties gives a more conservative design.

Implementation Notes

- See [Implementation Notes for Steel Frame Design Checks to EN1993-1-1 and EN1993-2](#) for more information.

Implementation Notes for Steel Frame Design Checks to EN1993-1-1 and EN1993-2

References cited are provided at the foot of this topic.

Material Properties

User-defined material can be defined and from the values entered LUSAS checks that the ductility requirements of 3.2.2 are met. However it is assumed that the requirements of 3.2.3 (Fracture toughness) and 3.2.4 (Through-thickness properties) are met and no check is carried out on these values.

Shear Buckling

- A limited number of RHS exceed the limiting web slenderness given by EN1993-1-1 clause 6.2.6 (6). This would imply that these sections should be subject to a shear buckling checks to EN 993-1-5, and require web posts and stiffeners to be provided, despite the impracticalities of this. However published section tables [S1] indicate that the capacity of these sections is as per EN 1993-1-1 clause 6.2.6 (2). This creates an inconsistency with the design checks carried out as an error is returned in these cases indicating that the shear buckling capacity has been exceeded.

- When calculating the contribution from flanges for Class 4 sections the limiting value of b_f is conservatively taken as being from the face of the web
- Longitudinal stiffeners are not considered.
- Design of the stiffener is not considered.

Shear, Bending, and Axial Force

- Clause 7.1 (2) of [B3] has not been implemented.
- The value of η_1 is used in place of η_{-1} as per sections 6.2.9.2.3 and 6.2.11.2.3 of [T3].
- Where the effects of bending moments in both directions are zero or negligible, but the axial load is not negligible a utilisation of 0 is returned. This is considered the most suitable result as the utilisation for combined bending and axial is based on modified bending moment capacities and applied bending moments only.
- When implementing Section 6.2.9 of EN1993-1-1 (Section 6.2.10 of EN1993-2) the approach used in the calculation is determined by the presence of either uniaxial bending effects and axial loading or biaxial bending effects with or without axial loading. This requires an assessment of whether or not a load effect is significant. A load effect is considered significant if it has a value greater than 0.1% of the yield stress.

Shear area factor

The factor for shear area is implemented as per the requirements of each of the national annexes to EN 1993-1-5 with the exception of those listed below. A user-defined value is also permitted. The following is noted:

- For the Italian national annex a conservative value of 1.0 is applied.
- The Finnish national annex relates the value to temperature as well as steel grade with a value of $\eta = 1.0$ used where temperatures exceed 400°C. This condition is not currently implemented.
- For the Recommended Values, Finland and Spain the value of η is taken as 1.2 for steel grades up to and including S460, higher steel grades are taken as 1.00. In order to facilitate user defined grades a yield strength of 460N/mm² rather than a steel grade is taken as the limiting value and these currently have an upper limit of 460N/mm².

Uniform Members in Compression

- In applying the requirements of Section 6.3.1.4 only slenderness for torsional buckling is applied to I-sections. Flexural torsional buckling is not considered as per Section 6.1(b) of the SCI Publication P363 [S4].
- Table 6.2 sets out the buckling curve to be used for various cross-sections and is dependent upon the grade of steel with two options given – grades S235, S275, S355 and S420 or alternatively grade S460. Grade S450 to EN10025-2 is not included in the table. Grade S450 is conservatively assigned to the former option.

Uniform Members in Bending

When considering lateral torsional buckling the effective length is taken as the same as the length due to flexure about the minor axis.

When considering the buckling resistance for uniform members in bending (Section 6.3.2) the elastic critical moment for lateral-torsional buckling, M_{cr} is used. EN1993-1-1 does not give guidance in how to determine this parameter. However methods are given in NCCI: Elastic critical moment for lateral torsional buckling [A1] which introduces parameters C1 and C2. A closed form expression has been put forward by Lopez et al [S5] to determine C1 and this method has been adopted in LUSAS to calculate C1 and ultimately M_{cr} .

The parameter C2 (which accounts for point of load application relative to shear centre) is currently ignored, i.e. the load is assumed to be applied through the shear centre. This approach is unconservative when loads are considered to have a destabilising effect.

When calculating M_{cr} , effective length factors k_z and k_w which account for end rotation on plan and end warping respectively are both taken as 1.0 as per guidance in reference [A1]. Lopez uses parameters k_1 and k_2 to consider lateral bending and warping at each end of a member to calculate C1 and both these parameters are conservatively taken as 1.0 i.e. free lateral bending and warping. Note that k_z and k_w refer to the length of the member while k_1 and k_2 refer to each end of the member.

Clause 6.3.2.2 (4) sets out conditions under which lateral torsional buckling effects may be ignored. These conditions are based on the parameter $\lambda_{LT,0}$ which is a NDP and is defined in clause 6.3.2.3 (1). This clause gives values of $\lambda_{LT,0}$ for rolled sections or equivalent welded sections, but there is no mention of hollow sections. However the UK National Annex explicitly includes hollow sections and this principle is adopted in applying clause 6.3.2.2 (4).

The second check in clause 6.3.2.2 (4) which applies a limit to the ratio M_{Ed}/M_{cr} below which the check is not required, has not been implemented.

Uniform Members in Bending and Axial Compression

When considering uniform members in bending and axial compression (Section 6.3.3), Table B.1 is for members not susceptible to torsional deformations while Table B.2 is for members susceptible to torsional deformations. As noted in Designers' Guide to EN1993-2 Eurocode 3: Design of Steel Structures. Part 2: Steel Bridges [T3] susceptibility to deformation is not defined. In LUSAS the sections not susceptible to torsional deformation are taken as follows:

- Square and circular hollow sections
- I-sections where the compression flange is restrained as described in section 1.3.5.1 of ref [J2]. This condition is also applied to rectangular hollow sections
- Where $\bar{\lambda} \leq 0.2$ and $\bar{\lambda}_{LT} \leq \bar{\lambda}_{LT,0}$
- Where $N_{Ed}/N_{cr} \leq 0.04$, $M_{Ed}/M_{cr} \leq 0.16$ and $M_{Ed}/M_{cr} \leq \bar{\lambda}_{LT,0}^2$.

Equivalent uniform moment factors C_m are determined from Table B.3 and for cases where there is either uniform or concentrated transverse load there is a requirement for parameter M_s . M_s is not defined, but is shown diagrammatically and is understood to be the sagging moment (the diagram also shows M_h at the end of the span, presumably the hogging moment). It is unclear where M_s is to be taken – is it at midspan or is it at the point of maximum sagging moment? Both interpretations have been used in various documents.

For LUSAS design check calculations the value of M_s is taken as the maximum.

Table B.3 notes that for members with sway buckling mode the equivalent uniform moment factor should be taken $C_{my} = 0.9$ or $C_{mz} = 0.9$. This requirement is not implemented and therefore the structure is taken as braced. This is noted in the Assumptions for the uniform members in bending and axial compression design check.

Class 4 sections

The optional slenderness reduction as per EN1993-1-5 Clause 4.4 (4) has not been included due to the iterative nature of the procedure.

A tolerance is set to determine the number of iterations required. The tolerance is set at 1% and is determined by the change in the values of the effective width, b_{eff} , between successive iterations compared to the original width, b .

When calculating the effective section properties for an I-section subject to flexure about the z-axis it is assumed that any shift in the position of the centroid results in it moving outside the plane of the web and thus ψ from Table 4.1 can be taken as 1.0

National Annex notes

Finland

- Additional grades of steel as defined in the Finnish National Annex to EN1993-1-5 can be defined using the User defined option from the Steel design standard dropdown list.
- The Finnish Finnish National Annex to EN1993-1-5 relates the value to temperature as well as steel grade with a value of $\eta = 1.0$ used where temperatures exceed 400°C. It is assumed that this condition will not be met and so this condition is not yet implemented.

Italy

- Ductility requirements for the Italian National Annex to EN1993-1-1 are dependent on the presence of dissipation zones in structures in seismic regions. Currently no option is provided to choose seismic or non-seismic regions. The default values are those given for non-seismic regions.

Spain

- When implementing the Ductility requirements, the Spanish National Annex to EN1993-1-1 explicitly states that the f_u/f_y ratio and the elongation at failure value are to be adopted. However no mention is made of the acceptable value of the ultimate strain. The recommended value in the EN1993-1-1 is adopted.

United Kingdom

- Ductility requirements for the UK National Annex to EN1993-1-1 are dependent on whether an elastic or plastic global analysis is carried out. The option is currently restricted to elastic global analysis.

References

A1 NCCI: Elastic critical moment for lateral torsional buckling SN003b-EN-EU, Access Steel, 2005

B3 BS EN 1993-1-5: 2006 Eurocode 3: Design of Steel structures – Part 1-5: Plated structural elements, British Standards Institution, Chiswick, Nov 2006

J2 Eurocodes: Background & Applications Design of Steel Buildings, M Veljkovic, L Simoes da Silva, R Simoes, F Wald, J P Jaspart, K Weynand, D Dubina, R Landolfo, P Vila Real, H Gervásio, Joint Research Centre, European Commission, 2015

S4 SCI Publication P363, Steel Building Design: Design Data, Steel Construction Institute, Berkshire & British Constructional Steelwork Association Limited, 2014

S5 Lateral-Torsional Buckling of Steel Beams: A General Expression for the Moment Gradient Factor, A López, D J Yong, M A Serna, International Colloquium on Stability and Ductility of Steel Structures, 2006,

T3 Designers' Guide to EN 1993-2 Eurocode 3: Design of Steel Structures. Part 2: Steel Bridges, C R Hendy, C J Murphy, Thomas Telford Limited, 2007

RC Slab Design

Overview

Reinforced concrete slab design facilities are accessed using the **Design> RC Slab Design...** menu item that is available for use with selected Bridge and Civil software products only. Contours and values that indicate flexural reinforcement requirements at Ultimate Limit State (ULS) or design crack width at Serviceability Limit State (SLS) can be plotted for design codes that support these calculations. The calculations carried out are for reinforced concrete slabs (without prestressing) that are modelled using plate or shell elements.

- For ULS, both bending only (using Wood-Armer), and bending and in-plane effects (using Clark-Nielsen) can be considered.
- For SLS, both bending-only (using principal moments), and bending and in-plane effects (using principal stresses) can be considered, if supported by a chosen design code.

Prior to carrying out RC slab design

Prior to obtaining and plotting RC slab design results, a slab model comprising plate or shell elements must be created, slab thicknesses and **slab reinforcement design attributes** must have been assigned to regions of the model where slab design is to take place, and loadings must also have been applied and the model solved. Loadcases considered and load combinations created should include those appropriate to ULS and/or SLS depending on the calculations to be carried out.

Usage

Design code settings and the choice of design calculation are made on the **Design Code Settings** dialog. A separate **Crack Width Settings** dialog is used to define parameters for SLS calculations.

Values and results contours for a chosen results component can be displayed for a stated slab face and for a previously chosen Code of Practice. Results are based on the active loadcase (or combination), using the most recently set results transformation, and are re-computed if a different loadcase is set active. See **RC Slab Design : Viewing Results** for more details.

Notes

- If RC Slab Designer calculations are based on a moment field (M_x , M_y , M_{xy}) only, users should ensure that in-plane effects are not significant, since slab design based upon Wood-Armer components may be unconservative in this case.
- The top and bottom faces of a slab are defined by the surface axes, and therefore it is helpful if they all point in the same respective directions.
- See [Background to Calculations Carried out by the Slab Designer](#) for additional information.

RC Slab Design : Design Code Settings and Parameters

On the main Design Code Settings page of the Slab Designer the design code, the design calculation method and the design parameters are defined. Slab depth values already specified by assignment of geometric properties and reinforcement arrangements specified by the assignment of RC Slab attributes to the model are used in any calculations carried out.

RC Slab Design: Design Code Settings

Design code

Country: Europe (Eurocode recommended values)

Design code: EN 1992-1-1:2004

Design calculations

ULS section design: Bending and in-plane forces (Clark-Nielsen)

SLS crack checking: Bending and in-plane forces (Principal stresses)

Design parameters

Characteristic yield strength of reinforcement (f_{yk})	500.0	MPa
Material factor for reinforcing steel (γ_s)	1.15	
Modulus of elasticity of reinforcing steel (E_s)	200.0	GPa
Characteristic cylinder strength of concrete (f_{ck})	40.0	MPa
Material factor for concrete (γ_c)	1.5	
Coefficient for long term and unfavorable effects (α_{cc})	1.0	

Defaults < Back Next > Finish Cancel Help

Design code

- Country** The list contains countries for which design codes are supported. Europe is included in the list, offering calculations to EN1992 with defaults based on Recommended values from the main Eurocode documents. This option, with or without modification of values, may be of particular use for countries where a National Annex is not yet published or not yet supported.
- Design Code** A list of Codes of Practice appropriate to the country previously selected. Calculations will be carried out in accordance with the selected Code of Practice.

Design Codes of Practice supported

The following Codes of Practice can be chosen from the Country and Design code drop-lists on the RC Slab Design main dialog:

- AASHTO LRFD 7th Edition (2014)** and **AASHTO LRFD 6th/5th Edition (2012/2010)** – listed under United States of America.
- AS5100.5-2004** and **AS3600-2009** - both listed under Australia
- British Standards: **BS5400-4-1990** (bridges), **BS8007:1987** (Structures retaining aqueous liquids) and **BS8110-1:1997** (Buildings) – all listed under United Kingdom.
- CAN/CSA S6-06** – listed under Canada.
- Eurocode EN1992-1-1** (buildings): implemented for Austria, Belgium, Bulgaria, Cyprus, Czech, Denmark, Finland, France, Germany, Greenland, Ireland, Italy, Netherlands, Poland, Romania, Singapore, Slovakia, Spain and United Kingdom. Default settings are listed under Europe (Eurocode Default Values).
- Eurocode EN1992-2** (bridges): implemented for Bulgaria, Cyprus, Denmark, Finland, Ireland, Italy, Spain, Sweden and United Kingdom. Default settings are listed under Europe (Eurocode Default Values).
- IRC: 112:2011** and **IRS:CBC-1997** - listed under India.
- SS CP65-1999** – listed under Singapore.

Design calculations.

ULS reinforcement design or SLS crack checking may be selected, although for some Codes of Practice the latter is not available.

- ULS section design** This option provides checks on flexural resistance based on assigned reinforcement arrangements.
 - **Bending only (Wood-Armer)** Calculations are based on Wood-Armer moments and resistances determined ignoring reinforcement in the compression zone. Each of the four layers of reinforcement may be checked in turn.

- **Bending and in-plane forces (Clark-Nielsen)** Calculations are based upon Clark-Nielsen forces, which are calculated based on lever arms determined from the reinforcement arrangement specified in a **RC slab reinforcement design attribute** when assigned to the model.
- ❑ **SLS crack checking** This option provides calculation of design crack widths for proposed reinforcement arrangements.
 - **Bending only (Principal moments)** Calculations are based on principal moments and make allowance for the non-alignment of principal moments and reinforcement. Crack widths can be viewed according to the reinforcement direction "controlling" the crack, such that each of the four layers of reinforcement can be checked in turn.
 - **Bending and in-plane effects (Principal stresses)** Calculations use principal stress to determine the orientation of the crack direction. The effective steel area is determined in the direction of the cracking plane. The neutral axis is calculated taking into account the presence of both applied force and moment.

If crack width calculation is supported by the chosen design code additional parameters need to be specified on the **Crack Width Calculation Settings** dialog.

The crack width calculation page is accessed from the **RC Slab Design Code Settings** dialog. Note that not all design codes supported by the RC Slab Design facility provide a methodology for explicit crack width calculation. For these codes no crack width calculations will be available.

Design codes that support crack width calculation are listed below. Specific parameters are explained separately for:

- ❑ United Kingdom [Eurocode / British Standards (various)]
- ❑ **CAN/CSA S6-06**
- ❑ **EN1992**
- ❑ **IRC:112-2011**
- ❑ **IRS:CBC-1997**
- ❑ **SS CP65**

Design Code Settings and Parameters for Australia (AS3600 / AS5100)

Selecting **Australia** and one of the design code options on the RC Slab Design: Design Code Settings dialog allows calculations, and offers defaults, based on the appropriate Australia publication below:

- AS 3600-2009 Australian Standard - Concrete Structures
- AS 5100.5-2004 Australian Standard - Bridge Design - Part 5

Note that regardless of model units, units in keeping with the design code stated are used, i.e. N/mm², millimetres etc., as displayed on the dialog.

General Settings

See [RC Slab Design : Design Code Settings](#) for details.

Design Calculations.

ULS reinforcement design is catered for but SLS crack checking is not available. This is because AS3600 and AS5100.5 code requirements do not include a crack width calculation.

Design Parameters

For AS 3600-2009 and AS 5100.5-2004 the following parameters are required:

- Characteristic compressive cylinder strength of concrete, f'_c** For ULS section design, f'_c is used in the calculation of the lever arm, z , and in determining if the section is tension-controlled. Typical values lie in the range 20 to 100N/mm². The default is 50N/mm²

- **Characteristic yield strength of reinforcement, f_{sy}** For ULS section design f_{sy} is used in the calculation of the area of reinforcing steel required (and bar diameters) and in determining if the section is tension-controlled. Typical values would be $f_y=250, 460$ or 500N/mm^2 and the default is 500N/mm^2 . The reinforcement class is specified as either Class N or Class L.

Reinforcement Details

See [RC Slab Design Attribute](#) for how to specify reinforcement arrangements. Australia-specific information is provided here:

- **Bar sizes** Nominal diameters (and cross-sectional areas) correspond to those readily available in Australia
- **Spacing [s]** Typical values lie in the range 40mm to 300mm. The default is 150mm.
- **Cover [c_{act}]** This is the cover used to calculate effective depths. Typical values for c_{act} lie in the range 25 to 65mm. The default is 50mm.

ULS Reinforcement Design to AS3600 and AS5100.5

See [Background to Calculations Carried out by the Slab Designer](#) for general information.

Area of steel required

The formulae used are summarised below:

AS 3600	AS5100.5
$A_{s,req} = \frac{M_d}{\phi f_{yd} z}$	$A_{s,req} = \frac{M_d}{\phi f_{yd} z}$
$z = d - \frac{\gamma k_u d}{2}$	$z = d - \frac{\gamma k_u d}{2}$
$k_u d = \frac{f_{yd} A_{s,prov}}{\alpha_2 f'_c b \gamma}$	$k_u d = \frac{f_{yd} A_{s,prov}}{0.85 f'_c b \gamma}$
Where $\alpha_2 = 1.0 - 0.003 f'_c$ and $\gamma = 1.05 - 0.007 f'_c$	Where $\gamma = [0.85 - 0.007 (f'_c - 28)]$

The nomenclature used above is as in the relevant codes excepting that:

$$A_{s,req} = \text{Area of tension reinforcement required}$$

Tension control ratio

The slab is ductile when the appropriate inequality below is met:

AS 3600	AS5100.5
$k_u \leq 0.36$	$k_u \leq 0.40$

Viewing ULS results

See [RC Slab Design : Viewing Results](#) for details of plotting ULS reinforcement design contours.

Design Code Settings and Parameters for CAN/CSA-S6-06

Selecting **Canada** on the main Design Code Settings page on the RC Slab Design: Design Code Settings dialog allows calculations, and offers defaults, based on the following publications:

- CAN/CSA-S6-06** Canadian Highway Bridge Design Code. Canadian Standards Association, Ontario, Nov 2006
- S6.1-06** Commentary on CAN/CSA-S6-06, Canadian Highway Bridge Design Code. Canadian Standards Association, Ontario, Nov 2006

Note that regardless of model units, units in keeping with the design code stated are used, i.e. MPa, millimetres etc.

RC Slab Design: Design Code Settings

Design code

Country: Canada

Design code: CAN/CSA-S6-06

Design calculations

ULS section design: Bending only (Wood-Armer)

SLS crack checking: Bending only (Principal moments)

Design parameters

Specified yield strength of reinforcing bars (f_y): 400.0 MPa

Resistance factor for reinforcing bars (ϕ_s): 0.9

Modulus of elasticity of reinforcing bars (E_s): 205.0 GPa

Specified compressive strength of concrete (f_c'): 40.0 MPa

Resistance factor for concrete (ϕ_c): 0.75

Defaults < Back Next > Finish Cancel Help

General Settings

See [RC Slab Design : Design Code Settings](#) for details.

Design Parameters

- Specified yield strength of reinforcement (f_y):** For ULS section design f_y is used in the calculation of the area of reinforcing steel required (and bar diameters) and in determining if the section is tension-controlled. It is not used for SLS crack checking calculations. Values acceptable in clause 8.4.2.1.3 lie in the range $f_y=300$ to 500MPa . The default is $f_y=400\text{MPa}$.
- Resistance factor for reinforcing bars (ϕ_s):** For ULS section design ϕ_s is used as the partial factor on material for the factored flexural resistance as seen in the commentary C8.8.4.1. It is also used in determining the distance between the neutral axis and the compressive face, hence affecting the lever arm calculated, and the classification of the section with regard to tension-control. It is not used for SLS crack checking calculations. From clause 8.4.6 & Table 8.1 the expected value, taken as the default, is $\phi_s = 0.90$.
- Modulus of elasticity of reinforcing bars (E_s):** For ULS section design E_s is used in determining if the section is tension-controlled. For SLS crack checking the value is used in the calculation of the depth in compression. From clause 8.4.3.3(b) the typical value, taken as the default, is $E_s=205\text{GPa}$.

- ❑ **Specified compressive strength of concrete (f_c'):** For ULS section design f_c' is used in the calculation of the lever arm, and in determining if the section is tension-controlled. For SLS crack checking the elastic modulus for concrete is determined using this value in the absence of specific user input. Values acceptable in clause 8.4.1.2 lie in the range 30 to 85MPa. The default is $f_c'=40\text{MPa}$.
- ❑ **Resistance factor for concrete (ϕ_c):** When ULS reinforcement design is selected, ϕ_c is used in determining the distance between the neutral axis and the compressive face, hence affecting the lever arm calculated, and the classification of the section with regard to tension-control. It is not used for SLS crack checking calculations. From clause 8.4.6 & Table 8.1 the expected value, taken as the default, is $\phi_c = 0.75$.

Reinforcement Details

See [RC Slab Design Attribute](#) for how to specify reinforcement arrangements. Canada code-specific information is provided here:

- ❑ **Bar sizes** Standard metric bar designations are used, representing the nominal bar diameter in millimetres rounded to the nearest 5mm.
- ❑ **Spacing [s]** Typical values lie in the range 50mm to 300mm. The default is 150mm.
- ❑ **Cover [c_{actual}]** This is the cover used to calculate effective depths, as distinct from nominal cover (c_{nom}), used in the calculation of crack widths (see below). For various reasons, including durability considerations or fixing tolerances, the specified actual cover (c_{act}) may be greater than the nominal cover. Typical values for actual cover would, however, lie in the range 30 to 80mm (Table 8.5).
- ❑ **Nominal cover** (used in crack width calculations) [c_{nom}] affects the design crack width calculation by changing the location at which the design crack width is assessed. In essence, the crack width is calculated at a plane lying a distance, c_{nom} , from the layer of bars controlling the crack. It is typically assumed that c_{nom} is equal to the actual cover, c_{act} , making the crack width plane described coincident with the tension face of the concrete. However when the actual cover is significantly greater than the cover required in Table 8.5, setting c_{nom} to the lower value will calculate the crack width on a plane internal to the concrete, resulting in a smaller calculated crack width, an approach that may be deemed appropriate in certain circumstances. Values for c_{nom} would therefore typically be by reference to Table 8.5.

Bar Designations

Bar Size	Bar Size Nominal Diameter (mm)
10M	11.3
15M	16
20M	19.5
25M	25.2
30M	29.9
35M	35.7
45M	43.7
55M	56.4

ULS Reinforcement Design to CAN/CSA-S6-06

See [Background to Calculations Carried out by the Slab Designer](#) for general information.

From clause 8.8.4.1, the factored flexural resistance is calculated in accordance with clause 8.8.3, assuming the relationship between concrete strain and the concrete compressive stress to be rectangular. The basic formula used can be derived directly from moment equilibrium or found with reference to the commentary C8.8.4.1, by eliminating irrelevant terms for prestress and flange width etc.

CAN/CSA-S6-06

Area of steel:

$$A_{s,req} = \frac{M_d}{\phi_s f_y \left(d_s - \frac{a}{2} \right)}$$

$$a = \frac{\phi_s f_y A_{s,prov}}{b \cdot \alpha_1 \phi_c f_c'}$$

$$\alpha_1 = \max(0.85 - 0.0015f_c', 0.67)$$

The nomenclature used above is as in the code excepting that:

M_d = factored moment at the section

$A_{s,req}$ = Area of tension reinforcement required

$A_{s,prov}$ = Area of tension reinforcement provided

For tension control the slab is ductile when the appropriate inequality below is met:

$$\frac{c}{d_s} \leq \left[\frac{\phi_s f_y}{E_s \varepsilon_{cu3}} + 1 \right]^{-1}$$

$$c = \frac{\alpha}{\beta_1}$$

$$\beta_1 = \max(0.97 - 0.0025f'_c, 0.67)$$

Where ε_{cu3} is the maximum usable strain at the extreme concrete compression fibre, taken as 0.0035 according to clause 8.8.3(c)

Viewing ULS results

See [RC Slab Designer : Viewing Results](#) for details of plotting ULS reinforcement design contours.

Crack Width Settings for CAN/CSA-S6-06

See [Background to Calculations Carried out by the Slab Designer](#) for general information.

The Crack Width Settings page is only available if the SLS crack checking option is selected on the Design Code Settings page.

Calculation properties

- **Allowable crack width (mm)** [w_{max}]. This value is used only to calculate crack width utilisation. A suitable value from clause 8.12.3.1, Table 8.6, would generally be either 0.25 or 0.35mm. The default is $w_{max}=0.25\text{mm}$

Tension Stiffening

Tension Stiffening (fw/fs). The expression for the average strain in the reinforcement, ϵ_{sm} includes a reduction due to the stiffening effect of tension carried by concrete. Where reinforcement does not lie perpendicular to cracks, whether the “tension stiffening” reduction should be included is a matter of debate (see SLS Crack Checking in [Background to Slab Design Calculations](#)). The Slab Designer offers crack check calculations with the tension stiffening component included, ignored (conservative) or interpolated. The “interpolated” option scales linearly from 0% tension stiffening at $\alpha=25^\circ$, to 100% at $\alpha=0^\circ$, and this is the default option.

- ❑ **Include** Considers tension stiffening for all angles
- ❑ **Ignore** Tension stiffening is completely ignored for conservative design.
- ❑ **Interpolate** (Default option) Provides a linear scale from 0% tension stiffening at $\alpha=25^\circ$, to 100% at $\alpha=0^\circ$.

Calculation of effective elastic modulus for concrete

In the calculation of crack widths, strains are assessed using an effective elastic modulus for concrete. This effective modulus may be calculated in a number of ways to suit the user and code of practice as follows:

- ❑ **Quasi-permanent** For this the effective elastic modulus for concrete is taken as the long-term value (from user input or calculated as described below). This is generally regarded as conservative in respect of the elastic and creep deformations that might be expected as a result of the mix of permanent and transient loads that are likely to affect the structure. Accordingly, this is the default option.
- ❑ **Interpolated, based on proportion** For this the effective elastic modulus for concrete is calculated using a ratio, R , of moments due to live loading (M_q) to total moments, ($M_g + M_q$). R is a single suitable value, determined by the user, that is entered as a percentage. The following expression (based on strain compatibility) is used to determine the effective modulus:

$$E_{c,eff} = \frac{E_{c,short} \times E_{c,long}}{E_{c,long} R + E_{c,short} (1 - R)}$$

- ❑ **Interpolated, based on calculated proportion** For this the effective elastic modulus for concrete is calculated using the ratio, R , as described above. In this case, however, R is evaluated at each node. The moments due to permanent loads, M_g , are taken from the loadcase selected in the droplist. The moments due to live loads, M_q , are taken from the active loadcase. The ratio at each node is:

$$R = \frac{M_q}{M_g + M_q}$$

Consistent with the above expression, total moments used for the calculation of crack width are based on $M_g + M_q$. The need for a suitable single value for R to be determined by the user is avoided.

Elastic Moduli

The elastic moduli for concrete and reinforcing steel are used in calculation of flexural strains in the slab, leading to the calculation of a design crack width.

- ❑ **Use code defined values** When this option is invoked, the moduli used in calculations (as required), are as stated in the table below.

**Short term modulus
for concrete**

**Long term modulus
for concrete**

$$E_{c,short} = E_{c,28} = (3000\sqrt{f'_c} + 6900) \left(\frac{\gamma_c}{2300} \right)^{1.5}$$

$$E_{c,long} = E_c(\infty, 28) = E_{c,28} [1 + \phi(\infty, 28)]^{-1}$$

Based on clause 8.4.1.7

Based on clause 8.4.1.6

The use of code defined values requires the entry of two further parameters:

- ❑ **Creep coefficient $\phi(\infty, 28)$** : This should be determined from clause 8.4.1.6.3. The default is taken as $\phi(\infty, 28) = 2.2$.
- ❑ **Mass density of concrete γ_c** : From clause 8.2 and clause 3.6, Table 3.3. The default is taken as $\gamma_c = 2450 \text{ kg/m}^3$.
- ❑ **User defined values** When this option is invoked, values for elastic moduli may be entered instead of using those determined automatically. The default values are based on the expressions described previously.

Canada crack width factors

- ❑ **Coefficient for aggregate type (k_{ag})** In clause 8.4.1.8.1, the cracking strength of concrete, f_{cr} , is seen to be dependent upon a constant, here named k_{ag} , and the root of the specified compressive strength. Clause 8.4.1.8.1 takes a value of k_{ag} in the range 0.3 to 0.4 according to the density of the concrete. The default is taken as $k_{ag} = 0.4$, appropriate to normal-density concrete.
- ❑ **Coefficient for bond properties (k_b)** In clause 8.12.3.2, k_b is taken as 1.2 for components with epoxy-coated reinforcing steel and 1.0 for all other components. The default is $k_b = 1.0$.
- ❑ **Coefficient for strain distribution (k_c)** In clause 8.12.3.2, k_c is a coefficient which takes account of the form of the strain distribution, with the values 0.5 for bending and 1.0 for pure tension. The commentary C8.12.3.2 refers to DD ENV 1992-1-1, in which clause 4.4.2.4(3) gives guidance for cases of eccentric tension. The appropriate value would in most cases be 0.5 and the default is accordingly $k_c = 0.5$.
- ❑ **Coefficient for the cause of cracking (β_c)** In clause 8.12.3.2, β_c is seen to be determined by the cause of the cracking and the section depth. When cracking is caused by load, $\beta_c = 1.7$. When cracking is caused by superimposed deformations, β_c is taken as 1.7 where the section has a minimum dimension greater than 800mm, and taken as 1.3 where the minimum dimension is less than or equal to 300mm. The default is $\beta_c = 1.7$.
- ❑ **Ratio of max to mean crack width (κ_c)** In the commentary in clause C8.12.3.2, “Maximum crack width, which is the quantity required for design, is obtained by multiplying average crack width by the parameter κ_c .” It appears that the coefficient, κ_c , here is not the same as k_c in clause 8.12.3.2 (described above), since that has a value of 0.5 for sections in bending, which would not be appropriate for obtaining a maximum value from an average value. The ratio is therefore here named κ_c . No suggested value for κ_c is given in either the code

or the commentary but it is thought to generally lie in the range $1.0 < \kappa_c \leq 1.7$.
In the absence of data, the default is taken as $\kappa_c=1.0$

SLS crack width calculation to CAN/CSA-S6-06

Crack width calculations for CAN/CSA-S6-06 are carried out by reference to clauses 8.12.3.2 and 8.4.1.8.1 and 8.8.4.4:

CAN/CSA-S6-06

Effective area of concrete in tension:

$$A_{ct} = b \cdot \min \left\{ 2.5(h - d_s), \frac{1}{3}(h - x) \right\}$$

$$\rho_c = \frac{A_s}{A_{ct}}$$

Crack spacing:

$$s_{rm} = 50 + 0.25k_c \frac{d_b}{\rho_c}$$

Cracking stress and cracking moment:

$$f_{cr} = k_{ag} \sqrt{f'_c}$$

$$M_{cr} = \frac{bh^3}{12} \frac{f_{cr}}{(h/2 - c_{act} + c_{nom})}$$

Stresses in the tension reinforcement (cracked section):

$$f_s = \frac{M_s}{A_{s,prov}(d_s - x/3)} \quad f_w = \frac{M_{cr}}{A_{s,prov}(d_s - x/3)}$$

Average strains in the reinforcement:

$$\varepsilon_{sm} = \frac{f_s}{E_s} \left[1 - \left(\frac{f_w}{f_s} \right)^2 \right]$$

Average crack widths:

$$w = k_b \beta_c s_{rm} \varepsilon_{sm}$$

Maximum crack width:

$$w_k = \kappa_c w$$

Viewing SLS results

See [RC Slab Design : Viewing Results](#) for details of plotting SLS reinforcement design contours.

Design Code Settings and Parameters for Europe (Eurocodes)

Selecting **Europe (Eurocode recommended values)** and one of the EN design code options on the RC Slab Design: Design Code Settings dialog allows calculations, and offers defaults, based on either:

- EN1992-1-1:2004 Eurocode 2:** Design of concrete structures - Part 1-1: General rules and rules for buildings. English version published within BS EN1992-1-1:2004, British Standards Institution, 23 December 2004
- EN1992-2:2005 Eurocode 2:** Design of concrete structures - Part 2: Concrete bridges – Design and detailing rules. English version published within BS EN1992-2:2005, British Standards Institution, 2 December 2005

Selecting a supported **Country** and a corresponding **Eurocode** will set the Nationally Determined Parameters (NDPs) for that country and code. See [Eurocode supported countries and their respective National Annexes](#) for more details. The NDPs are read from an external file and can be set manually extended with additional NDPs, which will then be made available in the country selection on this page.

Note that regardless of model units, units in keeping with the design code stated are used, i.e. MPa, millimetres etc.

RC Slab Design: Design Code Settings

Design code

Country: Europe (Eurocode recommended values)

Design code: EN 1992-1-1:2004

Design calculations

ULS section design: Bending and in-plane forces (Clark-Nielsen)

SLS crack checking: Bending and in-plane forces (Principal stresses)

Design parameters

Characteristic yield strength of reinforcement (f_{yk}): 500.0 MPa

Material factor for reinforcing steel (γ_s): 1.15

Modulus of elasticity of reinforcing steel (E_s): 200.0 GPa

Characteristic cylinder strength of concrete (f_{ck}): 40.0 MPa

Material factor for concrete (γ_c): 1.5

Coefficient for long term and unfavorable effects (α_{cc}): 1.0

Buttons: Defaults, < Back, Next >, Finish, Cancel, Help

General Settings

See [RC Slab Design : Design Code Settings](#) for details.

Design Parameters

- Characteristic yield strength of reinforcement (f_{yk})** : For ULS section design f_{yk} is used in the calculation of the area of reinforcing steel required (and bar diameters) and in determining if the section is tension-controlled. It is not used for SLS crack checking calculations. Values acceptable in clause 3.2.2(3) lie in the range $f_{yk}=400$ to 600 MPa. The default is $f_{yk}=500$ MPa.
- Material factor for reinforcing steel (γ_s)** : For ULS section design γ_s is used in determining the design strength for concrete, hence affecting calculation of the depth in compression, the lever arm, classification of the section with regard to tension-control and the area of steel required directly. It is not used for SLS crack checking calculations. From clause 2.4.2.4 & Table 2.1N γ_s is an NDP and therefore suitable defaults are taken from the appropriate National Annex. Since different values apply for “accidental” design situations as compared to “persistent and transient” design situations, the defaults are for the latter. Broadly speaking $\gamma_s=1.15$ is adopted by most countries.
- Elastic modulus of reinforcing steel (E_s)** : For ULS section design E_s is used in determining if the section is tension-controlled. For SLS crack checking the

value is used in the calculation of the depth in compression. From clause 3.2.7(4) the typical value, taken as the default, is $E_s=200\text{GPa}$

- ❑ **Characteristic compressive cylinder strength of concrete (f_{ck})** : For ULS section design f_{ck} is used in the calculation of the lever arm, and in determining if the section is tension-controlled. For SLS crack checking the elastic modulus for concrete is determined using this value in the absence of specific user input. Values in EN1992-1-1 Table 3.1 lie in the range 12 to 90MPa. The default is $f_{ck}=40\text{MPa}$.
- ❑ **Material factor for concrete (γ_c)** : For ULS section design γ_c is used in determining the design strength for concrete, hence affecting calculation of the depth in compression, the lever arm, and the classification of the section with regard to tension-control. It is not used for SLS crack checking calculations. From clause 2.4.2.4 & Table 2.1N γ_c is an NDP and therefore suitable defaults are taken from the appropriate National Annex. Since different values apply for “accidental” design situations as compared to “persistent and transient” design situations, the defaults are for the latter. Broadly speaking $\gamma_c=1.50$ is adopted by most countries.
- ❑ **Coefficient for long term and unfavourable effects (α_{cc})** : For ULS section design α_{cc} is used in determining the design strength for concrete, hence affecting calculation of the depth in compression, the lever arm, and the classification of the section with regard to tension-control. It is not used for SLS crack checking calculations. From clause 3.1.6(1) α_{cc} is an NDP and therefore suitable defaults are taken from the appropriate National Annex. Broadly speaking values of $\alpha_{cc}=1.0$ (buildings) and $\alpha_{cc}=0.85$ (bridges) are adopted by most countries.

Reinforcement Details

See [RC Slab Design Attribute](#) for how to specify reinforcement arrangements. Eurocode-specific information is provided here:

- ❑ **Bar sizes** Standard metric bar designations are used.
- ❑ **Spacing [s]** Typical values lie in the range 25mm to 300mm. The default is 150mm.
- ❑ **Cover [c_{act}]** This is the cover used to calculate effective depths, the “nominal cover specified on the drawings” as in clause 4.4.1.1(2). This may sometimes be distinct from the cover distance used in the calculation of crack widths (see below). Typical values for cover would lie in the range 15 to 65mm.
- ❑ **Nominal cover** (used in crack width calculations) [c_{cr}]. This value affects the design crack width calculation by changing the location at which the design crack width is assessed. In essence, the crack width is calculated at a plane lying a distance, c_{cr} , from the layer of bars controlling the crack. It is typically assumed that c_{cr} is equal to the actual cover (typically based on c_{nom}), making the crack width plane described coincident with the tension face of the concrete. However when the actual cover is significantly greater than the cover

required in clause 4.4.1, setting c_{cr} to the lower value will calculate the crack width on a plane internal to the concrete, resulting in a smaller calculated crack width, an approach which may be deemed appropriate in certain circumstances. Values for c_{cr} would therefore typically be by reference to clause 4.4.1.

ULS Reinforcement Design Output

See [Background to Calculations Carried out by the Slab Designer](#) for general information.

The flexural resistance is calculated in accordance with clauses 3.1.6 and 3.1.7 and Figure 3.5 – assuming a rectangular stress distribution in the compression zone. The basic formula used can be derived directly from moment equilibrium and strain compatibility.

Area of steel required

The formulae used are summarized below:

EN1992

$$f_{cd} = \frac{\alpha_{cc} f_{ck}}{\gamma_c}$$

$$\lambda = \text{if} \left\{ f_{ck} \leq 50 \text{MPa}, 0.8, 0.8 - \frac{f_{ck} - 50}{400} \right\}$$

$$\eta = \text{if} \left\{ f_{ck} \leq 50 \text{MPa}, 1.0, 1.0 - \frac{f_{ck} - 50}{200} \right\}$$

$$\rho_1 = \frac{A_{s,prov}}{bd} \quad x = d \frac{f_{yd}}{\eta f_{cd} \lambda} \rho_1 \quad z = d - \frac{\lambda x}{2}$$

$$A_{s,req} = \frac{M_d}{f_{yd} z}$$

The nomenclature used above is as in the code excepting that:

M_d = factored moment at the section

$A_{s,req}$ = Area of tension reinforcement required

$A_{s,prov}$ = Area of tension reinforcement provided

Tension control ratio

The slab is ductile when the appropriate inequality below is met:

$$\varepsilon_{cu3} = \text{if } \left\{ f_{ck} < 50\text{MPa}, 3.5\text{‰}, 2.6 + 35 \left[\frac{(90 - f_{ck})}{100} \right]^4 \text{‰} \right\}$$

$$\frac{x}{d} \leq \left[\frac{f_{yd}}{E_s \varepsilon_{cu3}} + 1 \right]^{-1}$$

Viewing ULS results

See [RC Slab Design : Viewing Results](#) for details of plotting ULS reinforcement design contours.

Crack Width Settings

See [Background to Calculations Carried out by the Slab Designer](#) for general information.

The Crack Width Settings page is shown if the Next button is pressed on the Design Code Settings dialog. Settings for Eurocodes are described here:

Calculation properties

- Allowable crack width** [w_{\max}] This value is used only to calculate crack width utilisations. From EN1992-1-1 clause 7.3.1(5), Table 7.1N, w_{\max} is a NDP and therefore suitable defaults are taken from the appropriate National Annex. Broadly speaking a value of $w_{\max}=0.30$ is adopted by most countries.

Tension Stiffening

The expression for the average strain in the reinforcement, ε_{sm} includes a reduction in consideration of the stiffening effect of tension carried by concrete. Where reinforcement does not lie perpendicular to cracks, whether the “tension stiffening” reduction should be included is a matter of debate (see SLS Crack Checking in [Background to Slab Designer Calculations](#)). The Slab Designer offers crack check calculations with the tension stiffening component included, ignored (conservative) or interpolated.

- Include** Considers tension stiffening for all angles
- Ignore** Tension stiffening is completely ignored for conservative design.
- Interpolate** (Default option) Scales linearly from 0% tension stiffening at $\alpha=25^\circ$, to 100% at $\alpha=0^\circ$.

Calculation of effective elastic modulus for concrete

In the calculation of crack widths, strains are assessed using an effective elastic modulus for concrete. This effective modulus may be calculated in a number of ways to suit the user and code of practice as follows:

- ❑ **Quasi-permanent, based upon creep coefficient** For this the effective elastic modulus for concrete is taken as the long-term value (from user input or calculated as described below). This is generally regarded as conservative in respect of the elastic and creep deformations that might be expected as a result of the mix of permanent and transient loads that are likely to affect the structure. Accordingly, this is the default option.
- ❑ **Interpolated, based on proportion** For this the effective elastic modulus for concrete is calculated using a ratio, R, of moments due to live loading (M_q) to total moments, (M_g+M_q). R is a single value, determined by the user, which is entered as a percentage. The following expression (based on strain compatibility) is used to determine the effective modulus:

$$E_{c,eff} = \frac{E_{c,short} \times E_{c,long}}{E_{c,long}R + E_{c,short}(1 - R)}$$

- ❑ **Interpolated, based on calculated proportion** For this the effective elastic modulus for concrete is calculated using the ratio, R, as described above. In this case, however, R is evaluated at each node. The moments due to permanent loads, M_g , are taken from the loadcase selected in the droplist. The moments due to live loads, M_q , are taken from the active loadcase. The ratio at each node is:

$$R = \frac{M_q}{M_g + M_q}$$

Consistent with the above expression, total moments used for the calculation of crack width are based on $M_g + M_q$. The need for a suitable single value for R to be determined by the user is avoided.

Elastic Moduli

The modulus of elasticity of concrete, E_c , is used in calculation of flexural strains in the slab, leading to the calculation of a design crack width.

- ❑ **Use code defined values** When this option is invoked, the moduli used in calculations (as required), will be as follows:

- Short term modulus based upon Table 3.1

$$E_{c,short} = E_{cm} = 22 \left(\frac{f_{cm}}{10} \right)^{0.3} \quad \text{where } f_{cm} = f_{ck} + 8$$

This value must be adjusted for the aggregate in use according to clause 3.1.3(2).

- Long term modulus for concrete assuming linear creep as in clause 7.2(3), can be based on clause 3.1.4.

$$E_{c,long} = E_c(\infty, t_0) = E_{cm} \left[1 + \frac{\varphi(\infty, t_0)}{1.05} \right]^{-1}$$

Use of the code defined values option requires the entry of two further parameters:

- Creep coefficient φ** : This should be determined from clause 3.1.4 (Fig 3.1). The default is taken as $\psi = 2.2$.
- Aggregate type** : From clause 3.1.3(2) four types are offered which modify the Modulus of Elasticity as appropriate.
- User defined values** When this option is invoked, values for elastic moduli may be entered instead of using those determined automatically. The default values are based on the expressions described previously.

Eurocode crack width factors

- Coefficient for load duration (Kt)** : Coefficient for duration of loading, k_t . In clause 7.3.4(2), k_t is given as 0.6 for short term loading or 0.4 for long term loading. For most nations, crack width calculations are for the quasi-permanent design situation in the Eurocode (see EN1992-1-1 Table 7.1N and EN1992-2 Table 7.101N), therefore the default is taken as $k_t=0.4$.
- Coefficient for bond properties (K1)** : In clause 7.3.4(3), k_1 is a coefficient which takes account of the bond properties of the bonded reinforcement, taken as 0.8 for high bond bars or 1.6 for bars with an effectively plain surface. The default is $k_1 = 0.8$.
- Coefficient for strain distribution (K2)** : In clause 7.3.4(3), k_2 is a coefficient which takes account of the form of the strain distribution, with the values 0.5 for bending and 1.0 for pure tension. The appropriate value would in most cases be 0.5 and the default is accordingly $k_2=0.5$.
- Coefficient for cover influence (K3)** Coefficient controlling the influence of cover on crack spacing. In clause 7.3.4(3), k_3 is an NDP. It requires special treatment for some nations and is taken to be of the form:

$$k_3 = k_{3A} \cdot \varnothing^{k_{3B}} \cdot c_{cr}^{k_{3C}}$$

where generally $k_{3B} \geq 0$ and $k_{3C} \leq 0$. For most nations, $k_{3A}=3.4$, $k_{3B}=0$ and $k_{3C}=0$, but defaults are set as appropriate to the National Annex.

- **Coefficient for bar diameter (K4):** Coefficient controlling the influence of bar diameter on crack spacing. In clause 7.3.4(3), k_4 is an NDP and therefore suitable defaults are taken from the appropriate National Annex. Broadly speaking a value of $k_4=0.425$ is adopted by most countries.

SLS crack width calculation to Eurocode

Crack width calculations for EN1992 are carried out by reference to clause 7.3.4 and 7.3.2(3):

EN1992

Effective area of concrete in tension:

$$A_{c,eff} = b \cdot \min \left\{ 2.5(h - d), \frac{h - x}{3}, \frac{h}{2} \right\}$$

$$\rho_{p,eff} = A_{s,prov} / A_{c,eff}$$

Crack spacing:

$$s_{r,max} = \text{if} \left\{ s \leq 5 \left(c + \frac{\phi}{2} \right), k_3 c + \frac{k_1 k_2 k_4 \phi}{\rho_{p,eff}}, 1.3(h - x) \right\}$$

Cracking strain showing tension stiffening component in square brackets:

$$\varepsilon_{sm} - \varepsilon_{cm} = \frac{\sigma_s - k_t f_{ct,eff} \alpha_s}{E_s} - \left[\frac{k_t \frac{f_{ct,eff}}{\rho_{p,eff}}}{E_s} \right]$$

The mean value of the tensile strength of the concrete effective at the time when cracks may be first expected to occur:

$$f_{ct,eff} = f_{ctm} = \text{if} \left\{ f_{ck} \leq 50, 0.3 f_{ck}^{2/3}, 2.12 \ln \left(1 + \frac{f_{ck} + 8}{10} \right) \right\}$$

Crack widths:

$$w_k = s_{r,max}(\varepsilon_{sm} - \varepsilon_{cm})$$

Viewing SLS results

See [RC Slab Design : Viewing Results](#) for details of plotting SLS reinforcement design contours.

Eurocode supported countries and their respective National Annexes

Selecting a Eurocode country and “EN1992-1-1” or “EN1992-2” design code makes the RC Slab designer perform calculations, and offer defaults, based on the following publications:

Country	National Annex reference document
Austria	ONORM EN 1992-1-1/NA:2007
Belgium	prNBN EN 1992-1-1/NA:2007
Bulgaria	BDS EN 1992-1-1:2005/NA:2011 and BDS EN 1992-2:2006/NA:2012
Cyprus	CYS EN 1992-1-1:2005/NA:2009 and CYS EN 1992-2:2006/NA:2009
Czech Republic	CSN EN 1992-1-1/NA:2007
Denmark	DS/EN 1992-1-1 DK NA:2011 and VD/EN 1992-2 DK NA:2009
Finland	SFS-EN 1992-1-1/NA:2009 and SFS-EN 1992-2/NA:2010
France	NF EN 1992-1-1/NA:2007
Germany	prDIN EN 1992-1-1/NA:2009
Greenland	DS/EN 1992-1-1 GL NA:2009
Ireland	I.S. EN 1992-1-1/NA: 2010 and I.S. EN 1992-2/NA: 2010
Italy	UNI-EN 1992-1-1/ NA:2007 and UNI-EN 1992-2/NA:2007
Netherlands	NEN EN 1992-1-1/NA:2007
Poland	PN EN 1992-1-1/NA:2008
Romania	SR EN 1992-1-1/NB 2008 and SR EN 1992-2/NB 2009
Singapore	SS EN 1992-1-1/NA 2008 inc Amd 1
Slovakia	STN EN 1992-1-1/NA:2007
Spain	AN/UNE-EN 1992-1-1: 2012 and AN/UNE-EN 1992-2: 2012
Sweden	TRVFS 2011:12 (EN 1992)
United Kingdom	BS EN 1992-1-1:2004/ NA: 2005 and BS EN 1992-2:2005/ NA: 2007

Nationally determined parameters (NDP) for these countries are stored in the **EurocodeParameters.xml** file in the <LUSAS Installation Folder>\Programs\scripts\User folder. When a national annex of the Eurocode is selected the NDP's are read from the xml file and displayed in the text fields on the dialog for use in the calculations. Additional national annexes added to the file will be displayed in the list of available design codes. Note the design calculations carried out for all Eurocodes are the same, only the values of the NDPs change when selecting national annexes.

Design Code Settings and Parameters for India

IRC:112-2011

Selecting **India** and the IRC:112-2011 design code option on the main Design Code Settings page on the RC Slab Design: Design Code Settings dialog allows calculations, and offers defaults, based on:

- ❑ **IRC: 112:2011:** Code of Practice for Concrete Road Bridges, Indian Roads Congress. (Indian Highway Bridge Design Code)

Note that regardless of model units, units in keeping with the design code stated are used, i.e. Mpa, millimetres etc., as shown on the dialog.

RC Slab Design: Design Code Settings

Design code

Country: India

Design code: IRC:112-2011

Design calculations

ULS section design: Bending and in-plane forces (Clark-Nielsen)

SLS crack checking: Bending and in-plane forces (Principal stresses)

Design parameters

Characteristic yield strength of reinforcement (fyk)	500.0	MPa
Material factor for reinforcing steel (ys)	1.15	
Modulus of elasticity of reinforcing steel (Es)	200.0	GPa
Characteristic cylinder strength of concrete (fck)	40.0	MPa
Material factor for concrete (yc)	1.5	
Coefficient for long term and unfavorable effects (α)	0.67	

Defaults < Back Next > Finish Cancel Help

General Settings

See [RC Slab Design : Design Code Settings](#) for details.

Design Parameters

- ❑ **Characteristic yield strength of reinforcement (f_{yk})** : For ULS section design f_{yk} is used in the calculation of the area of reinforcing steel required (and bar diameters) and in determining if the section is tension-controlled. It is not used for SLS crack checking calculations. Values acceptable in clause 6.2.2, Table 18.1 lie in the range $f_{yk}=240$ to 600MPa. The default is $f_{yk}=500$ MPa.
- ❑ **Material factor for reinforcing steel (γ_s)** : For ULS section design γ_s is used in determining the design strength for concrete, hence affecting calculation of the depth in compression, the lever arm, classification of the section with regard to tension-control and the area of steel required directly. It is not used for SLS crack checking calculations. Broadly speaking γ_s is taken as 1.15 for basic and seismic combination.
- ❑ **Elastic modulus of reinforcing steel (E_s)** : For ULS section design E_s is used in determining if the section is tension-controlled. For SLS crack checking the value is used in the calculation of the depth in compression. From clause 6.2.2 the typical value, taken as the default, is $E_s=200$ GPa
- ❑ **Characteristic compressive cylinder strength of concrete (f_{ck})** : For ULS section design f_{ck} is used in the calculation of the lever arm, and in determining if the section is tension-controlled. For SLS crack checking the elastic modulus for concrete is determined using this value in the absence of specific user input for that parameter. Refer to IRC:112-2011 Table 6.5 for a range of values. The default is $f_{ck}=40$ MPa.
- ❑ **Material factor for concrete (γ_c)** : For ULS section design γ_c is used in determining the design strength for concrete, hence affecting calculation of the depth in compression, the lever arm, and the classification of the section with regard to tension-control. It is not used for SLS crack checking calculations. Broadly speaking γ_c is taken as 1.15 for basic and seismic combination.
- ❑ **Coefficient for long term and unfavourable effects (α)** : For ULS section design α is used in determining the design strength for concrete, hence affecting calculation of the depth in compression, the lever arm, and the classification of the section with regard to tension-control. It is not used for SLS crack checking calculations. For IRC:112-2011 a value of $\alpha =0.67$ is used.

Reinforcement Details

See [RC Slab Design Attribute](#) for how to specify reinforcement arrangements. India IRC:112-2011-specific information is provided here:

- ❑ **Bar sizes** Standard metric bar designations are used.
- ❑ **Spacing [s]** Typical values lie in the range 25mm to 300mm. The default is 150mm.

- ❑ **Cover** [c_{act}] This is the cover used to calculate effective depths, the “nominal cover specified on the drawings”. The default is 45mm. This may sometimes be distinct from the cover distance used in the calculation of crack widths c_{cr} .
- ❑ **Nominal cover** (used in crack width calculations) This value affects the design crack width calculation by changing the location at which the design crack width is assessed. In essence, the crack width is calculated at a plane lying a distance, c_{cr} , from the layer of bars controlling the crack. It is typically assumed that c_{cr} is equal to the actual cover (typically based on c_{nom}), making the crack width plane described coincident with the tension face of the concrete. However when the actual cover is significantly greater than the cover required in clause 14.3.2.1 Table 14.2, setting c_{cr} to the lower value will calculate the crack width on a plane internal to the concrete, resulting in a smaller calculated crack width, an approach which may be deemed appropriate in certain circumstances. Values for c_{cr} would therefore typically be by reference to clause 14.3.2.1 and the default is 45mm.

ULS Reinforcement Design Output

See [Background to Calculations Carried out by the Slab Designer](#) for general information.

The flexural resistance is calculated in accordance with clauses 6.4.2.8(1)(a) and 6.4.2.8(1)(b) and Figure A2-4 – assuming a rectangular stress distribution in the compression zone. The basic formula used can be derived directly from moment equilibrium and strain compatibility.

IRC:112-2011

Area of steel:

$$z = d - \frac{\lambda x}{2} \quad ; \quad f_{cd} = \frac{\alpha_{cc} f_{ck}}{\gamma_c}$$

$$\lambda = \text{if} \left\{ f_{ck} \leq 60 \text{MPa}, 0.8, 0.8 - \frac{f_{ck} - 60}{500} \right\}$$

$$\eta = \text{if} \left\{ f_{ck} \leq 60 \text{MPa}, 1.0, 1.0 - \frac{f_{ck} - 60}{250} \right\}$$

$$\rho_1 = \frac{A_{s,prov}}{bd} \quad x = d \frac{f_{yd}}{\eta f_{cd} \lambda} \rho_1 \quad z = d - \frac{\lambda x}{2}$$

$$A_{s,req} = \frac{M_d}{f_{yd}z}$$

The nomenclature used above is as in the code excepting that:

M_d = factored moment at the section

$A_{s,req}$ = Area of tension reinforcement required

$A_{s,prov}$ = Area of tension reinforcement provided

For tension control the slab is ductile when the appropriate inequality below is met:

$$\varepsilon_{cu3} = \text{if} \left\{ f_{ck} > 60\text{MPa}, 2.6 + 35 \left[\frac{(90 - 0.8f_{ck})}{100} \right]^4, 3.5 \right\} \text{‰}$$

$$\frac{x}{d} \leq \left[\frac{f_{yd}}{E_s \varepsilon_{cu3}} + 1 \right]^{-1}$$

Viewing ULS results

See [RC Slab Design : Viewing Results](#) for details of plotting ULS reinforcement design contours.

Crack Width Settings

See [Background to Calculations Carried out by the Slab Designer](#) for general information.

The Crack Width Settings page is only available if the SLS crack checking option is selected on the Design Code Settings page.

Calculation properties

- Allowable crack width** [w_{max}] This value is used only to calculate crack width utilisations. Refer to IRC:112-2011 Table 12.1. A default of 0.3mm is used.

Tension Stiffening

The expression for the average strain in the reinforcement, ϵ_{sm} includes a reduction in consideration of the stiffening effect of tension carried by concrete. As described in SLS crack checking, where reinforcement does not lie perpendicular to cracks, whether the “tension stiffening” reduction should be included is a matter of debate. The Slab Designer offers crack check calculations with the tension stiffening component included, ignored (conservative) or interpolated.

- Include** Considers tension stiffening for all angles
- Ignore** Tension stiffening is completely ignored for conservative design.
- Interpolate** (Default option) Scales linearly from 0% tension stiffening at $\alpha=25^\circ$, to 100% at $\alpha=0^\circ$.

Calculation of effective elastic modulus for concrete

In the calculation of crack widths, strains are assessed using an effective elastic modulus for concrete. This effective modulus may be calculated in a number of ways to suit the user and code of practice as follows:

- ❑ **Quasi-permanent, based upon creep coefficient** For this the effective elastic modulus for concrete is taken as the long-term value (from user input or calculated as described below). This is generally regarded as conservative in respect of the elastic and creep deformations that might be expected as a result of the mix of permanent and transient loads that are likely to affect the structure. Accordingly, this is the default option.
- ❑ **Interpolated, based on proportion** For this the effective elastic modulus for concrete is calculated using a ratio, R , of moments due to live loading (M_q) to total moments, ($M_g + M_q$). R is a single value, determined by the user, that is entered as a percentage. The following expression (based on strain compatibility) is used to determine the effective modulus:

$$E_{c,eff} = \frac{E_{c,short} \times E_{c,long}}{E_{c,long} R + E_{c,short} (1 - R)}$$

- ❑ **Interpolated, based on calculated proportion** For this the effective elastic modulus for concrete is calculated using the ratio, R , as described above. In this case, however, R is evaluated at each node. The moments due to permanent loads, M_g , are taken from the loadcase selected in the droplist. The moments due to live loads, M_q , are taken from the active loadcase. The ratio at each node is:

$$R = \frac{M_q}{M_g + M_q}$$

Consistent with the above expression, total moments used for the calculation of crack width are based on $M_g + M_q$. The need for a suitable single value for R to be determined by the user is avoided.

Elastic Moduli

The modulus of elasticity of concrete, E_c , is used in calculation of flexural strains in the slab, leading to the calculation of a design crack width.

- ❑ **Use code defined values** When this option is invoked, the moduli used in calculations (as required), will be as follows:

- **Short term modulus of concrete** based upon Eq. A2-5.

$$E_{c,short} = E_{cm} = 22 \left(\frac{f_{cm}}{10} \right)^{0.3} \quad \text{where} \quad f_{cm} = f_{ck} + 10$$

- **Long term modulus of concrete** based upon Eq. 12.15.

$$E_{c,long} = E_c(\infty, t_0) = E_{cm} [1 + \varphi(\infty, t_0)]^{-1}$$

Use of code defined values requires the entry of a further parameter:

- ❑ **Creep coefficient (Phi)** : This should be determined from clause 6.4.2.7, Table 6.9. The default is taken as $\Phi = 2.2$.
- ❑ **Aggregate type** : From Table 6.5(2) four types are offered which modify the Modulus of Elasticity as appropriate.
- ❑ **User defined values** When this option is invoked, values for elastic moduli may be entered instead of using those determined automatically. The default values are based on the expressions described previously.

Crack width parameters

- ❑ **Coefficient for load duration (Kt)** : Coefficient for duration of loading, k_t . In clause 12.3.4(2), k_t is given as 0.5 and hence the default is taken as $k_t=0.5$.
- ❑ **Coefficient for bond properties (K1)** : In clause 12.3.4(3), k_1 is a coefficient which takes account of the bond properties of the bonded reinforcement, taken as 0.8 for high bond bars or 1.6 for bars with an effectively plain surface. The default is $k_1 = 0.8$.
- ❑ **Coefficient for strain distribution (K2)** : In clause 12.3.4(3), k_2 is a coefficient which takes account of the form of the strain distribution, with the values 0.5 for bending and 1.0 for pure tension. The appropriate value would in most cases be 0.5 and the default is accordingly $k_2=0.5$.

SLS crack width calculation

Crack width calculations for IRC:112-2011 are carried out by reference to clauses 12.3.4 and 12.3.3:

IRC:112-2011

Effective area of concrete in tension:

$$A_{c,eff} = b \cdot \min \left\{ 2.5(h - d), \frac{h - x}{3}, \frac{h}{2} \right\}$$

$$\rho_{p,eff} = A_{s,prov} / A_{c,eff}$$

Crack spacing:

$$s_{r,max} = if \left\{ s \leq 5 \left(c + \frac{\phi}{2} \right), k_3 c + \frac{k_1 k_2 k_4 \phi}{\rho_{p,eff}}, 1.3(h - x) \right\}$$

where $k_3 = 3.4$, and $k_4 = 0.425$

Cracking strain showing tension stiffening component in square brackets:

$$\varepsilon_{sm} - \varepsilon_{cm} = \frac{\sigma_s - k_t f_{ct,eff} \alpha_e}{E_s} - \left[\frac{k_t \frac{f_{ct,eff}}{\rho_{p,eff}}}{E_s} \right]$$

The mean value of the tensile strength of the concrete effective at the time when cracks may be first expected to occur:

$$f_{ct,eff} = f_{ctm} = \text{if} \left\{ f_{ck} \leq 60, 0.259 f_{ck}^{2/3}, 2.27 \ln \left(1 + \frac{f_{cm}}{12.5} \right) \right\}$$

Crack widths:

$$w_k = s_{r,max} (\varepsilon_{sm} - \varepsilon_{cm})$$

Viewing SLS results

See [RC Slab Design : Viewing Results](#) for details of plotting SLS reinforcement design contours.

Design Code Settings and Parameters for India (IRS:CBC-1997)

Selecting **India** and the IRS:CBC-1997 design code options on the main Design Code Settings page on the RC Slab Design: Design Code Settings dialog allows calculations, and offers defaults, based on:

- IRS:CBC-1997**, IRS Concrete Bridge Code 1997, Incorporating A & C slip no 7, 2003. Indian Railway Standard, Code of Practice for Plain, Reinforced and Prestressed Concrete for General Bridge Construction Research Designs and Standards Organisation

Note that regardless of model units, units in keeping with the design code stated are used, i.e. Mpa, millimetres etc., as shown on the dialog

RC Slab Design: Design Code Settings

Design code

Country: India

Design code: IRS:CBC-1997

Design calculations

ULS section design: Bending and in-plane forces (Clark-Nielsen)

SLS crack checking: Bending and in-plane forces (Principal stresses)

Design parameters

Characteristic concrete cube strength (f_{cu}): 40.0 N/mm²

Characteristic strength of reinforcement (f_y): 460.0 N/mm²

Defaults < Back Next > Finish Cancel Help

General Settings

See [RC Slab Design : Design Code Settings](#) for details.

Design Parameters

The following parameters are required:

- ❑ **Characteristic concrete cube strength, f_{cu}** When ULS reinforcement design is selected, f_{cu} is used in the calculation of the lever arm, z , and in determining if the section is tension-controlled. When SLS crack checking is selected, the elastic modulus for concrete is determined using this value in the absence of specific user input for that parameter. Typical values lie in the range 20 to 60N/mm². The default is 40N/mm²
- ❑ **Characteristic strength of reinforcement, f_y** When ULS reinforcement design is selected f_y is used in the calculation of the area of reinforcing steel required (and bar diameters) and in determining if the section is tension-controlled. It is not used for SLS crack checking calculations. Typical values would be $f_y=250, 460$ or 485N/mm². The default is 460N/mm².

Reinforcement Details

See [RC Slab Design Attribute](#) for how to specify reinforcement arrangements. India IRS:CBC-1997-specific information is provided here:

- ❑ **Bar sizes** Nominal diameters (and cross-sectional areas).
- ❑ **Spacing** [s] Typical values lie in the range 25mm to 300mm with a typical aggregate size of 20mm. The default is 150mm.
- ❑ **Cover** [c_{act}] This is the cover used to calculate effective depths, as distinct from nominal cover (c_{nom}), used in the calculation of crack widths (see below). For various reasons, including durability considerations or fixing tolerances, the specified c_{act} may be greater than c_{nom} . Typical values for c_{act} would, however, lie in the range 20 to 75mm.
- ❑ **Nominal Cover** (used in crack width calculations) [c_{nom}] This value affects the design crack width calculation by changing the location at which the design crack width is assessed. In essence, the crack width is calculated at a plane lying a distance, c_{nom} , from the layer of bars controlling the crack. Typical values lie in the range 25 to 75mm and should be determined from IRS:CBC-1997 clause 15.9.2.2.

ULS Reinforcement Design

See [Background to Calculations Carried out by the Slab Designer](#) for general information.

For nominal resistance calculations IRS:CBC-1997 clause 15.4.2.2.1 is used.

Area of steel required

The formulae can be summarized as follows:

$$A_{s,req} = \frac{M_u}{0.87f_y z}$$

$$z = \left(1 - \frac{1.1f_y A_{s,prov}}{f_{cu} b d} \right) d \geq 0.95d$$

The nomenclature used above is as in the relevant codes excepting that:

$A_{s,req}$ = Area of tension reinforcement required

$A_{s,prov}$ = Area of tension reinforcement provided

Tension control ratio

The slab is ductile when the inequality below is met:

$$\frac{M_u / b d^2 f_{cu}}{0.15} \leq 1$$

Viewing ULS results

See [RC Slab Design : Viewing Results](#) for details of plotting ULS reinforcement design contours.

Crack Width parameters

The Crack Width Settings page is shown if the Next button is pressed on the Design Code Settings dialog.

RC Slab Design: Crack Width Settings

Calculation properties

Allowable crack width (mm)

Tension stiffening

Include Ignore Interpolate

Elastic moduli

Use code defined values

User defined values

Short term modulus concrete kN/mm²

Long term modulus of concrete kN/mm²

Modulus of steel kN/mm²

Loading ratio

All live loads

Fixed proportion

Short term moments:Total moments (%)

Long term moments:Total moments (%)

Calculated proportion

Long term moments from loadcase or combination

The short term moments are taken from the currently active loadcase. Crack widths are based on the summed moments from the designated (long term) and active (short term) loadcases

Defaults < Back Next > Finish Cancel Help

Calculation properties

- **Allowable crack width (mm)** The value entered is only used to calculate the crack width utilisations. IRS:CBC-1997 Table 10 relates design crack width requirements to exposure conditions, with values from 0.1mm to 0.3mm. The default value is taken as 0.2mm.

Tension stiffening

IRS:CBC-1997 cl 15.9.8.2.1 shows an equation which includes a reduction in the calculated crack width in consideration of the stiffening effect of tension carried by concrete which remains bonded to the reinforcement in the tensile zone at small strains. As described in SLS crack checking where reinforcement does not lie perpendicular to cracks, whether the “tension stiffening” reduction should be included

is a matter of debate. The Slab Designer offers three options for crack check calculations:

- Include** Considers tension stiffening for all angles
- Ignore** Tension stiffening is completely ignored for conservative design.
- Interpolate** (Default option) Scales linearly from 0% tension stiffening at $\alpha=25^\circ$, to 100% at $\alpha=0^\circ$.

Elastic Moduli

The elastic moduli for concrete and reinforcing steel are used in calculation of flexural strains in the slab, leading to the calculation of a design crack width.

- Use code defined values** When this option is invoked, the moduli used in calculations (as required), will be as stated in the table below.
- User defined values** When this option is invoked, users may enter values for elastic moduli instead of using those determined automatically.

Long term modulus for concrete	Elastic modulus for steel
$m = 280/f_{ck}$	200kN/mm ²

Loading Ratio

In the calculation of crack widths, strains are assessed using an effective elastic modulus for concrete. This effective modulus may be calculated in a number of ways to suit the user and code of practice as follows:

- All live loads** This assumption is conservative in consideration of Clause 5.2.6. This is the default option.
- Fixed proportion** The effective elastic modulus for concrete is calculated using a ratio, R, of moments due to live loading (M_q) to total moments, (M_g+M_q). R is entered by the user as a percentage and the following expression (based on strain compatibility) is used to determine the effective modulus:

$$E_{c,eff} = \frac{E_{c,short} \times E_{c,long}}{E_{c,long} R + E_{c,short} (1 - R)}$$

Assuming a suitable single value for R can be determined by the user, this option suits the approach of clause 5.2.6 when $E_{c,long} = E_{c,short}/2$, i.e. when “use code defined values” is selected.

- Calculated proportion** The effective elastic modulus for concrete is calculated using the ratio, R, as described above. In this case, however, R is evaluated at each node. The moments due to permanent loads, M_g , are taken from the loadcase selected in the droplist. The moments due to live loads, M_q , are taken from the active loadcase. The ratio at each node is:

$$R = \frac{M_q}{M_g + M_q}$$

Consistent with the above expression, total moments used for the calculation of crack width are based on $M_g + M_q$. This option suits the approach of clause 5.2.6 when $E_{c,long} = E_{c,short}/2$ i.e. when “use code defined values” is selected. The need for a suitable single value for R to be determined by the user is avoided.

SLS crack width calculation

See [Background to Calculations Carried out by the Slab Designer](#) for general information.

Crack width calculations are carried out by reference to IRS:CBC-1997 clause 15.9.8.2.1 as follows:

IRS:CBC-1997

$$\epsilon_s = \frac{M}{E_s A_s \left(d - \frac{x}{3}\right)}$$
$$\epsilon_1 = \frac{\epsilon_s (a' - x)}{(d - x)}$$

Reduction due to strain stiffening

$$\epsilon_2 = \left[\frac{3.8 b_t h (a' - d_c)}{\epsilon_s A_s (h - d_c)} \right] \left[\left(1 - \frac{M_q}{M_g} \right) 10^{-9} \right]$$

Strain at cracking level

$$\epsilon_m = \epsilon_1 - \epsilon_2$$

Distance to controlling bar

$$a_{cr} = \sqrt{(h - d)^2 + (s/2)^2} - \phi/2$$

Crack widths

$$w = \frac{3a_{cr}\epsilon_m}{1 + 2\left(\frac{a_{cr} - c_{nom}}{h - d_c}\right)}$$

The spacing and bar diameter of the bars identified as “controlling” the crack are used to determine the distance from the crack to the nearest bar, a_{cr} .

Viewing SLS results

See [RC Slab Design : Viewing Results](#) for details of plotting SLS reinforcement design contours.

Design Code Settings and Parameters for Singapore (Eurocode / CP65-1999)

Selecting **Singapore** and one of the design code options on the main Design Code Settings page on the RC Slab Design: Design Code Settings dialog allows calculations, and offers defaults, based on either:

- SS CP65-1999** Code of Practice for Structural Use of Concrete
- SS EN1992-1-1/NA 2008 inc Amd 1** Design of Concrete Structures (buildings)

Note that, regardless of model units, units in keeping with the design code stated are used, i.e. N/mm², millimetres etc., as shown on the dialog.

RC Slab Design: Design Code Settings

Design code

Country: Singapore

Design code: SS CP65-1999

Design calculations

ULS section design: Bending and in-plane forces (Clark-Nielsen)

SLS crack checking: Bending and in-plane forces (Principal stresses)

Design parameters

Characteristic concrete cube strength (f_{cu}): 40.0 N/mm²

Characteristic strength of reinforcement (f_y): 460.0 N/mm²

Defaults < Back Next > Finish Cancel Help

General Settings

See [RC Slab Design : Design Code Settings](#) for details.

Design Parameters

For SS EN1992-1-1/NA 2008 inc Amd 1 see [RC Slab Design : Design Code Settings and Parameters for Eurocode](#)

For SS CP65-1999 the following parameters are required:

- ❑ **Characteristic concrete cube strength, f_{cu}** For ULS section design f_{cu} is used in the calculation of the lever arm, z , and in determining if the section is tension-controlled. For SLS crack checking, the elastic modulus for concrete is determined using this value in the absence of specific user input for that parameter. Typical values lie in the range 20 to 60N/mm². The default is 40N/mm²
- ❑ **Characteristic strength of reinforcement, f_y** For ULS section design f_y is used in the calculation of the area of reinforcing steel required (and bar diameters) and in determining if the section is tension-controlled. It is not used for SLS crack checking calculations. Typical values would be $f_y=250, 460$ or 485N/mm². The default is 460N/mm².

Reinforcement Details

See [RC Slab Design Attribute](#) for how to specify reinforcement arrangements. Singapore CP65-1999 related information is shown here:

- ❑ **Bar sizes** Nominal diameters (and cross-sectional areas) .
- ❑ **Spacing** [s] Typical values lie in the range 25mm to 300mm, (with a typical aggregate size of 20mm). The default is 150mm.
- ❑ **Cover** [c_{act}] This is the cover used to calculate effective depths, as distinct from nominal cover (c_{nom}), used in the calculation of crack widths (see below). For various reasons, including durability considerations or fixing tolerances, the specified c_{act} may be greater than c_{nom} . Typical values for c_{act} would, however, lie in the range 20 to 75mm (CP65 clause 3.3).
- ❑ **Nominal Cover**(used in crack width calculations) [c_{nom}] This value affects the design crack width calculation by changing the location at which the design crack width is assessed. In essence, the crack width is calculated at a plane lying a distance, c_{nom} , from the layer of bars controlling the crack. For CP65-1999 it may be assumed that c_{nom} is equal to the actual cover, c_{act} , making the crack width plane described coincident with the tension face of the concrete. Typical values lie in the range 20 to 70mm and should be determined from CP65 clause 3.3.

ULS Reinforcement Design to CP65-1999

See [Background to Calculations Carried out by the Slab Designer](#) for general information.

The formulae are according to CP65 clause 3.4.4.4 (as referenced from clause 3.5.1 regarding slabs).

Area of steel required

The formulae used are summarized below:

CP65

$$A_{s,req} = \frac{M_d}{0.87f_y z}$$

$$z = d \left\{ 0.5 + \sqrt{0.25 - \frac{K}{0.9}} \right\} \geq 0.95d$$

$$K = \frac{M}{bd^2 f_{cu}}$$

Where:

$A_{s,req}$ = Area of tension reinforcement required

Tension control ratio

The slab is ductile when the appropriate inequality below is met:

$$\frac{K}{K'} = \frac{K}{0.156} \leq 1$$

Viewing ULS results

See [RC Slab Design : Viewing Results](#) for details of plotting ULS reinforcement design contours.

Crack Width parameters for CP65-1999

For SS EN1992-1-1/NA 2008 inc Amd 1 see [RC Slab Design : Design Code Settings and Parameters for Eurocode](#)

The Crack Width Settings page is shown if the Next button is pressed on the Design Code Settings dialog.

Calculation properties

- Allowable crack width (mm)** For CP65-1999 the value is used to the scale the crack width contours. Clause 3.12.11.2 indicates a limitation of 0.3mm. The default value is taken as 0.2mm

Tension stiffening

CP65-Part 2-1999 cl 3.8.3, eqn 13, includes a reduction in the calculated crack width in consideration of the stiffening effect of tension carried by concrete which remains bonded to the reinforcement in the tensile zone at small strains. As described in SLS crack checking where reinforcement does not lie perpendicular to cracks, whether the “tension stiffening” reduction should be included is a matter of debate. The Slab Designer offers three options for crack check calculations:

- Include** Considers tension stiffening for all angles
- Ignore** Tension stiffening is completely ignored for conservative design.
- Interpolate** (Default option) Scales linearly from 0% tension stiffening at $\alpha=25^\circ$, to 100% at $\alpha=0^\circ$.

Elastic Moduli

The elastic moduli for concrete and reinforcing steel are used in calculation of flexural strains in the slab, leading to the calculation of a design crack width.

- ❑ **Use code defined values** When this option is invoked, the moduli used in calculations (as required), will be as stated in the table below.
- ❑ **User defined values** When this option is invoked, users may enter values for elastic moduli instead of using those determined automatically. The default values are based on the values and expressions described previously.

Short term modulus for concrete	Long term modulus for concrete	Elastic modulus for steel
$E_{c,short} = 0.2 \times f_{cu} + 20$	$E_{c,long} = E_{c,short} / 2$	200kN/mm ²
CP65-Part 2 1999 eqn 17, clause 7.2	BS5400-4 clause 4.3.2.1 (see note 1)	CP65-1999 clause 2.5.4

Notes

- The reference to BS5400-4 is for an approximation taking into account the effect of creep under long term loading, since reference to CP65-Part 2 1999 clause 3.6(a)(3) requires determination of a creep coefficient. This approximation is broadly validated with reference to CIRIA Report 110.

Calculate Effective Elastic Modulus for Concrete

In the calculation of crack widths, strains are assessed using an effective elastic modulus for concrete. This effective modulus may be calculated in a number of ways to suit the user and code of practice as follows:

- ❑ **Half the instantaneous value** The effective elastic modulus for concrete is taken as half the instantaneous value, as per BS8110-2 clause 3.8.3. This is the default option.
- ❑ **Interpolated, based on proportion** The effective elastic modulus for concrete is calculated using a ratio, R, of moments due to live loading (M_q) to total moments, ($M_g + M_q$). R is entered by the user as a percentage and the following expression (based on strain compatibility) is used to determine the effective modulus:

$$E_{c,eff} = \frac{E_{c,short} \times E_{c,long}}{E_{c,long}R + E_{c,short}(1 - R)}$$

- ❑ **Interpolated, based on calculated proportion** The effective elastic modulus for concrete is calculated using the ratio, R, as described above. In this case, however, R is evaluated at each node. The moments due to permanent loads, M_g , are taken from the loadcase selected in the droplist. The moments due to live loads, M_q , are taken from the active loadcase. The ratio at each node is:

$$R = \frac{M_q}{M_g + M_q}$$

Consistent with the above expression, total moments used for the calculation of crack width are based on $M_g + M_q$.

SLS crack width calculation to CP65-1999

See [Background to Calculations Carried out by the Slab Designer](#) for general information.

Crack width calculations are carried out by reference to CP65-Part 2 clause 3.8.3 and may be summarised as follows:

CP65

$$\epsilon_s = \frac{M}{E_s A_s \left(d - \frac{x}{3}\right)}$$

$$\epsilon_1 = \frac{\epsilon_s (a' - x)}{(d - x)}$$

Reduction due to strain stiffening

$$\epsilon_2 = \frac{b_t (h - x) (a' - x)}{3 E_s A_s (d - x)}$$

Strain at cracking level

$$\epsilon_m = \epsilon_1 - \epsilon_2$$

Distance to controlling bar

$$a_{cr} = \sqrt{(h - d)^2 + (s/2)^2} - \phi/2$$

Crack widths

$$w = \frac{3a_{cr}\epsilon_m}{1 + 2\left(\frac{a_{cr} - c_{min}}{h - x}\right)}$$

The spacing and bar diameter of the bars identified as “controlling” the crack are used to determine the distance from the crack to the nearest bar, a_{cr} .

Viewing SLS results

See [RC Slab Design : Viewing Results](#) for details of plotting SLS reinforcement design contours.

Design Code Settings and Parameters for UK (Eurocode / British Standards)

Selecting **United Kingdom** and one of Eurocode or British Standard design code options on the RC Slab Design: Design Code Settings dialog allows calculations, and offers defaults, based on the appropriate BS publication below:

- BS EN1992-1-1:2004/NA:2005**, Design of Concrete Structures - general rules and rules for buildings
- BS EN1992-2:2005/NA:2007**, Design of Concrete Structures - concrete bridges - Design and detailing rules
- BS 8110-1:1997 & BS8110-2:1985**, Structural use of Concrete. Code of practice for design and construction, and for special circumstances
- BS 8007:1987**, Code of practice for design of concrete structures for retaining aqueous liquids
- BS 5400-4: 1990**, Steel, concrete and composite bridges – Part 4: Code of practice for design of concrete bridges

Note that regardless of model units, units in keeping with the design code stated are used, i.e. N/mm², millimetres etc., as shown on the dialog.

RC Slab Design: Design Code Settings

Design code

Country: United Kingdom

Design code: BS EN 1992-1-1:2004/NA:2005

Design calculations

ULS section design: Bending only (Wood-Armer)

SLS crack checking: Bending only (Principal moments)

Design parameters

Characteristic yield strength of reinforcement (f_{yk}): 500.0 MPa

Material factor for reinforcing steel (γ_s): 1.15

Modulus of elasticity of reinforcing steel (E_s): 200.0 GPa

Characteristic cylinder strength of concrete (f_{ck}): 40.0 MPa

Material factor for concrete (γ_c): 1.5

Coefficient for long term and unfavorable effects (α_{cc}): 0.85

Defaults < Back Next > Finish Cancel Help

General Settings

See [RC Slab Design : Design Code Settings](#) for details.

Design Parameters

For BS EN1992-1-1:2004/NA:2005 and BS EN1992-2:2005/NA:2007 see [RC Slab Design : Design Code Settings and Parameters for Eurocode](#)

For BS8110–1:1997 & BS8110–2:1985, BS8007:1987, and BS5400-4: 1990 the following parameters are required:

- Characteristic concrete cube strength, f_{cu}** When ULS section design is selected, f_{cu} is used in the calculation of the lever arm, z , and in determining if the section is tension-controlled. For SLS crack checking the elastic modulus for concrete is determined using this value in the absence of specific user input for that parameter. Typical values lie in the range 20 to 60N/mm². The default is 40N/mm²
- Characteristic strength of reinforcement, f_y** For ULS section design f_y is used in the calculation of the area of reinforcing steel required (and bar diameters) and in determining if the section is tension-controlled. It is not used for SLS crack checking calculations. Typical values would be $f_y=250, 460$ or

485N/mm² (see BS8110-1 Table 3.1 and BS5400-4 Table 6) and the default is 460N/mm².

Reinforcement Details

See [RC Slab Design Attribute](#) for how to specify reinforcement arrangements. Eurocode / BS-specific information is provided here:

- ❑ **Bar sizes** Nominal diameters (and cross-sectional areas) correspond to those in BS4449 Table 7.
- ❑ **Spacing** [s] Typical values lie in the range 25mm to 300mm (BS8110-1 clause 3.12.11 and BS5400-4 clause 5.8.8, with a typical aggregate size of 20mm). The default is 150mm.
- ❑ **Cover** [c_{act}] This is the cover used to calculate effective depths, as distinct from nominal cover (c_{nom}), used in the calculation of crack widths (see below). For various reasons, including durability considerations or fixing tolerances, the specified c_{act} may be greater than c_{nom} . Typical values for c_{act} would, however, lie in the range 20 to 75mm (BS8110-1 clause 3.3, BS5400-4 Table 13 and BD57/01 clause 3.1). The default is 50mm.
- ❑ **Nominal cover** (used in crack width calculations) [c_{nom}] This value affects the design crack width calculation by changing the location at which the design crack width is assessed. In essence, the crack width is calculated at a plane lying a distance, c_{nom} , from the layer of bars controlling the crack. When using BS8110-2, it may be assumed that c_{nom} is equal to the actual cover, c_{act} , making the crack width plane described coincident with the tension face of the concrete. When using BS5400-4 in conjunction with BD57/01 clause 3.1, however, $c_{act} = c_{nom} + 10\text{mm}$, and therefore the crack width plane is internal to the concrete, also see BA57/01 clause 5.2. The value entered here should therefore be the nominal cover, c_{nom} to be used in crack width calculations – whether this is identical to, or less than, c_{act} . Typical values lie in the range 20 to 70mm and should be determined from BS8110-1 clause 3.3, Tables 3.3 and 3.4, BS8007 clause 2.7.6 or BS5400-4 Table 13 and clause 5.8.2 as appropriate. The default is 40mm.

ULS Reinforcement Design to British Standards

See [Background to Calculations Carried out by the Slab Designer](#) for general information.

British Standard-specific assumptions for nominal resistance calculations are:

The formulae are according to BS8110-1 clause 3.4.4.4 (as referenced from clause 3.5.1 regarding slabs). BS8007 clauses 2.2.1 and 3.2.1 indicate that ULS moment checks are determined according to BS8110-1 and BS8007 does not amend the method of BS8110-1 in this regard. For bridges, BS5400-4 clause 5.3.2.3 (as referenced from clause 5.4.2 regarding slabs) is used.

Area of steel required

The formulae used are summarised below.

BS8110	BS5400-4
$A_s = \frac{M}{0.95f_y z}$	$A_{s,req} = \frac{M_u}{0.87f_y z}$
$z = d \left\{ 0.5 + \sqrt{0.25 - \frac{K}{0.9}} \right\} \geq 0.95d$	$z = \left(1 - \frac{1.1f_y A_{s,prov}}{f_{cu} b d} \right) d \geq 0.95d$
$K = \frac{M}{b d^2 f_{cu}}$	

The nomenclature used above is as in the relevant codes excepting that:

$A_{s,req}$ = Area of tension reinforcement required

$A_{s,prov}$ = Area of tension reinforcement provided

Tension control ratio

The slab is ductile when the appropriate inequality below is met:

BS8110	BS5400-4
$\frac{K}{K'} = \frac{K}{0.156} \leq 1$	$\frac{M_u / b d^2 f_{cu}}{0.15} \leq 1$

Viewing ULS results

See [RC Slab Design : Viewing Results](#) for details of plotting ULS reinforcement design contours.

Crack Width parameters

The Crack Width Settings page of the RC Slab Designer will appear only if the chosen design code supports crack width calculations.

Settings for the British Standards options (non-Eurocodes) are described here.

For BS EN1992-1-1:2004/NA:2005 and BS EN1992-2:2005/NA:2007 see [RC Slab Design : Design Code Settings and Parameters for Eurocode](#)

Calculation properties

- Allowable crack width (mm) When using BS8007, this value will determine which expression from BS8007 Appendix B is used for the calculation of design crack width. It will also be used to scale the crack width contours, and is also used to determine the crack width utilisation contours. When using either BS8110 or BS5400, the value entered is only used to calculate crack width utilisation. Additionally, BS8007 clause 2.2.3.3(a) requires the allowable crack width to be set as either 0.1 or 0.2mm. BS8110-1 clause 3.12.11.2 indicates a limitation of 0.3mm, while BS5400-4 Table 1 relates design crack width requirements to exposure conditions, with values from 0.1mm to 0.25mm. The default value is taken as 0.2mm.

Tension stiffening

BS8110-2 cl 3.8.3, eq. 13, BS8007 Appendix B clause B.4 and BS5400-4 cl 5.8.8.2 eqn 25 include a reduction in the calculated crack width due to the stiffening effect of tension carried by concrete which remains bonded to the reinforcement in the tensile zone at small strains. Where reinforcement does not lie perpendicular to cracks, whether the “tension stiffening” reduction should be included is a matter of debate (see SLS Crack Checking in [Background to Slab Designer Calculations](#)). The Slab Designer offers three options for crack check calculations:

- Include** Considers tension stiffening for all angles

- Ignore** Tension stiffening is completely ignored for conservative design.
- Interpolate** (Default option) Scales linearly from 0% tension stiffening at $\alpha=25^\circ$, to 100% at $\alpha=0^\circ$.

Elastic Moduli

The elastic moduli for concrete and reinforcing steel are used in calculation of flexural strains in the slab, leading to the calculation of a design crack width.

- Use code defined values** When this option is invoked, the moduli used in calculations (as required), will be as stated in the table below.
- User defined values** When this option is invoked, users may enter values for elastic moduli instead of using those determined automatically. The default values are based on the values and expressions in the codes of practice described previously.

Design code	Short term modulus for concrete	Long term modulus for concrete	Elastic modulus for steel
BS8110	$E_{c,short} = 0.2 \times f_{cu} + 20$ BS8110-2 eqn 17, clause 7.2	$E_{c,long} = E_{c,short}/2$ BS5400-4 clause 4.3.2.1 (see note 1)	200kN/mm ² BS8110-1 clause 2.5.4
BS8007		As for BS8110 BS8007 clause 2.2.1	
BS5400-4	$E_{c,short} = 0.27 \times f_{cu} + 20$ BD44/95 (see note 2)	$E_{c,long} = E_{c,short}/2$ BS5400-4	200kN/mm ² BS5400-4

Notes

1. The reference to BS5400-4 is for an approximation taking into account the effect of creep under long term loading, since reference to BS8110-2 clause 3.6(a)(3) requires determination of a creep coefficient. This approximation is broadly validated with reference to CIRIA Report 110.
2. This equation (rounded to 2 significant figures) closely approximates BS5400-4 Table 3 although the value for $f_{cu}=25\text{N/mm}^2$ is calculated as $E_c=27\text{kN/mm}^2$ instead of 26kN/mm^2 as given in Table 3. Use of the equation

is felt preferable as it is more flexible for values of f_{cu} other than those given in Table 3.

Calculate Effective Elastic Modulus for Concrete

In the calculation of crack widths, strains are assessed using an effective elastic modulus for concrete. This effective modulus may be calculated in a number of ways to suit the user and code of practice as follows:

- ❑ **Half the instantaneous value** The effective elastic modulus for concrete is taken as half the instantaneous value, as per BS8110-2 clause 3.8.3. This assumption is also conservative in consideration of BS5400-4 clause 4.3.2.1. This is the default option.
- ❑ **Interpolated, based on proportion** The effective elastic modulus for concrete is calculated using a ratio, R , of moments due to live loading (M_q) to total moments, ($M_g + M_q$). R is entered by the user as a percentage and the following expression (based on strain compatibility) is used to determine the effective modulus:

$$E_{c,eff} = \frac{E_{c,short} \times E_{c,long}}{E_{c,long}R + E_{c,short}(1 - R)}$$

Assuming a suitable single value for R can be determined by the user, this option suits the approach of BS5400-4 clause 4.3.2.1(b) when $E_{c,long} = E_{c,short}/2$, i.e. when “use code defined values” is selected.

- ❑ **Interpolated, based on calculated proportion** The effective elastic modulus for concrete is calculated using the ratio, R , as described above. In this case, however, R is evaluated at each node. The moments due to permanent loads, M_g , are taken from the loadcase selected in the droplist. The moments due to live loads, M_q , are taken from the active loadcase. The ratio at each node is:

$$R = \frac{M_q}{M_g + M_q}$$

Consistent with the above expression, total moments used for the calculation of crack width are based on $M_g + M_q$. This option suits the approach of BS5400-4 clause 4.3.2.1(b) when $E_{c,long} = E_{c,short}/2$ i.e. when “use code defined values” is selected. The need for a suitable single value for R to be determined by the user is avoided.

SLS crack width calculation to British Standards

See [Background to Calculations Carried out by the Slab Designer](#) for general information.

Crack width calculations for the British Standards are carried out by reference to BS8110-2 clause 3.8.3 and BS5400-4 clause 5.8.2(a) and may be summarised (with differences shown) as follows:

BS8110	BS5400-1
$\epsilon_s = \frac{M}{E_s A_s \left(d - \frac{x}{3}\right)}$ $\epsilon_1 = \frac{\epsilon_s (a' - x)}{(d - x)}$	

Reduction due to strain stiffening

$$\epsilon_2 = \frac{b_t (h - x) (a' - x)}{3 E_s A_s (d - x)} \quad \epsilon_2 = \left[\frac{3.8 b_t h (a' - d_c)}{\epsilon_s A_s (h - d_c)} \right] \left[\left(1 - \frac{M}{M_{cr}} \right) \right]$$

Strain at cracking level

$$\epsilon_m = \epsilon_1 - \epsilon_2$$

Distance to controlling bar

$$a_{cr} = \sqrt{(h - d)^2 + (s/2)^2} - \phi/2$$

Crack widths

$$w = \frac{3 a_{cr} \epsilon_m}{1 + 2 \left(\frac{a_{cr} - c_{min}}{h - x} \right)} \quad w = \frac{3 a_{cr} \epsilon_m}{1 + 2 \left(\frac{a_{cr} - c_{nom}}{h - d_c} \right)}$$

The spacing and bar diameter of the bars identified as “controlling” the crack are used to determine the distance from the crack to the nearest bar, a_{cr} .

From BS8007 clauses B.2 to B.4, flexural cracks are calculated as for BS8110-2, except that ϵ_2 is given as:

$$\epsilon_2 = \frac{b_t(h-x)(a'-x)}{3E_s A_s (d-x)} \text{ for crack width limit of 0.2mm}$$

$$\epsilon_2 = \frac{1.5b_t(h-x)(a'-x)}{3E_s A_s (d-x)} \text{ for crack width limit of 0.1mm}$$

Viewing SLS results

See [RC Slab Design : Viewing Results](#) for details of plotting SLS crack checking / reinforcement design contours.

Design Code Settings and Parameters for AASHTO LRFD

Selecting **United States of America** and one of the design code options on the RC Slab Design : Design Code Settings dialog allows calculations, and offers defaults, based on the appropriate publication below:

- AASHTO LRFD Bridge Design Specifications, 7th Edition**, American Association of State Highway and Transportation Officials, 2014
- AASHTO LRFD Bridge Design Specifications, 6th Edition**, American Association of State Highway and Transportation Officials, 2012
- AASHTO LRFD Bridge Design Specifications, 5th Edition**, American Association of State Highway and Transportation Officials, 2010

Note that regardless of model units, units in keeping with the design code stated are used, i.e. ksi, inches etc., as shown on the dialog.

RC Slab Design: Design Code Settings

Design code

Country: United States of America

Design code: AASHTO LRFD 7th Edition (2014)

Design calculations

ULS section design: Bending only (Wood-Armer)

SLS crack checking: Bending only (Principal moments)

Design parameters

Specified compressive strength of concrete for use in design (f'_c): 6.0 ksi

Specified yield strength of reinforcing bars (f_y): 75.0 ksi

Resistance factor for tension controlled reinforced concrete sections (ϕ): 0.9

Defaults < Back Next > Finish Cancel Help

General Settings

See [RC Slab Design : Design Code Settings](#) for details.

Design Calculations

ULS reinforcement design is catered for but SLS crack checking is not available. This is because AASHTO LRFD requirements do not include a crack width calculation, instead relying on minimum reinforcement requirements (clause 5.7.3.3.2) and maximum spacing of reinforcing bars (clause 5.7.3.4).

Design Parameters

- Specified compressive strength of concrete for use in design, f'_c .** Typical values lie in the range 2.4 to 10.0ksi (clause 5.4.2.1 and Table C5.4.2.1-1). The default is 6.0ksi (41MPa).
- Specified yield strength of reinforcing bars, f_y .** For AASHTO 5th and AASHTO 6th typical values lie in the range 60 to 75ksi (clauses 5.4.3.1 and 9.7.2.5). For AASHTO 7th yield strengths of between 75 and 100ksi are permitted in Seismic zone 1. The default value provided is 75ksi.
- Resistance factor for tension controlled reinforced concrete sections ϕ .** According to clause 5.5.4.2.1, $\phi=0.9$ for tension controlled reinforced concrete sections, and this is the default value. This value will be used for all slab

sections, and hence users should verify whether a variation is required for sections that are not tension-controlled, as per Figure C5.5.4.2.1-1. Tension control ratios are output and also a warning message is issued for sections not tension-controlled.

Reinforcement Details

See [RC Slab Design Attribute](#) for how to specify reinforcement arrangements. AASHTO-specific advice is provided here:

- Bar sizes** Imperial bar designations are used as shown in the table. The default size is #6.
- Spacing [s]** Typical values lie in the range 2” to 12” (from practical considerations and clause 5.7.3.4, although clause 9.7.2.5 suggests 18” as a maximum). The default is 6” (approximately 150mm)
- Cover [d_c]** Typical values lie in the range 0.8” to 4” (from Table 5.12.3-1). The default is 2” (approximately 50mm)

Bar Designations

Bar size	Bar Size Nominal Diameter (inches)
#3	0.375 = $\frac{3}{8}$
#4	0.500 = $\frac{1}{2}$
#5	0.625 = $\frac{5}{8}$
#6	0.750 = $\frac{3}{4}$
#7	0.875 = $\frac{7}{8}$
#8	1
#9	1.128
#10	1.27
#11	1.41
#14	1.693
#18	2.257
#18J	2.337

ULS Reinforcement Design to AASHTO

See [RC Slab Design : Viewing Results](#) for details of plotting ULS reinforcement design contours.

See [Background to Calculations Carried out by the Slab Designer](#) for general information.

AASHTO-specific assumptions for nominal resistance calculations are:

- Tensile strength of concrete is neglected, as per clause 5.7.2.1
- A rectangular stress block of $0.85f'_c$ is assumed (see clause 5.7.2.2 and eq 5.7.3.1.1-4 in the absence of prestressing steel)
- For AASHTO 5th and AASHTO 6th f_y replaces f_s on the assumption that $c/d_s \leq 0.6$, as per clause 5.7.2.1 and a warning occurs if this inequality does not hold at any location on the slab.
- For AASHTO 7th f_y replaces f_s on the assumption that $c/d_s \leq 0.003/(0.003 + \epsilon_{ci})$, i.e. the section is not compression-controlled. This inequality holds true for sections that are either tension-controlled or in the transition region. However a warning will be issued for all sections that are not tension-controlled, even if in the transition region, which is conservative.

Area of steel required

On the above basis, the formulae used can be summarised as:

AASHTO LRFD

$$A_{s,req} = \frac{M_u}{\phi f_y z}$$

$$z = d_s - \frac{\beta_1 c}{2}$$

$$c = \frac{f_y A_{s,prov}}{0.85 f'_c \beta_1 b}$$

$$\beta_1 = \text{if} \left\{ f'_c < 4, 0.85, \max \left(0.85 - \frac{f'_c - 4}{20}, 0.65 \right) \right\}$$

The nomenclature used above is as in AASHTO LRFD, plus:

$A_{s,req}$ = Area of reinforcing steel required

$A_{s,prov}$ = Area of reinforcing steel provided

Tension control ratio

For the slab to be regarded as tension-controlled (ductile), the following inequality must be met, i.e. the tension control ratio must be less than 1. etl is typically 0.005, but varies for steel grades > 75ksi, according to Table C5.7.2.1-1.

$$\frac{0.005c}{0.003(d_s - c)} \leq 1$$

Viewing results

See [RC Slab Design : Viewing Results](#) for details of plotting ULS reinforcement design contours.

Background to RC Slab Design Calculations

ULS reinforcement design

Bending only (Principal moments)

Where a reinforced concrete slab is subject to a general set of bending and twisting moments (M_x , M_y , M_{xy}), these must be rationalised into components which can be used to design the 4 layers of reinforcement – top and bottom, X and Y directions. The method used here is that attributed to Wood & Armer (1969), which optimises the reinforcement requirements based on total weight of reinforcement.

Codes of Practice generally set out principles or rules in terms of the flexural resistance of beams. In accordance with industry practice, the Slab Designer uses these rules together with Wood-Armer moments to determine ULS reinforcement requirements. To prevent excessive compression in the concrete, due to the combined effect of moments in orthogonal directions, Cope & Clark (1984) recommend that slabs are “tension controlled” (sometimes termed “under-reinforced”), i.e. the resistance of the section should be controlled by yielding of the tensile reinforcement rather than crushing of the concrete. Adding compression steel is advised against, and accordingly the RC Slab Design facility assumes that all reinforcement specified is tensile.

The RC Slab Design facility in LUSAS enables users to check that the slab is tension-controlled, by use of the appropriate contour option. The plot is based on a ratio, the specifics of which are detailed according to the Code of Practice, calculated at each node. If the slab is not “tension-controlled”, reinforcement calculations may be unconservatively inaccurate.

Bending and in-plane forces (Clark-Nielsen)

ULS design with in-plane forces uses the Clark-Nielsen forces for checking reinforcement requirements. For each assigned slab attribute the Clark-Nielsen forces are calculated based on lever arms between the layers of the slab reinforcement.

SLS crack checking

Bending only (Wood-Armer)

Where a reinforced concrete slab is subject to a general set of bending and twisting moments, it may be reasonably assumed that tensile cracks will form perpendicular to the directions of principal moments.

Codes of Practice generally set out principles or rules in terms of cracking in beams, where, by nature, the principal moments are aligned with the direction of the reinforcement. Such methods can, however, be applied to slabs (where the principal moments may not coincide with the reinforcement directions), with the crack assumed perpendicular to the principal moment direction, using an equivalent area of reinforcement. The equivalent area of reinforcement used by the RC Slab Designer is that given by the expression attributed to Cope & Clark (1984):

$$A_n \approx \sum_{i=1}^N A_i \cos^4 \alpha_i$$

Where:

A_n = equivalent area of steel per unit width in the n-direction

A_i = area of steel per unit width in the i-direction (of total N layers of steel) at the face considered.

α_i = angle between the direction of ith layer of reinforcement and the direction perpendicular to the crack

The equivalent area calculated using this expression is described by Cope & Clark as being conservative for synclastic bending but unconservative for anticlastic bending. However the alternative equation offered by the same authors gives singularities where $\alpha = \pm 45^\circ$, and furthermore the equation above appears to give conservative answers compared to the method of Jofriet & McNeice. It is therefore adopted for all crack width calculations in the RC Slab Design facility within LUSAS.

The crack widths calculated are therefore notionally measured in the direction of the principal moment, based on an effective area of reinforcing steel which includes contributions from the two reinforcement directions in the tension zone of the slab as appropriate. That said, the reinforcement most nearly orthogonal to the crack (or widest crack, if cracking occurs in two directions) must be identified as the “controlling” direction. The results are subscripted with x or y to identify which bars are notionally controlling the cracking. Contours allow identifying which bars to modify in order to most efficiently control cracking in the slab.

Code of Practice rules for crack widths in beams generally include a reduction in consideration of the stiffening effect of tension carried by concrete that remains

bonded to the reinforcement in the tensile zone at small strains. However, where reinforcement does not lie perpendicular to cracks, as has been described to be the case in slabs, whether the “tension stiffening” reduction should be included is a matter of debate. Cope & Clarke suggest that tension stiffening should be ignored completely when principal moments act at $\alpha > 25^\circ$ to the reinforcement. The RC Slab Design facility in LUSAS offers crack check calculations with the tension stiffening component included, ignored (conservative) or interpolated. The “interpolated” option scales linearly from 0% tension stiffening at $\alpha = 25^\circ$, to 100% at $\alpha = 0^\circ$, and this is the default option.

In the case of crack-width calculations, it may be necessary to nominate a long-term loadcase on the [RC Slab Design : Crack Width Calculation Settings](#) page, in which case the active loadcase is used for additional short-term loading.

Bending and in-plane forces (Principal stresses)

Crack widths are determined from steel strains computed in an effective steel area in the direction of the principal stress. Since bar spacings are required in the crack widths calculations these results are collated according to the x and y` directions which represent the reinforcement directions. The orientation of the principal stress determines which bar is “controlling” but both directions contribute to the effective steel area. The effective steel area is determined in the direction of the cracking plane. The neutral axis is calculated taking into account the presence of both applied force and moment, in the direction of the principal stress.

The steel stress is therefore calculated by computing the forces in the steel and concrete resulting from the in-plane and bending effects as follows.

From force equilibrium:

$$F = F_c + F_s$$

Force in the steel

$$F_s = F \left(\frac{h/2 - x/3}{d - x/3} \right) - \frac{M}{d - x/3}$$

Stress in the steel

$$\sigma_s = \frac{F_s}{A_s}$$

Force in the concrete

$$F_c = F \left(\frac{d - h/2}{d - x/3} \right) + \frac{M}{d - x/3}$$

Stress in the concrete

$$\sigma_c = \frac{F_c}{bx/2}$$

Where

F = In-plane force in the principal stress direction.

F_c = Internal force in the concrete

F_s = Internal force in the steel

M = Moment in the principal stress direction.

h = Height of the section

x = Neutral axis accounting for in-plane and bending

d = Effective depth of tensile steel reinforcement

Notes

- The sign of the bending moment is changed to reflect the slab face being considered, the equations shown assume cracking at the bottom face where a negative moment causes tensile (positive) stress in the bottom face.
- Where the neutral axis is found to be outside the section and the section is therefore considered to be wholly in tension, the tensile force is distributed to the top and bottom bars, i.e. based on statics with the force assumed to act at the centre of the slab (h/2). The moment is then divided by the lever arm between the reinforcement layers.

Viewing RC Slab Design results

When the RC Slab Design settings have been made on the [Design Code Settings](#) page (for ULS Calculations) and additionally on the [Crack Width Calculation](#) settings page (for SLS calculations), values and results contours for a chosen results component can be displayed based on the active loadcase (or combination), using the most recently set results transformation, and are re-computed if a different loadcase is set active.



If the elements in a model are orientated such that their local axes vary from one another (and note for surfaces they may also vary from the surface orientation), or if an alternative coordinate system is required, the results may need to be transformed to a consistent direction. See [Results Transformation](#).

ULS Section Design

For Ultimate Limit State, and for a chosen slab face, the following RC slab design-related results components can be contoured:

Utilisation

- ❑ **Maximum utilisation [UtilMax]** The maximum of utilisation ratio value in x or y.
- ❑ **Utilisation in x [Util(Mx)] , Utilisation in y' [Util(My)]** Defined as the ratio of the design Wood-Armer moment from the active loadcase to the calculated flexural resistance e.g. $M_x(B)/M_{rx}(B)$. The flexural resistance is calculated from the reinforcement arrangement stated in the assigned **RC slab design attribute**.and is appropriate to the face and direction of the Wood-Armer moment. Values <1 indicate that the reinforcement is adequate.
- ❑ **Steel utilisation in x [Util(Nx)] , Steel utilisation in y' [Util(Ny)]** (in-plane forces only) Defined as the ratio of the steel stress to the design yield strength of reinforcing steel. See Results below for steel stress determination.
- ❑ **Concrete utilisation [Util(Fc)]** (in-plane forces only) Defined as the ratio of the concrete stress to the design compressive strength of concrete. See Results below for concrete stress determination.

Tension control limits

- ❑ **Tension control in x [Util(tcx)] , Tension control in y' [Util(tcy)]** This contour indicates whether the slab may be regarded as tension-controlled in respect of the current layer of reinforcement. This is expressed using a ratio (the specifics of which are detailed according to the Code of Practice) calculated from the reinforcement arrangement stated in the assigned **RC slab design attribute**. Values <1 indicate that the slab is tension-controlled and thus the slab may be regarded as ductile. Values >1 indicate that reinforcement calculations may be unconservative; use of compression steel in slabs is not recommended and so slab depth may need to be increased.

Results

- ❑ **Steel stress in x [Ssx] , Steel stress in y' [Ssy]** (in-plane forces only) Steel stress is determined directly from the Clark-Nielsen force and the steel area in a given direction. The stress in the steel is checked against the material yield limits provided in the Design Code Settings dialog with allowance for code defined factors.

- ❑ **Concrete stress [Sc]** (in-plane forces only) The concrete stress is determined from the Clark-Nielsen force (F_c) and an assumed depth of concrete taken as twice the distance from the outer face to the centre of reinforcement on that face. The concrete stress is checked against material limits provided in the Design Code Settings dialog with allowance for partial factors.

Design

- ❑ **Area of steel in x [Asx], Area of steel in y' [Asy]** This contour indicates the minimum area of reinforcing steel per unit width required to obtain a flexural resistance equal to the design Wood-Armer moment or Clark-Nielsen force from the active loadcase. The minimum area for both faces and both directions must be provided for a safe design. The effective depth and lever arm used in the calculations is, in each case, based on the bar size and other parameters specified.
- ❑ **Bar diameter in x [Diax], Bar diameter in y' [Diay]** Assuming the bar spacing stated in the assigned **RC slab design attribute** is to be used, this contour indicates the minimum bar size required to obtain the steel area described above.

SLS Reinforcement Design Contours

For Serviceability Limit State, and for a chosen slab face, the following RC slab design-related results components can be contoured:

Crack widths

- ❑ **Controlled in X [CWx]** Whilst the crack widths are determined in the direction of principal moments/stresses and do not necessarily correspond to a particular reinforcement direction, the crack is considered to be controlled by the reinforcement to which it is most nearly orthogonal, or, when the principal direction lies at an angle no more aligned to either reinforcement direction, by the outermost reinforcement layer. This contour reports the maximum crack widths controlled by the x-direction reinforcement, enabling the user to identify if the maximum cracks observed are best controlled by modifying x-direction steel.
- ❑ **Controlled in Y [Cwy]** This contour reports the maximum crack widths controlled by the y-direction reinforcement, enabling the user to identify if the maximum cracks observed are best controlled by modifying y-direction steel.
- ❑ **Maximum [CWM_{max}]** This contour indicates the maximum crack width calculated for the face of the slab in question. The crack width reported is the width perpendicular to the crack, which may not be orthogonal to the reinforcement provided.
- ❑ **Utilisation [Util(CWM_{max})]** This contour indicates how the maximum calculated crack width compares to the allowable crack width specified on the **crack width settings** page.

RC slab design results components

Results component names related to reinforced concrete slab design are shown in the table below. These are available for selection from the results component drop-down list of the main Values or Contour results property dialogs. The notation (T) and (B) is appended to the results components to denote top and bottom faces of the slab respectively.

ULS - Bending only

LUSAS results component	Description
UtilMax(T)	Maximum of Util(Mx(T)) and Util(My(T))
Util(Mx(T))	Utilisation: applied Wood-Armer moment in the x-direction (Top face) divided by corresponding bending resistance
Util(My(T))	Utilisation: applied Wood-Armer moment in the y'-direction (Top face) divided by corresponding bending resistance
Util(tcx(T))	Utilisation of tension control factor in x (Top face)
Util(tcy(T))	Utilisation of tension control factor in y' (Top face)
Asx(T)	Area of steel required in x (Top face)
Asy(T)	Area of steel required in y' (Top face)
DiAx(T)	Diameter of bar required in x (Top face)
DiAy(T)	Diameter of bar required in y' (Top face)

Note that slab design results are shown for x and y' axes, where y' is measured from the x axis according to the skew angle of the reinforcement specified in the RC Slab attribute.

ULS - Bending and in-plane effects

LUSAS results component	Description
UtilMax(T)	Maximum of Util(Nx(T)), Util(Ny(T)) and Util(Fc(T))
Util(Nx(T))	Utilisation: applied Clark-Nielsen force in the x-direction (Top face) divided by corresponding factored tension capacity of reinforcement in the x-direction.
Util(Ny(T))	Utilisation: applied Clark-Nielsen force in the y'-direction (Top face) divided by corresponding factored tension capacity of reinforcement in the y'-direction.
Util(Fc(T))	Utilisation: concrete force per unit width (Top face) from Clark Nielsen theory divided by factored concrete strength
Ssx(T)	Stress in the reinforcing steel in the x direction (Top face)
Ssy(T)	Stress in the reinforcing steel in the y' direction (Top face)
Sc(T)	Stress in the concrete (Top face)

Asx(T)	Area of steel required in x (Top face)
Asy(T)	Area of steel required in y` (Top face)
Diax(T)	Diameter of bar required in x (Top face)
Diay(T)	Diameter of bar required in y` (Top face)

SLS - Bending and in-plane effects

LUSAS results component	Description
CWx(T)	Crack widths controlled by bars in the x direction (Top face)
CWy(T)	Crack widths controlled by bars in the y` direction (Top face)
CWMax(T)	Maximum crack width (Top face)
Util(CWMax(T))	Utilisation: calculated maximum crack width (Top face) divided by specified allowable crack width)

Note: (B) is appended in place of (T) in RC Slab design results components to signify Bottom face when appropriate

General notes relating to RC slab design results

The RC Slab design facility provides the means to carry out basic design checks on various reinforced concrete structures. It should be noted that:

- The ULS calculation for bending with in-plane forces is based on Clark-Nielsen and this can be shown to be inaccurate if in-plane forces are negligible. In addition it provides no guarantee that the section is "tension controlled" and no check is carried out since forces at the top and bottom faces are calculated separately.
- SLS deflections and curvatures are not calculated.
- RC Slab design calculations are not included in reports, but slab design-specific results components can be included.

Reinforced Concrete Frame Design

Overview

Design checks due to bending with or without axial force can be carried out at the Ultimate Limit State (ULS) and Serviceability limit states (SLS) for a specified RC design code.

Design code checking of regular and arbitrary shaped reinforced concrete decks/beams (and piers/columns) with or without voids is performed as a results processing operation following the solving of a model, and requires the inclusion of reinforcement arrangements within the geometric line attribute as well as the assignment of design code specific RC frame design attributes to lines in the model that represent concrete members. The use of reinforced concrete materials and reinforcement arrangements is for design check calculations only. The analysis is unaffected and carried out using the gross concrete section.

RC frame design is available for use with selected Bridge and Civil software products only, and only for licences that support this facility.

Meshing and analysis considerations

Lines representing reinforced concrete frame members must be assigned a 3-dimensional beam line mesh (thick beam, thick cross section beam, thick beam with torsional warping, thick cross section beam with torsional warping, thin beam, semiloof beam, semiloof cross section beam).

Section capacity checks for selected members can be carried out at nodes, internal points or at inspection locations. Because of this any number of elements could be assigned to a line, but using an excessive element assignment will increase the time

required to carry out the design checks. It is recommended that lines should be assigned at least 2 elements and preferably a minimum of 4 elements.

Carrying out a reinforced concrete frame design check

For a model that is otherwise complete in all respects, the following steps are required to carry out a reinforced concrete frame design check of members that are modelled with 3D line beam elements.

1. **Specify the section reinforcement** to be provided in concrete sections, and **line reinforcement**, which states the lengths over which the section reinforcement arrangements are effective. Note that no allowance is made for laps or anchorage lengths.
2. **Define/edit geometric line attributes** to reference a desired line reinforcement utility and assign the geometric line attribute to lines representing concrete members in the model.
3. **Specify the design code** to be used for the check by selecting the **Design> RC Frame Design** menu item.
4. **Define reinforced concrete material** and assign to all lines representing reinforced concrete members.
5. **Define RC frame design attributes**. These provide design related information and should be assigned to all lines representing reinforced concrete members.
6. **Specify the results required** by selecting the **Design> RC Frame Design Results** menu item.
7. **View the results** either on the model, in tabular format, as an interaction surface diagram, or by using the print results wizard.

Note that because section and line reinforcement details, and RC frame design attributes have no impact on a structural analysis they can be defined and assigned either before or after a model has been initially solved.

RC frame design attributes

Reinforced Concrete frame design attributes are used to specify additional information about the design checks (information that is specific to the Code of Practice and to the member in question). Attributes are defined using the **Attributes> Design> RC Frame Design...** menu item, which is available in Bridge and Civil software products only, and for licences that support this facility.

Typical information defined in a RC frame design attribute includes:

- Beam and column minimum reinforcement ratios
- Calculation methodology

- Parameters for stress limitation and crack control
- Creep parameters

Once defined, a Design attribute entry is created in the Attributes  Treeview ready for assignment to selected lines in a model.

Design codes supported



The following design codes are currently supported:

- EN1992-1-1 :2004** - EN 1992-1-1:2004 +A1 Eurocode 2: Design of concrete structures Part 1-1: General rules and rules for buildings. The Eurocode National Annexes currently supported are:
 - Eurocode Recommended Values
 - Austria
 - Belgium
 - Bulgaria
 - Cyprus
 - Czech Republic
 - Denmark
 - Finland
 - France
 - Germany
 - Greenland
 - Ireland
 - Italy
 - Netherlands
 - Poland
 - Romania
 - Singapore
 - Slovakia
 - Spain
 - United Kingdom
- EN1992-2: 2005** - EN1992-2: 2005 Eurocode 2: Design of concrete structures Part 2: Concrete bridges - Design and detailing rules. The Eurocode National Annexes currently supported are:
 - Eurocode Recommended Values
 - Bulgaria
 - Cyprus
 - Denmark
 - Italy
 - Poland
 - Romania
 - Spain

- Finland
- Sweden
- Ireland
- United Kingdom

Note that the same RC frame design attribute is used for both EN 1992-1-1:2004 and EN1992-2: 2005 design codes.

Specify RC frame design results required

The **Design > RC Frame Design Results** menu item allows engineers to bring together loadcases / combinations appropriate to the various ULS and SLS checks and identify members for which calculations are required, along with other calculation options. One or more RC Frame Results objects must be created in order to view graphical or tabular results from design check calculations. The settings available on the dialog are described here. On completion an RC Frame Design loadcase / results container entry  is created in the Analyses  Treeview.

Multiple RC Frame Design results loadcases can be defined enabling design calculations to be carried out for different extents (lines) within a model, at different locations along each line, and for chosen load groups, and design checks. For example, setting up an RC Frame Design results entry for all beams in a model and a separate one for all columns will limit the number of design checks to be carried out each time a change is made to one or the other.

Extent

Choose the extent from:

- All members** - all lines in the model.
- Visible members** - only those lines that are visible in the view window.
- From group** - only those lines present in a selected group.
- Geometric attribute** - only those lines assigned a particular geometric line attribute.
- Line(s) ID** - If lines are selected prior to opening the RC Frame Design Results dialog, those line numbers will be listed here. Otherwise, type line numbers or make a selection in the view window and press the **Update** button to include line numbers of the selection in the listing.

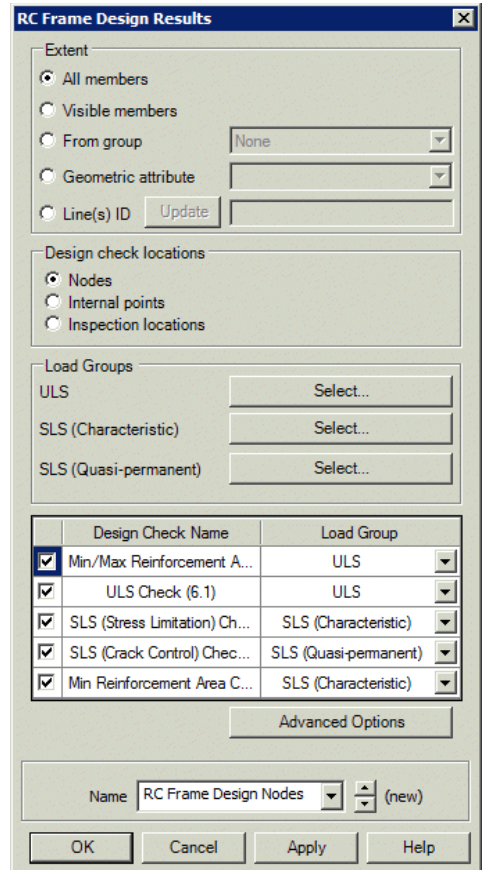

Design check locations

A list of design checks applicable to a chosen design code are listed, and can be individually selected by check-box to be included in a summary table for the following locations:

- Nodes** - the nodes at the ends and within each beam element that is assigned to a member.
- Internal points** - the internal (calculation) points for each element. Each element is discretised into ten divisions for calculation and results viewing purposes. This produces nine equally-spaced points along each element with two end points coinciding with the nodal locations of the element.
- Inspection locations** - a defined position of interest on a line for results extraction / viewing purposes. When choosing this option at least one **inspection location** must be assigned to each line in the model that represents a reinforced concrete member. Note that inspection locations used in isolation may not pick-up extreme values.

Viewing of RC frame design results for nodes will enable an initial design check to be carried out. The time taken to carry out a design check is directly related to the number of nodes, internal points or inspection locations used.

Load Groups

Loadcases applicable to a particular load group need to be specified.

- ULS** - Ultimate Limit State
- SLS - Characteristic** - Serviceability Limit State - Characteristic
- SLS - Quasi-permanent** - Serviceability Limit State - Quasi-permanent

By default, load groups appropriate to the check will be set 'automatically'.

Design check name



A Load Group needs to be specified for each of the following design checks:

- Min / Max Reinforcement Area**
- ULS Check**
- SLS (Stress Limitation) Check**
- SLS (Crack Control) Check**
- Min Reinforcement Area Check (7.3.2)**

Advanced options

Primary components (and coincident effects) that will be used to define load combinations for **smart combinations** and **envelopes** can be specified, along with combinations of extreme values.

Name

Specify the name of the RC Frame Design loadcase / results container entry  to be created in the Analyses  Treeview.

Viewing RC frame design results

RC frame design results can only be calculated if lines representing concrete members have been included in an RC Frame Design loadcase / results container and have also been assigned all required attributes. These are:

- A 3D beam mesh attribute
- A geometric line attribute referencing a reinforcement line definition
- A reinforced concrete material attribute
- An RC Frame Design code specific design attribute



When all appropriate attributes are defined, utilisation values and more detailed RC Frame Design results can be viewed:

- On the model
- By tabulating RC frame design results
- By using the print results wizard

Viewing utilisation results on the model

RC frame design results can be visualised on the model as utilisation ratios on a contour, values or diagrams layer for a selected design code and active RC Frame Design loadcase / results container. Results components for individual design checks can be chosen for viewing. See [Visualising the Results](#) for details.

To view RC frame design results:

1. In the Analyses  Treeview set the RC frame design loadcase entry  active.
2. Add either a contours, diagrams or values layer to the Layers  Treeview
3. On the contours, diagrams or values properties dialog choose the RC frame design code entity and a suitable results component. Utilisation ratios for individual design checks or a design code summary showing values of Util(max) can be viewed.

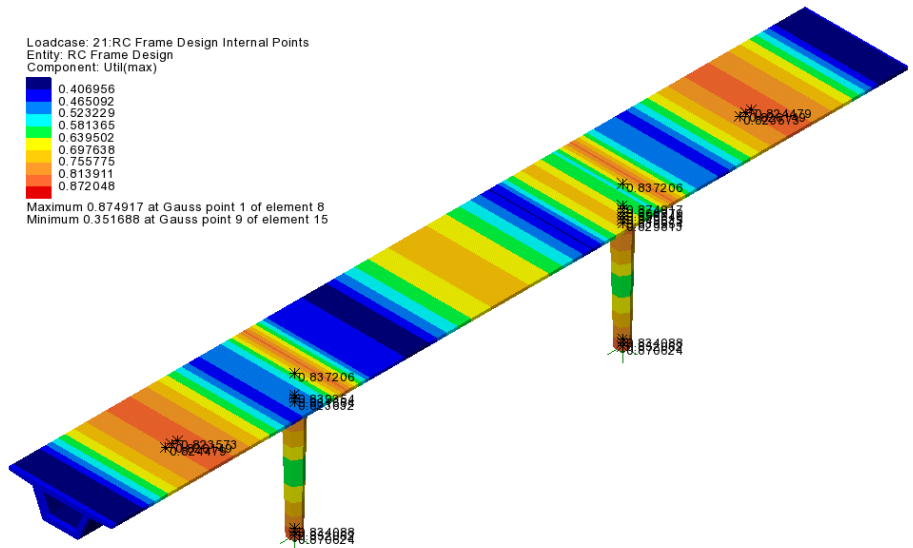

Notes:

- For a design check location of 'Node', a colour-filled spot contour plot is produced showing the value of the chosen component at each node.

- For a design check location of 'Internal Point', the values obtained at each internal point are interpolated to create line contours. These can also be drawn on fleshed sections.
- When making changes to geometric attributes a model must be re-solved to see the result of that change. When making changes to reinforcement quantities there is no need to re-solve the model; the RC Frame Design calculations will be automatically re-run according to the changes made.
- RC frame design checks cannot be carried out if geometric properties used in different analyses that are set-up within a single model are in conflict.

Results components

The following tables show the names of LUSAS derived results components and how they relate to currently supported clauses from stated design codes:

EN 1992-1-1 and EN1992-2

<u>LUSAS results component</u>	<u>EN1992-1-1 and EN1992-2</u>
Util(Amin, Amax)	Utilisation due to min and max reinforcement area
Util(ULS)	Utilisation due to ULS check
Util(SLS,S)	Utilisation due to stress limitation
Util(SLS,C)	Utilisation due to crack width
Util(Amin)	Utilisation due to the minimum reinforcement area (7.3.2)
Util(max)	Maximum utilisation

Utilisation ratios

The utilisation ratio along the length of each visible member in the model is shown for the selected result type for the active RC Frame Design loadcase. With regards to utilisations the following should be noted:



- Where a check is not required the utilisation is assumed to be zero (drawn as a blue contour by default).
- Where a check cannot be carried out because a problem is identified but the solution is outside the scope of the current design check, no contours are plotted.

Notes

- Design results are considered to be "Derived Components" in LUSAS. This means they may be computed for smart combinations only when a valid primary component is selected. Valid primary components are any of the

corresponding thick beam stress resultants F_x , F_y , F_z , M_x , M_y , M_z . For more on derived components see [Raw and Derived Components](#).

Tabulating RC frame design results

Utilisation results and more detailed information can be obtained by right-clicking on the RC Frame Design loadcase / results container  in the Analyses  Treeview and selecting the **Show Results** menu item. A results table is created showing a summary page and separate tabbed pages for each of the design checks requested in the RC Frame Design Check dialog.

For any page, when a row in the table is selected, more detailed results can be obtained by double-clicking on the row, or by pressing the **Detailed Results for Selected Row** button. These tables of results and detailed results can be added to a model report.



For a ULS check a resistance interaction surface may also be created by pressing the **Resistance Interaction Surface (All the internal forces included)** button.

For more details see "Tabulating RC Frame Design results for EN1992-1-1 and EN1992-2" on page 545.

Viewing utilisation results using the print results wizard

The utilisation results for the same results components that can be viewed on an RC frame design model can be tabulated for viewing and adding to a report using the [print results wizard](#).

Adding RC frame design results to a model report

RC frame design results can be added to a [model report](#) either by using the **Add to report**  button on the respective results dialog, or by using the **Add to report** context menu item for the named RC Frame design loadcase loadcase entry  in the Analyses  Treeview. In doing so, each time the model report is generated the design summary data will be updated to match the current state of the model.

Changing concrete member properties

Changes can be made to [RC frame design attributes](#) and [section \(and line\) reinforcement details](#) without requiring a model to be re-solved. However, for each change made, design checks are automatically re-computed to show the effects of making the change. If this is not required, turn-off the display of any results-based layers (contours, values, diagrams or deformed mesh) in the Layers Treeview prior to making any changes.

Worked example

- See Help> Help Topics> Worked Examples > For Design Option > 'RC Frame Design'.

Section reinforcement

Section reinforcement defines the bar arrangements to be provided in a member's cross-section. Section reinforcement is a utility object stored as an entry in the Utilities  Treeview and cannot be assigned to lines in the model directly. Section reinforcement utilities are referenced by **line reinforcement** utilities (that define the length over which each section reinforcement utility acts along a line representing a reinforced concrete member.)

The section reinforcement dialog can be accessed from a reinforcement line dialog (by selecting the 'New' option in the reinforcement section droplist) or by using the **Utilities > Reinforcement > Section** menu item. Section reinforcement can be defined for any standard or arbitrary shape, with or without voids. Tapering members are also supported.

Section reinforcement is available for use with selected Bridge and Civil software products only, and for licences that support **RC frame design**. A model **analysis category** of 3D must also be in use.

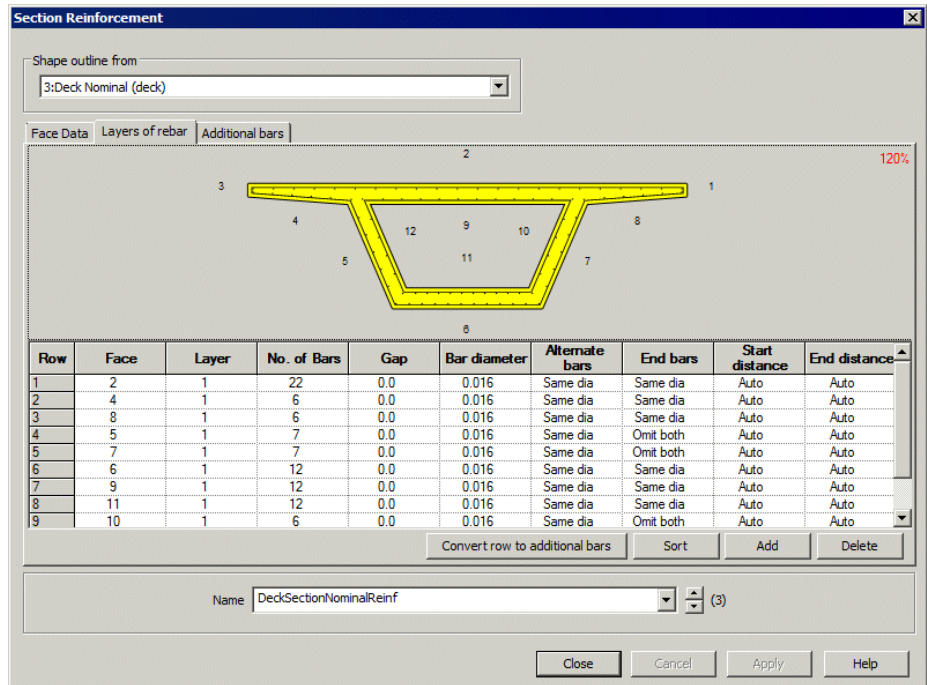

Defining section reinforcement

The section reinforcement dialog comprises three tabbed pages that are used to define the reinforcement arrangements for a concrete member's cross-section. This requires stating the concrete faces to be reinforced, the cover and allowance for links, and the layers and positions of reinforcing bars.

- ❑ **Shape outline from** A predefined geometric line attribute can be selected to assist in the definition of section reinforcement. The coordinates of the lines defining the section shape of the geometric line attribute are used to automatically determine and number the faces of the beam cross-section. Faces are always numbered anti-clockwise on the visualised section. Layers of reinforcement are defined with reference to each numbered face. Additional bars are defined with respect to the beam axis.

Notes

- In specifying a shape outline, the chosen **geometric line attribute** is not explicitly connected to the reinforcement section, it merely provides a visual reference for the face numbering in use and reinforcement arrangement being defined for that section type. This means that a section reinforcement arrangement for one section shape may also be applied to other geometric attributes of a similar shape. For example, section reinforcement could be

defined for a beam that is 400mm x 400mm and also be used to reinforce other sections of a similar shape, such as 400mm x 600mm, or 300mm x 600mm, by including the appropriate line reinforcement utility in unique geometric line attributes. This also makes the system effective / efficient for tapering sections.

- Deleting a geometric line attribute from the Attributes Treeview that is referenced by the section reinforcement utility will not make the section utility invalid. However, no visualisation of the section type on the dialog is possible until a geometric line attribute is selected again from the 'Shape outline from' droplist.
- In all cases covers, distances, bar diameters, and spacings are to be stated in model units.

Visualising section reinforcement

A section formed from the shape outline selected and the reinforcement as it is defined is shown on the dialog. Section reinforcement can be inspected by zooming and panning the visualised section. A changing cursor image indicates whether the facility is enabled or not. If necessary, click in the panel to activate this facility. Use the mouse wheel to zoom in and out. Click and hold-down the left mouse button, or click and hold-down the mouse wheel to pan.

Reinforcement terms used

The following image explains the main terms used on the section reinforcement dialog:

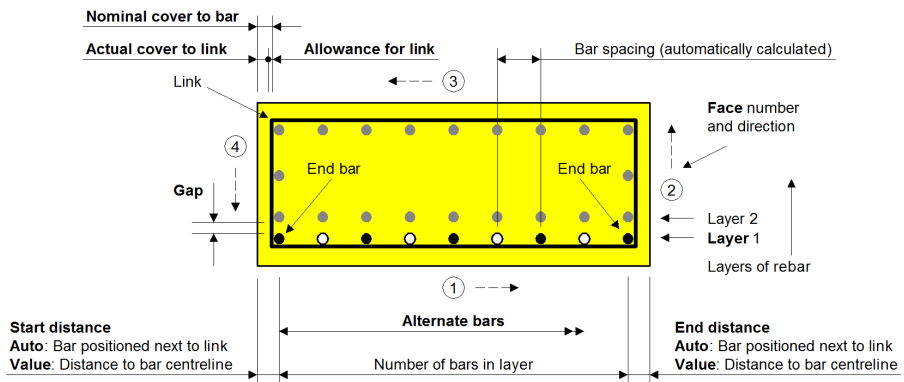

Reinforcement terms used

Face data

Section Reinforcement

Shape outline from
4:LGeo4 (RSS D=0.5 B=0.4)

Face Data | Layers of rebar | Additional bars

100%

Row	Face	Actual cover to link	Nominal cover to bars	Allowance for link
1	All	0.03	Actual	0.01

Add Delete

Name: RC Beam Example 1 (new)

OK Cancel Apply Help

Defining face, cover and link data for a member

For all, or individual faces of the section, the actual and nominal covers, and allowance for links must be stated.

- Face** When a shape outline has been specified, the default entry for Face is 'All', meaning that all faces will be assigned the settings made on the row. However, additional rows may be added and by entering a face number different covers on different faces can be stated. Cover and link allowance settings on those referenced faces will override the settings made for 'All' on those faces.
- Actual cover to link** Define the distance from the face to the outside fibre of the link.
- Nominal cover to bars** If 'Actual' is entered, the nominal cover will be calculated automatically from 'Actual cover to link' + 'Allowance for link'. Alternatively, a user-defined value may be entered. The value entered is used in
- Allowance for link** Define the bar diameter of the link for positioning of longitudinal reinforcement. Shear and torsion checks are not included.

The leg(s) of a link in a selected row is drawn in blue in the section visualisation on the dialog, otherwise all legs of a links are drawn in black. Layers of reinforcement bars are not drawn in this page.

Table related buttons

- Add** and **Delete** buttons add or remove rows from the table.

Layers of rebar

	Face	Layer	No. of Bars	Gap	Bar diameter	Alternate bars	End bars	Start distance	End distance
1	1	1	4	0.0	0.032	Same dia	Same dia	Auto	Auto
2	2	1	4	0.0	0.016	Same dia	Omit both	Auto	Auto
3	3	1	4	0.0	0.025	Same dia	Same dia	Auto	Auto
4	4	1	4	0.0	0.016	Same dia	Omit both	Auto	Auto

Defining main section reinforcement for four faces of a member

Overview

Layers of reinforcement are defined by entering a row of data for a numbered face. Faces forming the perimeter of a solid section are numbered anti-clockwise. Faces forming the perimeter of voids within a section are numbered clockwise. References to 'Start' and 'End' with regard to bar diameters and distances stated in the grid relate to the start and end of a face. For example face 2 starts at the end of face 1, and ends at the start of face 3. Note that bar diameters and distances must be defined in model units.

Bars are spaced equally in a layer with respect to a specified face. Where end bars in layers in different faces clash (as in the preceding example), the end bars from selected faces (the side faces in the preceding example) may be omitted by making the appropriate selection on the dialog.

Multiple rows of data in the table can be used to position bars in a specified face, enabling the definition of more dense or sparse reinforcement within a layer for a face, as shown on the following image.

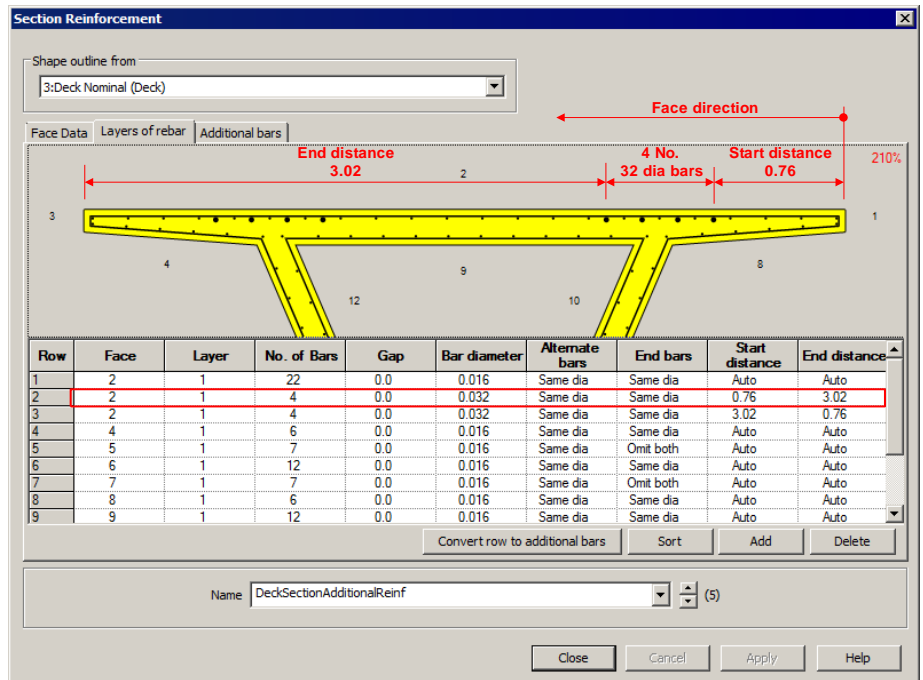

Defining additional reinforcement in a specified region of a face for a box section

Layers of rebar terms

See [Reinforcement terms used](#) for further explanation of the following options.

- Face** The number of the face for which the layer reinforcement is being defined.
- Layer** The layer number for the reinforcement. Layer 1 is the layer nearest the face. Multiple layers can be defined for a face with layers separated by a Gap (see below).
- No. of Bars** The number of bars to be included in this layer / row.
- Gap** The distance between the outermost fibre of this layer of rebar and the innermost fibre of the previous layer on the same face
- Bar diameter** The diameter of bars in this layer / row of data entered in model units.
- Alternate bars** The diameter of every alternate bar in this layer / row. If **Same dia** is selected all bars are the size defined by 'Bar diameter'. A user-defined bar diameter may be input instead.
- End bars** Defines the diameter of the outermost (end) bars in this layer / row. If **Same dia** is selected the end bars are the size defined by 'Bar diameter'. A user-defined bar diameter may be input instead. Defining bars in a layer for one

face typically results in the corner bars at each end of a set or run of bars coinciding with the corner bars in a layer in another face. In such cases select **Omit both** from the droplist to remove the unwanted bars at both ends of one layer / row (as shown in for Faces 2 and 4 in the preceding image), or **Omit start** to remove one bar at the start of a run, or **Omit end** to remove one bar at the end of run of bars for the layer / row, as appropriate. The previously calculated and visualised spacing of the other bars in the face being edited will not change.

- Start distance** Defines the location of the outermost (starting) bar in this layer / row. If 'Auto' is selected the starting bar of the layer / row will be placed automatically to sit tight to the adjacent leg(s) of the link. If a value is entered by over-typing in this cell, for orthogonal faces the centreline of the bar will be placed at the stated distance from the adjacent face. In non-orthogonal faces the centreline of the bar will be placed at the stated distance from the intersection of the two adjacent faces.
- End distance** Defines the location of the outermost (ending) bar in a layer. If 'Auto' is selected the ending bar of the layer will be placed automatically to sit tight to the adjacent leg(s) of the link. If a value is entered by over-typing in this cell, for orthogonal faces the centreline of the bar will be placed at the stated distance from the adjacent face. In non-orthogonal faces the centreline of the bar will be placed at the stated distance from the intersection of the two adjacent faces.

The leg of a link in a selected row is drawn in blue in the section visualisation on the dialog, otherwise all legs of a links are drawn in black. Any additional bars are drawn in grey. Bars that clash with other bars, or that are positioned outside the section are drawn in red.

Note that whilst bars may be omitted at one end, the remaining bar at the other end cannot currently be specified with a different diameter and will inherit the bar diameter from the Bar diameter column.

Table related buttons

- Convert row to additional bars** Deletes the currently selected row in the grid, inserting new rows in the grid of the 'Additional bars' page for each bar containing the appropriate data.
- Sort** Sorts the grid rows by face and then layer
- Add** and **Delete** buttons add or remove rows from the table.

Additional bars

Face Data
Layers of rebar
Additional bars

100%

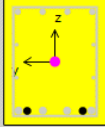

Bar ref	y	z	Diameter	Nominal cover to bars	Spacing
1	0.11	-0.195	0.032	Actual	Auto
2	-0.11	-0.195	0.032	Actual	Auto

Add
Delete

Defining additional bars in a face/layer

Additional bars may be added to a reinforcement arrangement. They are defined by a coordinate defining the centre of the bar with respect to the beam axis. Unlike bars defined on the 'Layers of rebar' tab, additional bars are not defined with respect to a specified face.

The local axes of the section are shown at its centroid. The magenta filled circle represents the location of the nodal line about which the section will be positioned when the section is assigned to a line on the model.

- y** Defines the y location of the bar relative to the axis shown in the visualisation of the section shape.
- z** Defines the z location of the bar relative to the axis shown in the visualisation of the section shape.
- Diameter** The diameter of the additional bar.
- Nominal cover to bars** If 'Actual' is entered, the nominal cover will be calculated automatically from 'Actual cover to link' + 'Allowance for link' (as stated on the 'Face Data' page.) Alternatively, a user-defined value may be entered.
- Spacing** Selecting 'Auto' will cause bar spacings for crack width calculation checks to be based on the nearest bar. A user-defined value may optionally be entered, and if done, is used for the crack width calculation for that bar location only.

For a selected row, a bar is drawn in blue in the section visualisation on the dialog, otherwise all other bars are drawn in black. Bars that clash with other bars, or that are

placed outside the section are drawn in red. Other reinforcement (defined on Faces data and Layers of rebar tabs) is drawn in grey.

Table related buttons

- ❑ **Add** and **Delete** buttons add or remove rows from the table.

Bar positioning, spacing and crack width calculation

By default the positioning of end bars in a layer assumes a zero internal radius for a link, with the bars being fitted tight to the link. For many purposes, the effect of a difference in actual to modelled end bar position will be negligible in comparison to other assumptions inherent in the analysis and design process. However, manual positioning of end bars can be done by omitting the end bars on the 'Layers of rebar' tab, and using the 'Additional bars' tab to manually place end bars in a desired location.

Bar spacing used for determination of crack widths is calculated by considering each bar in the section. The presence of any bundled bars is identified initially, with an appropriate equivalent diameter and location based upon the centre of area of the bundle being calculated. Then, for each bar in the section, the spacing used for crack width calculation is arrived at by considering the distance to the closest bar measured parallel to the concrete face, discounting bars in a 45 degree cone 'behind' the bar in question. Two nearest faces are considered in order to evaluate values for corner bars reasonably. If more control over the spacing assumed for the determination of crack widths is required, the 'Additional bars' tab allows user input of the value, bar by bar. Individual layers of rebar may be converted to 'Additional bars'.

Copying reinforcement details between models

Section reinforcement details can be transferred between models. See [Transferring Data Between Models](#).

Line reinforcement

Line reinforcement is referenced by [geometric line beam](#) attributes (that define the concrete section size/shape and properties for a member). Line reinforcement is used to specify how individual [section reinforcement](#) arrangements apply over a length of a line or lines representing a concrete member. Line reinforcement is a utility object stored as an entry in the Utilities  Treeview and cannot be assigned to lines in the model directly.

The line reinforcement dialog can be accessed from a geometric line attribute dialog (by selecting the 'New' option in the reinforcement panel), or by using the **Utilities > Reinforcement > Line** menu item.

Line reinforcement is available for use with selected Bridge and Civil software products only, and for licences that support [RC frame design](#). A model [analysis category](#) of 3D must also be in use.

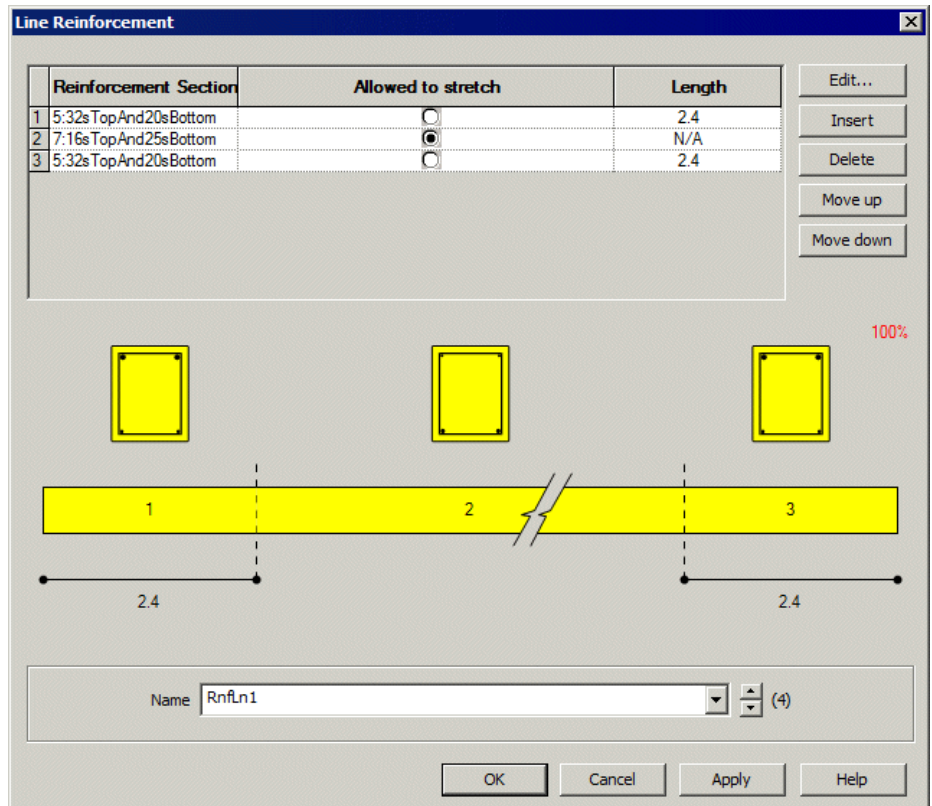

Defining line reinforcement

In the line reinforcement table the reinforcement sections and the length over which each reinforcement section applies are stated.

- ❑ **Reinforcement section** Clicking on the launch dialog button  in this cell lists any previously defined **section reinforcement** utilities for selection. A **New** button allows new **section reinforcement** arrangements to be defined.
- ❑ **Allowed to stretch/ Length** When more than one reinforcement section is included, the length over which each section applies must be stated in the **Length** column. The remaining section will be defined as **Allowed to stretch** to signify that this reinforcement section arrangement will apply over the remaining length of line to which it is assigned.

As each row is added or edited a schematic diagram beneath the table will update to show the revised arrangement. Any number of section reinforcement arrangements may be included to form a line reinforcement utility.

Table related buttons

- ❑ **Edit, Insert and Delete** buttons provide the means to edit reinforcement sections, create new rows above a selected row, and to delete rows from the table.
- ❑ **Move up and Move down** buttons allows re-ordering of a selected row within the table.

Usage

Once defined, line reinforcement utilities are added to the Utilities  Treeview. They cannot be directly assigned to lines in a model. They are assigned to the model as a function of assigning the **geometric line beam** attribute in which they are referenced. When assigning to single or multiple selected lines the following options are provided:

- ❑ **Consider selection as a single assignment** The line reinforcement details will start and end at the start and end of the line or set of lines selected. For a set of lines the line direction of each line must be the same.
- ❑ **Consider each selected item individually** The line reinforcement details will start at the start of each selected line, and end at the end of each selected line. as dictated by the line directions.

Examples of line reinforcement assignments

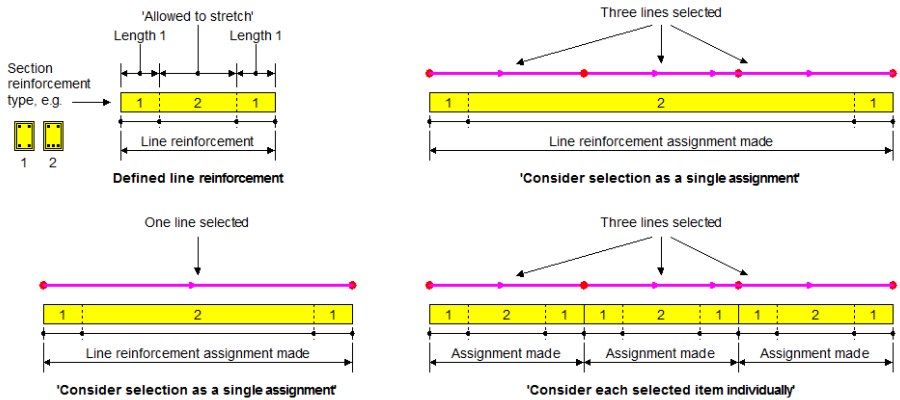

Examples of assigning geometric line attributes that reference line reinforcement

Note that it also possible to select separate sets of continuous lines (for example three sets of lines with three lines in each set) and assign a line reinforcement attribute to all at the same time using the 'Consider as a single assignment' option.

Example of 'Consider selection as a single assignment'

Three section reinforcement utilities are defined, assembled and assigned to a set of lines representing a bridge deck.

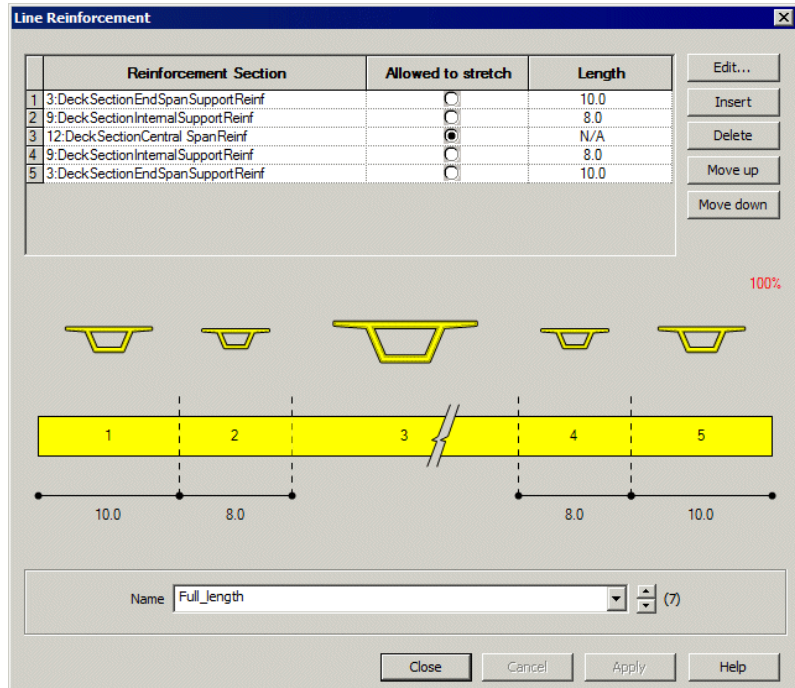

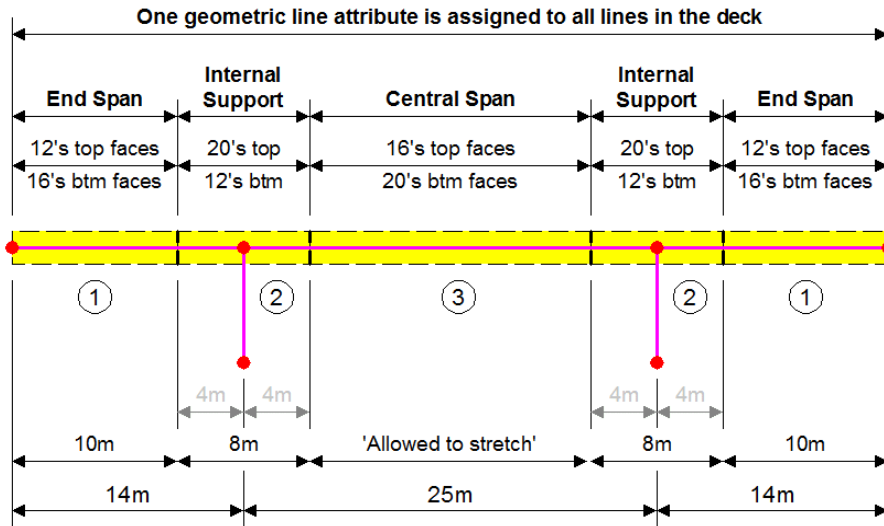

Copying between models

Line reinforcement details can be transferred between models. See [Transferring Data Between Models](#).

Concrete (Reinforced) Material Model

Reinforced concrete material for use with the **RC frame design** facility is defined by selecting the **Attributes > Material > Concrete (Reinforced)** menu item. This material references linear elastic concrete and steel materials provided in the **Material Library**. The entries are filtered to show those that are valid according to the Code of Practice selected.

To carry out reinforced concrete frame design checks, a concrete material and a reinforcement material need to be assigned to the lines representing reinforced concrete members in the model. This cannot be done by defining and assigning separate concrete and steel material attributes (since only one material can be assigned to a line feature within Modeller) so the concrete (reinforced) material model, which provides a compound material attribute, must be defined and assigned instead.

When created, three material entries appear in the Attributes  Treeview, one for each concrete and steel isotropic material defined, and one compound material entry that references them both. To carry out reinforced concrete frame design checks only the compound material attribute should be assigned to lines in the model representing reinforced concrete members.

RC Frame Design - Code Selection

To enable a RC frame design check to be carried out a design code must be selected by using the **Design> RC Frame Design** menu item. This is available for use with selected Bridge and Civil software products only, and only for licences that support this facility. See [RC Frame Design - Code Checking](#) for the procedure involved.

Reinforced concrete section capacity checks for the following design codes can be obtained by creating and assigning RC frame design attributes to those lines in a model that represent concrete members.

Codes supported

- EN1992-1-1: 2004** - EN 1992-1-1:2004 +A1 Eurocode 2: Design of concrete structures Part 1-1: General rules and rules for buildings. This selection permits the selection of a National Annex and optional changing of code parameters.
 - Eurocode National Annexes currently supported are: “Eurocode Recommended Values”, Austria, Belgium, Bulgaria, Cyprus, Czech Republic, Denmark, Finland, France, Germany, Greenland, Ireland, Italy, Netherlands, Poland, Romania, Singapore, Slovakia, Spain, United Kingdom.
 - For each Eurocode National Annex there are a number of Nationally Determined Parameters (NDPs) listed.
 - Recommended Values (RVs) are usually given in the main Eurocode document.
 - Numeric Values listed may be edited but note that such an option may not be given in the respective National Annex.
 - Only those NDP values used in the design calculations are shown.

- EN1992-2: 2005** - EN 1992-2:2005 Eurocode 2: Design of concrete structures Part 2: Concrete bridges — Design and detailing rules. This selection permits the selection of a National Annex and optional changing of code parameters.
 - Eurocode National Annexes currently supported are: “Eurocode Recommended Values”, Bulgaria, Cyprus, Denmark, Finland, Ireland, Italy, Poland, Romania, Spain, Sweden, United Kingdom.
 - For each Eurocode National Annex there are a number of Nationally Determined Parameters (NDPs) listed.
 - Recommended Values (RVs) are usually given in the main Eurocode document.
 - Numeric Values listed may be edited but note that such an option may not be given in the respective National Annex.

- Only those NDP values used in the design calculations are shown.

Code parameters

Default values supplied for each supported code can be adjusted if required. They are:

Partial factors for materials

Concrete (Gamma_c)

- Ultimate limit states (ULS)
- Serviceability limit state (SLS)

Reinforcing steel (Gamma_s)

- Ultimate limit states (ULS)
- Serviceability limit state (SLS)

Coefficient for long term effects for concrete

- Alpha_cc
- Alpha_ct

RC Frame Design Attributes

Reinforced Concrete frame design attributes are used to specify additional Code of Practice specific information about model line features that represent concrete members in order to enable **RC frame design** checks to be carried out. Note that this additional information is not required for an initial structural analysis to be carried out.

RC frame design attributes can be defined using the **Attributes> Design> RC Frame Design...** menu item that is available for use with selected Bridge and Civil software products for licences that support this facility, and only if a model **analysis category** of 3D is in use.

The options that are available for selection on the resulting dialog depend upon the design code selected from the dialog displayed when using the **Design> RC Frame Design** menu item.

The following design codes are currently supported:

- EN1992-1-1: 2004** - EN 1992-1-1:2004 Eurocode 3: Design of steel structures – Part 1-1: General rules and rules for buildings.
- EN1992-2: 2005** - EN1992-2: 2005 Eurocode 2: Design of concrete structures Part 2: Concrete bridges - Design and detailing rules.

Typical information defined in a RC frame design attribute includes:

- Beam and column minimum reinforcement ratios
- Calculation methodology

- Parameters for stress limitation and crack control
- Creep parameters

Once defined, a Design attribute entry is created in the Attributes  Treeview ready for assignment to selected lines in a model.

Note that the same RC frame design attribute is used for both EN 1992-1-1:2004 and EN1992-2:2005 design codes.

RC Frame Design Attribute Settings for EN1992-1-1: 2004 and EN1992-2: 2005

EN1992-1-1: 2004 and EN1992-2: 2005 RC frame design attributes can be defined by using the **Attributes > Design > RC Frame Design** menu item after previously selecting the relevant code from the **RC frame design code selection** dialog. After definition, RC frame design attributes need to be assigned to the appropriate lines in a model that represent concrete members.

General

Minimum and maximum reinforcement ratios must be stated for beam and column use. These are used for determination of utilisation, by way of the ratio $Util = A_{steel\ provided} / A_{steel\ required}$

Beam

- See Clause 9.2.1.1.

Column

- See Clause 9.5.2.

ULS

For calculating section capacity and utilisation of the section two methods are available:

- **The closest point to the interaction diagram** - This will always produce a result whether the forces are inside or outside the interaction diagram. Utilisation calculated using this method is more conservative than that calculated by the proportional increase of moments method, effectively giving the utilisation by accounting for possible variation of moments and/or axial force.
- **Proportional increase of moments** - In this method, the axial force is assumed fixed and the utilisation is based upon an increase in both orthogonal moment components M_y and M_z . This will only produce results if the internal forces are inside the interaction diagram. If no results are available calculations are automatically carried out using the closest point method.

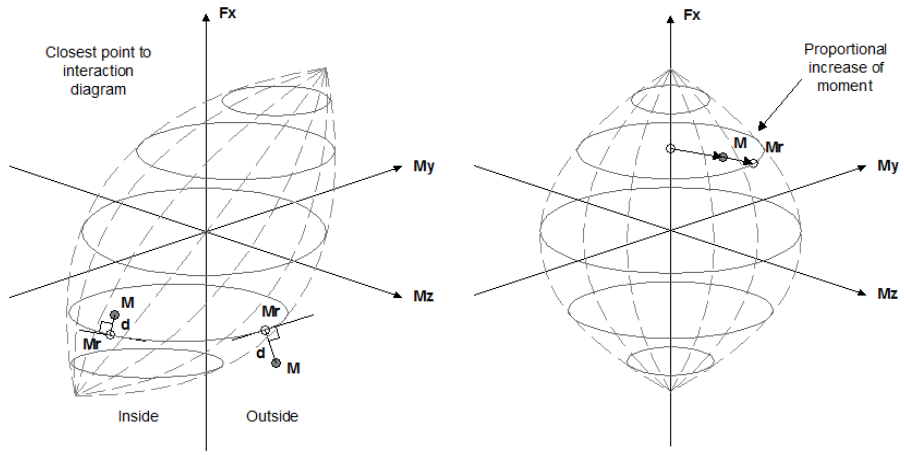

Closest point to the interaction diagram

Proportional increase of moments

Notes

- For the closest point to the interaction diagram when force is outside diagram, utilisation is calculated from $(M_r+d)/M_r$ giving a value greater than 1.
- For the closest point to the interaction diagram when force is inside diagram, utilisation is calculated from $M_r/(M_r+d)$ giving a value less than 1.
- For proportional increase of moment when force is inside diagram, utilisation is calculated from M/M_r giving a value less than 1.

SLS

For Serviceability Limit State calculations the following stress limitation parameters must be stated.

- Compressive stress limit parameter (k1)** Reference Clause 7.2 (2)
- Non-linear creep limit parameter (k2)** Reference Clause 7.2 (3)
- Tensile stress limit parameters (k3)** Reference Clause 7.2 (5)

Crack control parameters:

- Coefficient for bond properties (k1)** Reference Clause 7.3.4 (3)
- Coefficient for strain distribution (k2)** Reference Clause 7.3.4 (3). This coefficient can be automatically interpolated based on strains or user-defined.

- Coefficient for cover influence (k3a, k3b, k3c)** Reference Clause 7.3.4 (3). For most nations, $k_{3a}=3.4$, $k_{3b}=0$ and $k_{3c}=0$; but other values (as required by Sweden, Denmark and Greenland can be defined.
- Coefficient for bar diameter (k4)** Reference Clause 7.3.4 (3)
- Factor for duration of loads (kt)** Reference Clause 7.3.4 (2). This coefficient can be interpolated based on strains, or the user can define this parameter manually.

Creep

For creep calculations a creep coefficient and effective creep ratio must be stated.

- Creep coefficient (Phi)** - used to calculate quasi-permanent (long term) modulus of the concrete, where E_{cm} , as used in the calculation, is taken from material attribute.

Four methods are available to calculate the effective creep ratio (for more details see paragraph 4.5):

- Auto (interpolated, based on stresses)**
- Short-term loading (Effective creep ratio = 0)**
- Long-term loading (Effective creep ratio = Creep coefficient)**
- Interpolated, based on proportion** (between variable and permanent effects)

Name

- This defines the design attribute entry that is created in the Attributes  Treeview ready for assignment to selected lines representing reinforced concrete members in a model.

Summary of RC Frame Design Checks made to EN1992-1-1: 2004 and EN1992-2: 2005

Assignment of EN1992-1-1 and EN1992-2 RC frame design attributes to lines representing concrete members permits the following design checks to be carried out on the member cross-section:

- ULS Check - Section at Ultimate Moment Resistance
- ULS Loading - Section at ULS Loading
- SLS Stress Limitation Check - Uncracked Section
- SLS Stress Limitation Check - Cracked Section
- SLS Crack Control Check - Cracked Section
- Minimum Reinforcement Check (7.3.2) - Uncracked Section at Cracking

Forces

- Minimum Reinforcement Check (7.3.2) - Cracked Section at Cracking Forces

For more details of checks made see "Tabulating RC Frame Design results for EN1992-1-1 and EN1992-2" on page 545

Implementation Notes

- See [Implementation Notes for RC Frame Design Checks to EN1992-1-1 and EN1992-2](#) for more information.

Implementation Notes for RC Frame Design Checks to EN1992-1-1 and EN1992-2

Scope

The current implementation allows users to carry out design of reinforced concrete elements due to bending and axial force in ULS and SLS. It is based on bi-linear stress-strain relations for the ULS design of cross-sections for concrete.

Effective area of concrete

The effective area of concrete in tension surrounding the reinforcement is calculated in a direction orthogonal to the neutral axis.

Crack width calculations

BS EN 1992-1-1:2004 +A1 Eurocode 2: 7.3.4(3) Equation 7.12 is applicable to a rectangular cross-section with one layer of reinforcement. SLS formulas have been adapted to provide crack width calculations for arbitrary sections. In LUSAS, for crack width calculation purposes, all reinforced concrete sections are treated as arbitrary shaped sections.

RC Frame Interaction Surface Diagrams

RC frame design results can be viewed as an interaction surface diagram. The diagram can be plotted and viewed in 2D or 3D from coordinates that correspond to the values of the internal forces (M_y , M_z , F_x) for a selected section. A diagram key shows contours of axial force, with red lines indicating an axial compression capacity of the section, and blue lines indicating the tension capacity of the section. All points inside the interaction surface meet the ULS resistance requirements. All points outside the interaction surface do not meet the ULS resistance requirements.

When **tabulating RC frame design results** interaction surface diagrams can be created:

- ❑ **For a single location** - for a location defined by a line, element, internal point and section type within a model, considering just the internal forces for that location.
- ❑ **For all locations** - for all locations of a section type considering all the internal forces for all locations of that section.

Single location

When viewing detailed results for a selected row on the Summary page, pressing the **Resistance Interaction Surface** button will display an interaction surface diagram for that row's location. The black dotted line shows the M_y M_z contour for the applied axial force.

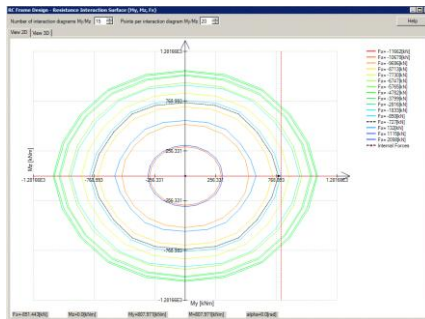

2D interaction surface diagram for a single location

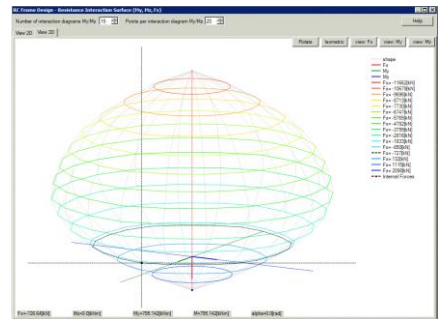

3D interaction surface diagram for a single location

Note that by reducing the number of interaction diagrams drawn to a value of 2 the M_y M_z plot for the applied axial force can be isolated

All locations

When viewing detailed results for a selected row on the ULS page, pressing the **Resistance Interaction Surface (All the internal forces included)** button will display an interaction surface diagram for all locations of a chosen section.

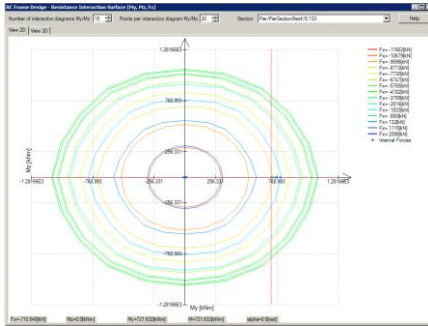

2D interaction surface diagram for all locations

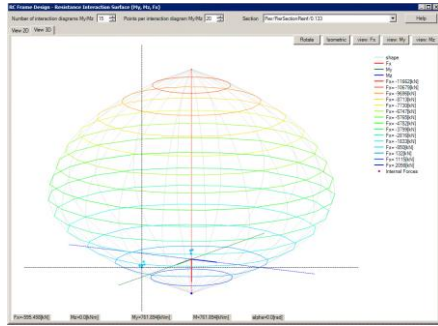

3D interaction surface diagram for all locations

Diagram viewing options

- Number of interaction diagrams M_y/M_z** - A number between 2 and 100, with a default value of 15.
- Points per interaction diagram M_y/M_z** - A number between 2 and 100, with a default value of 20.
- Section** - Displays the interaction surface for the geometric line attribute and reinforcement section chosen.

View related buttons (3D views only)

- Rotate** - Automatically rotate the influence diagram anti-clockwise. Press again to stop the rotation.
- Isometric** - View the influence diagram in an isometric view
- Fx, My, Mz** - Pre-defined views of the influence diagram along the Fx, My and Mz axes respectively

Mouse controls

Interaction diagrams can be inspected by zooming, panning and rotating within the view panel of the dialog.

- Use the mouse wheel to zoom in and out of the diagram.
- Click and hold-down the left mouse button to rotate the diagram.
- Click and hold-down the mouse wheel to pan the diagram.



Interrogating the diagram

Use the cursor to interrogate points drawn on the Interaction Surface diagram to see values for each internal force point.

Notes

Interaction surface diagrams are automatically added to a report if detailed results for ULS or summary results are added to a report.

Tabulating RC Frame Design results for EN1992-1-1 and EN1992-2

Detailed **RC frame design** results can be obtained by right-clicking on the RC frame design loadcase  in the Analyses  Treeview and selecting **Show Results**.

The results table displayed consists of a summary page and separate tabbed pages for each of the design checks requested in the RC Frame Design Check dialog.

Detailed results for a selected row are also available.

Summary and ULS Check results may also be viewed as an **interaction surface diagram**.

Summary results

The summary page table shows the location of the check (the line, element/inspection location, node/internal point/index, section), the utilisation of the sections at the stated location for each design check, and a maximum utilisation value coloured red for any over-utilised sections. For each location the maximum of loadcases included in the RC Frame Design loadcase is provided. A colour coded end column also provides an indication of utilisation capacities for each section location, with green showing under utilised sections and red showing over utilised sections.

The Section name in the table is formed from the names of the Geometric line attribute and the referenced line reinforcement attribute. When tabulating details for tapered members the Section name will also include a parametric distance value to indicate where along the length of line the section applies.

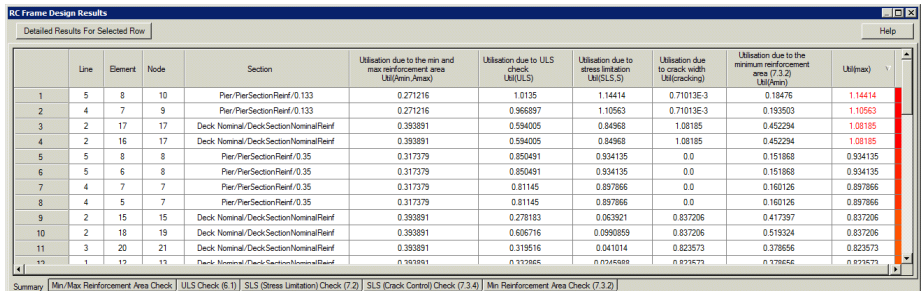

	Line	Element	Node	Section	Utilisation due to the min and max reinforcement area (Ult/min Area)	Utilisation due to ULS check (Ult/ULS)	Utilisation due to stress limitation (Ult/SLS)	Utilisation due to crack width (Ult/crackwidth)	Utilisation due to the minimum reinforcement area (7.3.2) (Ult/min)	Util(max)
1	5	8	10	Pier/PierSectionReinf/0.133	0.271216	1.0135	1.14414	0.71013E-3	0.18476	1.14414
2	4	7	9	Pier/PierSectionReinf/0.133	0.271216	0.966937	1.10563	0.71013E-3	0.151933	1.10563
3	2	17	17	Deck Nominal/DeckSectionNominalReinf	0.393891	0.594005	0.84968	1.08185	0.452294	1.08185
4	2	16	17	Deck Nominal/DeckSectionNominalReinf	0.393891	0.594005	0.84968	1.08185	0.452294	1.08185
5	5	8	8	Pier/PierSectionReinf/0.35	0.317379	0.850491	0.934135	0.0	0.151868	0.934135
6	5	6	8	Pier/PierSectionReinf/0.35	0.317379	0.850491	0.934135	0.0	0.151868	0.934135
7	4	7	7	Pier/PierSectionReinf/0.35	0.317379	0.81145	0.897866	0.0	0.160126	0.897866
8	4	5	7	Pier/PierSectionReinf/0.35	0.317379	0.81145	0.897866	0.0	0.160126	0.897866
9	2	15	15	Deck Nominal/DeckSectionNominalReinf	0.393891	0.278183	0.063921	0.837206	0.417397	0.837206
10	2	18	19	Deck Nominal/DeckSectionNominalReinf	0.393891	0.606716	0.099059	0.837206	0.519324	0.837206
11	3	20	21	Deck Nominal/DeckSectionNominalReinf	0.393891	0.319516	0.041014	0.823573	0.378656	0.823573
12	1	17	17	Deck Nominal/DeckSectionNominalReinf	0.393891	0.317865	0.045689	0.823573	0.378656	0.823573

When viewing detailed results for a Summary check, an interaction surface diagram can also be obtained. See **Obtaining detailed results for a selected row**.

Min/Max Area of Reinforcement Check

The Min/Max Area of Reinforcement Check is carried out in accordance with EN1992-1-1 cl 9.2.1.1 and 9.5.2.

Application Manual (Bridge, Civil & Structural)

The table contains information describing the location of the check (line, element/inspection location, node/internal point/index, section), information describing internal force taken to the check (load, primary component, internal forces (Fx, My, Mz)) and provides the following results:

- Concrete area A_c
- Reinforcement area A_s
- Reinforcement ratio ρ [%]
- Minimum cross sectional ratio of reinforcement ρ_{Min} [%]
- Maximum cross sectional ratio of reinforcement ρ_{Max} [%]
- Utilisation due to the min and max reinforcement area $\text{Util}(A_{\text{min}}, A_{\text{max}})$

RC Frame Design Results													
Detailed Results For Selected Row												Help	
Line	Element	Node	Section	Loadcase	Primary Component	Internal Forces Fx[kN]	Concrete area $A_c[m^2]$	Reinforcement area $A_s[m^2]$	Reinforcement ratio ρ [%]	Minimum cross sectional ratio of reinforcement ρ_{Min} [%]	Maximum cross sectional ratio of reinforcement ρ_{Max} [%]	Utilisation due to the min and max reinforcement area $\text{Util}(A_{\text{min}}, A_{\text{max}})$	
1	4	7	9	Pier/PierSectionReinf/0.133	ULS combination	Fmax, My, Mz	-550.236E3	0.4448	4.82549E-3	1.08487	0.2	4.0	0.271216
2	4	7	9	Pier/PierSectionReinf/0.133	ULS combination	Fmin, My, Mz	-710.548E3	0.4448	4.82549E-3	1.08487	0.2	4.0	0.271216
3	4	7	9	Pier/PierSectionReinf/0.133	ULS combination	Fx, Mymax, Mz	-899.922E3	0.4448	4.82549E-3	1.08487	0.2	4.0	0.271216
4	4	7	9	Pier/PierSectionReinf/0.133	ULS combination	Fx, Mymin, Mz	-353.436E3	0.4448	4.82549E-3	1.08487	0.2	4.0	0.271216
5	4	7	9	Pier/PierSectionReinf/0.133	ULS combination	Fx, My, Mzmax	-550.236E3	0.4448	4.82549E-3	1.08487	0.2	4.0	0.271216
6	4	7	9	Pier/PierSectionReinf/0.133	ULS combination	Fx, My, Mzmin	-703.122E3	0.4448	4.82549E-3	1.08487	0.2	4.0	0.271216
7	4	7	7	Pier/PierSectionReinf/0.35	ULS combination	Fmax, My, Mz	-562.95E3	0.380104	4.82549E-3	1.26952	0.2	4.0	0.317379
8	4	7	7	Pier/PierSectionReinf/0.35	ULS combination	Fmin, My, Mz	-715.901E3	0.380104	4.82549E-3	1.26952	0.2	4.0	0.317379
9	4	7	7	Pier/PierSectionReinf/0.35	ULS combination	Fx, Mymax, Mz	-912.637E3	0.380104	4.82549E-3	1.26952	0.2	4.0	0.317379
10	4	7	7	Pier/PierSectionReinf/0.35	ULS combination	Fx, Mymin, Mz	-358.789E3	0.380104	4.82549E-3	1.26952	0.2	4.0	0.317379
11	4	7	7	Pier/PierSectionReinf/0.35	ULS combination	Fx, My, Mzmax	-562.95E3	0.380104	4.82549E-3	1.26952	0.2	4.0	0.317379
12	4	7	7	Pier/PierSectionReinf/0.35	ULS combination	Fx, My, Mzmin	-703.122E3	0.380104	4.82549E-3	1.26952	0.2	4.0	0.317379
Summary: Min/Max Reinforcement Area Check ULS Check (6.1) SLS (Stress Limitation) Check (7.2) SLS (Crack Control) Check (7.3.4) Min Reinforcement Area Check (7.3.2)													

ULS Check - Section Capacity

The ULS Check is carried out in accordance with EN1992-1-1 clause 6.1 and provides the following results:

- Resistance Forces (Fx, My, Mz)
- Utilisation due to ULS check $\text{Util}(\text{ULS})$

RC Frame Design Results													
Detailed Results For Selected Row												Help	
Resistance Interaction Surface (all the internal forces included)													
Line	Element	Node	Section	Loadcase	Primary Component	Internal Forces Fx[kN]	Internal Forces My[kNm]	Internal Forces Mz[kNm]	Resistance Forces Fx[kN]	Resistance Forces My[kNm]	Resistance Forces Mz[kNm]	Utilisation due to ULS check $\text{Util}(\text{ULS})$	
1	5	8	10	Pier/PierSectionReinf/0.133	ULS combination	Fx, Mymax, Mz	-726.64E3	795.142E3	0.0	-726.627E3	784.552E3	89.7477E-6	1.0135
2	5	8	10	Pier/PierSectionReinf/0.133	ULS combination	Fx, My, Mzmin	-595.458E3	761.894E3	0.0	-595.622E3	760.02E3	90.0706E-6	1.00247
3	5	8	10	Pier/PierSectionReinf/0.133	ULS combination	Fmin, My, Mz	-779.18E3	794.679E3	0.0	-779.475E3	794.618E3	89.6858E-6	1.00010
4	4	7	9	Pier/PierSectionReinf/0.133	ULS combination	Fx, My, Mzmin	-703.122E3	794.626E3	0.0	-702.734E3	790.255E3	89.7886E-6	0.960897
5	4	7	9	Pier/PierSectionReinf/0.133	ULS combination	Fmin, My, Mz	-710.548E3	721.626E3	0.0	-711.067E3	731.82E3	89.7718E-6	0.923016
6	4	7	9	Pier/PierSectionReinf/0.133	ULS combination	Fx, Mymax, Mz	-899.922E3	731.491E3	0.0	-900.49E3	916.899E3	89.6957E-6	0.895328
7	5	8	8	Pier/PierSectionReinf/0.35	ULS combination	Fx, Mymax, Mz	-731.894E3	596.356E3	0.0	-731.966E3	701.19E3	-0.19282E-6	0.850491
8	5	8	8	Pier/PierSectionReinf/0.35	ULS combination	Fx, Mymin, Mz	-731.894E3	596.356E3	0.0	-731.966E3	701.19E3	-0.19282E-6	0.850491
9	5	8	8	Pier/PierSectionReinf/0.35	ULS combination	Fx, My, Mzmin	-600.812E3	571.421E3	0.0	-600.422E3	679.297E3	-0.193303E-6	0.841194
10	5	8	8	Pier/PierSectionReinf/0.35	ULS combination	Fx, My, Mzmin	-600.812E3	571.421E3	0.0	-600.422E3	679.297E3	-0.193303E-6	0.841194
11	5	8	8	Pier/PierSectionReinf/0.35	ULS combination	Fmin, My, Mz	-784.514E3	596.009E3	0.0	-784.347E3	709.787E3	-0.191106E-6	0.833701
12	5	8	8	Pier/PierSectionReinf/0.35	ULS combination	Fmin, My, Mz	-784.514E3	596.009E3	0.0	-784.347E3	709.787E3	-0.191106E-6	0.833701
Summary: Min/Max Reinforcement Area Check ULS Check (6.1) SLS (Stress Limitation) Check (7.2) SLS (Crack Control) Check (7.3.4) Min Reinforcement Area Check (7.3.2)													

Viewing results as an Interaction Surface Diagram

When viewing results for a ULS check an interaction surface diagram may also be created by pressing the **Interaction Surface (all the internal forces included)** button. When pressed, the interaction surface drawn represents the ULS resistance of a chosen section. The interaction surface can be viewed in 2D and 3D. See "RC Frame Interaction Surface Diagrams" on page 542 for details.

SLS Stress Limitation Check

SLS Stress Limitation Check is carried out in accordance with EN1992-1-1 clause 7.2 and provides the following results:

- Compressive stress in the concrete Sc
- Utilisation due to stress limitation in the concrete $Util(Sc)$
- Tensile stresses in the reinforcement Ss
- Utilisation due to stress limitation in the reinforcement $Util(Ss)$
- Utilisation due to stress limitation $Util(SLS,S) = \max (Util(Sc), Util(Ss))$

Line	Element	Node	Section	Loadcase	Primary Component	Internal Force P(kN)	Internal Force My(kNm)	Internal Force Mz(kNm)	Compressive stress in the concrete $Sc(kN/m^2)$	Utilisation due to stress limitation in the concrete $Util(Sc)$	Tensile stresses in the reinforcement $Ss(kN/m^2)$	Utilisation due to stress limitation in the reinforcement $Util(Ss)$	Utilisation due to stress limitation $Util(SLS,S)$	
1	5	8	10	Pier/PieSect...	SLS characteristic	Fx, My, Mzmin	-278.334E3	560.152E3	0.0	-24.5203E6	1.02168	457.658E6	1.14414	1.14414
2	5	8	10	Pier/PieSect...	SLS characteristic	Fmin, My, Mz	-414.409E3	584.437E3	0.0	-25.4887E6	1.06203	448.812E6	1.12203	1.12203
3	4	7	9	Pier/PieSect...	SLS characteristic	Fx, My, Mzmin	-358.085E3	563.048E3	0.0	-24.493E6	1.02054	442.25E6	1.10563	1.10563
4	4	7	9	Pier/PieSect...	SLS characteristic	Fmin, My, Mz	-363.585E3	538.756E3	0.0	-23.4193E6	0.975803	418.343E6	1.04586	1.04586
5	5	8	10	Pier/PieSect...	SLS characteristic	Fx, Mymax, Mz	-510.774E3	570.151E3	0.0	-24.7556E6	1.03149	413.538E6	1.03384	1.03384
6	5	8	8	Pier/PieSect...	SLS characteristic	Fmin, My, Mz	-414.409E3	438.328E3	0.0	-22.4192E6	0.934135	355.589E6	0.888973	0.934135
7	5	6	8	Pier/PieSect...	SLS characteristic	Fmin, My, Mz	-414.409E3	438.328E3	0.0	-22.4192E6	0.934135	355.589E6	0.888973	0.934135
8	4	7	9	Pier/PieSect...	SLS characteristic	Fx, Mymax, Mz	-702.954E3	522.784E3	0.0	-22.2805E6	0.928353	327.398E6	0.818496	0.928353
9	5	8	8	Pier/PieSect...	SLS characteristic	Fx, My, Mzmin	-278.334E3	420.114E3	0.0	-21.5688E6	0.896899	367.844E6	0.91961	0.91961
10	5	6	8	Pier/PieSect...	SLS characteristic	Fx, My, Mzmin	-278.334E3	420.114E3	0.0	-21.5688E6	0.896899	367.844E6	0.91961	0.91961
11	5	8	8	Pier/PieSect...	SLS characteristic	Fx, Mymax, Mz	-510.774E3	427.614E3	0.0	-21.7857E6	0.906905	323.121E6	0.807803	0.906905
12	4	6	9	Pier/PieSect...	SLS characteristic	Fx, Mymax, Mz	-610.221E3	422.614E3	0.0	-21.7857E6	0.906905	323.121E6	0.807803	0.906905

SLS Crack Control Check

The SLS Crack Control Check is carried out in accordance with EN1992-1-1 clause 7.3 and provides the following results:

- Limiting calculated crack width
- Crack width
- Utilisation due to crack width $Util(SLS,C)$

Application Manual (Bridge, Civil & Structural)

Line	Element	Node	Section	Loadcase	Primary Component	Internal Forces Fx(kN)	Internal Forces My(kN)	Internal Forces Mz(kN)	Internal Forces Fy(kN)	Internal Forces Fz(kN)	Limiting calculated crack width(w)	Crack width(w)	Utilisation due to crack width (Utilcracking)
1	2	17	17	Deck Nominal/Deck-SectionNominalR...	SLS GP	Fmax,My,Mz	-7.74299E3	596.821E3	0.0	596.821E3	0.3E-3	0.324554E-3	1.08185
2	2	17	17	Deck Nominal/Deck-SectionNominalR...	SLS GP	Fx,Mymax,Mz	-7.74299E3	596.821E3	0.0	596.821E3	0.3E-3	0.324554E-3	1.08185
3	2	16	17	Deck Nominal/Deck-SectionNominalR...	SLS GP	Fmax,My,Mz	-7.74299E3	596.821E3	0.0	596.821E3	0.3E-3	0.324554E-3	1.08185
4	2	16	17	Deck Nominal/Deck-SectionNominalR...	SLS GP	Fx,Mymax,Mz	-7.74299E3	596.821E3	0.0	596.821E3	0.3E-3	0.324554E-3	1.08185
5	2	15	15	Deck Nominal/Deck-SectionNominalR...	SLS GP	Fx,My,Mmax	-2.87657E3	613.057E3	0.0	613.057E3	0.3E-3	0.251162E-3	0.837206
6	2	15	15	Deck Nominal/Deck-SectionNominalR...	SLS GP	Fx,Mymin,Mz	-2.87657E3	613.057E3	0.0	613.057E3	0.3E-3	0.251162E-3	0.837206
7	2	18	19	Deck Nominal/Deck-SectionNominalR...	SLS GP	Fx,Mymin,Mz	-2.87657E3	613.057E3	0.0	613.057E3	0.3E-3	0.251162E-3	0.837206
8	2	18	19	Deck Nominal/Deck-SectionNominalR...	SLS GP	Fx,My,Mmax	-2.87657E3	613.057E3	0.0	613.057E3	0.3E-3	0.251162E-3	0.837206
9	1	12	13	Deck Nominal/Deck-SectionNominalR...	SLS GP	Fx,Mymax,Mz	0.0	452.165E3	0.0	452.165E3	0.3E-3	0.247073E-3	0.823573
10	3	20	21	Deck Nominal/Deck-SectionNominalR...	SLS GP	Fx,Mymax,Mz	0.0	452.165E3	0.0	452.165E3	0.3E-3	0.247073E-3	0.823573
11	3	21	21	Deck Nominal/Deck-SectionNominalR...	SLS GP	Fx,Mymax,Mz	0.0	452.165E3	0.0	452.165E3	0.3E-3	0.247073E-3	0.823573
12	1	13	13	Deck Nominal/Deck-SectionNominalR...	SLS GP	Fx,Mymax,Mz	0.0	452.165E3	0.0	452.165E3	0.3E-3	0.247073E-3	0.823573

Min Reinforcement Area Check

The Min Reinforcement Area Check is carried out in accordance with EN1992-1-1 clause 7.3.2 and provides the following results:

- Cracking forces (Fx, My, Mz)
- Tensile stresses sigR in the reinforcement resulting from the cracking forces
- Utilisation due to the minimum reinforcement area (7.3.2) Util(Amin)

Line	Element	Node	Section	Loadcase	Primary Component	Internal Forces Fx(kN)	Internal Forces My(kN)	Internal Forces Mz(kN)	Cracking forces Fx(kN)	Cracking forces My(kN)	Cracking forces Mz(kN)	Tensile stresses in the reinforcement at the cracking forces sigR(N/mm ²)	Utilisation due to the minimum reinforcement area (7.3.2) Util(Amin)	
1	2	18	19	Deck Nominal/Deck.S.	SLS characteristic	Fx,My,Mmax	-2.87657E3	613.057E3	0.0	-2.87657E3	1.05111E6	0.0	259.662E6	0.515224
2	2	18	19	Deck Nominal/Deck.S.	SLS characteristic	Fx,Mymin,Mz	-2.87657E3	613.057E3	0.0	-2.87657E3	1.05111E6	0.0	259.662E6	0.515224
3	2	18	19	Deck Nominal/Deck.S.	SLS characteristic	Fmax,My,Mz	-5.62509E3	528.905E3	0.0	-5.62509E3	1.05223E6	0.0	259.501E6	0.519022
4	2	18	19	Deck Nominal/Deck.S.	SLS characteristic	Fx,My,Mmin	-107.722E3	607.055E3	0.0	-107.722E3	1.09744E6	0.0	263.537E6	0.507075
5	2	18	19	Deck Nominal/Deck.S.	SLS characteristic	Fmax,My,Mz	-109.645E3	905.655E3	0.0	-109.645E3	1.09831E6	0.0	253.425E6	0.506851
6	2	18	19	Deck Nominal/Deck.S.	SLS characteristic	Fx,Mymax,Mz	-112.392E3	844.697E3	0.0	-112.392E3	1.09953E6	0.0	253.266E6	0.506531
7	1	14	15	Deck Nominal/Deck.S.	SLS characteristic	Fmax,My,Mz	0.0	595.797E3	0.0	0.0	931.718E3	0.0	231.708E6	0.463416
8	1	14	15	Deck Nominal/Deck.S.	SLS characteristic	Fx,Mymax,Mz	0.0	730.729E3	0.0	0.0	931.718E3	0.0	231.708E6	0.463416
9	1	14	15	Deck Nominal/Deck.S.	SLS characteristic	Fx,Mymin,Mz	0.0	595.797E3	0.0	0.0	931.718E3	0.0	231.708E6	0.463416
10	1	14	15	Deck Nominal/Deck.S.	SLS characteristic	Fx,My,Mmax	0.0	595.797E3	0.0	0.0	931.718E3	0.0	231.708E6	0.463416
11	2	16	17	Deck Nominal/Deck.S.	SLS characteristic	Fmax,My,Mz	45.1879E3	-828.093E3	0.0	45.1879E3	-545.327E3	-34.6277E-12	226.147E6	0.452294
12	2	16	17	Deck Nominal/Deck.S.	SLS characteristic	Fx,My,Mz	45.1879E3	-828.093E3	0.0	45.1879E3	-545.327E3	-34.6277E-12	226.147E6	0.452294

Obtaining detailed results for a selected row

For any page of the RC frame design results table, more detailed results can be obtained by double-clicking on a row of interest, or by pressing the **Detailed Results for Selected Row** button when the row of interest is highlighted. On the dialog presented, detailed results are listed in the left-hand panel. A cross-section chart is displayed in the right-hand panel.

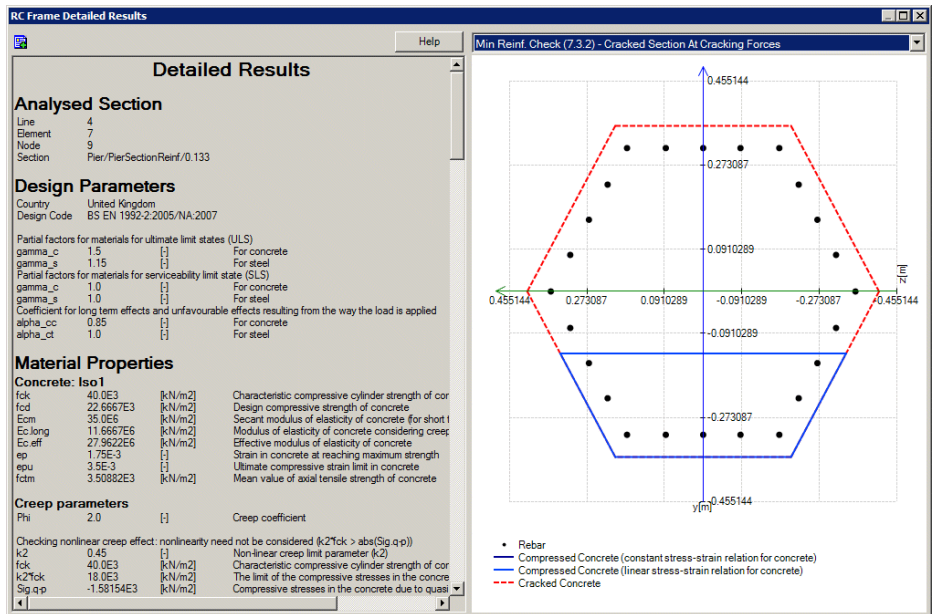

Detailed results

The content of the detailed results depends upon the tab displayed when the row on that page was selected.

- When accessing detailed results from the Summary page the appropriate cross-section diagram showing the extent of the cracked zone and compression zone in the section will need to be selected from the droplist provided.
- When one of the design check tabs such as ULS Check, or SLS (Crack Control) Check is selected the results related to the RC section and only the results related to the design check are listed, and only the cross-section chart for that selection can be drawn.
- In the Detailed Results panel, in the SLS Stress Limitation check section, a statement will be made according to whether a section is cracked or uncracked indicating whether a 'Cracked' or 'Uncracked' diagram showing the extent of the tension or compression in the section may be selected from the droplist.

Cross-section charts

The following cross-section charts can be drawn:

- ULS Check - Section at Ultimate Moment Resistance
- ULS Loading - Section at ULS Loading
- SLS Stress Limitation Check - Uncracked Section

- SLS Stress Limitation Check - Cracked Section
- SLS Crack Control Check - Cracked Section
- Minimum Reinforcement Check (7.3.2) - Uncracked Section at Cracking Forces
- Minimum Reinforcement Check (7.3.2) - Cracked Section at Cracking Forces

For the chosen location, the charts show (when applicable) the rebar arrangement, neutral axis, the compression part of the concrete (linear stress-strain relation for concrete at SLS), the compression part of the concrete (rectangular stress block at ULS) and the tension (cracked/uncracked) part of the concrete.

Viewing results as an Interaction Surface Diagram

When viewing detailed results for a Summary check, an **interaction surface diagram** can be obtained by double-clicking on a row of interest, or by pressing the **Resistance Interaction Surface** button when the row of interest is highlighted. When pressed, the interaction surface drawn represents the ULS resistance of a chosen section. The interaction surface diagram can be viewed in 2D and 3D, and is automatically added to a report if detailed results for ULS or summary results are added to a report.

Exporting data for Composite Deck Design

Overview

By using the **Design> Export to Composite Deck Design...** menu item relevant LUSAS model file and results data for a selected analysis and for pre-selected elements can be exported for use in the Steel and Composite Deck Designer software option. In exporting the forces and moments LUSAS will use the Dataset name of the assigned geometric attribute to determine if the section is cracked (see below). The Analysis from which the geometric features are to be used must be specified in the Analysis selection dialog before the main export dialog is launched.

Prior to exporting data from LUSAS a model must be solved and the beam elements for which forces and moments are to be exported should be selected. The selected elements should coincide with the sections (or changes of section) at which design checks will be undertaken in the Steel and Composite Deck Designer. The forces and moments will be exported for the first and last Gauss point of each element.

Selected Sections

The sections listed on the Selected Sections page of the dialog are based upon the elements selected prior to selecting the **Bridge> Composite Deck Designer...** menu item.

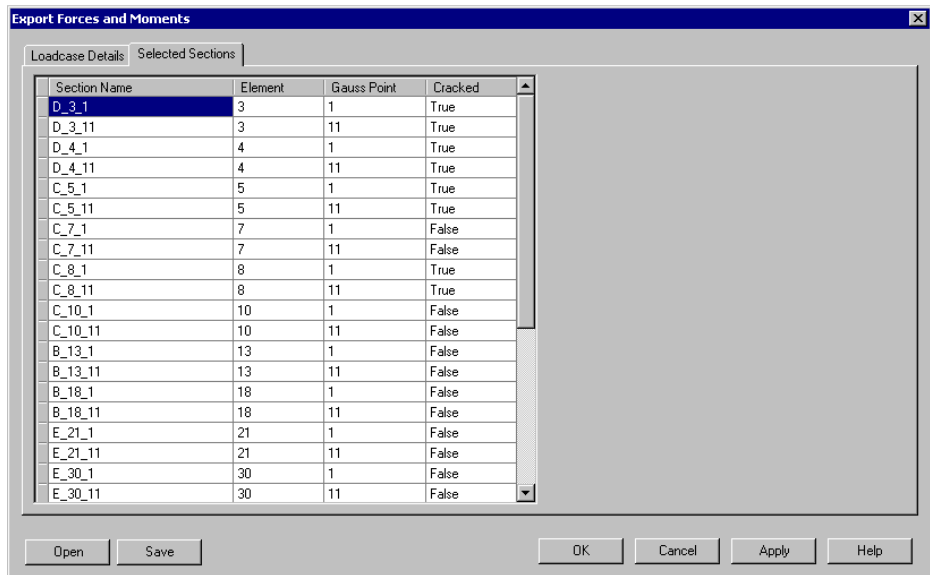

Notes

- For each selected element in the model, the table defines two sections, representing the first and last Gauss points. Each section has the following information: section name, element name (number), gauss point number, section name, and cracked/uncracked section status.
- Section names are created from: “[Segment Name]+“_”+ “[Element number]+“_”+[Gauss Point Number]
- The segment and the phase name are derived from the assigned geometric attribute, by splitting the attribute name on the double underscore separator “_”. For this reason the cross-section geometric properties in the LUSAS model should have a name that follows this standard: [Segment Name] +”_”+ [Phase name]; furthermore the phase name should be: {F1, F2a, F2b, F3a, F3b, cracked}.
- The cracked status of the section is a Boolean value taken as true when the phase name is “cracked” and false otherwise.

Forces and moments will be exported for each of the sections listed and for each design combination and construction phase selected on the Loadcase details page.

Loadcase Details

On the Loadcase Details page of the dialog the loadcase combinations defined within LUSAS are associated with design limit states and phases defined in the Steel and

Composite Deck Designer. For each mapped Smart Combination, maximum and minimum values will be exported for each of the selected force components. This allows the maximum design values to be computed accounting for all relevant load factors. The shrinkage/thermal coefficients will be exported for all non-cracked sections (see below).

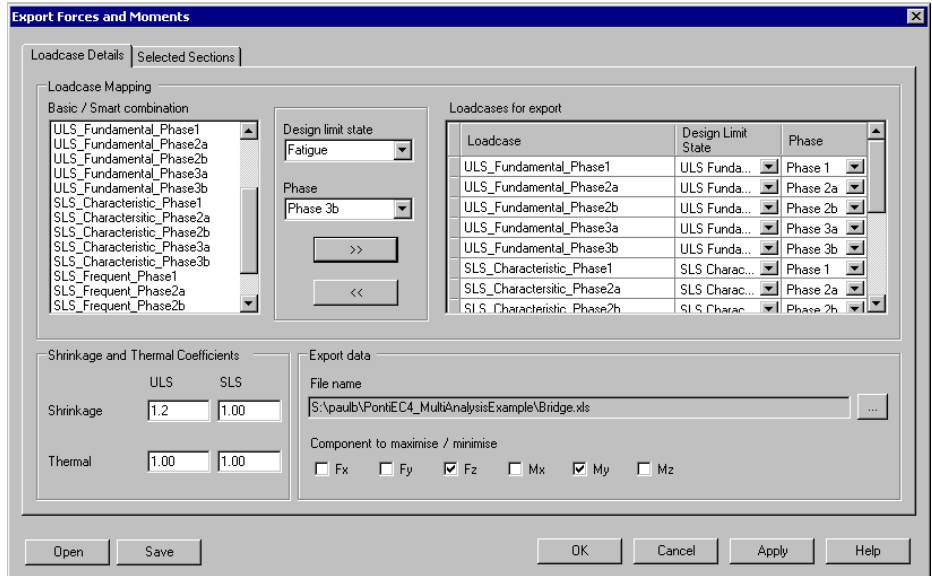

Notes

- To map a Basic or Smart combination select it in the left hand panel, choose a Design limit state and a Phase from the drop-down lists provided, and click the >> button to add it to the Loadcase for Export grid on the right.
- **Shrinkage and Thermal Coefficients** can be defined for the Ultimate Limit State and Serviceability Limit State. The thermal and shrinkage coefficients are used by the Steel and Composite Deck designer in calculating the primary effects due to shrinkage and thermal actions in uncracked sections only (identified by the word 'False' in the cracked column of the Selected Sections Table). The hyperstatic (secondary) effects are determined from the LUSAS analysis. These same factors should therefore be specified separately in the relevant LUSAS smart combination
- **Component to maximise / minimise** are the components that will be considered in the smart combination

Saving and re-using defined data

- The **Save** button saves all Defined Loadcase Details and Selected Sections data to a input file with a .inp extension.
- The **Open** button will allow a previously saved input file to be chosen and re-populate the dialog pages with the data in that file.

Exporting data

- Assembled data can be exported into a spreadsheet for use by the Steel and Composite Deck Designer by pressing the **OK** button. The ellipsis button can be used to change folder and filename. Typical output is shown below.

1	2	3	4	5	6	7	8	9	10	11	12			
1	Ponti EC4													
2	Section	Element	GaussPt	Component	Phase	N	Fx	Fy	Fz	T	Mx	My	Mz	γ ψ
3	D_3_1	3	1	Fz (Max)	Phase 1	4.2940E+04	1.7073E+02	2.4724E+06	-1.0750E+02	2.4513E+07	6.1363E+02			
4	D_3_11	3	11	Fz (Max)	Phase 1	4.2940E+04	1.7073E+02	2.4878E+06	-1.0750E+02	2.6684E+07	7.6307E+02			
5	D_4_1	4	1	Fz (Max)	Phase 1	4.2938E+04	2.2986E+01	2.2245E+06	-1.0540E+02	1.7175E+07	2.7736E+02			
6	D_4_11	4	11	Fz (Max)	Phase 1	4.2938E+04	2.2986E+01	2.2496E+06	-1.0540E+02	2.0361E+07	3.1009E+02			
7	C_5_1	5	1	Fz (Max)	Phase 1	4.2938E+04	2.2986E+01	2.1242E+06	-1.0164E+02	1.4620E+07	2.4973E+02			
8	C_5_11	5	11	Fz (Max)	Phase 1	4.2938E+04	2.2986E+01	2.1392E+06	-1.0164E+02	1.7182E+07	2.7736E+02			
9	C_7_1	7	1	Fz (Max)	Phase 1	4.2933E+04	5.1090E+00	1.8640E+06	-1.1520E+02	8.4254E+06	2.1987E+02			
10	C_7_11	7	11	Fz (Max)	Phase 1	4.2933E+04	5.1090E+00	1.8745E+06	-1.1520E+02	9.9922E+06	2.2416E+02			
11	C_8_1	8	1	Fz (Max)	Phase 1	4.2933E+04	5.1090E+00	1.9395E+06	-1.1520E+02	9.9922E+06	2.2416E+02			
12	C_8_11	8	11	Fz (Max)	Phase 1	4.2933E+04	5.1090E+00	1.9539E+06	-1.1520E+02	1.2254E+07	2.3009E+02			

The output file can be read directly into the Steel and Composite Deck Designer to carry out section design checks.

The Steel and Composite Deck Designer

The Steel and Composite Deck Designer is a software option that carries out comprehensive calculations for multiple sections on steel/composite bridge decks to the Eurocodes, allowing otherwise time-consuming and error-prone manual design calculations to be carried out efficiently. Force and moment results for selected bridge deck elements are provided by LUSAS and loadcase combinations defined within LUSAS are associated with design limit states and phases defined in the Composite Deck Designer.

Design calculations covering ULS bending, stress, shear and interaction; SLS stress, web breathing and cracking, and fatigue checks for main members and connectors are supported in the Composite Deck Designer. Multiple sections with different properties (haunches, stiffeners, etc) can be considered. Results, output in tabbed dialogs, visually show values that pass or fail. Graphs and a report containing all input data and output with references to the Eurocode clauses can be easily created.

Design checks for a number of construction phases are supported:

- Phase 1 – Self weight

- Phase 2a – Permanent loads
- Phase 2b – Concrete Shrinkage
- Phase 2c – Imposed deformations/prestressing
- Phase 3a – Thermal actions
- Phase 3 b – Traffic loads

For each construction phase design checks are made for each of the following combinations:

- ULS Fundamental – EN 1990 6.4.3.2 (3)
- SLS Characteristic – EN 1990 6.5.3 (2a)
- SLS Frequent – EN 1990 6.5.3 (2b)
- Fatigue – EN 1992-1-1 6.8.3

See [Exporting data for use with the Composite Deck Designer](#).

Additional information

For more details on the Composite Deck Designer visit the LUSAS website.

Index

A

AASHTO, 91
AASHTO LRFD
 defining tendon properties, 331,
 341, 343
Abnormal Indivisible Loads, 89, 91
AS5100, 125, 130
AS5100-2, 125, 130
As5100-7, 125, 130
Australia Vehicle Loading, 30

B

box sections
 section propety calculation, 13
bridge loading, 27
BS5400
 defining tendon properties, 347
buckling lengths
 defining, 406

C

cable tuning analysis, 301, 309
 linear, 301
 nonlinear, 306

camber table, 383
case study
 cable stay analysis, 305, 308
China Vehicle Loading, 35
combination
 design code based, 259
Composite deck design, 554
compound material
 reinforced concrete, 536
concrete (reinforced), 536
construction tables, 383

D

defining member buckling lengths,
406
Denmark Vehicle Loading, 37
derived components, 393, 522
design code check summary
 adding to a main report, 398

E

EN1991-2
 2003 Optional Code Settings, 247
 2003 optional code settings
 (advanced), 250
EN1992-1-1
 1992 Eurocode 2

- defining tendon properties,
335, 348, 352
- Encased sections
 - calculation of properties, 21, 24
- Eurocode Train Loading, 42
- Eurocode Vehicle Loading, 39
- Export
 - force and moment data for use by
the Composite Deck Designer, 551

F

- Finland Vehicle Loading, 45

G

- Gravity Loading, 27
- grillage wizard, 7

H

- HA Loads, 81
- HA/HB loading, 81
- HB Vehicle, 84

I

- India Vehicle Loading, 49
- Infill sections
 - calculation of properties, 21
- influence shapes
 - viewing, 112
- interaction surface diagram
 - rc frame design, 542
- IRC

- 112-2011
 - defining tendon properties,
338
- Israel Vehicle Loading, 51

J

- JTG D62-2004
 - defining tendon properties, 355

K

- Korea Vehicle Loading, 54

L

- LFD, 91
- LFRD, 91
- line reinforcement, 532
- Loadcases
 - creating nonlinear cable tuning,
306
- loading, 27

M

- material models, 536
- member report
 - adding to a main report, 399
- moving load generation
 - in general, 105

N

- New Zealand Vehicle Loading, 60

Norway Vehicle Loading, 63
 NR-GN-CIV-025 Optional Code
 Settings, 255

O

Onerous effects, 122, 238
 onerous effects table, 122, 238
 Oregon truck loading, 98

P

pedestrian loading, 109
 Plate sections
 calculation of properties, 24
 Poland Vehicle Loading, 66
 PontiEC4, 554
 Precast beam sections
 calculation of properties, 11
 prestress
 calculation of losses, 328
 definition from a spreadsheet, 370
 legacy models, 325
 prestress loading
 editing, 324
 prestress modelling
 an overview, 323

R

rail load optimisation, 229
 analysis, 231
 Rail load optimisation, 234
 Rail Track Analysis, 373, 374
 rail track load patterns
 viewing, 233

rc frame design, 515
 bar spacing and crack width
 calculation, 532
 code selection, 537
 line reinforcement, 532
 section reinforcement, 524
 specify and view results, 518
 tabulating results, 545
 rc frame design check
 procedure, 516
 rc frame design code attributes, 538
 RC slab design
 overview, 449
 viewing results, 509
 rc slab designer
 background to calculations, 506
 reinforcement
 line beams, 532
 sections, 524
 sls design contours, 511
 Reinforcement
 uls design contours, 510
 RLO, 229, 234, 238

S

section reinforcement, 524
 solution types, 309
 South Africa Loading, 67
 staged construction
 time management, 319
 steel design code attributes, 405
 steel design code checking, 389
 Steel design summary results, 397
 steel frame design
 code selection, 404
 steel frame design check
 prior to carrying out, 389
 superposition
 vehicle load optimisation, 115, 233

Surface Loading, 27
Sweden vehicle loading, 71

T

tendon profile
 definition, 357
time dependent prestress, 323
time management
 staged construction, 319
TLO, 116
track definition, 240
track layout
 defining, 245
Track-Structure Interaction, 373
Train Loading, 42

U

UIC 776-01-R code settings, 252
UIC 776-1 code settings (advanced),
253
UIC774-3, 373

United Kingdom Special Vehicle
Loads, 85, 87
United Kingdom Train Loading, 89
United Kingdom Vehicle Loading, 81
United States of America Vehicle
Loading, 91
user-defined vehicle, 227
utilisation ratios, 396, 522

V

vehicle
 user defined, 227
vehicle load optimisation, 111
 analysis, 113
Vehicle load optimisation, 115
vehicle load patterns
 viewing, 113
vehicle loading, 105
VLO, 111, 115, 122

W

West Viginia truck loading, 103



LUSAS

LUSAS, Forge House, 66 High Street, Kingston upon Thames, Surrey, KT1 1HN, UK
Tel: +44 (0)20 8541 1999 | Fax: +44 (0)20 8549 9399 | info@lusas.com | www.lusas.com