

# Drained Nonlinear Analysis of an Retaining Wall

For LUSAS version:	19.0
For software product(s):	Any Plus version.
With product option(s):	Nonlinear
Note: The example exceeds the limits of the LUSAS Teaching and Training Version.	

## Description

The behaviour of a single propped retaining wall is to be investigated as soil is excavated in layers adjacent to it. Drained soil parameters are used throughout.

Horizontal displacement of the soil mass is restrained at its left and right hand edges, and both horizontal and vertical displacement is restrained at the base of the soil as the soil rests on solid rock.

The wall is 'wished-in-place' meaning that construction of the wall is not modelled.

Units of kN, m, t, s, C are used throughout.

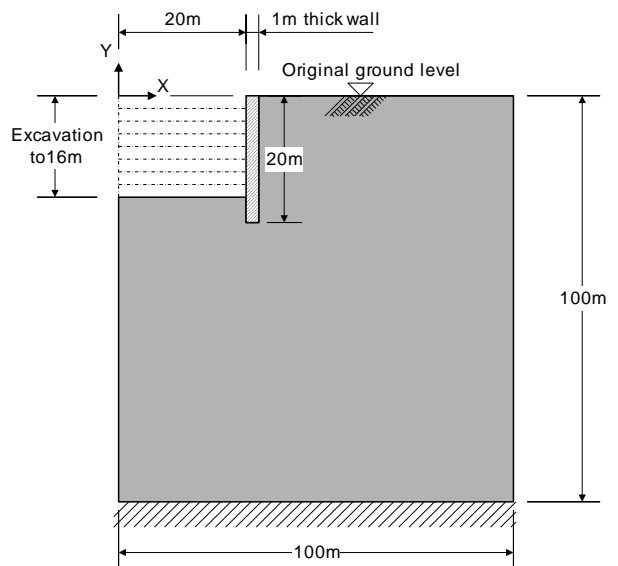

## Drained Nonlinear Analysis of an Retaining Wall

---

This example is based upon a published example, but uses simplified geometry to represent soil layers, and different material properties.

### Objectives

The required output from the analysis consists of:

- Displacement of the wall toe towards the excavation
- Surface heave immediately behind the wall
- Contours of plastic strain around the excavation
- Prop force per m length of wall
- Bending moment in the wall at 10m depth

### Keywords

**2D, Inplane, Retaining wall, Drained, Nonlinear, Excavation, Surface heave, Plane strain, Prop force, Bending Moment, Profile variation, Initial Soil stress,  $K_0$ , Initialisation.**

### Associated Files



- drained\_wall\_modelling.vbs** carries out the modelling of the example.

## Modelling

### Running LUSAS Modeller

For details of how to run LUSAS Modeller, see the heading *Running LUSAS Modeller* in the Examples Manual Introduction.



**Note.** This example is written assuming a new LUSAS Modeller session has been started. If continuing from an existing Modeller session select the menu command **File > New** to start a new model file.

### Creating a new model

- Enter a File name of **drained\_wall**
- Use the default User-defined working folder.
- Ensure an Analysis type of **Structural** is set.
- Select an Analysis Category of **2D Inplane**
- Set Model units of **kN,m,t,s,C**
- Leave the Timescale units as **Seconds**

- Select a Startup template of **None**
- Ensure the Layout grid is set as **None**
- Enter a Title of **Drained analysis of a propped retaining wall**
- Click the **OK** button.



**Note.** For a 2D Inplane analysis category the vertical axis is set to be the Y-axis.

## Mesh Definition

The surfaces are to be meshed using plane-strain quadrilaterals with a quadratic interpolation order (QPN8).

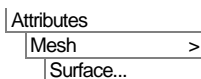

- Select the **Plane Strain, Quadrilateral, Quadratic** elements. Ensure the **Regular mesh** option is selected with **Automatic divisions** so that Modeller uses the mesh divisions assigned to each line.
- Give the attribute the name **Plane Strain quads** and click the **OK** button to add the mesh attribute to the Treeview.
- In the Treeview click on the mesh attribute **Plane Strain quads** with the right-hand mouse button and select the **Set Default** option. This will ensure all newly created surfaces will be assigned the elements defined in this mesh attribute.

## Profile Variation

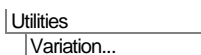

The Young's Modulus of the soil varies with depth and is described by a Profile Variation. It varies linearly from a value of  $0\text{kN/m}^2$  at the surface to  $6\text{E}5\text{kN/m}^2$  at a depth of 100m.

- Select **Profile Variation** and press **Next**.
- Select **New...** and enter the values of Distance (x) **0** Value (y) **0**, Distance (x) **100** Value (y) **6E5** in the Line Profile Variation dialogue box which appears. Enter **E\_LineP** for the line profile name and click **OK**.
- In the Available panel; of the dialog, select the line profile named **E\_LineP** by left clicking on it and then click on the 'Add to' button to transfer it to the profile set. The origin of the profile line is by default x origin 0.0, y origin 0.0 and so does not need to be changed. Similarly, the positive direction of the line profile is, by default, the negative vertical and again does not need modification.
- Enter the name **E\_mod** for profile variation and click **Finish**.

### Feature Geometry

For clarity, the display of the mesh layer will be turned off whilst the geometry of the model is created.

- In the  Treeview, right-click on the **Mesh** entry and select **On/Off**.

### Modelling

The model will be developed ‘top-down’ with surface features of a thickness to representing each soil layer in the excavated region being defined first. Then, the remainder of the soil mass will be generated by manipulating the initial geometry that is defined.

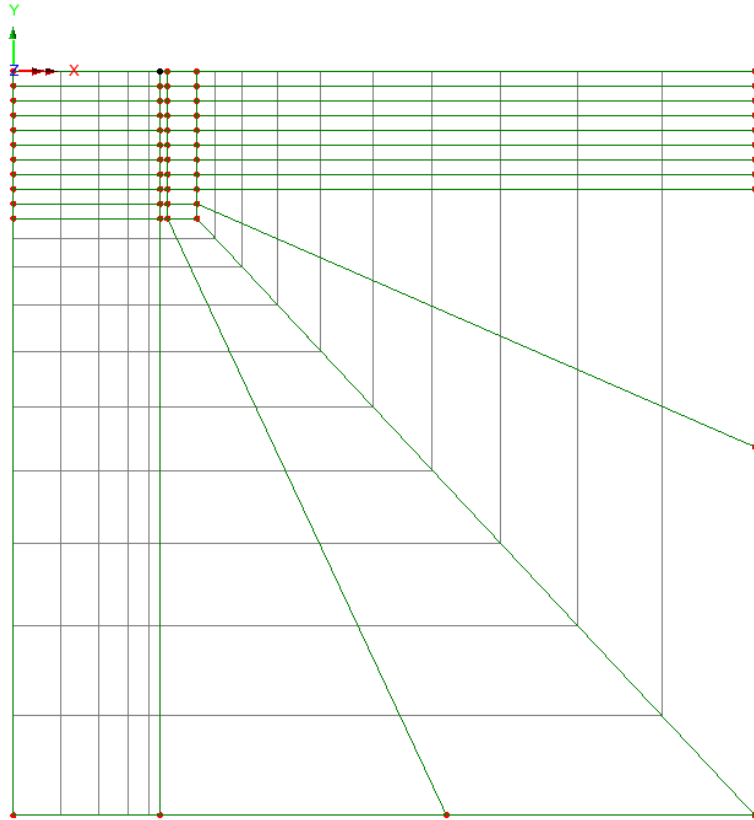

First, a series of horizontal lines defining the width of the excavation, wall and upper soil mass is to be defined:

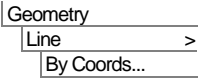

Enter the coordinates shown in the table to define four lines representing the original ground level (all Z coordinates should be zero or left blank). Use the Tab key to move to the next entry field on the dialog. When all coordinates have been entered click the **OK** button.

X	Y
0	0
20	0
21	0
25	0
100	0

These lines will then be swept vertically downwards to create a surface that represents the depth of the first excavated section:

- Press **CTRL-A** to select all the Lines just drawn.

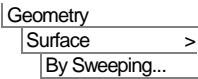

Ensure the **Translate** option is selected and enter a value of **-2.0** in **Y**.

- Click **OK** to sweep the Lines to create the Surfaces.
- Select the bottom four horizontal lines by clicking and dragging a selection box around them as shown below:

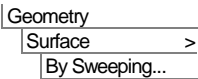
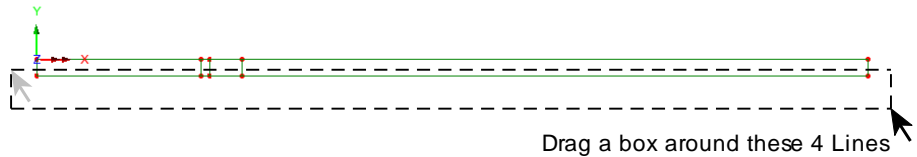

Ensure the **Translate** option is selected and enter a value of **-2.0** in **Y**.

- Click **OK** to sweep the Lines to create the Surfaces.
- Repeat the preceding commands eight more times, selecting the bottom four lines of the model each time and sweeping the lines by **-2.0** in **Y** each time as shown above to create surfaces that each correspond to the depth of each excavated portion.

To start to generate the remainder of the soil mass downwards:



## Drained Nonlinear Analysis of an Retaining Wall

---

- Select Point A shown.

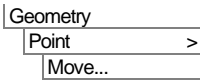

Ensure the **Translate** option is selected and enter a value of **-80** in **Y**.

- Click **OK** to move the Point.
- Select Point B shown in the previous image.

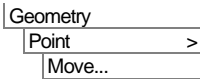

Ensure the **Translate** option is selected and enter a value of **-33** in **Y**.

- Click **OK** to move the Point.
- Box-select the two Lines shown by clicking and drag a selection box around those features. If necessary zoom in to make the selection easier.

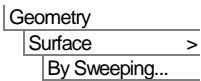

Ensure the **Translate** option is selected and enter a value of **-81** in **Y**.

- Click **OK** to sweep the Lines to create the Surfaces.

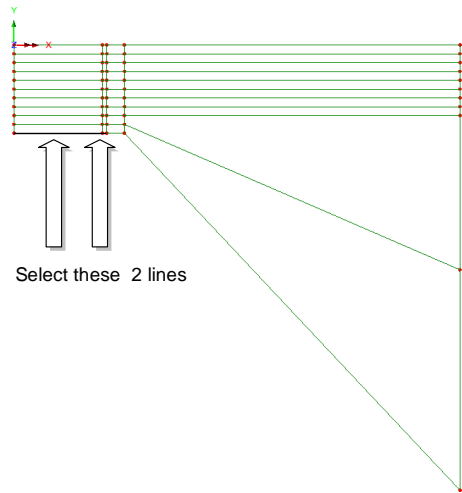

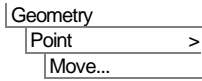

- Select the Point shown.
-  Ensure the **Translate** option is selected and enter a value of **38** in **X**.
- Click **OK** to move the Point.

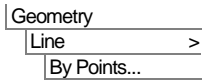
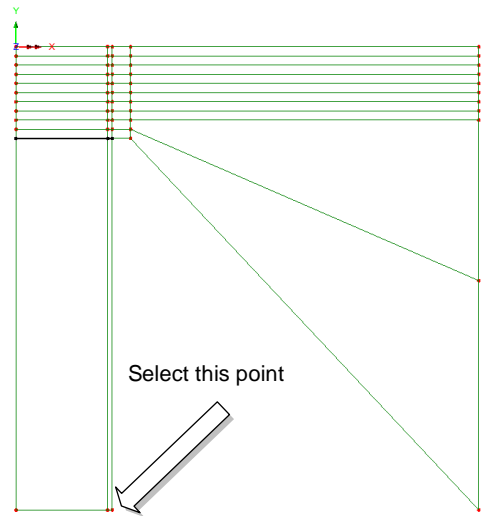

- Select the two Points shown.
-  Create a Line between the two selected Points.

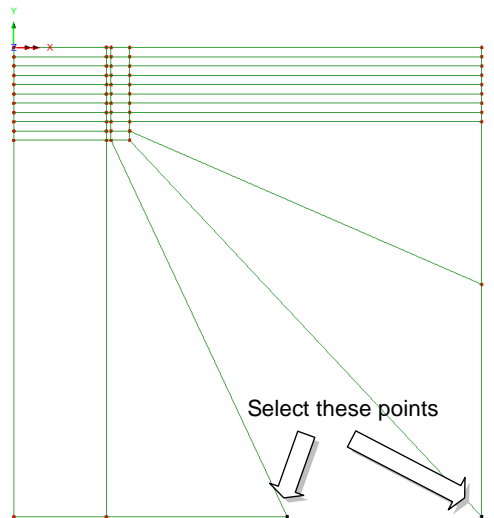

## Drained Nonlinear Analysis of an Retaining Wall

---

- Select the Line just drawn along with the three Lines as shown right.



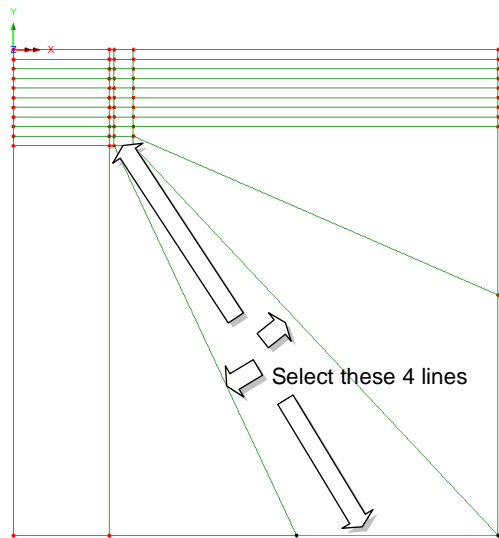
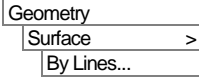

Create a Surface from the four selected Lines.



### Mesh Grading

The mesh for the soil mass will be graded away from the retaining wall. Three line mesh attributes will be created to do this.

- Define a Line mesh with element type **None** and **1** division.
- Enter the attribute name as **Null 1** and click the **Apply** button to add the attribute to the  Treeview and keep the dialog active.
- Set the number of divisions to be **5**.
- Select the **Spacing** button.
- Select the **Uniform transition** option and set the Ratio of first to last element to **4**
- Click **OK** to accept the spacing properties.
- Enter the attribute name as **Null 5 Graded** and click **Apply** to add the attribute to the  Treeview and keep the dialog active.
- Change the number of divisions to be **10**.
- Select the **Spacing** button.
- Select the **Uniform transition** option and set the Ratio of first to last element to **0.2**
- Click **OK** to accept the spacing properties.

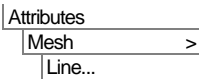





- Enter the attribute name as **Null 10 Graded** and click **OK** to add the attribute to the  Treeview.

## Assigning the mesh attributes

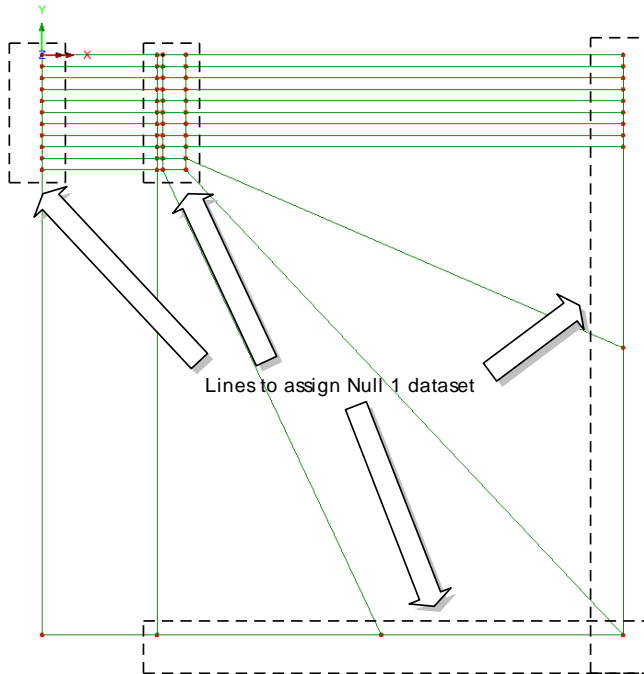
### Line mesh null 1



- Box-select the lines as shown and drag and drop the line mesh attribute **Null 1** from the  Treeview to assign it to the selected features.

### Line mesh null 5 graded

The selection of some of the sets of lines as shown in the next two images is best done by changing the selection cursor and additionally using a special keyboard shortcut which causes any lines passing through a box-selection to be selected.

To prepare for this:



Change the cursor to the 'Select Lines' cursor.

- Hold down the **ALT** key and drag a cursor box-selection through each set of horizontal lines as shown and then assign the mesh attribute **Null 5 Graded**.



**Note.** Pressing the **Shift** key at the same time as the **ALT** key will allow extra lines to be added to the initial selection.

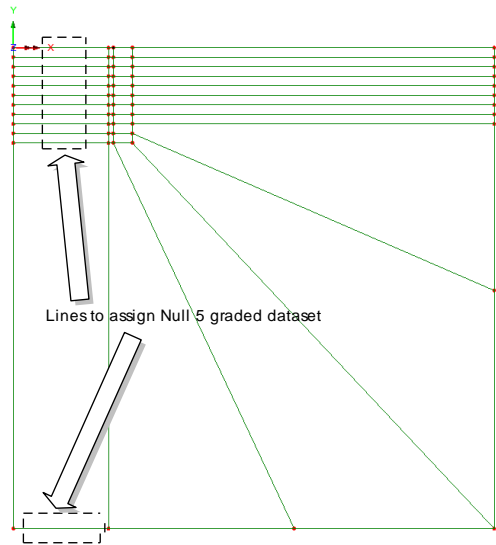



### Line mesh null 10 graded

- Hold down the **ALT** key to box-select the remaining lines as shown and assign the mesh attribute **Null 10 Graded**.

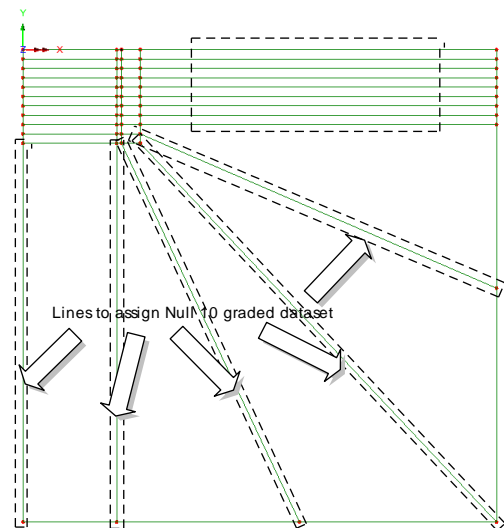

**Note.** See the *Keyboard Shortcut Guide* for more details on the use of keyboard shortcuts.



- Turn on the **Mesh** layer in the  Treeview to see the mesh.

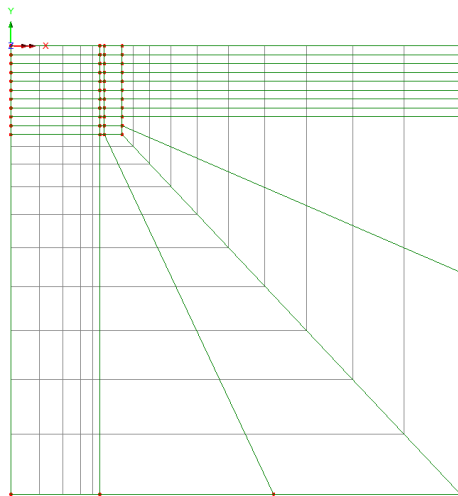

**Note.** If the mesh is graded with the smaller elements at the wrong end of a line reverse the line by selecting the line using the **Geometry> Line> Reverse** menu selection. If errors have been made in mesh assignments simply re-select any lines with an incorrect mesh assignment and re-assign the correct line mesh.

## Material Properties

An isotropic elastic material will be used for the concrete retaining wall while an isotropic nonlinear material utilising the Mohr-Coulomb failure surface will be used for the soil. The initial stress state in the soil is defined by assigning a coefficient for lateral earth pressure,  $K_0$ , to the soil.

### Concrete

- With the **Elastic** tab selected enter the isotropic material properties for the wall as Young's Modulus **28E6** kN/m<sup>2</sup>, Poisson's Ratio **0.15** and Mass Density **2.4** tonne/m<sup>3</sup>.
- Enter the attribute name as **Concrete Wall**
- Click the **OK** button to add the attribute to the  Treeview.

### Soil

- With the **Elastic** tab on the dialog selected, enter the isotropic material properties for the soil as follows:
- First, in the grid location for the Young's modulus, enter **1** and click on the  button. Select the **E\_mod** variation from the drop down list and click **OK**. The

Attributes  
Materials  
Isotropic...

Attributes  
Materials  
Geotechnical  
Mohr-Coulomb...

## Drained Nonlinear Analysis of an Retaining Wall

---

**1\*E\_mod** that is entered on the parent dialog indicates that the Young's Modulus is defined by a Profile variation scaled by a factor of **1**.

- Then enter a Poisson's Ratio of **0.2** and a Mass Density of **2.0** tonne/m<sup>3</sup>.
- Click the **Plastic** option and from the Model drop-down list select the **Mohr-Coulomb (model 65)** entry.
- Enter an **Initial cohesion** value of **0**
- Enter an **Initial friction angle** value of **25**
- Enter an **Final friction angle** value of **25**
- Enter a **Dilation angle** value of **5**
- In the Hardening panel, enter a **Cohesion hardening** value of **0**
- In the Hardening panel, enter a **Limiting plastic strain value** of **1000**
- Select the **Ko Initialisation** tab, and ensure that the 'Coefficient of lateral earth pressure' is set to be **0.5**
- Enter the attribute name as **Nonlinear Soil**
- Click the **OK** button to add the attribute to the  Treeview.

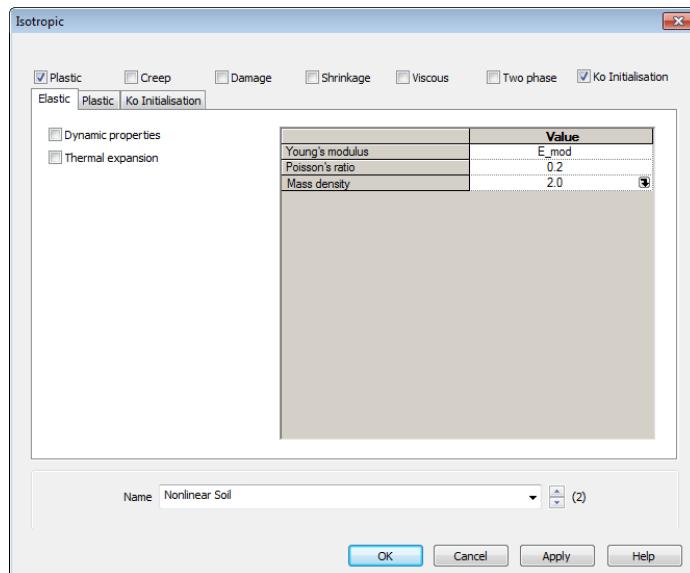

## Assigning material properties

To assign the material properties, groups will be used. Groups are very useful in allowing features of the model to be turned-on and off to aid the assignment of attributes or the viewing of results on selected features of the model.



Change the cursor back to the 'Select All' cursor.

### Wall

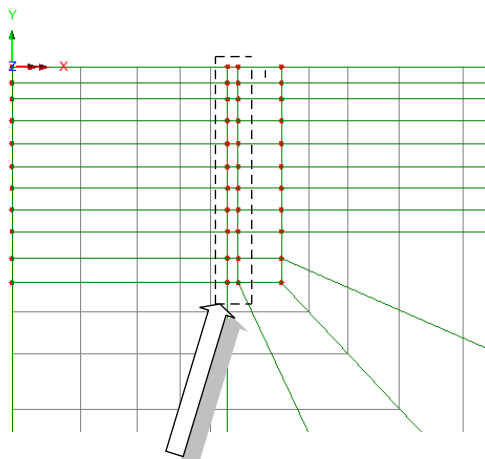

- Select the ten surfaces that form the retaining wall as shown.

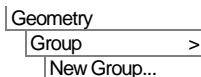

Select these surfaces to assign Concrete Wall material



Create a group containing the wall elements only and rename it **Wall**. Click **OK**.

- With the ten surfaces of the wall still selected drag and drop the material attribute **Concrete Wall** from the  Treeview onto the selection. With the **Assign to surfaces** option selected, click **OK** to assign the material attribute.
- In the  Treeview right-click on the **Wall** group and select **Invisible**.

### Soil

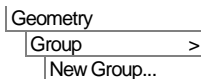

- With the features defining the wall invisible, select all the remaining features of the model that represent the soil by pressing the **Ctrl-A** keys.



Create a group containing the soil elements only and rename it **Soil**. Click **OK**.



## Drained Nonlinear Analysis of an Retaining Wall

---



- Drag and drop the material attribute **Nonlinear Soil** from the  Treeview onto the selection. With the **Assign to surfaces** option selected, click **OK** to assign the material attribute.
- In the  Treeview right-click on the **Wall** group and select **Visible**.

### Supports

Define supports to prescribe zero horizontal displacement as well as zero horizontal and vertical displacement.

- Click on the option to fix the **Translation in X**.
- Enter the attribute name as **Fixed in X** and click the **Apply** button to add the attribute to the  Treeview and keep the dialog active.
- Click on the option to fix the **Translation in Y**.
- Enter the attribute name as **Fixed in X and Y** and click the **OK** button to add the attribute to the  Treeview.

Assign the supports to the model.

- Select all the vertical Lines on the left-hand side and right-hand side of the model and drag and drop the support attribute **Fixed in X** from the  Treeview onto the selection. With the **Assign to lines** option selected, click **OK** to assign the support attribute to **All analysis loadcases**.
- Select the 3 horizontal Lines representing the bottom limit of the soil and drag and drop the support attribute **Fixed in X and Y** from the  Treeview onto the selection. With the **Assign to lines** option selected, click **OK** to assign the support attribute to **All analysis loadcases**.

Attributes  
Support...

- Select the Point which represents the top-left corner of the concrete wall as shown and drag and drop the support attribute **Fixed in X** from the  Treeview onto the selection.
- With the **Assign to Points** option selected, click **OK** to assign the support attribute to **All analysis loadcases**.

This support represents the prop to the top of the wall.

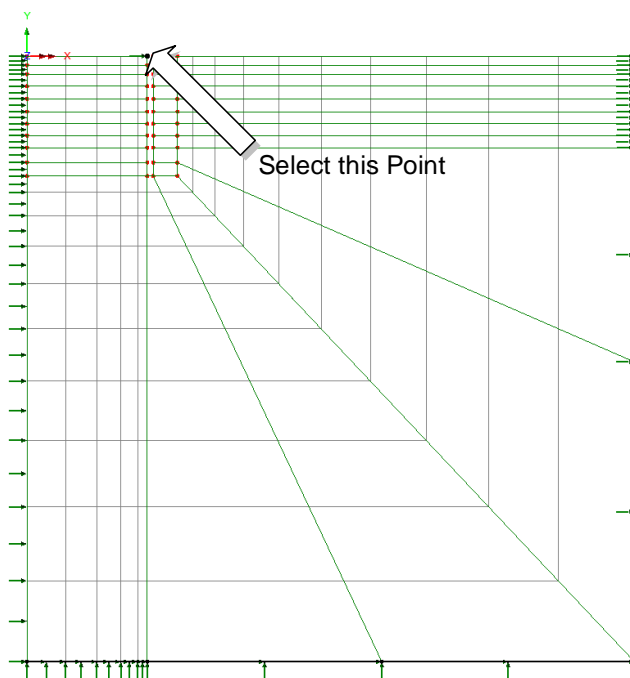

## Loading

The initial in situ ground conditions must be established in the first loadcase of the analysis. This is carried out using a gravity (body force) load.



Attributes

Loading...

- Select the **Body force** tab from the Structural Loading dialog and click **Next**
- Enter **-9.81** for the Linear acceleration in Y direction.
- Enter the attribute name as **Gravity** and click **Finish**.

### Assign the loads to the model.

Gravity is assigned to the whole model.

- With the whole model selected, drag and drop the loading attribute **Gravity** from the  Treeview onto the selection. With the **Assign to Surfaces** option selected, click **OK** to assign the loading attribute to **Loadcase 1**
- In the  Treeview drag and drop the **Geometry** layer name beneath the Attributes layer name.



**Note.** Gravity can also be assigned to a model as a property of an analysis or loadcase, but for this example the body force loading method is used.

### Modelling the removal of soil





The activation and deactivation facility must be used to simulate the removal of soil during the excavation in front of the wall. Excavation will take place over eight loadcases.

Attributes

Activate and  
Deactivate

- Select the **Deactivate** option and click **Next**. Select **Percentage to Redistribute** and ensure the value is set to **100%**. Enter the attribute name as **Excavation**.
- Click **Finish** to add the attribute to the  Treeview.

Assign the deactivation to the model.

-  Use the zoom-in button to enlarge the view of the top-left corner of the model.
-  If necessary, for clarity, turn -off the display of the loading by pressing the loading on/off button.
- Select the top surface representing the first layer of soil to be removed in front of the retaining wall and drag and drop the deactivation attribute **Excavation** from the  Treeview onto the selection. With the **Assign to surfaces** option selected, change the loadcase name to be **Excavation to -2m** and click **OK** to assign the attribute.
- Select the next surface down in front of the wall and drag and drop the deactivation attribute **Excavation** from the  Treeview onto the selection. With the **Assign to surfaces** option selected, change the loadcase name to be **Excavation to -4m** and click **OK** to assign the attribute.
- Repeat this procedure, selecting the next surface down each time and renaming the loadcases to be **Excavation to -6m**, **Excavation to -8m**, **Excavation to -10m**, **Excavation to -12m**, **Excavation to -14m** and **Excavation to -16m** respectively. The adjacent image shows the final excavation assignment made.

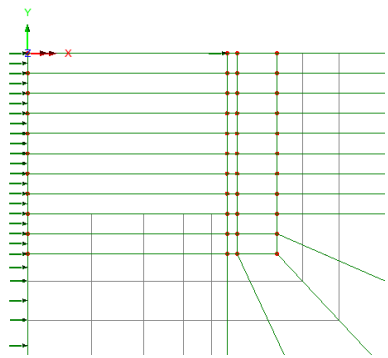
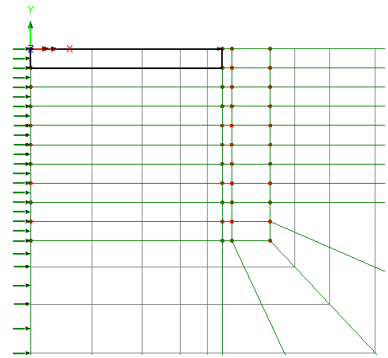



**Note.** Deactivated surfaces (and hence elements) can be visualised and checked by setting each loadcase active in the  Treeview.



## Analysis Control

The use of a Mohr-Coulomb nonlinear material in this example dictates that a nonlinear analysis control must be specified.

- In the  Treeview right-click on **Loadcase 1** and rename it to **In situ**
- In the  Treeview right-click on **In situ** and select **Nonlinear & Transient** from the **Controls** menu.
- In the Incrementation section, select the **Nonlinear** option and choose **Manual** incrementation. The default values will be used.
- Click **OK** to set the loadcase control.

## Saving the model

File  
Save



Save the model file.

## Running the Analysis



Open the **Solve Now** dialog. Press **OK** to run the analysis.

A LUSAS Datafile will be created from the model information. The LUSAS Solver uses this datafile to perform the analysis.

## If the analysis is successful...

Analysis loadcase results are added to the  Treeview

In addition, 2 files will be created in the Associated Model Data directory where the model file resides:



- drained\_wall.out** this output file contains details of model data, assigned attributes and selected statistics of the analysis.
- drained\_wall.mys** this is the LUSAS results file which is loaded automatically into the Treeview to allow results processing to take place.

## If the analysis fails...

If the analysis fails, the output file will provide information relating to the nature of the error encountered. A common mistake made when using LUSAS Modeller for the first time is to forget to assign particular attribute data (geometry, mesh, supports, loading etc.) to the model. Any errors listed in the output file should be fixed in LUSAS Modeller before saving the model and re-running the analysis.

### Rebuilding a Model

If errors are listed that for some reason cannot be corrected, a file is provided to re-create the model information correctly, allowing a subsequent analysis to be run successfully.



- drained\_wall\_modelling.vbs** carries out the modelling of the example.

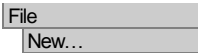

Start a new model file. If an existing model is open, Modeller will prompt for unsaved data to be saved before opening the new file.

- Enter the file name as **drained\_wall**

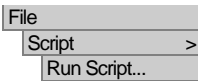

To recreate the model, select the file **drained\_wall\_modelling.vbs** located in the **\<LUSAS Installation Folder>\Examples\Modeller** directory.



Rerun the analysis to generate the results



**Note.** A warning message written to the text output window relating to  $K_0$  initialisation indicates that  $K_0$  conditions were not maintained during the soil initialisation step. This is usually a minor issue with irregular meshing or mixing of element types. In practice, the stresses should be reviewed to confirm they are acceptable.



## Viewing the Results

Loadcase results can be seen in the Treeview, and for a nonlinear analysis the load case results for the last solved loading increment are set active by default.

- If present, turn off the **Geometry**, **Mesh**, **Utilities** and **Attributes** in the Treeview.

### Wall Displacement

- In the Treeview ensure the right-click on the results for **Excavation to -14m** (the last but one loadcase) and **Set Active**.
- If not already on, add the **Deformed mesh** to add the deformed mesh layer to the Treeview.
- In the panel at the bottom of the Treeview press the **Deformations...** button, select the **Specify factor** option and specify a factor of **5**. Press **OK** to return.

- Double click the  **View properties** control object in the  Treeview. On the **View** tab ensure the option to **Show only activated elements** is selected. Click **OK** to visualise the deformed mesh for the active elements at increment 8 (Excavation to -14m), magnified by a factor of 5.

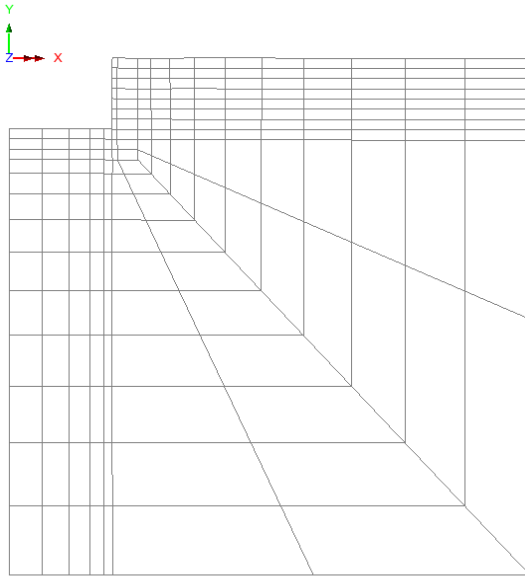

A graph of the deformation of the wall toe over a range of excavation loadcases will now be created using the graph wizard.

- Zoom into the top left-hand side of the model and select the node at the wall toe. See image right.
- With the **Time history** option selected click **Next**

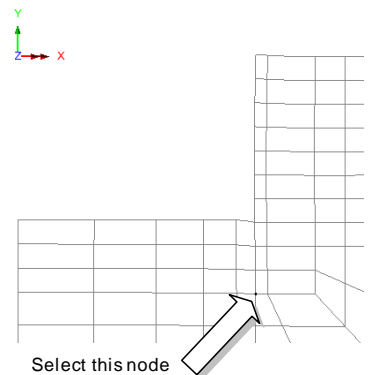

Utilities  
Graph Wizard...

Firstly define the data to be used for the X axis.

- Select the **Named** option and click **Next**
- Select **Loadcase ID** from the drop down list and click **Next**
- Secondly define the data for the Y axis.
- With the **Nodal** option selected and click **Next**

## Drained Nonlinear Analysis of an Retaining Wall

---

- Select **Displacement** from the Entity drop down list and **DX** from the Component drop down list.
- The selected node number will appear in the **Specify node** drop down list. Click **Next**
- Leave the title blank but enter suitable text for the graph axes and click **Finish** to display the graph of displacement of the wall toe towards the excavation.

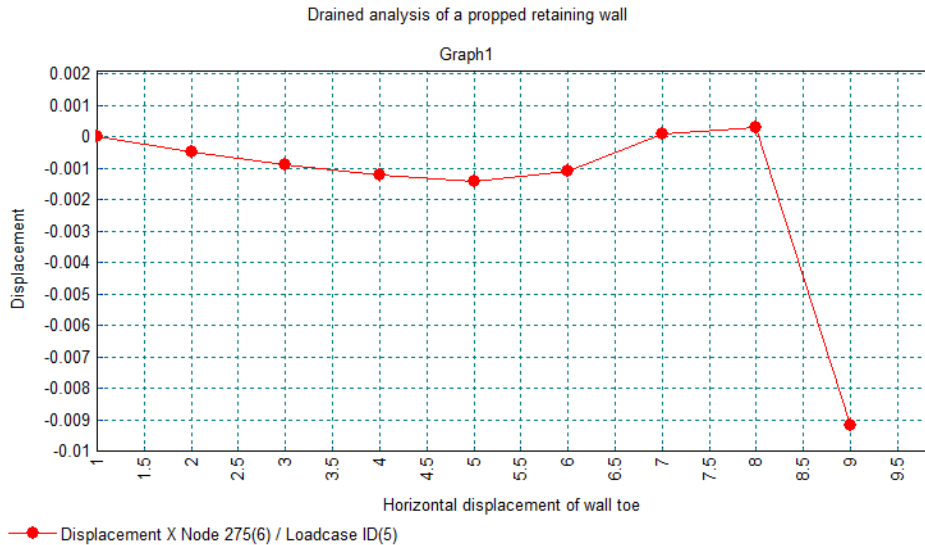

- Close the graph window.

## Surface Heave

- Select the node at the top of the back of the wall. See image right.
- With the **Time history** option selected click **Next**.

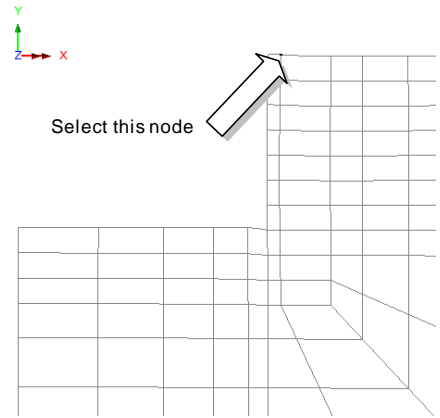

Firstly define the data to be used for the X axis.

- Selected the **Named** option and click **Next**.
- Select **Loadcase ID** from the drop down list and click **Next**.

Secondly define the data for the Y axis.

- With the **Nodal** option selected and click **Next**.
- Select **Displacement** from the Entity drop down list and **DY** from the Component drop down list.
- The selected node number will appear in the **Specify node** drop down list. Click **Next**.
- Enter suitable text for the graph titles and click **Finish** to display the graph of heave behind the wall.

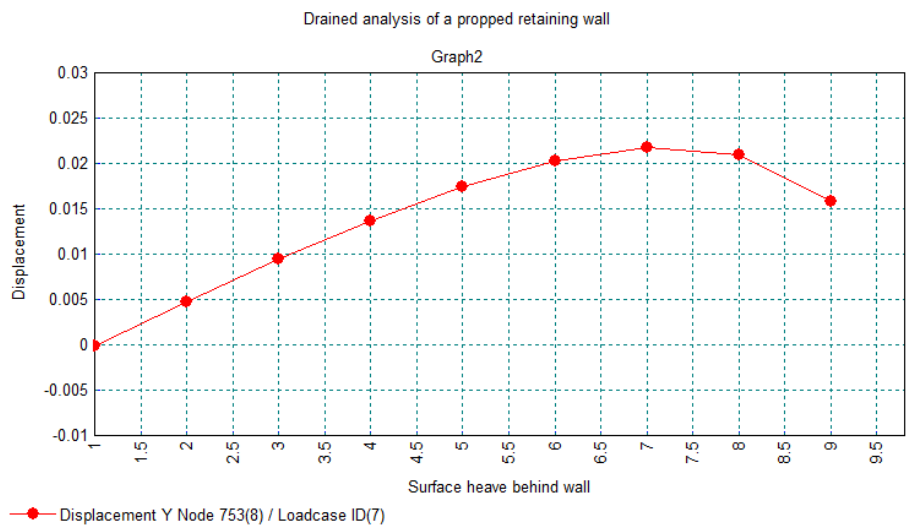



Utilities  
Graph wizard...

-  Close the graph window.



### Plotting contours of plastic strain in the soil

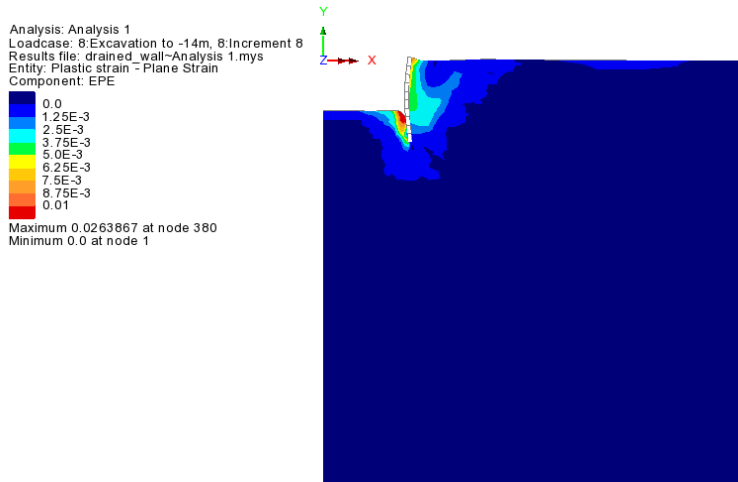

Because the model contains elements with two different material properties the active set on which results are to be plotted must be selected.

- In the  Treeview right-click on the group name **Soil** and select **Results Plots> Show Results Only On This Group**
- With no features selected click the right-hand mouse button in a blank part of the view window and select **Contours** to add the contours layer to the  Treeview.
- Select **Plastic strain** from the Entity drop down list and **EPE** from the component drop down list.
- Select the **Contour Range** tab and set the **Maximum** to **0.01** (1% strain).
- Click the **OK** button to display contours of the plastic strain distribution around the wall.



### Wall Prop Force

- Turn off the display of the **Deformed Mesh** and **Contours** layers in the  Treeview.
- Turn on the display of the **Mesh** layer in the  Treeview.

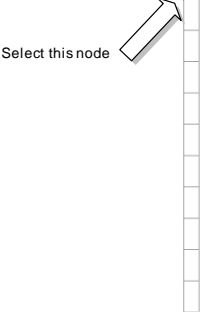
- In the  Treeview right-click on the group name **Wall** and select **Results Plots> Show Results Only On This Group**
- Right-click on the group **Wall** in the  Treeview and select **Set as Only Visible**.
- **Select the node** at the top-left of the wall that is supported by the prop in the X direction. 
- With the **Time history** option selected click **Next**. 

Utilities  
Graph Wizard...

Firstly define the data to be used for the X axis.

- Selected the **Named** option and click **Next**.
- Select **Loadcase ID** from the drop down list and click **Next**.

Secondly define the data for the Y axis.

- With the **Nodal** option selected and click **Next**.
- Select **Reaction** from the Entity drop down list and **RSLT** from the Component drop down list.
- The selected node number will appear in the **Specify node** drop down list. Click **Next**.
- Enter suitable text for the graph titles and click **Finish** to display the graph of heave behind the wall.

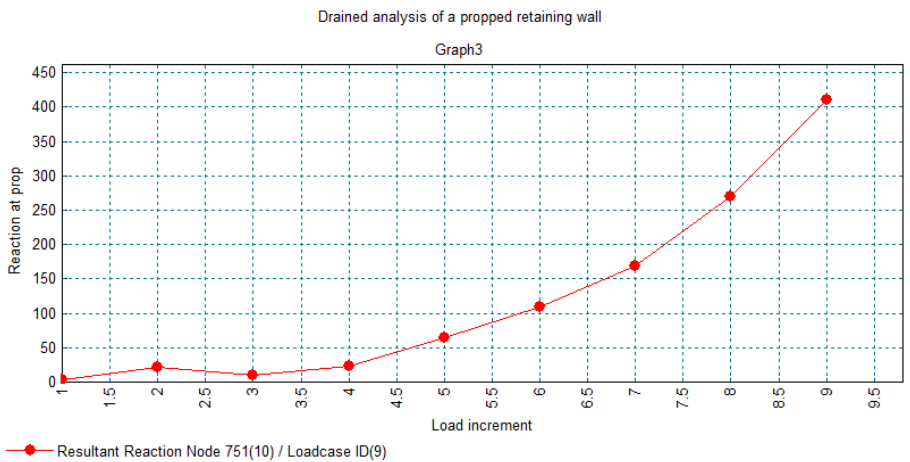



**Note.** The resultant reaction has been graphed in the above figure. Since the wall is propped only in the horizontal (X) direction at this location (see Supports section) there is no reaction in the vertical direction and therefore the resultant reaction is identical to the horizontal reaction.

-  Close the graph window.

### Bending moment in the wall at 10m Depth

Because the model contains elements with two different material properties the active set on which results are to be plotted must be chosen.

- Turn off the **Deformed mesh** layer in the  Treeview, and restore the **Geometry** layer by right-hand clicking on a blank area of the model view and selecting **Geometry**.
- Ensure the **Snap to grid** option is selected and enter a value of **1** for **Grid size**.
- Click on **OK**.
- With reference to the ruler on the edge of the view window, draw a line with the mouse through the wall at 10m depth as shown.

Utilities  
Graph Through 2D...

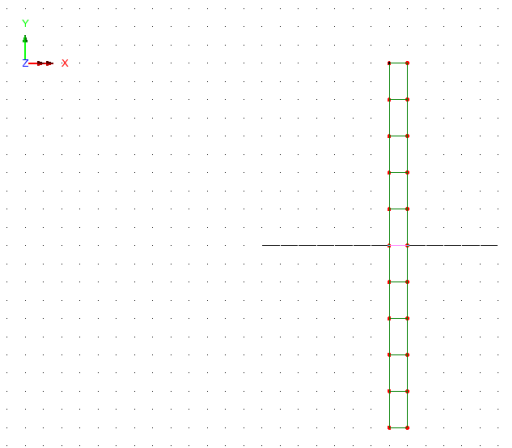

- Ensure the **Active** loadcase radio button is selected, and press **Next**:
- Select **Resultant effects from 2D model** and ensure that only the **Bending stress** option is selected in the list and click **Next**.



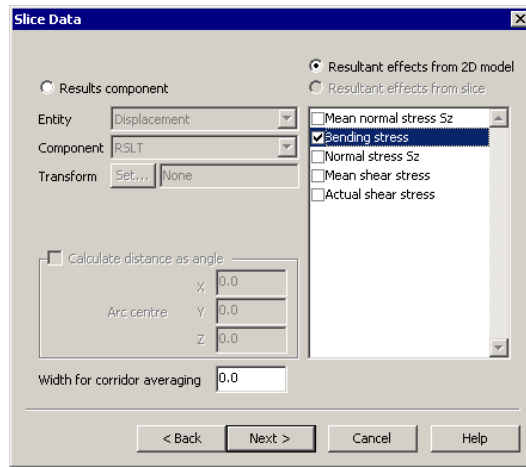

- Enter suitable text for the graph titles and click **Finish**.

A graph is drawn and the bending moment (and other information) is displayed in the Text output pane.

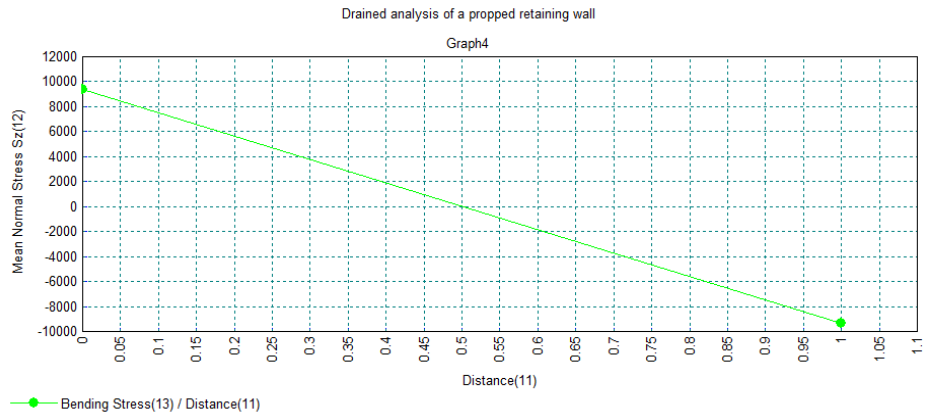

```

Text Output
Dataset 21 , no. of values 2 range -66.035 to -66.035 (mean shear)
Dataset 22 , no. of values 2 range -84.0286 to -48.0414 (actual shear)
2D Forces/moments
Loadcase "8:Increment 8"
Results File "drained_wall~Analysis 1.mys" (ID=1)
Axial force per unit width = -492.244
Shear force per unit width = -66.035
Moment per unit width = 1.55993E3
Section Depth 1.0
Mean normal stress Sz = -492.244
Nominal bending stress = 9.35957E3

```

The bending moment reported is 1560 kN/m<sup>2</sup> per metre run of the wall.

This completes the example.