

Linear Elastic Analysis of a Spanner

For LUSAS version:	19.0
For software product(s):	All (except LT versions)
With product option(s):	None.

Description

A linear static analysis is to be carried out on the spanner shown.

The spanner is supported as though it were being used to turn a nut, and is loaded with a constant pressure load along the top edge of the handle.

Units used are N, mm, t, s, C, throughout.

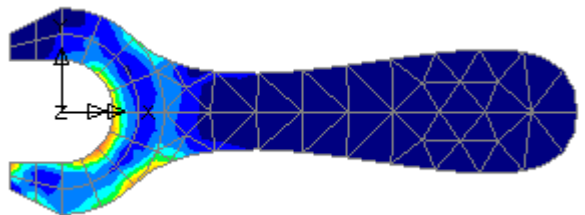

Keywords

2D, Inplane, Plane stress, Linear, Elastic, Regular Meshing, Irregular Meshing, Copy, Rotate, Mirror, Transformation, Groups, Deformed Shape, Contour Plot, Principal Stress Vector Plot, Graph Plotting, Slice Section Results.

Objectives

The required output from the analysis is:

- A plot of the deformed shape.
- A plot of the equivalent stresses in the spanner.
- A graph showing the variation in equivalent stress where the handle meets the jaws.

Associated Files



- spanner_modelling.vbs** carries out the modelling of the example.

Modelling : Features

This section covers the definition of the features (Points, Lines and Surfaces) which together form the geometry of the spanner.

- The symmetry of the spanner will be used by firstly defining one half and then mirroring about a horizontal centre-line.
- One half of the jaws will be defined by three Surfaces using 3 different methods. One Surface will be defined simply by its bounding coordinates, a second by sweeping a Line through a rotational transformation and a third by copying the second Surface using a pre-defined rotation.
- One half of the handle will be defined using one Surface. It will be bounded by three Lines, one of which will be a cubic spline.
- Once the Surfaces have been defined, they will all be mirrored about the spanner centre-line.
- The features which make up the spanner will be divided into two Groups, the jaws and the handle, to make the assignment of attributes easier.

Running LUSAS Modeller

For details of how to run LUSAS Modeller see the heading *Running LUSAS Modeller* in the *Introduction to LUSAS Worked Examples* document.



Note. This example is written assuming a new LUSAS Modeller session has been started. If continuing from an existing Modeller session select the menu command **File>New** to start a new model file. Modeller will prompt for any unsaved data and display the New Model dialog.

Creating a new model

- Enter a File name of **Spanner**
- Use the default User-defined working folder.
- Ensure an Analysis type of **Structural** is set.
- Select an Analysis Category of **2D Inplane**
- Set Model units of **N,mm,t,s,C**
- Leave the Timescale units as **Seconds**
- Select a Startup template of **2D Plane Stress**.
- Ensure the Layout grid is set as **None**
- Enter a Title of **spanner**
- Click the **OK** button.

The Attributes  treeview will be populated with potentially useful basic line mesh, geometric and support entries appropriate to the settings made on the new model dialog.



Note. The Undo button  may be used to correct a mistake. The undo button allows any number of actions since the last save to be undone.

Modelling geometry

LUSAS Modeller is a feature-based modelling system. The model geometry is defined in terms of features (Points, Lines, Surfaces and Volumes) which are later meshed to generate the Finite Element Model ready for solution. The features form a hierarchy, with Points defining Lines, Lines defining Surfaces and Surfaces defining Volumes.

Linear Elastic Analysis of a Spanner

Geometry
Surface >
By Coords...



Enter coordinates of $(0, 20)$, $(-20, 20)$, $(-20, 30)$ and $(0, 40)$ to define the vertices of the Surface.



Note. Sets of coordinates are separated by commas or spaces. The **Tab** key is used to create new entry fields. The arrow keys are used to move between entries.

- Click the **OK** button to make the dialog disappear and generate the Surface as shown.



Note. If the Z ordinate is omitted zero is assumed.



Note. Confirmation that the Surface has been created is given in the message window.



Note. Cartesian, cylindrical or spherical coordinates systems may be used to define models. In this example Cartesian coordinates will be used throughout.

The right-hand vertical Line will be used to create a Surface by sweeping the line through a rotation of 45 degrees clockwise.

- Select the Line by moving the cursor over the Line shown and clicking the left-hand mouse button.

The line will change colour to show it has been selected.



Note. Feedback on the items currently selected is provided on the right-hand side of the status bar at the bottom of the display.

	(X, Y, Z)
1	0,20
2	-20,20
3	-20,30
4	0,40

Select this Line

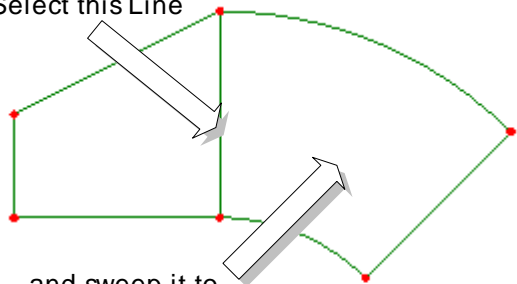

... and sweep it to form this Surface



Geometry
 Surface >
 By Sweeping..



Select the **Rotate** option and enter **-45** for the angle of rotation about the **Z-axis**.

- Enter the attribute name as **Rotate 45 Clockwise**
- Click the **Save** button to save the dataset for re-use later.
- Click the **OK** button to sweep the Line clockwise through 45 degrees about (0,0,0) to create a Surface.



Note. Clockwise angles are negative and anti-clockwise angles are positive.

The Surface just drawn will now be copied by rotating it through a 45 degree rotation clockwise.

- Select the previously drawn Surface by clicking on it with the left-hand mouse button.

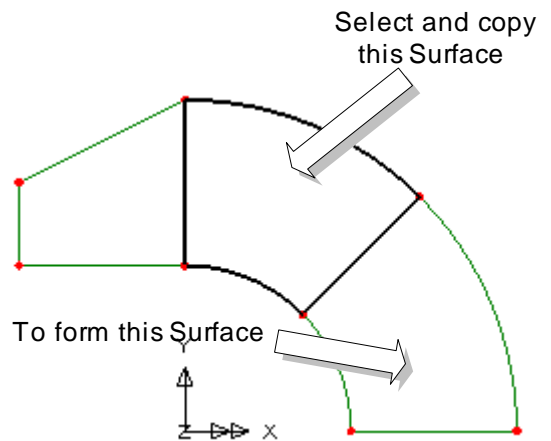
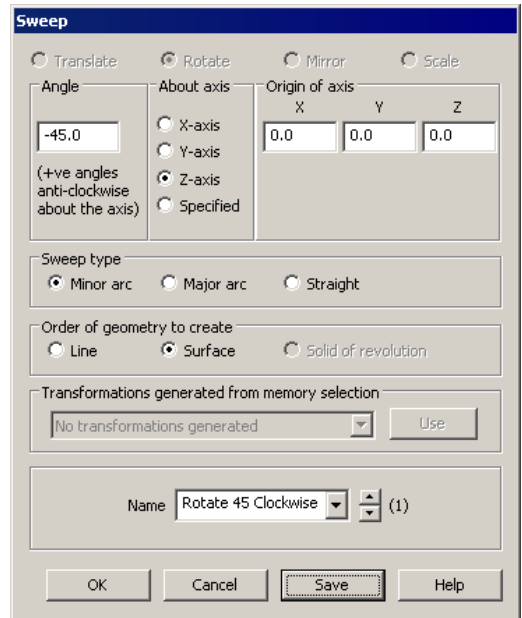

Linear Elastic Analysis of a Spanner

Geometry
Surface >
Copy...



Select the attribute **Rotate 45 Clockwise** from the drop down list.

- Ensure that the number of copies is set to **1**
- Click the **OK** button to copy the Surface, rotating it clockwise through 45 degrees.

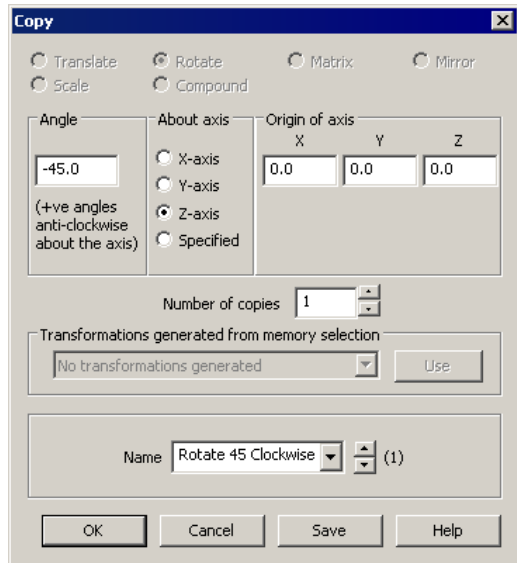

To define the top line of the handle of the spanner a cubic spline will be created.



Note. A cubic spline is a Line which passes through any number of Points. If required, the start and finish directions of the spline can be defined by specifying end-tangents (i.e. by specifying the directions of Lines at its ends).

In this example end-tangents are used to fix the start and finish directions of the spline so a construction Line must first be defined.

Geometry
Line >
By Coords...



Enter coordinates of **(200, 0)** and **(200, -10)** to define the construction Line.

- Click the **OK** button to generate a vertical Line away from the existing Surfaces.

This Line will be used to specify the finishing direction of the cubic spline.



Note. When selecting features to define a cubic spline it is very important that the correct features are selected in a particular order. The Lines that define the start and finish directions of the spline are to be selected first, followed by the Points that define the start and end positions of the spline.

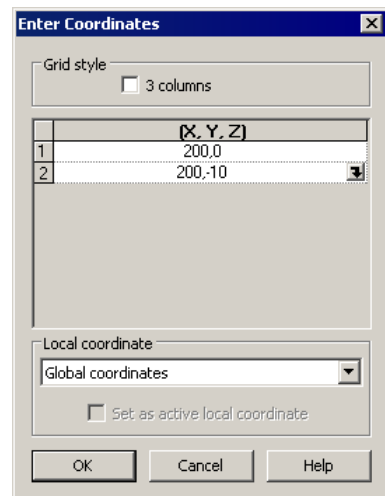

Defining a cubic spline

- Select the arc shown by moving the mouse over the arc and click the left-hand mouse button. (This arc defines the direction in which the spline starts).
- Hold the **Shift** key down to add additional features to the selection
- Select the construction Line defined earlier by moving the mouse over the Line shown and click the left-hand mouse button. (This Line defines the direction in which the spline ends).
- Continue holding the **Shift** key down to further add to the selection. Select the Point on the end of the first arc selected. (This defines where the spline starts).
- Still holding the **Shift** key down, select the Point on the end of the construction Line. (This defines where the spline ends).
- Click the **OK** button to generate a default cubic spline to form the handle of the spanner, ensuring that both reverse options are off.

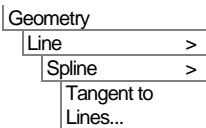
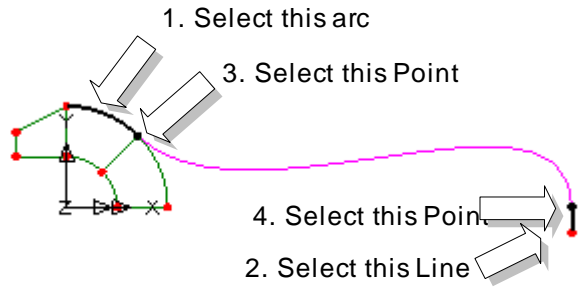

Note. Line directions can be seen by double-clicking on the Geometry entry in the Treeview and selecting the Line directions check box.

Once the spline is drawn correctly the construction Line is deleted.

- Drag a box around the construction Line by firstly moving the mouse above and to the left of the Line.

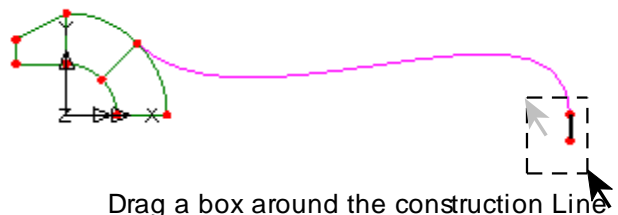

- Click the left-hand mouse button and holding it down move the mouse to the right and down so that a box is shown which completely encloses the Line as shown. Release the left-hand mouse button. LUSAS will highlight the selected features.

Linear Elastic Analysis of a Spanner

Edit
Delete

 Delete the selected features.

- Click the **Yes To All** button to delete the selected Line and Points



Note. The **Delete** key can also be used to delete features. For a full list of keyboard shortcuts refer to the Online Help file, which can be accessed from the **Help > Help Topics** menu.

The centre-line of the spanner can now be defined by joining the two unconnected points into a Line.

- Drag a box around the two Points on the centre-line of the spanner as shown

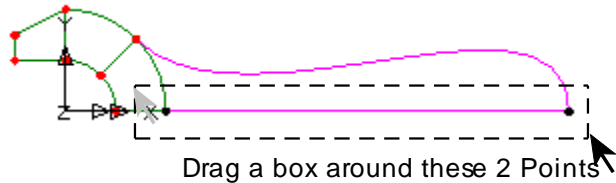

Geometry
Line >
By Points...

 A Line will be drawn between the points selected.

The Surface forming the handle of the spanner will now be defined by selecting the three Lines bounding the Surface.

- Select the 3 Lines which define the Surface of the handle in the order shown, ensuring the **Shift** key is held down to keep adding to the selection.

1. Select this Line

2. Hold Shift key down



3. With Shift key down select this Line

4. With Shift key down select this Line

Geometry
Surface >
Lines...

 If prompted, press **OK** to draw the Surface formed by the 3 lines selected.

Note. Selecting the Lines in this anti-clockwise order ensures that the local element axes of the Surface will be suitable for the applied face loading that will be applied later in the example. Selecting the Lines by dragging a box around them would not necessarily produce the same Surface axes.

Mirroring model information

Half of the model has now been defined. This half can now be mirrored to create the whole model. The first step in the process is to define a mirror plane.

- Select the 2 points shown, making sure the **Shift** key is held down in order to add the second Point to the initial selection.

These Points define the axis about which the spanner will be mirrored.

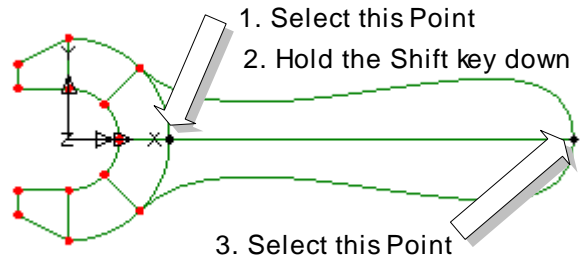

Places the Points selected into memory.

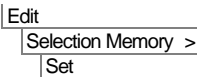

Next, the Surfaces to be mirrored are to be selected. This will require the whole model to be selected.

- Select the whole model by dragging a box around the features



Note. An alternative to dragging a box around all the features to select them is to press the **Ctrl** and **A** keys at the same time.

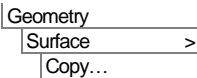

Select **Mirror – from Point 14 and Point 15** from the drop down list and click the **Use** button on the dialog to use the points previously stored in memory.

- Click the **OK** button to copy all of the Surfaces, mirroring them about the centre-line to give the model shown in the previous diagram.

If the model features have been mirrored successfully the Points held in memory may be cleared.

The Points are now cleared from memory.

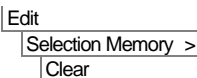

Note. Right-clicking on the view with geometry selected opens a menu with shortcuts to **Delete**, **Move**, **Copy** and **Sweep**.

This has completed the spanner geometry.

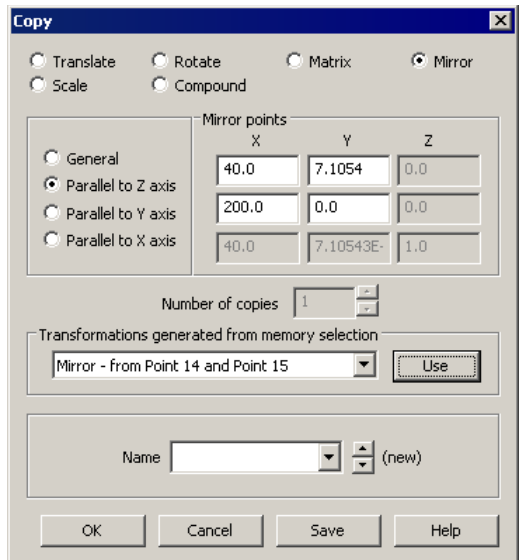

Using Groups





Tip. Model features can be grouped together to make assignment and viewing of model attributes easier.

In this example the Surfaces defining the jaws of the spanner will form one Group. The Surfaces defining the handle of the spanner will form another Group.

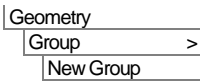
- Drag a box around the Surfaces representing the jaws of the spanner.



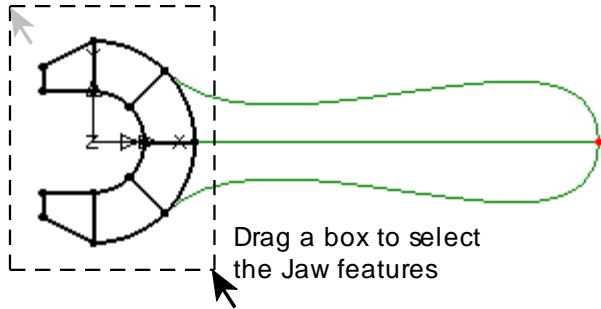

 This adds a New Group entry to the  Treeview for the features selected.

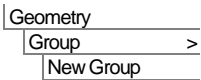

- Enter the group name as **Jaws** and click **OK** to finish defining the group.

- Drag a box around the Surfaces representing the handle of the spanner.



 This adds a New Group entry to the  Treeview for the features selected.

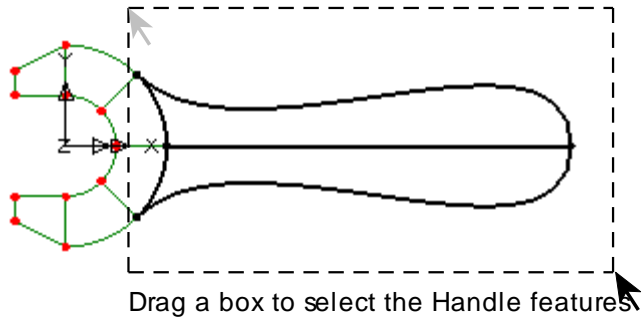

- Enter the group name as **Handle** and click **OK** to finish defining the group.

Modelling features recap

The features that form the 2-Dimensional representation of the spanner have been defined. In this section the following topics have been covered:

- How to define Points, Lines and Surfaces.
- How to define Lines by specifying the coordinates of their Points and by joining existing Points.
- How to define Surfaces by their bounding coordinates, by sweeping, and by copying.
- How to define a cubic spline.
- How to select features by using the Shift Key to add to a previous selection.
- How to select features by dragging a box around features to be selected.
- How to select all features in a model by pressing the Control and A keys.
- How to rotate and mirror model features.
- How to define groups of features.

Modelling : Attributes

The Attributes  treeview will be initially populated with useful basic line mesh, geometric and support entries appropriate to the settings made on the new model dialog. Where applicable these can be assigned directly to selected features in a model, or be edited as required. Otherwise, specific attributes will need to be defined.



For this example the following attributes need to be defined:

- The finite element **mesh** to be used.
- The **thickness** of the spanner.
- The **material** from which the spanner is made.
- The **supports** to be used.
- The **loading** on the spanner.

Defining and assigning model attributes



Note. LUSAS Modeller works on a define and assign basis where attributes are first defined, then assigned to features of the model. This can be done either in a step-by-step fashion for each attribute or by defining all attributes first and then assigning all, in turn, to the model.

- ❑ Attributes are first defined and are subsequently displayed in the  Treeview as shown. Unassigned attributes appear 'greyed-out'. Assigned attributes appear 'coloured'.
- ❑ Attributes are then assigned to features by dragging an attribute dataset from the  Treeview onto previously selected features.



Tip. Useful commands relating to the manipulation of attributes can be accessed by selecting an attribute in the  Treeview, then clicking the right-hand mouse button to display a shortcut menu.

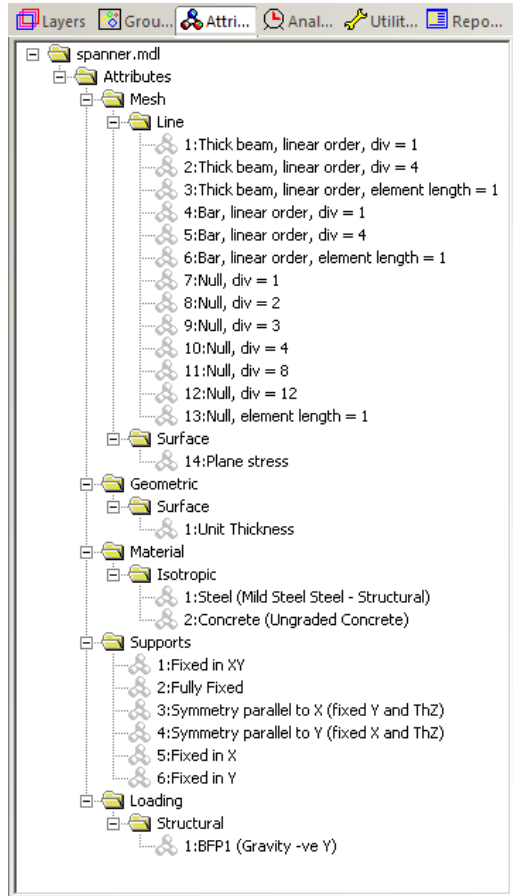

Defining the mesh

The spanner will be meshed using both regular and irregular Surface meshes. A regular mesh is to be used for the jaws of the spanner. An irregular mesh will be used for the handle.

The number of elements in the regular Surface mesh will be controlled by defining line meshes on the Lines defining the boundary of the Surfaces. The number of elements in the irregular Surface mesh will be controlled by specifying an ideal element size. Other methods of controlling mesh density are also available.

Defining a regular surface mesh

Attributes
 Mesh >
 Surface...

- Select **Plane stress** elements, which are **Quadrilateral** in shape with a **Quadratic** interpolation order.
- Ensure that the **Regular Mesh** button is selected and **Allow transition pattern** is not selected.
- Enter the attribute name as **Regular Plane Stress**
- Click the **OK** button to add the Surface mesh dataset to the  Treeview.

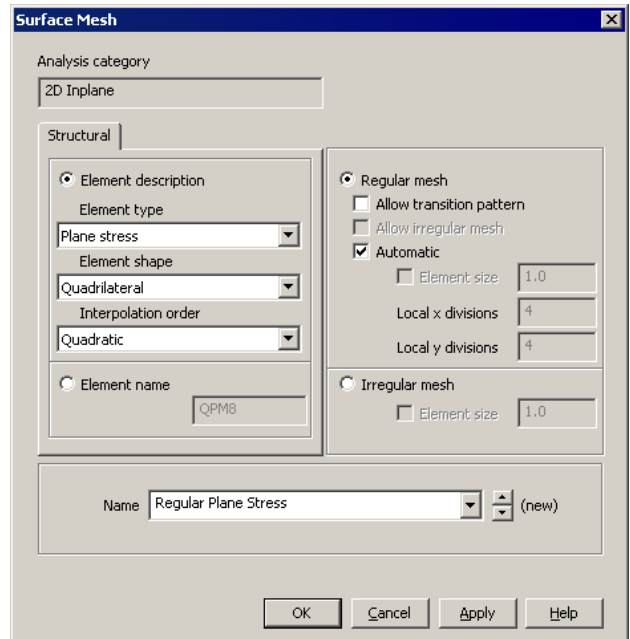

The mesh will be assigned to the model at a later stage.

Controlling mesh density

The lines currently defined have 4 divisions per line by default, but in this example only 2 divisions are required for the Lines defining the jaws. This can be done by either changing the default number of divisions per Line or by making use of Line mesh attributes. In this example, the default number of divisions will be changed.

File
 Model Properties...

- Select the **Meshing** tab and set the **Default Line divisions** to **2**.
- Click the **OK** button.

Defining an irregular surface mesh

Attributes
 Mesh >
 Surface...

- Select **Plane stress, Triangle, Quadratic** elements.
- Select the **Irregular mesh** button.
- Select **Element Size** and then specify an element size of **18**. (This defines the maximum side length of the elements on the lines defining the perimeter of the spanner.)
- Enter the attribute name as **Irregular Plane Stress**.

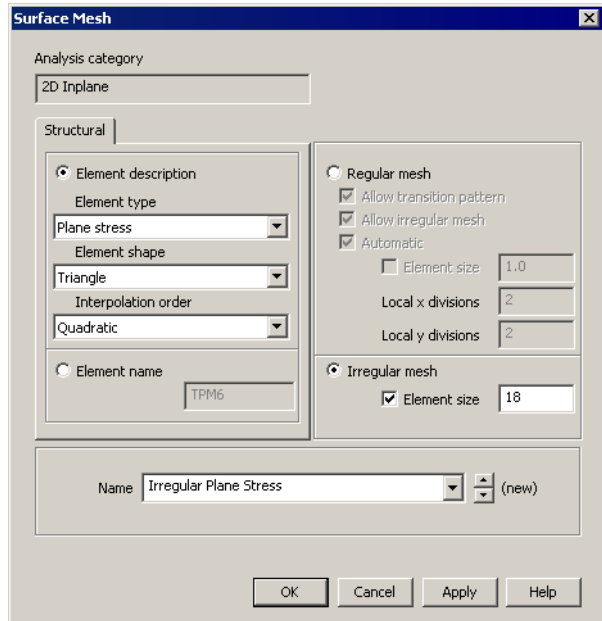

- Click the OK button to add the Surface mesh attribute to the Treeview.

The mesh will be assigned to the model at a later stage.

Defining the thickness

So far the spanner has been defined in two dimensions. In order to give the spanner its thickness geometry attributes will be used. The jaws of the spanner are 15mm thick whilst the handle is 10mm thick. Two geometry attributes are required.

Attributes
 Geometric >
 Surface...

- Enter the thickness as **15**.
- Enter the Attribute name as **Thickness=15**
- Click the **Apply** button to add the geometry attribute to the Treeview.

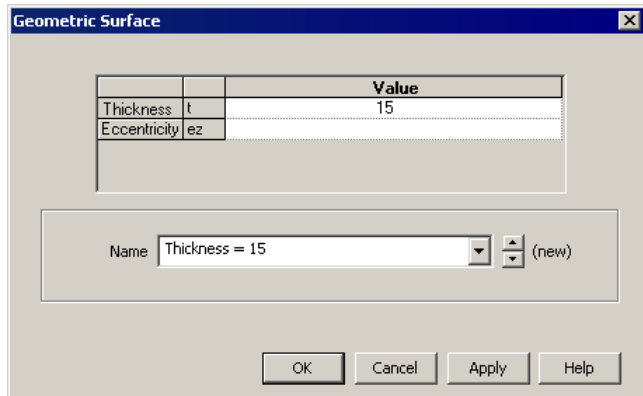





Note. The Apply button allows information for another attribute to be entered using the same dialog.

- Change the thickness to **10**
- Change the attribute name to **Thickness=10** and click the **OK** button to add the additional geometry attribute to the  Treeview.

Assigning a surface mesh and thickness to the jaws

The Surface mesh and geometry attributes defined previously can now be assigned to the relevant features of the spanner. As an alternative to selecting features by dragging a box around them, the previously named Groups can be used.

- In the  Treeview, click the right-hand mouse button on the group name **Jaws** and select the **Select Members** option from the menu. If you already have some features selected click **Yes** to deselect them first.
- Drag and drop the Surface mesh attribute **Regular Plane Stress** from the  Treeview onto the selected Surfaces. Modeller will confirm the mesh assignment for each Surface in the text window.

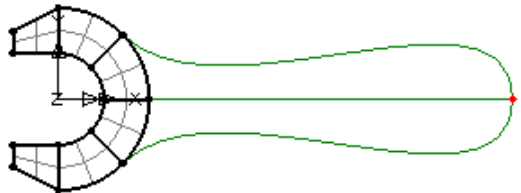

The element mesh for the jaws of the spanner will be drawn.

- Drag and drop the Surface geometry attribute **Thickness=15** from the  Treeview onto the selected Surfaces. The elements of the jaws remain selected.
- Click the left-hand mouse button in a blank part of the View Window to deselect any previously selected model features. This shows that the geometric assignment has been visualised by default.

Assigning surface mesh and thickness to the handle

- In the  Treeview, click the right-hand mouse button on the Group name **Handle** and select the **Select Members** option from the menu.

All Surfaces forming the group **Handle** will be selected.

Linear Elastic Analysis of a Spanner

- Drag and drop the Surface mesh attribute **Irregular Plane Stress** from the  Treeview onto the selected Surfaces defining the Handle.

LUSAS will draw the irregular element mesh for the handle of the spanner.



Note. The text output window will show messages relating to the radius of curvature for two of the elements created. These can be ignored for this example.

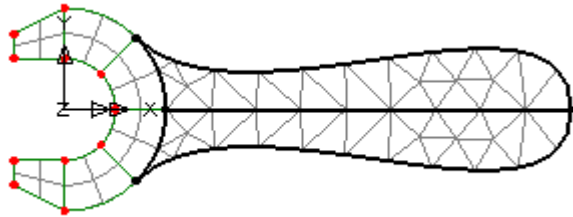

- Drag and drop the Surface geometry attribute **Thickness=10** from the  Treeview onto the selected Surfaces. Again confirmation of the assignment is provided in the text window.
- Click the left-hand mouse button in a blank part of the View Window to deselect any previously selected model features.

Assigning the material

The material required for this example is provided by default when using the startup templates specified when creating the model.

- Right-hand click the material attribute **Steel (Mild Steel | Steel - Structural)** from the  Treeview and select **Assign to all** to apply the mild steel attribute to the whole model.

Visualising model attributes



Note. Any attributes (i.e. geometry, material, supports etc.) assigned to the model can be checked visually to ensure that the correct item has been assigned to the correct part of the model. For example:

- Click the left-hand mouse button in a blank part of the View Window to deselect any previously selected model features.
- In the  Treeview, click the right-hand mouse button on the **Thickness=15** material attribute name and select the **Visualise Assignments** option from the dialog.

All features to which the **Thickness=15** attribute is assigned will be visualised.

- To turn-off the visualisation of the assignments, click the right-hand mouse button on the

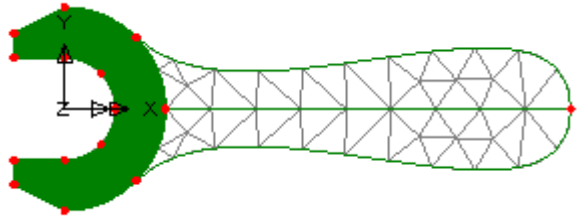

Thickness=15 material attribute name in the  Treeview and select the **Visualise Assignments** option again from the dialog.



Note. This method can be used at any time during this example to check that selected attributes have been correctly assigned to the model.

Manipulating layers

At any time the layers displayed in the  Treeview may be re-ordered, hidden, removed or be re-added.

- Select the **Mesh** entry in the  Treeview and drag it down to sit beneath the **Geometry** entry. In the view window the mesh can now be seen drawn on top of the geometry.
- Click the right-hand mouse button on the **Mesh** entry in the  Treeview and select the **On/Off** option. The mesh will be hidden from the display.

Fleshing

Visualisation of assigned geometric attributes can also be seen using the fleshing option.



Select the fleshing on/off button to turn-on geometric property visualisation.



Select the isometric button to see the geometric visualisation on the elements.



Select the dynamic rotate button to view the spanner from the side. The

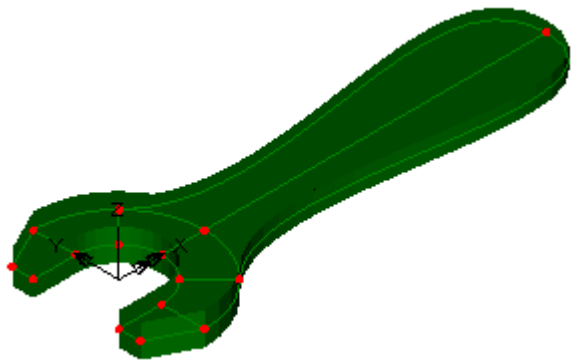

difference in thickness between the handle and the jaws can be seen.



Select the fleshing on/off button to turn-off the geometric visualisation.



Select the Home button to return the model to the default view.



Reset to normal cursor mode.

Supports

When using one of the standard startup templates, LUSAS provides the more common types of support by default. These can be seen in the  Treeview. Two support attributes are required, one which restrains movement in the X direction, and one which restrains movement in the Y direction.

Assigning the supports

- Select the Point on the centreline of the spanner as shown to assign the support **Fixed in X**.
- Drag and drop the support attribute **Fixed in X** from the  Treeview onto the selected point.
- Click the **OK** button to assign the support to the Point selected for all the loadcases in analysis 1.

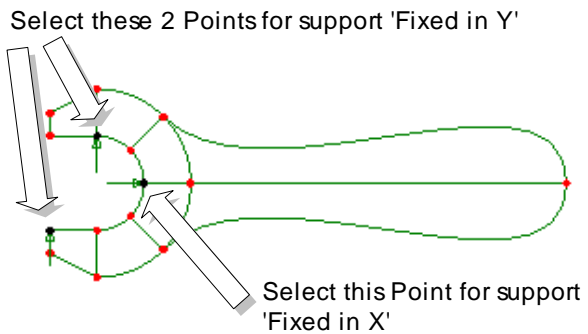

The support will be visualised using an arrow symbol.

- Select the 2 Points shown to assign the support **Fixed in Y**. Hold the **Shift** key down to add the second point to the initial selection.
- Drag and drop the support attribute **Fixed in Y** onto the selected points.
- Click the **OK** button to assign the support to the points selected.
- The supports will be visualised using arrow symbols.
- Click the left-hand mouse button in a blank part of the view window to deselect any previously selected model features.

Defining the loading

A pressure load is to be distributed evenly along the top edge of the handle.

Attributes
Loading... >

- Select the **Face** option and click **Next**

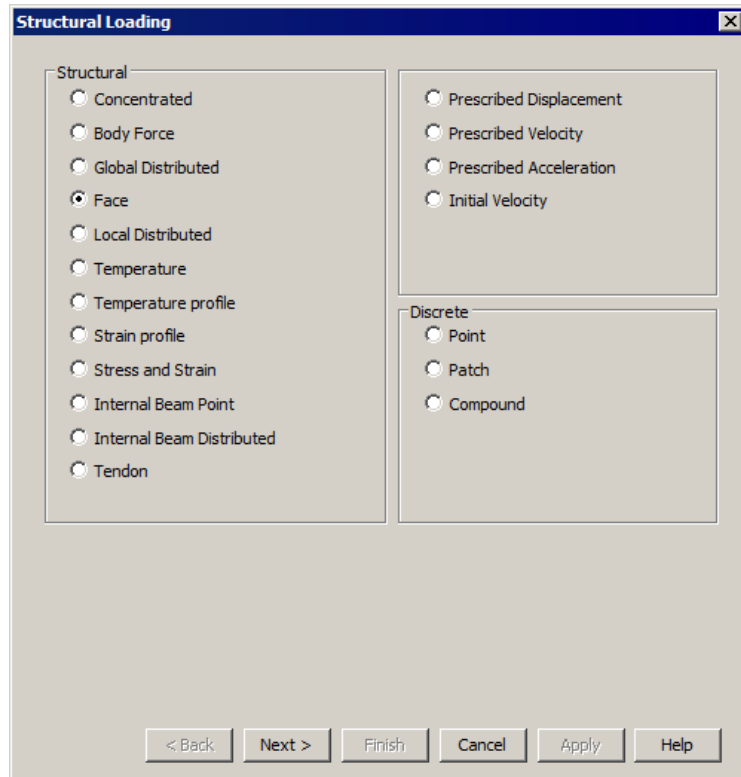

- On the Face loading dialog enter a load of **0.1** in the **y** direction.
- Enter the attribute name as **Face Load of 0.1**.
- Click the **Finish** button to add the loading attribute to the  Treeview.

Assigning the loading

- Select the Line on the top edge of the spanner handle.
- Drag and drop the loading attribute **Face Load of 0.1** from the  Treeview onto the selected Line.
- Click the **OK** button to assign the loading to the Line selected.

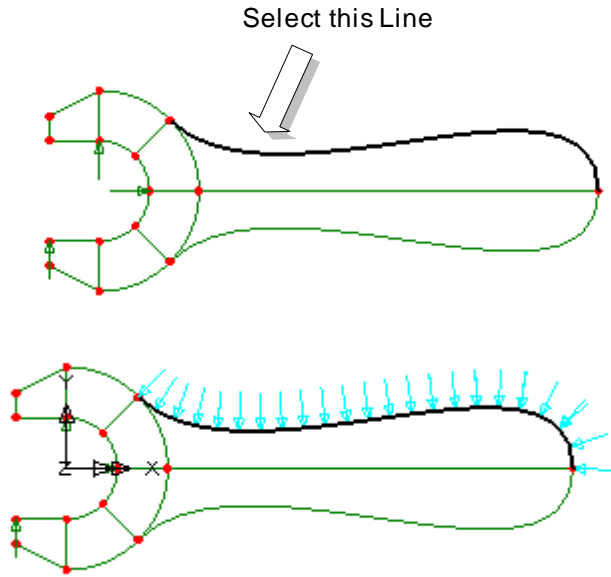

Note. If the loading is displayed in the opposite direction to that shown the Surface forming the top half of the handle may be reversed as follows:

- Select the Surface defining the top-half of the spanner by dragging a box around it.

This will reverse the Surface axes and hence the direction of the loading.

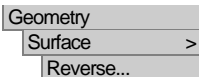

Saving the model



To save the model file.



Modelling attributes recap

In this section, the attributes of the model were defined and assigned to the features.

- A regular Surface mesh with quadrilateral plane stress elements was defined and assigned to the jaws of the spanner. An irregular Surface mesh with triangular

plane stress elements and a fixed element size was defined and assigned to the handle of the spanner.

- Two geometry attributes were used to specify the spanner jaws and handle thickness.
- A material attribute specifying the properties of steel was assigned to all Surfaces.
- Two support attributes were assigned in order to simulate the spanner being used to turn a nut and a structural face load was applied to the top edge of the handle.
- Attributes assigned to the model were checked visually for correct assignment.

The model definition is now complete. The next step in the process is to run an analysis to solve the problem.

Running the Analysis



Open the **Solve Now** dialog and press **OK** to run the analysis.

If the analysis is successful...

Analysis loadcase results are added to the Treeview.

In addition, 2 files will be created in the Associated Model Data directory where the model file resides:



- spanner.out** this output file contains details of model data, assigned attributes and selected statistics of the analysis.
- spanner.mys** this is the LUSAS results file which is loaded automatically into the Treeview to allow results processing to take place.

If the analysis fails...

If the analysis fails, information relating to the nature of the error encountered can be written to an output file in addition to the text output window. Any errors listed in the text output window should be corrected in LUSAS Modeller before saving the model and re-running the analysis. Note that a common mistake made when using LUSAS Modeller for the first time is to forget to assign particular attribute data (geometry, mesh, supports, loading etc.) to the model.

Rebuilding a Model

If errors are listed that for some reason cannot be corrected, a file is provided to re-create the model information correctly, allowing a subsequent analysis to be run successfully.



- spanner_modelling.vbs** carries out the modelling of the example.



Start a new model file. If an existing model is open, Modeller will prompt for unsaved data to be saved before opening the new file.

- Enter the file name as **spanner**

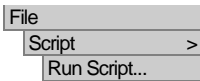

To recreate the model, select the file **spanner_modelling.vbs** located in the \<LUSAS Installation Folder>\Examples\Modeller directory.





Solve the model to generate the results.

Viewing the Results

In this section the results produced by the analysis of the spanner will be viewed. There are a number of ways to do this in LUSAS, allowing you to choose the most appropriate way to present your results. For this example:

- A plot of the deformed mesh will be displayed and superimposed upon the undeformed shape for comparison.
- The principal stress vectors will be plotted.
- The von Mises stress contours for averaged stress values will be displayed.
- Peak values of von Mises stress will be marked.
- A graph will be produced showing the variation of stress along a slice section through the handle of the spanner.

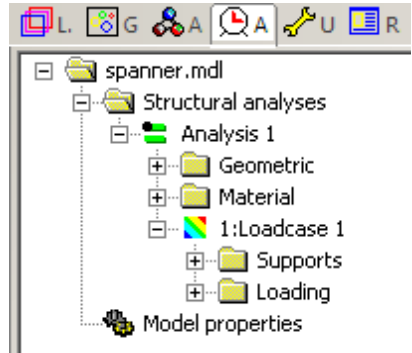

Selecting the results to be viewed

Analysis loadcase results are present in the  Treeview inside the Analysis 1 entry as signified by the results bitmap .



Deformed mesh plot

To plot a deformed mesh the Geometry and Attribute layers will be hidden, the Mesh layer will be turned on, and the Deformed mesh layer will be added to the  Treeview.

- Click the right-hand mouse button on the **Geometry** entry in the  Treeview and select the **On/Off** option. The geometry will be hidden from the display.
- Repeat to turn off the display of the **Attributes** layer.
- Repeat to turn on the **Mesh** layer.
- Double click on the **Mesh** layer in the  Treeview to display the mesh layer properties.

The mesh layer is to be plotted in green.

- Select  and a dialog will appear showing the range of pens and colours in use.

The mesh is currently drawn in a solid grey line style and is shown by the button with dashed outline.



- Select the **Green** line pen.
- Click **OK** to redraw the mesh in the new



colour.

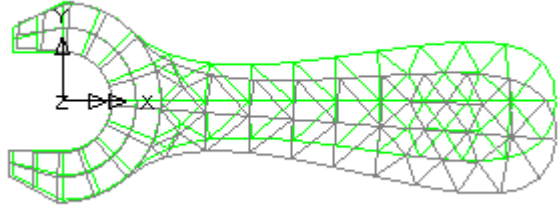

- Double click on the **Deformed mesh** layer in the  Treeview to display the deformed mesh layer properties.
- Click the **OK** button to select the defaults and display the deformed mesh.



Principal stress vector plots

Principal stresses can be plotted as vectors with different colours being used to signify tension and compression.

The mesh layer is no longer required and it will now be hidden.

- Click the right-hand mouse button on the **Mesh** entry in the  Treeview and select the **On/Off** option.
- Click the right-hand mouse button in a blank part of the view window and select the **Vectors** option to add the vectors layer to the  Treeview.

The vector properties dialog will be displayed.

- Select **Stress** vector results of **Principal** stresses from the entity drop down list.
- Click the **OK** button to display the vector plot with tension vectors shown in red and compression vectors shown in blue.

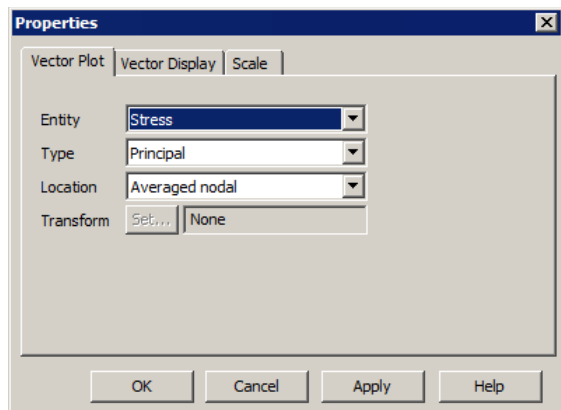

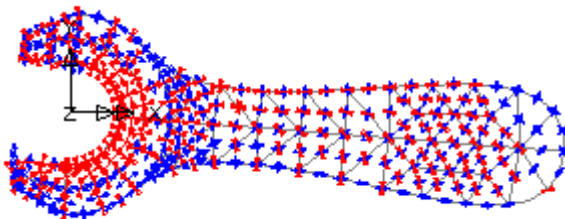



Creating new view windows

As an alternative to hiding, adding or removing layers from the  Treeview for each type of results to be displayed in a single view window, multiple view windows can be defined. New views can be created using default settings, or existing views can be saved before being applied to new views.

Window
New Window

This creates a new view window with default view layers of Mesh, Geometry, and Attributes. In the  Treeview, a new folder for **spanner.mdl Window 2** will appear.

- In the Window 2 folder in the  Treeview, turn-off the **Geometry**, **Attributes** and **Deformed** mesh layers
- In the  Treeview, Loadcase 1 will be set active by default.

Using page layout mode

The model was created using a Working Mode view which allows a model of any size to be created. Results could be viewed using this mode of operation, but in order to allow additional information to be added without obscuring the model, Page Layout Mode can be used instead.

View
Page Layout
Mode...

The view window will resize to show the model view fitted on a piece of paper.

File
Page Setup...

- Ensure that the **Landscape** option is selected and that left, right, top and bottom page **Margins** of **60, 10, 10, 10** respectively are set.
- Click the **OK** button.

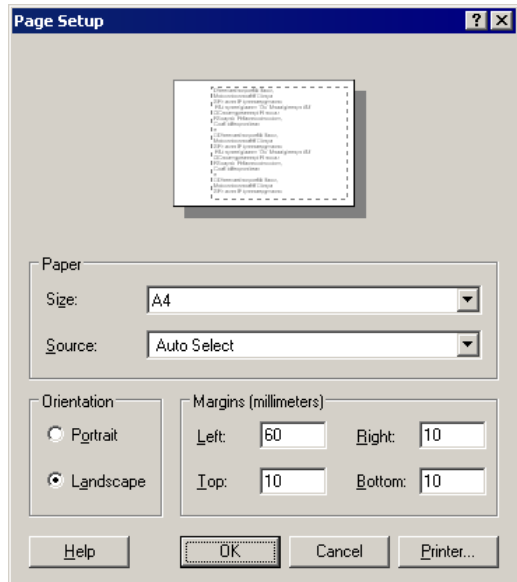

Von Mises stress contour plot

Contours of von Mises Stress (Equivalent Stress) may be plotted as lines or as colour-filled contour ranges. To display stress contours the contour layer needs to be added to the  Treeview.

- With no features selected, click the right-hand mouse button in a blank part of the active window and select the **Contours** option to add the contours layer to the  Treeview.

The contour plot properties dialog will be displayed.

- Ensure that **Stress** contour results are selected from the Entity drop down list, equivalent stresses **SE** from the Component list, and **Averaged nodal** are selected from the Display list.
- On the same dialog select the **Contour Display** tab and ensure that the **Contour key** button is selected.

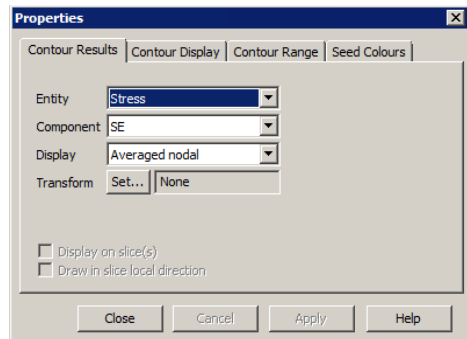



- Click the **OK** button to display the contour plot of equivalent stress along with the contour key.

Re-ordering layers in the Treeview

The order of the layers in the  Treeview governs the order in which the layers are displayed.

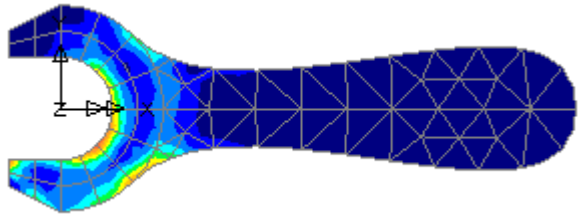
To see the mesh layer on top of the contours the mesh layer must be moved down the  Treeview list to a position after the contour layer.



- In the  Treeview select the **Mesh** layer within Window 2, and drag and drop the Mesh layer name on top of the contour layer name. The mesh layer name will then follow the contour name and the mesh itself will then be displayed on top of the contour layer.



Note. This ordering of layer names can also be done using the right-hand mouse button and selecting the **Move Down** option from the context menu presented.

Moving the contour key and setting significant figures

- In the  Treeview double-click Contours to open the properties dialog.
- Select the **Contour Display** tab and press the **Details** button next to the **Contour key** option.
- Set the X position to **125mm From left of paper**, and the Y position to **10mm From top of paper**.
- Limit the Significant figures to **4** and press **OK** to return to the contour properties dialog.
- Press **OK** to save changes and see the contour key position centrally near the top of the page.



Note. The contour key can also be moved (more easily) graphically by selecting any text or contour key colouring and dragging the key to a new position.

Marking peak values

- With no features selected click the right-hand mouse button in a blank part of the view window and select the **Values** option to add the values layer to the  Treeview.

The values properties dialog will be displayed.

- Ensure **Stress** contour results from the Entity drop down list, equivalent stresses **SE** from the Component list, and **Averaged nodal** from the Location list are selected.
- On the same dialog, select the **Values Display** tab and set **Maxima** values to display the top **1%** of results. (This will show the peak stress value)

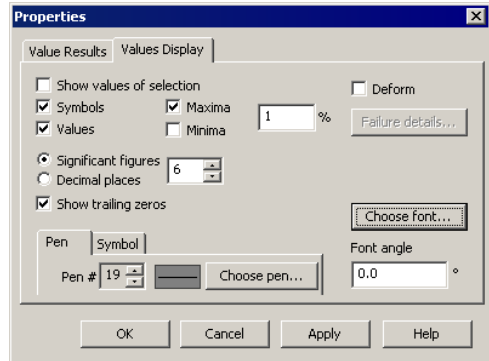

- Click the **OK** button to add the peak values to the contour plot.



Use the Zoom in button to enlarge the view of the spanner to check the number obtained.



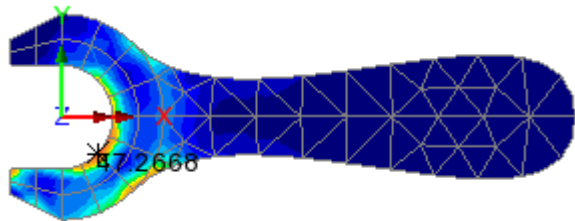

Press the Resize button to fit the model to the full view window.



Saving view windows



View layers and settings defined for a view can be saved for use with other view windows and for use within reports.

- Accept the default settings presented and press the **OK** button to create a Saved view entry  'View 1' in the Utilities  treeview.

To update a view with the settings from a saved view:

- Create a New Window using the **Window > New Window** main menu item.

Window
Save View

- Click on the Utilities  treeview and drag and drop the Saved view entry  for **View1** onto the newly created view window. This updates the newly created view to show those layers and settings saved with View 1.



Note. It is very useful to name a saved view with a name that reflects the contents of the view. For example, saved view names of ‘Contours of SE’, or ‘Maximum displacement, or ‘Isometric view’ might be used, when relevant.

Creating a slice section of results

Section slicing of the model to create graphs of results is to be done with the model lying orthogonal to the screen.

-  Press the Home button to ensure that the model is viewed correctly.
- Ensure the **Snap to grid** button is selected and a grid size of **10** is specified.
- Click the **OK** button.

Utilities

Graph Through 2D...

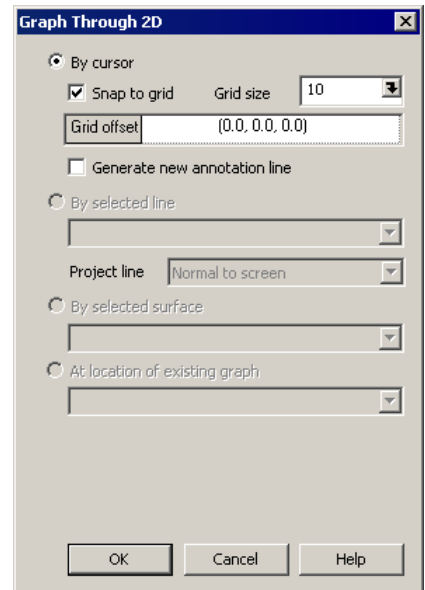

- Click and drag the cursor as shown (at the X=40 location) to define a section slice through the handle of the spanner where it joins the jaws.

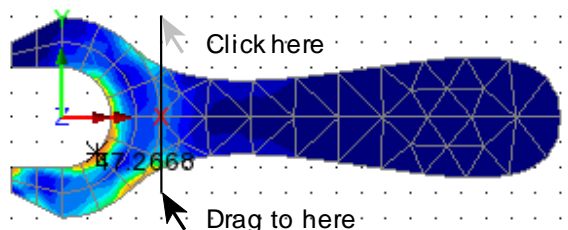

The loadcase and extent of

Linear Elastic Analysis of a Spanner

the slice must now be defined:

- Ensure that **Loadcase 1** and an extent of **Visible model** are selected, and Click the **Next** button.

This leads directly on to creating a graph using the graph wizard:

Selecting the slice data results to be plotted

In this example a graph is to be plotted of the variation in stress through the specified section of the spanner. The X axis results of distance through the spanner have been defined by the section slice. The Y axis results now need to be specified.

- On the Slice data dialog, ensure **Stress** - contour results from the Entity drop down list, and equivalent stresses **SE** from the Component list are selected.
- Click the **Next** button to define the Y axis results.

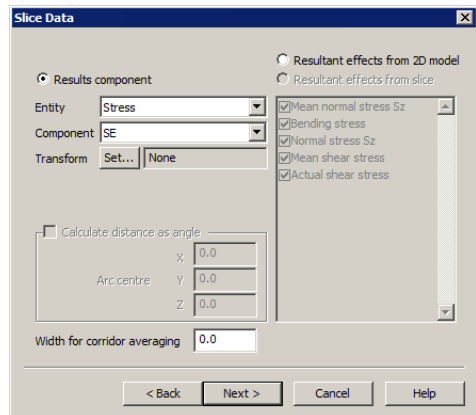

Title information for the graph is now to be added:

- Enter the graph title as **Stress at neck section**
- Enter the X axis label as **Distance along section**
- Enter the Y axis label as **Equivalent Stress (N/mm²)**
- Deselect the **Show symbols** button.
- Click the **Finish** button to display the graph in a new window and show the values used in an adjacent table.

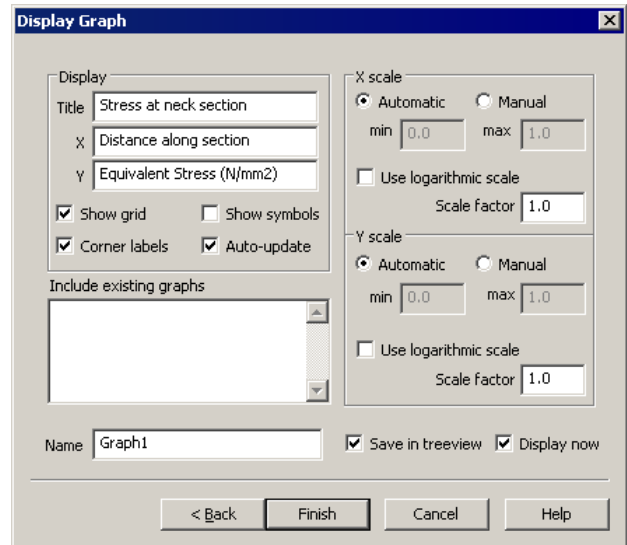

Note. If the graph title or axes labels are left unspecified Modeller will use default names.

	Coordinates (40,-60,0) to (40,-60,0)(1)	SE - 1:Loadcase 1(2)
1	0.0	17.3387
2	2.97149	12.9571
3	6.62078	13.2686
4	20.3303	14.9174
5	34.0399	16.5843
6	37.6892	21.8758
7	40.6606	30.0256

spanner.mdl

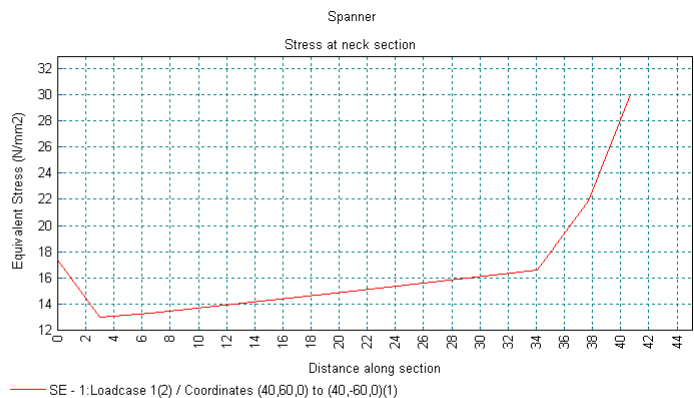

Units: N,mm,t,s,C



Note. The properties of the graph may be modified by clicking on the graph with the right-hand mouse button and selecting the **Edit Graph Properties** option.



Close the graph window, and return the view window.

Linear Elastic Analysis of a Spanner



To exit from the Graph Through 2D option click the **Select Any** cursor button. The grid will be removed.

This completes the example.