

Staged Construction of a Concrete Tower with Creep

| | |
|--------------------------|------------------------|
| For LUSAS version: | 19.0 |
| For software product(s): | Any Plus version. |
| With product option(s): | Nonlinear and Dynamic. |

Description

A 20m high concrete tower of varying cross-section is to be constructed in four stages, each 5 metres high. The formwork is struck 14 days after each stage is cast and the casting sequence between each stage is 60 days.

Simplified geometry has been used to allow the example to concentrate on the creation of staged construction loadcases, the definition of the concrete creep properties, and running a creep analysis.

Concrete creep is carried out according to CEB-FIP 1990 code. The modelling units used are N, mm, t, s, C throughout.

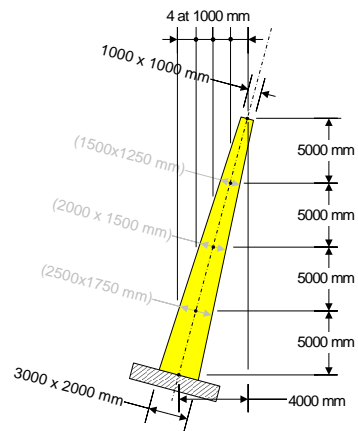

Tower geometry and construction stages

Objectives

The required output from the analysis consists of:

- A comparison of the moments at the base of the tower after each construction stage.
- Maximum displacement of the tower after each construction stage and the change in the maximum displacement value due to long-term creep.

Keywords

3D, Staged Construction, Activate, Deactivate, Long-Term, Creep, CEB-FIP Concrete Model, Age, Casting, Reference Path

Associated Files



- **concrete_tower_modelling.vbs** carries out the modelling of the example.

Discussion

Structural concrete is unique among the major construction materials in that it undergoes time-dependent changes in its properties. Generally, the concrete's strength will increase over time, but this increase in strength is accompanied by a certain degree of shrinkage and creep. Particularly in large structures where several concrete pours may take place over a period of months or years, the time-dependent nature of concrete's behaviour can have a significant effect on the behaviour of the structure and these effects must be considered in analysis.

Modelling

Running LUSAS Modeller

For details of how to run LUSAS Modeller see the heading *Running LUSAS Modeller* in the Examples Manual Introduction.



Note. This example is written assuming a new LUSAS Modeller session has been started. If continuing from an existing Modeller session select the menu command **File** > **New** to start a new model file. Modeller will prompt for any unsaved data and display the New Model dialog.

Creating a new model

- Enter a File name of **concrete_tower**
- Use the default User-defined working folder.
- Ensure an Analysis type of **Structural** is set.
- Select an Analysis Category of **3D**
- Set Model units of **N,mm,t,s,C**
- Select Timescale units as **Days**
- Leave the Startup template set as **None**.
- Ensure the Layout grid is set as **None**
- Enter a Title of **Concrete creep example to model code CEB-FIP 1990**
- Click the **OK** button.



Note. Save the model regularly as the example progresses. Use the Undo button to correct any mistakes made since the last save was done.

Set the Vertical Axis

Setting an analysis category of 3D sets the vertical axis to be the Z-axis. This example requires the vertical axis to be the Y-axis.

On the Model Properties dialog set the vertical axis to be the **Y-axis**.

Tools
Vertical axis...

Defining the Geometry

Geometry >
Line >
By Coords...

 Enter coordinates of **(0, 0)**, and **(1000, 5000)**, to define the first section of the tower.

- Select the line just drawn.

Geometry
Line >
Copy...

 Enter a translation in the **X** direction of **1000** and in the **Y** direction of **5000**

- Enter the number of copies required as **3** and click **OK** to create the next three sections of the tower.

Defining and Assigning Mesh Attributes

- The tower is to be modelled with **Thick Beam, Quadratic** elements (BMI31 elements) with **6** divisions. These elements can correctly capture the effects of the variation in section shape.
- Enter the attribute name as **BMI31 6Div** and click **OK**.
- Select all lines on the model and drag and drop the **BMI31 6Div** mesh from the  Treeview onto the selected features.
- Click **OK** to assign a default element orientation using a beta angle of **0**.



Caution. If constant cross-section beam elements were to be used to model the variation in section shape instead of the quadratic elements used, care should be taken to ensure that the line mesh was sufficiently fine to correctly capture the effects of the variation in section shape.

Geometric Properties

There are two ways that the tapering shape of the tower could be modelled. The first option would be to create a tapering beam geometric property for each individual line. This would require different geometric attributes to be created for each of the four lines.

A more efficient method is to use a **multi-varying section** geometric attribute which allows tapering along a **reference path** rather than along individual lines. By using this type of geometric attribute, only a single attribute is required to describe the taper of the tower from its base to tip.

To define the tower cross-section at the base

The basic cross-sectional dimensions of sections at the base and top of the tower will be defined.

- On the Rectangular Solid Section Property dialog enter **D=3000** and **B=2000**.

A name of RSS D=3000 B=2000 will be automatically created.

- Ensure **Add to local library** is selected and click **Apply** to calculate the section properties, add the section to the local library and define another cross-section.
- Change the values to read **D=1000** and **B=1000**.

A name of RSS D=1000 B=1000 will be automatically created.

- Ensure **Add to local library** is selected and click **OK** to calculate the section properties and add the section to the local library.

Attributes
Mesh >
Line...

Tools
Section Property
Calculator >
Rectangular
Sections > Solid

All required section properties have now been defined and saved in the local user library. They will be used to create multiple varying section line attributes which will be automatically added to the Attributes treeview when the attribute is created.

Creating a reference path

For this example a reference path will be defined along the lines representing the tower. This will be used when defining and assigning the varying section properties of the tower.

- Box-select all lines representing the tower

Leave the name set as **Path 1** and click **OK**.

The direction of the path is shown by arrows now overlaid on each line.

Note. Model geometry can be used to generate a reference path but no subsequent connection between the initial parent geometry and reference path data exists.

The visualisation of a reference path can be controlled via the Utilities layer. If desired reference path visualisation can be turned off using a context menu option for its entry in the Utilities layer of the Treeview.

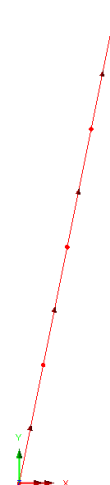



Utilities
Reference Path



Defining the multiple varying section line property

A multiple varying geometric line attribute needs to be defined. This will make use of the previously defined rectangular solid sections.

Define sections

- On the Multiple Varying Section dialog click in the Section cell that currently reads 914x305x289kg UB and the launch dialog button  will appear to allow a different pre-defined section to be chosen from a different section library.
- On the Enter Section dialog, click on the drop-down list button  to change the selection from UK Sections to **User Sections**
- Ensure a **Local** library is being accessed.
- Select **RSS D=3000 B=2000** from the list of local library items and then click **OK** to add the section to the first row of the table on the Multiple Varying Section dialog.
- On the Multiple Varying Section dialog press the **TAB** key to move between cells and create a new row beneath the existing row.

Attributes
Geometric >
Multiple Varying
Section...

Staged Construction of a Concrete Tower with Creep

- In the new Section cell (row 2) click on the launch dialog button  again. The drop-down list should still be showing **User Sections** for a **Local** library. Browse and select **RSS D=1000 B=1000** from the drop-down list and click **OK** to add the section to the table.



Note. Before a visualisation of the longitudinal and horizontal alignment of the cross-section shapes can be displayed on the dialog, the shape interpolation method and distance values need to be defined.

Define shape interpolation method

To specify a shape interpolation method for each defined section:

- The **RSS D=3000 B=2000** section as the first in the table is set by default to **Start**
- For the **RSS D=1000 B=1000** section entry click on the drop-down list button  in the Shape Interpolation cell and select **Linear**

Define distance values

- Change the distance interpretation to be **Along reference path** and ensure **Path1** is selected.

Lastly a distance value at which the section will apply should be specified.

- For the **RSS D=1000 B=1000** section click in the Distance cell and enter **20397** (the true length of the tower).



Note. When specifying a distance value at which a defined section will apply it is important to round-up to the next whole number (20397 in this case). If 20396 has been specified the final section would not be applied to the topmost line on assignment, and therefore not shown when fleshed.

Check alignment settings

The vertical and horizontal alignment of a pair or series of sections is controlled by the Alignment options. All sections are aligned with respect to a chosen section.

- Select **Centre to centre** for both alignment options and set the section to align to as **1**.

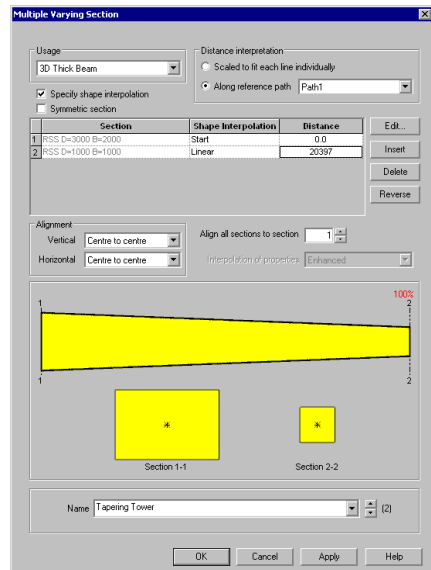

Name the attribute

- Enter a name of **Tapering Tower** and click **OK** to add the multiple varying section line attribute to the  Treeview. Note that “(Varying – 2 sections)” is automatically appended to the stated name.

Assigning the varying geometric line property

- Box-select all lines representing the tower and drag and drop the **Tapering Tower (Varying – 2 sections)** geometric line attribute from the  Treeview onto it.





Note. After a short pause, whilst section property data is calculated for each element along the assigned line, the tower section shape will be visualised.

Check and correct the orientation of sections used



Select the isometric view.

In this example, the 3m x 2m section at the base of the tower has not been oriented correctly for the line axes that are in use. As a result the cross sections at the bottom and the top of the tower both need rotating around their centroids. This is done as follows:

- In the  Treeview double-click on the **Tapering Tower (Varying – 2 sections)** attribute name
- On the **Multiple Varying Sections** dialog click in the Section cell for row 1 and click on the launch dialog button  to access the detail for **RSS D=3000 B=2000** and change the Rotation about centroid to be **90** degrees and click **OK**.
- Click in the Section cell for row 2 and click on the launch dialog button  to access the detail for **RSS D=1000 B=1000** and change the Rotation about centroid to be **90** degrees and click **OK**.

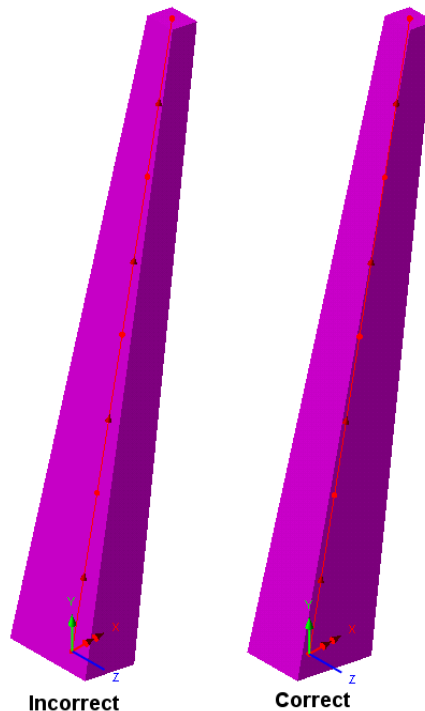

Material Properties

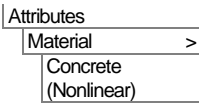

- Ensure the concrete model **Linear with creep/shrinkage (model 86)** is selected.
- Ensure that creep model code **CEB-FIP (1990)** is selected.
- Ensure that Shrinkage mode code **CEB-FIP (1990)** is selected.
- Press the **Options** button, and on the Concrete dialog that appears, specify that notional size is to be **Calculate using section dimensions or thickness (lines and surfaces)**, and click **OK**.
- Back on the Concrete (Nonlinear) dialog, enter Young's modulus to be **30E3**.
- Enter **0.2** for Poisson's ratio.
- Enter **2.4E-9** for Mass density.
- Tick the **Thermal properties** box and ensure a value of **10E-6** is used
- Enter a Uniaxial compressive strength of **48.0** and ensure the remaining settings are as shown on the dialog above.
- Enter a material name of **Concrete CEB-FIP Creep** and click **OK** to create the material attribute.
- Select the whole model (**CTRL + A**). From the  treeview drag and drop the **Concrete CEB-FIP Creep** attribute onto the model to assign it.



Notes. The CEB-FIP creep calculations use a parameter called 'notional size':

- When the 'Calculate using section dimensions or thickness' option is specified the notional size is calculated as $2A/U$ where A is the area of the cross-section and U is the length of the cross-section perimeter.

| Component | Value |
|----------------------------------|---------|
| Young's modulus | 30.0E3 |
| Poisson's ratio | 0.2 |
| Mass density | 2.4E-9 |
| Coefficient of thermal expansion | 10.0E-6 |

| Component | Value |
|-------------------------------|---------------------------|
| Uniaxial compressive strength | 48.0 |
| Cement type | Normal or rapid hardening |
| Relative humidity | 70.0 |

Name: Concrete CEB-FIP Creep (1)

- ❑ When the 'Internal perimeter factor for voids' option is specified a factor applied to the perimeter length of any internal voids when calculating the section perimeter U.
- ❑ When the 'Specified directly' option is chosen the notional size may be stated explicitly.

Supports

Attributes
Support...

- A fully fixed support is required therefore all degrees of **translation** and **rotation** in the **X, Y** and **Z** axes must be set as **Fixed**. Enter an attribute name of **Fully Fixed** and click **OK**
- Select the point at the base of the tower and from the  treeview drag and drop the support attribute **Fully Fixed** onto the selected feature, ensure the **All analysis loadcases** option is selected and click **OK**

Loading

Only self weight will be applied in this analysis. The LUSAS auto-gravity facility can be used to quickly apply gravity loading in all loadcases. This will be done later on after creation of all the required loadcases.

Age

The age of a section within a creep analysis is important because the material properties change with time. The age of a section is specified in days between the casting of the section and when it is first activated in the analysis.



Note. The timescale units of days for the model were set on the New Model dialog at the beginning of this example. Timescale units are distinct from the fundamental model units (i.e. N, mm, t, s, C) and are provided as a convenience for long-duration analyses like creep and consolidation.

Creating and Assigning an Age Attribute

Attributes
Age...

- It is assumed that all sections in the tower will be cast and the formwork struck **14** days after the component was first activated. (If this was not the case separate age attributes would be created and assigned to each section as required). The Age at which shrinkage begins is also considered to be **14** days.

- Name the attribute as **14 days to formwork strip** and click **OK**

Staged Construction of a Concrete Tower with Creep

- Assign the age attribute to all lines in the model.



Note. If a construction includes precast sections, the age of a component might be 80 days, while the component may be activated at day 28 in the analysis for example.

Creating Activation and Deactivation datasets

In order to carry out a creep analysis on the model the construction stages are modelled using the activate and deactivate facility within LUSAS.

Attributes

Activate and
Deactivate...

- Select the **Activate** option and click **Next**
- Enter the attribute name as **Activate** and click **Apply**. Then click **Back** so the dialog can be reused to define the deactivate attribute.
- Select the **Deactivate** option and click **Next**
- Select the **Percentage to redistribute** option and leave the value as **100%**.
- Enter the attribute name as **Deactivate**, then press **Finish**

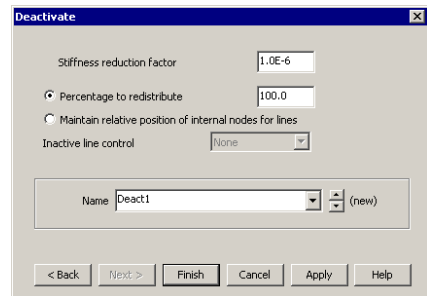

Modelling of Construction Stage 1



Select the Home button to return the model to the default view.

- In the Treeview expand **Analysis 1** and rename **Loadcase 1** to **Stage 1: 0 to 60 Days** by right-clicking its title and selecting **Rename**

All elements in the model which are not required for the first stage analysis need to be de-activated.

- In the graphics window select the top three lines of the tower.
- From the  Treeview drag and drop the deactivation attribute **Deactivate** to the three selected lines ensuring that it is assigned to loadcase **Stage 1: 0 to 60 Days**

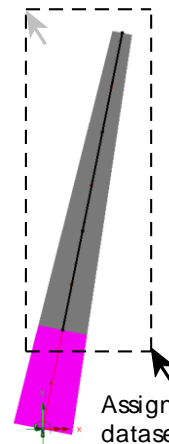

Assign deactivation dataset to top 3 stages of construction

Defining loadcase properties

- In the Treeview right-click **Stage 1: 0 to 60 Days** and, from the **Controls** menu item, select the **Nonlinear & Transient** menu option.



Note. The total response time of 60 represents the 60-day time interval until the next stage of the analysis is activated.

- On the Nonlinear & Transient dialog select the **Nonlinear** option in the top-left hand corner and leave the incrementation type as **Manual**.
- Enable the **Time domain** option. Select a **Viscous** time domain from the drop-down options. Enter the **initial time step** as **4**, the **total response time** as **60**, and set the **maximum number of time steps or increments** as **15**
- In the incremental LUSAS file output section enter a **Plot file** value of **5** to only write out the results every 5 time steps. This will simplify the viewing of the results by only creating a results file for the final time step of each loadcase.

Nonlinear & Transient

Incrementation

Nonlinear

Incrementation: Manual

Starting load factor: 0.1

Max change in load factor: 0.0

Max total load factor: 1.0

Adjust load based on convergence

Iterations per increment: 4

Displacement reset

Time domain

Time domain: Viscous

Initial time step: 4

Total response time: 60

Automatic time stepping

Solution strategy

Same as previous loadcase

Max number of iterations: 12

Residual force norm: 0.1

Incremental displacement norm: 1.0

Incremental LUSAS file output

Same as previous loadcase

Output file: 1

Plot file: 5

Restart file: 0

Max number of saved restarts: 0

Log file: 1

History file: 1

Save a restart at the end of this control



Common to all

Max time steps or increments: 15

OK Cancel Help

- Having set all the Nonlinear & Transient options select **OK** to return to the Modeller working window.

Staged Construction of a Concrete Tower with Creep



A Nonlinear and Transient object  will be added to the  Treeview. Double-clicking on this object will allow any changes to be made to the control properties.

Construction Stages 2 to 4

Stages 2 to 4 require loadcases to be generated to specify the duration of the construction process. Lines on the model must be selected according to the construction stage being considered and activation datasets must be assigned to these lines as instructed below. For this example, gravity is not assigned to each loadcase during its creation. Instead, it is assigned later, as a property of the analysis.

Stage 2

The elements in the second construction stage must be activated

- Enter the Loadcase name as **Stage 2: 60 to 120 Days** and select **OK**
- In the  Treeview select **Stage 2: 60 to 120 Days** using the right-hand mouse button select **Set Active**
- In the graphics window select the second line of the tower.
- With the second stage selected, assign the activation attribute **Activate** from the  Treeview ensuring that it is assigned to loadcase **Stage 2: 60 to 120 Days**

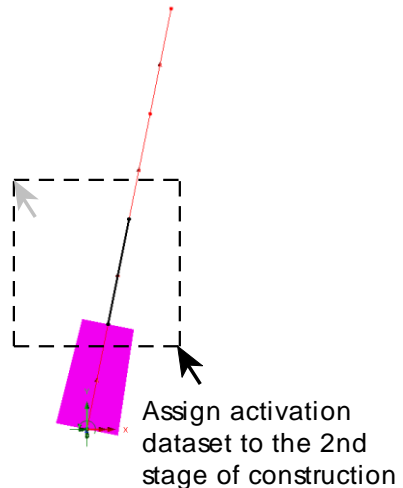

Defining loadcase properties

- In the  Treeview right-click **Stage 2: 60 to 120 Days** and, from the **Controls** menu item, select the **Nonlinear & Transient** menu option.
- On the Nonlinear & Transient dialog select the **Nonlinear** option in the top-left hand corner and leave the incrementation type as **Manual**
- Select the **Time domain** option and select a **Viscous** time domain. Enter the **initial time step** as **4**, the **total response time** as **120**, and the **maximum number of time steps** as **15**.
- Ensure **Same as previous loadcase** is selected for the **Incremental LUSAS file output**.



- Select **OK** to return to the Modeller working window.

Stage 3

The elements in the third construction stage now need to be activated.

Analyses

Loadcase...

- Enter the Loadcase name as **Stage 3: 120 to 180 Days** and select **OK**
- In the  Treeview right-click **Stage 3: 120 to 180 Days** and select **Set Active**
- In the graphics window select the third stage of the tower.
- With the third stage selected, assign the activation attribute **Activate** from the  Treeview, ensuring that it is assigned to loadcase **Stage 3: 120 to 180 Days**

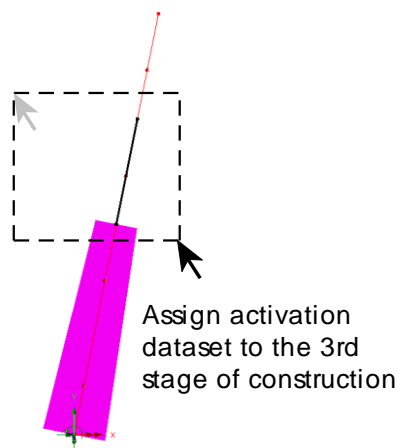

Defining loadcase properties

- In the  Treeview right-click **Stage 3: 120 to 180 Days** and, from the **Controls** menu item, select the **Nonlinear & Transient** menu option.
- On the **Nonlinear & Transient** dialog select the **Nonlinear** option in the top-left hand corner and leave the incrementation type as **Manual**
- Select the **Time domain** option and select a **Viscous** time domain. Enter the **initial time step** as **4**, the **total response time** as **180** and the **maximum number of time steps** as **15**.
- Ensure **Same as previous loadcase** is selected for the **Incremental LUSAS file output**.
- Press **OK** to return to the Modeller working window.



Verifying self weight and activation assignments

If you need to verify loading assignments such as self weight or to check when particular lines (and hence elements) become active in an analysis select a line on the model using the right-hand mouse button and select **Properties**. Select the **Activate Elements** tab. Note that the 'greyed-out' loadcase is simply the current loadcase and may not be the actual loadcase that the properties are assigned to. Selecting the

Activate entry in the table of Assigned properties will show the loadcase to which the activation is assigned.

Stage 4

The elements in the fourth construction stage need to be activated.

- Enter the Loadcase name as **Stage 4: 180 to 240 Days** and select **OK**
- In the  Treeview right-click **Stage 4: 180 to 240 Days** and select **Set Active**
- In the graphics window select the top line of the tower.
- Drag and drop the activation attribute **Activate** from the  Treeview ensuring that it is assigned to loadcase **Stage 4: 180 to 240 Days**

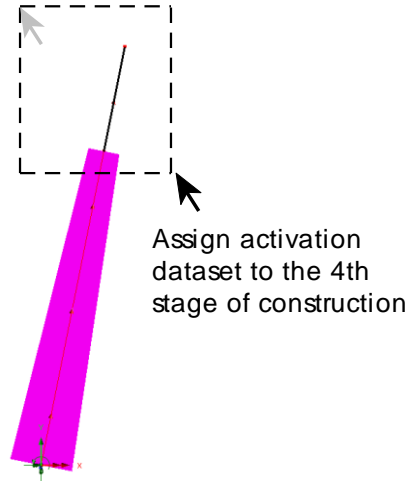

Defining loadcase properties

- In the  Treeview right-click **Stage 4: 180 to 240 Days** and, from the **Controls** menu item, select the **Nonlinear & Transient** menu option.
- On the Nonlinear & Transient dialog select the **Nonlinear** option in the top-left hand corner and leave the incrementation type as **Manual**
- Select the **Time domain** option and select a **Viscous** time domain. Enter the initial time step as **4**, the total response time as **240** and the maximum number of time steps as **15**. Select **OK** to return to the Modeller working window.
- Click **OK** to return to the Modeller working window.

Long-term loadcase

This investigates long-term effects on the tower over time.

- Enter the Loadcase name as **Long-term: 240 to 1000 Days**
- In the  Treeview right-click loadcase **Long-term: 240 to 1000 Days** and select the **Nonlinear & Transient** option from the **Controls** menu.

Analyses
Loadcase...

Analyses
Loadcase...

- On the Nonlinear & Transient dialog select the **Nonlinear** option in the top-left hand corner and leave the incrementation type as **Manual**
- Select the **Time domain** option and select a **Viscous** time domain. Enter the initial time step as **1**, the total response time as **1000** and the maximum number of time steps as **20**.
- Select the **Advanced** button, and on the Advanced time step parameters dialog select the **Exponent for increasing time step** option and set the value to **2**. Press **OK** to return to the Nonlinear & Transient dialog.
- Having set all the Nonlinear & Transient options select **OK** to return to the Modeller working window.

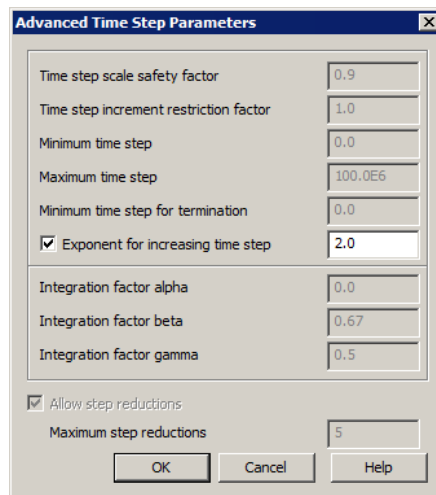

Note. Specifying an **exponent for increasing time step** will cause the time step increments to increase in duration throughout a loadcase. This is particularly useful with creep analyses where it is often desirable to start a loadcase with short time steps but progress to larger time steps as the age of the concrete increases to investigate long-term behaviour without using an excessive number of time steps. The larger the value specified in the **exponent for increasing time step** box, the greater the ratio of the final to first time step size will be. The analysis will always use the number of time steps specified in the **max time steps or increments** box.



Note. All lines in the model are now activated so no activation dataset needs to be assigned to the model for this loadcase.

Applying Gravity as a property of the analysis

Now that all five loadcases have been created, in the  treeview right-click the heading **Analysis 1** and select **Add gravity**. This will automatically assign gravity loading to all loadcases, as shown by the addition of a loading arrow to the loadcase icons.

File
Save



Save the model file.

Running the Analysis



Click the **solve now** button and press **OK** to run the analysis using LUSAS Solver and load the results file

If the analysis is successful...

Analysis loadcase results are added to the  Treeview.

In addition, 2 files will be created in the Associated Model Data folder in the directory where the model file resides:



- **concrete_tower.out** this output file contains details of model data, assigned attributes and selected statistics of the analysis.
- **concrete_tower.mys** this is the LUSAS results file which is loaded automatically into the  Treeview to allow results processing to take place.

If the analysis fails...

If the analysis fails, information relating to the nature of the error encountered are written to the .out file in addition to the text output window. Any errors listed in the text output window should be corrected in LUSAS Modeller before saving the model and re-running the analysis.

Rebuilding a Model

If it proves impossible for you to correct the errors reported a file is provided to enable you to re-create the model from scratch and run an analysis successfully.



- **concrete_tower_modelling.vbs** carries out the modelling of the tower.

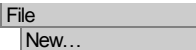

Start a new model file. If an existing model is open Modeller will prompt for unsaved data to be saved before opening the new file.

Enter the file name as **concrete_tower**

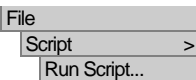

- To recreate the model, select the file **concrete_tower_modelling.vbs** located in the `<LUSAS Installation Folder>\Examples\Modeller` directory.





Rerun the analysis to generate the results.

Viewing the Results

Analysis loadcase results for each time step are added to the  Treeview. The results for the last load increment (for the Long term loadcase) are set to be active by default.

Bending moments of M_z at the base of the tower are to be investigated for each stage of the construction process, that is, after 60 days, 120 days, 180 days, 240 days and for a long-term loadcase from 240 to 1000 days. A summary of results on each results plot also allows a comparison of maximum displacements for each stage.

Preparation to view stage results

- Turn off the **Geometry**, **Utilities** and **Attributes** layers in  Treeview.
- Press the Resize button  to turn off automatic resizing of the model.
- Double-click the  **View Properties** control object in the  Treeview. Select the **View** tab and ensure the check box **Show only activated elements** is ticked. Press **Close** to apply changes and return to the model.
- With no features selected, click the right-hand mouse button in a blank part of the Graphics window and select the **Diagrams** option. On the dialog, select **Force/Moment** contour results from the entity drop down list and component **M_z** .
- Select the **Diagram Display** tab and ensure **Label values** and **Peaks only** are ticked. Press the **Label font...** button to set the diagram font as **Arial, Bold**, size **14**. Press **OK** to return.
- With no features selected, click the right-hand mouse button in a blank part of the Graphics window and select the **Values** option. On the dialog, select **Displacement** results from the entity drop down list and component **RSLT**.
- Select the **Values Display** tab and select the **Deform** option to plot values on the deformed mesh. Choose the decimal places options and set this to 1. Press **OK** to finish.
- Select the **Scale** tab select **Use a local scale** and **Specify magnitude** with a value of **10mm**. Click **OK** to display the diagrams layer.

Stage 1 results

- In the  Treeview, right-click on **Time Step 15 Time = 60.000** (days) and select the **Set Active** option.

The maximum bending moment is shown at the base of the tower, and the maximum displacement is reported at those nodes at the top of the tower.

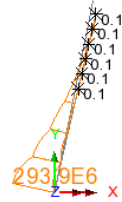

Stage 2 to 4 results

- In the  Treeview right-click on the loadcases noted in the following summary table, and select the **Set Active** option to update the diagram results.

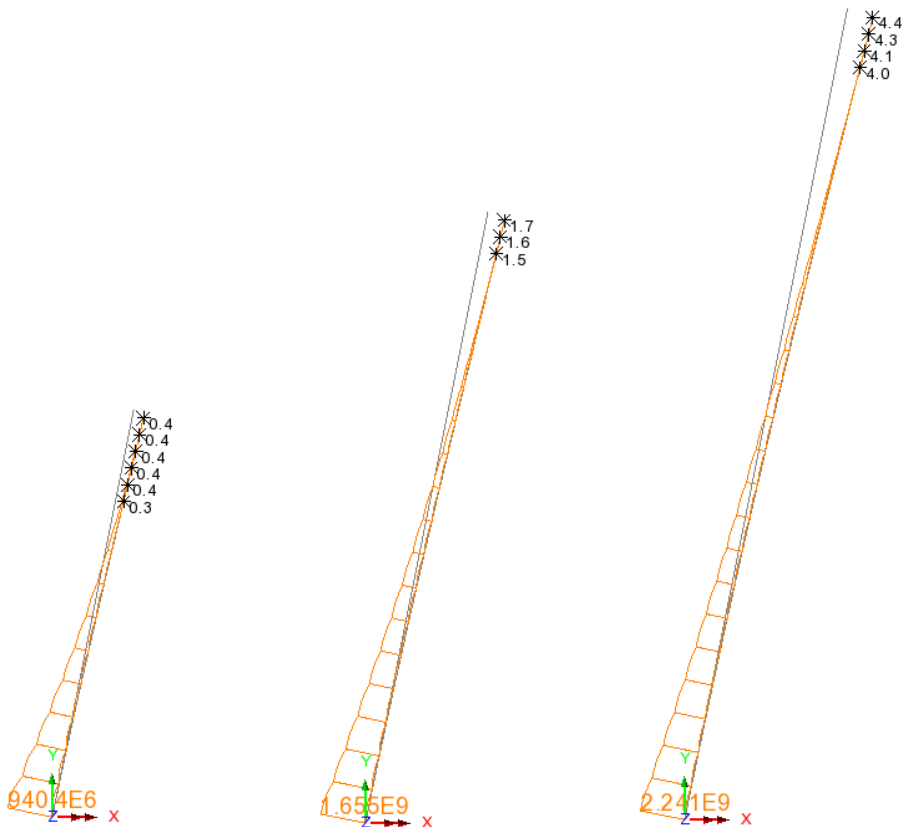

Time Step 30
Time = 120.000

Time Step 45
Time = 180.000

Time Step 60
Time = 240.000

Long-term loadcase

- In the  Treeview right-click on **Time Step 79 Time = 1000.00** (days) and select the **Set Active** option.

For the long-term loadcase the bending moment has not changed from the stage 4 analysis since no additional loading has been applied to the model.

However, a comparison of maximum displacement between stage 4 and this long term stage shows an increase due to the effect of the creep deformations.

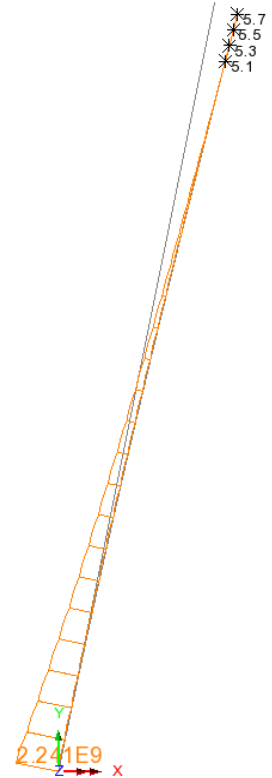

Plotting a Graph of Deflection at Top of Tower

The time-dependent creep effects can be plotted using the LUSAS Graph Wizard.

- Ensure that the **Mesh** and **Deformed mesh** layers are visible,
- Select the node at the top of the tower by holding the **N** key and clicking the node.
- On the first page of the Graph Wizard, select **Time History** and click **Next**.
- For the X-axis entity, select **Named** and ensure **Whole Analysis** is selected. Click **Next**.
- For the X attribute named data, select **Response Time** and click **Next**.
- For the Y-axis entity, select **Nodal** and click **Next**.

Utilities

Graph Wizard...

Staged Construction of a Concrete Tower with Creep

- Select entity **Displacement** and component **RSLT**. The number of the selected node should automatically be entered in the 'specify node' input box. Click **Next**.
- Enter title **Displacement of Tower Tip**, X-axis label **Time (days)** and Y-axis label **Displacement (mm)**. Click **Finish** to plot the graph.

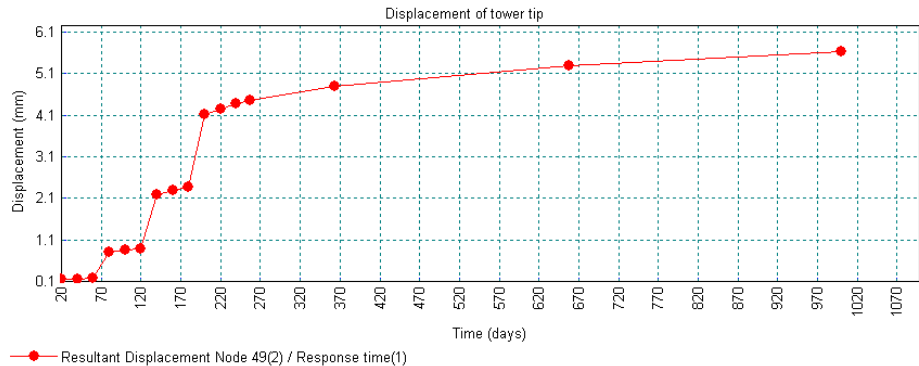

The graph clearly shows the four construction stages, and that the deflection increases with time due to creep and shrinkage effects. Note that the tower tip is not actually activated in the first three construction stages, but deflections of the deactivated mesh can be plotted.

This completes the example.