

Composite Highway Bridge Design

In accordance with the Eurocode
and the UK National Annex

For LUSAS version:	18.0 and above
For software product(s):	LUSAS Bridge or LUSAS Bridge plus
With product option(s):	Steel and Composite Deck Designer (PontiEC4 – V3.2.7) Vehicle Load Optimisation
With additional software	Microsoft Excel installed

Description

The global analysis and design of a simple two span continuous bridge is to be carried out using the Steel and Composite Deck Designer (PontiEC4) and LUSAS Bridge.

The primary aim of this particular example is to show the LUSAS model building requirements to allow a design check with PontiEC4 to be carried out. A separate example ‘Assessment of a Composite Bridge Deck to Eurocodes’ shows the use of the PontiEC4 Composite Deck Designer and the interaction between it and a supplied LUSAS model.

The bridge carries a 2-lane highway over another road.

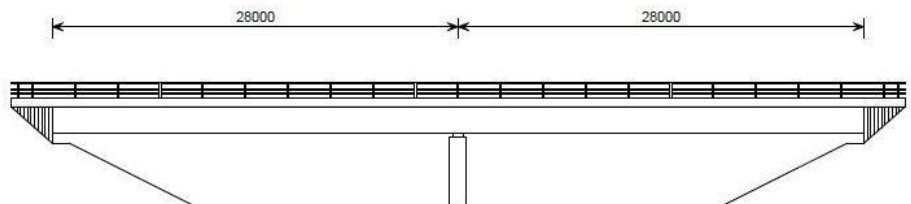

Composite Highway Bridge Design

A four-girder arrangement has been chosen, and a deck slab thickness of 250 mm has been assumed. The girders are spliced at a distance of 6.3m either side of the central pier, giving overall girder lengths of 21.7, 12.6 and 21.7m respectively.

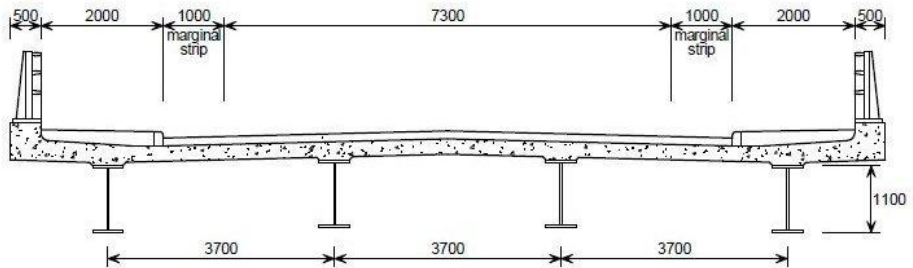
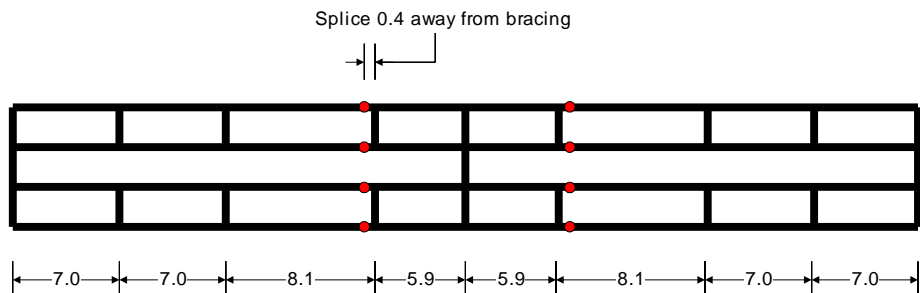

Table of main girder properties

	21.7 m span girder	12.6 m pier girder	21.7 m span girder
Top flange	500 x 25	500 x 40	500 x 25
Web	12	18	12
Bottom flange	500 x 50	650 x 60	500 x 50
Top rebars	B16 @ 150mm	B25 @ 150mm	B16 @ 150mm
Bottom rebars	B16 @ 150mm	B25 @ 150mm	B16 @ 150mm

Bracing arrangement



Objectives

This shows how the Steel and Composite Deck Designer (PontiEC4) and LUSAS Bridge can be used to carry out the analysis and design of the bridge shown previously.

Keywords

Steel, Composite, Deck, Designer, Vehicle Load Optimisation, PontiEC4, Design, Checking, Import, Export, ULS, SLS, Detailed design.

Associated files



- LUSAS_Comp_Bridge.csv** - Contains initial material and geometric data / definitions for use with PontiEC4
- Sections_Rev0.vbs** - A file created by PontiEC4 containing geometric section data to import into LUSAS. A supplied file is only for use in case of difficulties in manually creating the appropriate data.
- LUSAS_Shrinkage.vbs** - A file created by PontiEC4. A supplied file is only for use in case of difficulties in manually creating the appropriate data.
- LUSAS_Thermal.vbs** - A file created by PontiEC4. A supplied file is only for use in case of difficulties in manually creating the appropriate data.
- LUSAS_Comp_Bridge.mdl** – Model file created by a user. A supplied LUSAS model file is only for use in case of difficulties in manually creating the appropriate model.
- Forces_and_moments.xls** – File created by the LUSAS Export Forces and Moments dialog containing data to import into PontiEC4. A supplied file is only for use in case of difficulties in manually creating the appropriate data.
- Export_Forces_to_PontiEC4.inp** - File containing dialog selections made on the Export Forces and Moments dialog.
- LUSAS_Comp_Bridge_Results.csv** – Contains revised geometric data / definitions for use with PontiEC4
- Forces_and_moments_optimised.xls** File created from a modified LUSAS analysis model (not supplied) containing data to import into PontiEC4.

Structural Idealisation



Note. It is understood that the bridge should have different section properties for the internal girders and the external girders due the differences in widths of slab associated with each girder. This is due to the cantilever being shorter but thicker than half the width of slab between girders. So, in reality, the analysis should have different section

properties for both the internal and external girders. However for training purposes the section properties will be based on the cross section shown below. This is a gross simplification but has been done to keep the data creation simple for this example.

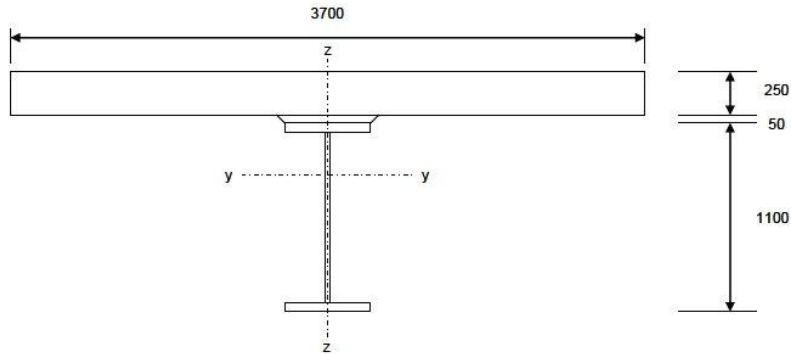

For the purposes of this example, only two locations will be considered for detailed design. In reality many locations would need to be considered to cover the full design of the bridge, but for training purposes this simplification will be accepted.

Design checks will be carried out:

- Along girder 2 (the first internal girder), towards the middle of span 1
- Over the pier support.

Part 1: Enter section and material data in Steel and Composite Deck Designer (PontiEC4)

Running Steel and Composite Deck Designer (PontiEC4)

- Run the Steel and Composite Deck Designer (**PontiEC4**)
- Select the **File> New** menu item to create a new project.
- Select the **File> Save as** menu item to save the Steel and Composite Deck Designer (PontiEC4) dialog data to a working project folder different from the installation folder (this would normally be a project folder in which a LUSAS model will also be created), with the name **LUSAS_Comp_Bridge.csv**



Note. All data entered in the Steel and Composite Deck Designer (PontiEC4) dialogs will be saved to this file. Previously created and saved data can be loaded into the Steel and Composite Deck Designer (PontiEC4) dialogs by using the **File> Open** menu item.

Part 1: Enter section and material data in Steel and Composite Deck Designer (PontiEC4)

If this example is undertaken over several sessions ensure that the entered data is saved before exiting so that the example can be picked up from where it was left.

Having started the Steel and Composite Deck Designer (PontiEC4) a number of blank dialogs forms will be presented cascading across the screen as shown below. Through the design process each of these dialogs will be populated with data, starting with the **Material** dialog.

The screenshot shows the 'Material' dialog box in the PontiEC4 software. The dialog is organized into several sections:

- Concrete slab:** Strength fck (N/mm²), Strength fct,el* (N/mm²), Partial factor γ_c , Cement class, Aggregate type, Coeff. of thermal expansion, Max. crack width wk (mm).
- Concrete age:** At onset of drying shrinkage ts (day), At time considered t (day), When perm. load is applied to (day), When shrik. load is applied to (day), When imposed d. are applied to (day), Permanent creep multiplier PaL, Shrinkage creep multiplier PaL, Deformations creep multiplier PaL.
- Modular ratio:** Automatic calculation (selected) / Direct input, n0, nL permanent loads, nL shrinkage, nL imposed deformation.
- Imposed strain in the slab:** Automatic calculation (selected) / Direct input, Shrinkage Deformation, Shrinkage comb. factor, Temperature difference (°C), Temperature comb. factor.
- Environment:** Exposed area (mm²), Exposed perimeter (mm), Relative humidity (%).
- Shear connection:** Ultimate strength fu (N/mm²), Reference values for fatigue strength at 2E6 cycles: shear stress $\Delta\tau_c$ (N/mm²), normal stress $\Delta\sigma_c$ (N/mm²), Partial factors: γ_v , ks (SLS), γ_{FR} , $\gamma_{MR,S}$.
- Steel:** Modulus of elasticity (N/mm²), Poisson's ratio ν , structural steel Grade, reinforcement steel fyk (N/mm²), Fatigue strength: $\Delta\sigma_{Rsk}$ (N/mm²), Partial factors: γ_s , γ_F , γ_{M1} , γ_{MF} , γ_{MFR} , γ_{MFRd} .
- FATIGUE. Damage equivalent factors:** Table with columns for STRUCTURAL STEEL, SHEAR STUDS, and REINFORC. BARS, and rows for damage effects induced by traffic, traffic composition, design life of the structure, and effects of heavy traffic on other slow lanes.



Note. Under the **Windows** menu a list of all the dialog names are presented. Clicking a dialog name in the list will bring that dialog to the front of the screen. This allows for easy navigation around the various dialogs.

In the Steel and Composite Deck Designer (PontiEC4) the units in use are always indicated in the input and output dialogs, and in general forces are expressed in N (Newton), lengths in mm (millimetres) or m (metres), and moments expressed in Nm (Newton metres). The units used for the LUSAS model will therefore be N, m, kg, s, C.

Defining material properties

The material dialog is immediately available when you start a new project or when you open an existing one. The material dialog is organized into separate panels; Concrete, Concrete age, Steel etc.

- For each panel on the dialog enter the material data as shown in the following images.

Concrete Material Properties

Concrete slab	Concrete age
Strength f_{ck} (N/mm ²)	At onset of drying shrinkage t_s (day)
Strength $f_{ct,ef}$ (N/mm ²)	At time considered t (day)
Partial factor γ_c	When perm. load is applied to (day)
Cement class	When shrink. load is applied to (day)
Aggregate type	When imposed d. are applied to (day)
Coeff. of thermal expansion	Permanent creep multiplier PsiL
Max. crack width w_k (mm)	Shrinkage creep multiplier PsiL
	Deformations creep multiplier PsiL

Part 1: Enter section and material data in Steel and Composite Deck Designer (PontiEC4)

Modular ratios <input checked="" type="radio"/> Automatic calculation <input type="radio"/> Direct input n0 <input type="text" value="0"/> nL permanent loads <input type="text" value="0"/> nL shrinkage <input type="text" value="0"/> nL imposed deformation <input type="text" value="0"/>	Environment Exposed area (mm ²) <input type="text" value="925000"/> Exposed perimeter (mm) <input type="text" value="7400"/> Relative humidity (%) <input type="text" value="70"/>
Imposed strain in the slab <input checked="" type="radio"/> Automatic calculation <input type="radio"/> Direct input Shrinkage Deformation <input type="text" value="0"/> Shrinkage comb. factor <input type="text" value="0"/> Temperature difference (°C) <input type="text" value="10"/> Temperature comb. factor <input type="text" value="0"/>	Shear connection Ultimate strength fu (N/mm ²) <input type="text" value="450"/> <i>Reference values for fatigue strength at 2E6 cycles</i> shear stress $\Delta\tau_c$ (N/mm ²) <input type="text" value="90"/> normal stress $\Delta\sigma_c$ (N/mm ²) <input type="text" value="80"/> <i>Partial factors:</i> γ_v <input type="text" value="1.25"/> ks (SLS) <input type="text" value="0.75"/> γ_{ff} <input type="text" value="1"/> $\gamma_{Mf,s}$ <input type="text" value="1"/>



Note. The Steel and Composite Deck Designer (**PontiEC4**) help system contains commentary relating to the information being entered including references to the Eurocode in question.

Steel Material Properties

With the Materials dialog still selected, set the following data for the steel properties:

Composite Highway Bridge Design

Steel

Modulus of elasticity (N/mm²) Poisson's ratio ν

.. structural steel		.. reinforcement steel	
Grade	<input type="text" value="EN 10025-2 S355"/> ?	f_{yk} (N/mm ²)	<input type="text" value="500"/>
	≤ 40 mm > 40 mm	<i>Fatigue strength:</i>	
f_u (N/mm ²)	<input type="text" value="510"/> <input type="text" value="470"/>	$\Delta\sigma_{Rsk}$ (N/mm ²)	<input type="text" value="162.50"/>
f_y (N/mm ²)	<input type="text" value="355"/> <input type="text" value="335"/>	<i>Partial factors:</i>	
<i>Partial factors:</i>		γ_s	<input type="text" value="1.15"/>
γ_{M0}	<input type="text" value="1"/>	γ_F	<input type="text" value="1"/>
γ_{M1}	<input type="text" value="1.1"/>	γ_{Mf}	<input type="text" value="1.15"/>
γ_{Mser}	<input type="text" value="1"/>		
	γ_{Mf}		<input type="text" value="1.35"/> ?

- Click on the Question mark button next to the Grade field, to define a Steel grade of **EN 10025-2 S355**.

Fatigue

FATIGUE. Damage equivalent factors

	STRUCTURAL STEEL	SHEAR STUDS	REINFORC. BARS
-for damage effects induced by the traffic	λ_1 <input type="text" value="(*)"/>	$\lambda_{v,1}$ <input type="text" value="1.000"/>	$\lambda_{s,1}$ <input type="text" value="(*)"/>
-for the traffic composition	λ_2 <input type="text" value="0.848"/>	$\lambda_{v,2}$ <input type="text" value="0.896"/> ?	$\lambda_{s,2}$ <input type="text" value="3.724"/>
-for design life of the structure	λ_3 <input type="text" value="1.000"/>	$\lambda_{v,3}$ <input type="text" value="1.000"/> ?	$\lambda_{s,3}$ <input type="text" value="1.000"/>
-for effects of the heavy traffic on the other slow lanes	λ_4 <input type="text" value="1.000"/>	$\lambda_{v,4}$ <input type="text" value="1.000"/>	$\lambda_{s,4}$ <input type="text" value="1.000"/>
			ϕ_{Fat} <input type="text" value="1.000"/>

(*) Values depending on the section position (input in the -Geometry- dialog window)

For the fatigue factors:-

- λ_2 can be calculated with data input in the window dialog that appears when you click on the Question mark button next to the $\lambda_{v,2}$ input field. Select **Traffic**

Part 1: Enter section and material data in Steel and Composite Deck Designer (PontiEC4)

category 2 and the heavy vehicle distribution to **Medium distance** and select OK to return to the main dialog.

- λ_3 can be calculated with data input in the window dialog that appears when you click on the Question mark button  next to the $\lambda_{v,3}$ input field. Set the design life of the bridge as **100 years** and select OK to return to the main dialog.
- Enter the other factors as shown on the dialog above.

Save the data entered

- Select the **File> Save** menu item to save the PontiEC4 dialog data to the current working project folder.

Defining Geometric properties

Prior to defining the geometric section properties for the spans, the span lengths and the effective concrete slab width (b_{eff}) of each section, defined at various distances along the section, need to be stated.

Defining shear lag slab and flanges

- To input data for the effective slab width calculation, select the **Utilities> Shear lag slab and flanges** menu item.
- Input an array of the bridge spans (the span lengths) in the text box in the top right corner: **28.0, 28.0** and click on the  button. The X distance where the effective slab width changes will be automatically set up in the table.
- For each row input the flange widths $b1^*$, $b2^*$, $b0$ as **1850, 1850, 400** respectively.



Note. Values in the table can be selected and copied and pasted into other cells by using the context menu.

- In the **Type** column ensure that the code **0** is used for the first and last section, **1** for the sagging regions, and **2** for the hogging regions over supports.
- Click the **Calculate** button to calculate b_{eff}

Composite Highway Bridge Design

Data for shear lag of concrete and steel flanges (EN1994-2 5.4.1.2, EN 1993-1-5 3.2.1)

Key:

- 1 $L_e = 0,85 L_1$ for $b_{eff,1}$
- 2 $L_e = 0,25(L_1 + L_2)$ for $b_{eff,2}$
- 3 $L_e = 0,70 L_2$ for $b_{eff,1}$
- 4 $L_e = 2 L_3$ for $b_{eff,2}$

X (m)	b1* (mm)	b2* (mm)	b0 (mm)	Type	b _{eff} (mm)	L _e (m)	b _{eff,1} (mm)	b _{eff,2} (mm)	beta1	beta2
0	1850	1850	400	0	3,405	23,80	1,650	1,650	0,911	0,911
7	1850	1850	400	1	3,700	23,80	1,650	1,650	1,000	1,000
21	1850	1850	400	1	3,700	23,80	1,650	1,650	1,000	1,000
28	1850	1850	400	2	3,700	14,00	1,650	1,650	1,000	1,000
35	1850	1850	400	1	3,700	23,80	1,650	1,650	1,000	1,000
49	1850	1850	400	1	3,700	23,80	1,650	1,650	1,000	1,000
56	1850	1850	400	0	3,405	23,80	1,650	1,650	0,911	0,911

Calculate Exit

- Click the **Exit** button to close the dialog and return to the material dialog



- **Note.** Values of effective length L_e are used to calculate the effective width due to shear lag effects in the slab and the steel flanges. Also once calculated, the numbers are shown with a comma as the thousand separator, so that 1850 becomes 1,850.

Defining geometric data for the bridge

The geometric data for sections along the bridge now needs to be defined. Note at this stage it is not necessary to define all the sections in each segment that will be checked; it will be enough to define just one section for each segment, and input a distance to automatically obtain the corresponding effective width of slab from the shear lag slab table previously defined.

To establish the initial section locations some thought needs to be given to the analysis model that will be used.

Analysis model concept layout

The bridge is to be analysed using the planar grillage analogy with thick beam elements. Although grillage analysis is not the most rigorous analysis type, and is unlikely to model the effects of bracing correctly, the ability to obtain simple results from beam elements with composite sections (transformed section properties), means that it is still widely used for bridge analysis.

The basic girder layout is shown below including splice and bracing locations.

So, for the basic geometric sections in the grillage, only four sections will be used: Span Girder A, Span Girder B and Pier Girder (cracked and uncracked) as shown on the following image:

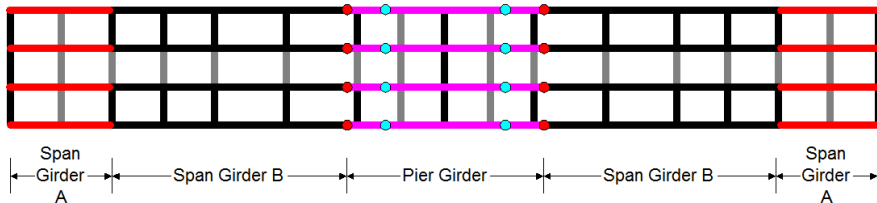

Defining geometric data for Span Girder A

The geometric data for each segment and/or section along the bridge now needs to be defined, starting with Span Girder A.



Note. A girder may be formed / analysed from any number of **Segments** (a length of girder over which all parameters - apart from the total height of steel section and the attributed concrete slab width - remain constant) that are labelled such as Span Girder A, Span Girder B, etc. **Sections** are locations defined within a segment at which geometric properties are defined or calculated. Both terms are used throughout this example.

Segment name, sections, X-distances

- From the main menu select **Windows> 2 Geometry** to display the Geometry dialog.
- In the Segment name panel enter the following:

The screenshot shows the Geometry dialog box. The Segment name panel has 'Span Girder A' entered. The Sections panel has 'Abut' and '0' entered. The dialog box is titled 'Geometry' and has a 'Segment name' label and a 'Sections (eg. Sec1, Sect2...) X (m) (es. X1, X2,...)' label. The 'Abut' and '0' are entered in the 'Sections' field.

Steel section sizes

In the Structural steel panel enter the following:

Part 1: Enter section and material data in Steel and Composite Deck Designer (PontiEC4)

Structural steel (Span Girder A)

bs (mm) 500 Top flange in Class 1

ts (mm) 25 Top flange < 40mm

hmet (mm) 1100

twr (mm) 12

alpha 0 Inclined web

bi (mm) 500

ti (mm) 50 Bottom flange < 40mm

Advanced options for flanges

Edit options

Edit options

- Make sure that **Top flange in Class 1** (no local buckling because attached to the concrete slab) is checked (ticked)
- Make sure that **Top Flange ≤ 40 mm** is checked (ticked)



Note. The checkboxes for Top / Bottom flange ≤ 40 mm are only required to be checked if the flanges have total thickness greater than 40mm but are formed from multiple plates each of a thickness less than 40mm. When checked (ticked), ultimate and yielding tension for steel less than or equal to 40mm thickness will be used.

Vertical web stiffener distance

- In the Vertical stiffeners panel enter the following:

Vertical stiffeners (Span Girder A)

Distance between stiffeners (mm) 7000

Rigid end post EN 1993-1-5, 5.2(2)

Edit options



Note. A vertical stiffeners check is optional and is not carried out in the example. Specifying the distance between vertical stiffeners is the only mandatory value in this panel.

Slab concrete

- In the Slab concrete panel, **right-click inside the bcls field** and select **Calculate beff**. The width of slab will be computed using data previously defined in the shear lag table. Input other data as shown in the following image.

Slab concrete (Span Girder A)

bcls (mm) 3405 tcsls (mm) 250

b1 (mm) 500 bsx (mm) 1702.5

hcop (mm) 50 Consider haunch

For this example, the section properties of the concrete haunch will be ignored in any calculations that are made, so it is left un-checked.

Reinforcing bars

- In the reinforcing bars panel enter the following:

Reinforcing bars (Span Girder A)			
	bar diameter (mm)	bar spacing (mm)	bar cover (mm)
top layer	16	150	55
bottom layer	16	150	60

Shear connection

- In the Shear connection panel enter the following:

Shear connection (Span Girder A)			
n (n ² /m)	21	diameter (mm)	19
		height (mm)	150
Just class 1 and 2 sections in the plastic zones			
Distance elastic-plastic section for ULS-min.	L (m)	0	
Resulting compression in the concrete slab, at L from current section, for ULS M-min.	F _x (N)	0.000E+000	



Note. The values for ‘Distance elastic-plastic section for ULS-min’ and ‘Resulting compression in the concrete slab, at L from current section for ULS M-min’ cannot be determined this early in the design process and are therefore defined as zero for now. These values must be revisited after the bridge has been analysed and design calculations performed.

Fatigue data

- In the Fatigue panel enter the following:

Fatigue (Span Girder A)			
Damage equivalent factor (traffic)	Steel (Bending)	λ_1	2.370
	Steel (Shear)	λ_1	2.538
	Bars	$\lambda_{s,1}$	1.100
Traffic loading factor (Reinforcing bars)		0.000	
Detail categories data (Span Girder A)			

- λ_1 can be calculated automatically by clicking the Question mark button  next to the input field and then, on the Damage equivalent factor dialog, selecting the radio button for the **midspan section** and entering **28.0** for the Span length for moments and **11.2** for the Span length for shears

Part 1: Enter section and material data in Steel and Composite Deck Designer (PontiEC4)

Damage equivalent factor LAMDA1 for road bridge

Figure 9.7: Location of midspan or support

λ_1 , 9.5.2 (2) EN 1993-2, 2006(E)

			Bending moment	Shear force
at midspan		$2.55 - 0.7 (L-10) / 70$	L = length of span under consideration	L = 0.4 * span under consideration
at support	L < 30 m	$2.00 - 0.3 (L-10) / 20$	L = the mean of two adjacent spans	L = length of span under consideration
	L ≥ 30 m	$1.70 + 0.5 (L-30) / 50$		

Span length for moments (m) $\lambda_1 = 2.37$
 Span length for shears (m) $\lambda_1 = 2.538$

Detail categories

- In the Fatigue data panel, select the **Detail categories data** button and define the following data:

Data for fatigue verification of structural part (Span Girder A)

Top flange
 $\Delta\sigma_R$ (N/mm²) Table 8.1: Plain members and mechanically fastened joints (EN 1993-1-9)

Bottom flange
 $\Delta\sigma_R$ (N/mm²) Table 8.1: Plain members and mechanically fastened joints (EN 1993-1-9)

Web
 $\Delta\tau_R$ (N/mm²) Table 8.1: Plain members and mechanically fastened joints (EN 1993-1-9)

Top flange joint
 $\Delta\sigma_R$ (N/mm²) t1 (mm) t2 (mm) e (mm) Table 8.3: Transverse butt welds (EN 1993-1-9)

Bottom flange joint
 $\Delta\sigma_R$ (N/mm²) t1 (mm) t2 (mm) e (mm) Table 8.3: Transverse butt welds (EN 1993-1-9)

Web-Top flange
 $\Delta\sigma_R$ (N/mm²) Table 8.2: Welded built-up sections (EN 1993-1-9)

Web-Bottom flange
 $\Delta\sigma_R$ (N/mm²) Table 8.2: Welded built-up sections (EN 1993-1-9)

Vertical stiffener-Web
 $\Delta\sigma_R$ (N/mm²) Table 8.4: Weld attachments and stiffeners (EN 1993-1-9)

Vertical stiffener-Top flange
 $\Delta\sigma_R$ (N/mm²) Table 8.4: Weld attachments and stiffeners (EN 1993-1-9)

Vertical stiffener-Bottom flange
 $\Delta\sigma_R$ (N/mm²) Table 8.4: Weld attachments and stiffeners (EN 1993-1-9)

Horizontal stiffener-Web
 $\Delta\sigma_R$ (N/mm²) Table 8.4: Weld attachments and stiffeners (EN 1993-1-9)

No value is required for Horizontal stiffener-Web

Adding data for Span Girder A to the segment treeview

- Click on the **Add to list** button located under the segment treeview to save all the data entered for Span Girder A.
- Before entering data for other segments, in the segment treeview **double-click** on the name of the Span Girder A. All data previously input for the previous section is now available for use in defining the next section.



Note. Double-clicking on a segment name in the Segment treeview panel will switch PontiEC4 from EDIT MODE to INPUT MODE. The status bar at the bottom-left of the screen will always show what mode is being used at any time.

Defining geometry for Span Girder B

With the status bar stating 'INPUT GEOMETRY:'

- In the Segment name field delete **Span Girder A** and type **Span Girder B**.
- Change the Section name to **Middle** and Distance **X** to be **14**
- In the Vertical stiffeners panel, set the distance between stiffeners to **8100**
- In the Slab concrete panel, re-calculate the values of bcls and bsx by selecting **Calculate beff** from the context menu for the bcls cell.

Part 1: Enter section and material data in Steel and Composite Deck Designer (PontiEC4)

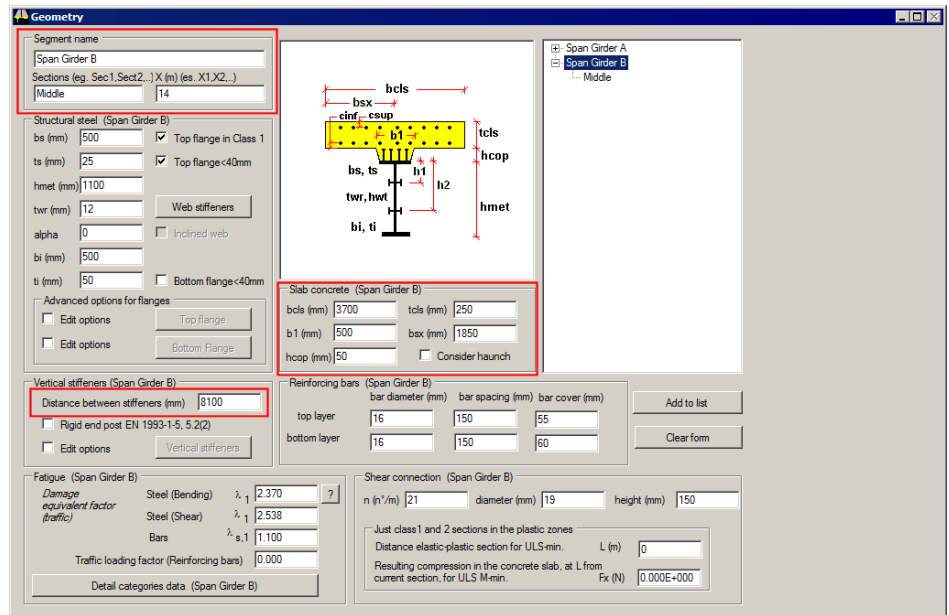

- Click on the **Add to list** button located under the segment treeview to save all the data entered for Span Girder B.
- Before entering data for other segments, in the segment treeview **double-click** on the name of the **Span Girder A**. All data previously input for this section is now available for use in defining the next section.

Defining geometric data for the Pier Girder

- In the Segment name field delete **Span Girder A** and type **Pier Girder**.
- Change the Section name to **Pier** and the Distance **X** to be **28**
- In the Structural steel panel, change the top flange thickness **ts** to **40**
- Change the Web thickness **twr** to **18**
- Change the Bottom flange width **bi** to **650** and thickness **ti** to **60**
- In the Vertical stiffeners panel, set the distance between stiffeners to be **8100**
- In the Slab concrete panel, re-calculate the values of **bcls** and **bsx**. Remember that the values of **bcls** and **bsx** can be calculated automatically by selecting **Calculate beff** from the context menu for both fields.
- In the Reinforcing bars panel, set the top layer reinforcement **bar diameter** to **25** and bottom layer reinforcement **bar diameter** to **25**

Composite Highway Bridge Design

- In the Fatigue panel, λ_1 can be calculated automatically by clicking the Question mark button  next to the input field and then, on the Damage equivalent factor dialog, select the radio button for the **support section** and enter **28** for the Span length for moments and **28** for the Span length for shears

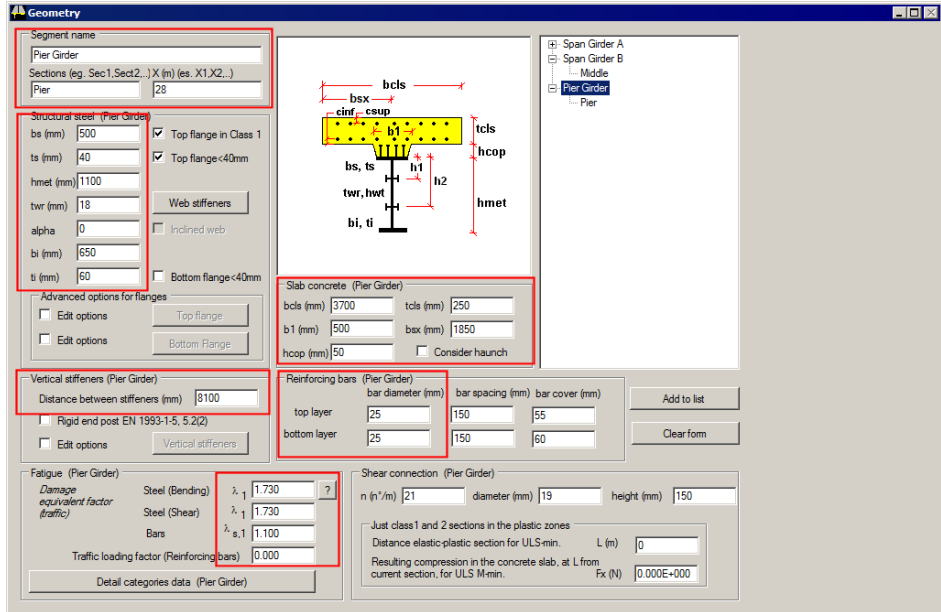

Segment name
 Pier Girder
 Sections (eg. Sect1, Sect2...) X (m) (es. X1, X2...)
 Pier 28

Structural steel (Pier Girder)
 Top flange in Class 1
 Top flange <40mm
 Inclined web
 Bottom flange <40mm
 bs (mm) 500
 ts (mm) 40
 hmet (mm) 1100
 twr (mm) 18
 alpha 0
 bi (mm) 650
 ti (mm) 60

Slab concrete (Pier Girder)
 bcls (mm) 3700 tcls (mm) 250
 b1 (mm) 500 bsx (mm) 1850
 hcop (mm) 50 Consider haunch

Vertical stiffeners (Pier Girder)
 Distance between stiffeners (mm) 8100
 Rigid end post EN 1993-1-5, 5.2(2)
 Edit options

Reinforcing bars (Pier Girder)

	bar diameter (mm)	bar spacing (mm)	bar cover (mm)
top layer	25	150	55
bottom layer	25	150	60

Fatigue (Pier Girder)
 Damage equivalent factor (traffic)
 Steel (Bending) λ_1 1.730 ?
 Steel (Shear) λ_1 1.730
 Bars $\lambda_{s,1}$ 1.100
 Traffic loading factor (Reinforcing bars) 0.000

Shear connection (Pier Girder)
 n (n/m) 21 diameter (mm) 19 height (mm) 150
 Just class 1 and 2 sections in the plastic zones
 Distance elastic-plastic section for ULS-min. L (m) 0
 Resulting compression in the concrete slab, at L from current section, for ULS M-min. Fx (N) 0.000E+000

- Click on the **Add to list** button located under the segment treeview to save all the data entered for the Pier Girder.

Save the entered data

- Select the **File> Save** menu item to save the PontIEC4 dialog data to the current working project folder.

Part 2: Export properties from Steel and Composite Deck Designer PontiEC4 to LUSAS Bridge

Associated Files

These supplied files are only for use in case of problems in manually creating the appropriate data in this section of the example.



- LUSAS_Comp_Bridge.csv** - the input file for PontiEC4 with data on sections and materials.

Prior to exporting geometric properties, the Steel and Composite Deck Designer (PontiEC4) needs to check that all the data that has been input is valid, and then run part of the EC4 code check to calculate the required geometric properties of each defined cross section. This is automatically done when requesting to view the Results window/dialog and should always be done prior to exporting properties subsequently.

- On the main Steel and Composite Deck Designer (PontiEC4) menu select **Window> 4 Results** to set the **Results** dialog active. After a short delay whilst a partial code check is run, the geometric properties of each cross section will be calculated. This can be confirmed by selecting a Cross-section and Design combination with the **Geometric properties 2** tab active.
- When complete, select **File> Export geometric properties to LUSAS**
- On the dialog, browse to your working project folder and enter a filename of “**LUSAS_Sections_Rev0.vbs**”.
- Select (check) all the **Export** check boxes (apart from Export Phase 2c).
- Ensure that the option ‘**Distance middle plane of slab – neutral axis**’ is **not** selected
- Ensure that the option **Assume slab width constant and use minimum value** is selected. Click **OK** to finish.

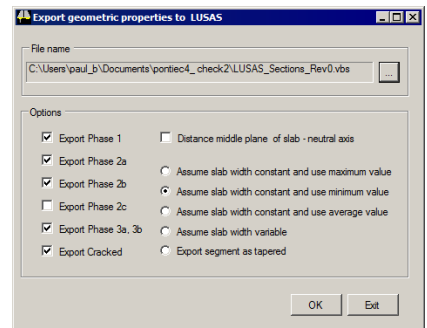

Phases explained

- Phase 1** – Steel sections only, non-composite action. Slab will be considered only as load.

- Phase 2a** - The composite sections with **long term** properties of the concrete. Loadings considered are the **permanent** ones.
- Phase 2b** - The composite sections with **long term** properties of the concrete. Loading considered is the **shrinkage of the concrete**.
- Phase 2c** – this represents the actions arising from prestressing and is therefore not required in this example.
- Phase 3** - The composite sections with **short term** properties of the concrete. Loading considered are the **variable actions**.

Next, the equivalent loading for the shrinkage effects can be exported.

- Select **File> Export equivalent DT to LUSAS**
- Browse to the working project folder and enter a filename of “**LUSAS_Shrinkage.vbs**”.
- Select the **Shrinkage** option and Click **OK** to finish.

Finally, the loading for the temperature effects can be exported.

- Select **File> Export equivalent DT to LUSAS**
- Browse to the working project folder and enter a filename of “**LUSAS_Thermal.vbs**”.
- Select the **Thermal** option and Click **OK** to finish.

Part 3: Building the LUSAS analysis model

Running LUSAS Modeller

For details of how to run LUSAS Modeller, see the heading *Running LUSAS Modeller* in the Examples Manual Introduction.



Note. This example is written assuming a new LUSAS Modeller session has been started. If continuing from an existing Modeller session, select the menu command **File > New** to start a new model file. Modeller will prompt for any unsaved data and display the New Model dialog.

Creating a new model

- Enter the file name as **LUSAS_Comp_Bridge**

- Set the working folder to be the same as that used for the PontiEC4 dialog data.
- Enter the title as **Composite highway bridge design**
- Select units of **N,m,kg,s,C**



Caution. It is important that the units used in the Steel and Composite Deck Designer (**PontiEC4**) are also specified for LUSAS model. If consistent units are not used, the results obtained will be incorrect.

- Leave timescale units as **Seconds**
- Ensure the **Structural** analysis type is selected.
- Set an analysis category of **2D Grillage / Plate**
- Leave the startup template set to **None**
- Select the **Vertical Z Axis** option.
- Click the **OK** button.



Note. Use the Undo button to correct any mistakes made since the last save was done.

Import of section properties

The section properties exported from Steel and Composite Deck Designer (**PontiEC4**) need to be imported into LUSAS

Locate the “**LUSAS_Sections_Rev0.vbs**” and open in LUSAS.

- Select the file **LUSAS_Sections_Rev0.vbs** and click **OK**.

This will populate the Attributes  treeview with the geometric section properties and material properties exported from Steel and Composite Deck Designer (**PontiEC4**) as shown below.

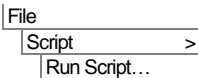

Important. In the final stage of this example the Steel and Composite Deck Designer (**PontiEC4**) inspects the segment names in order to extract properties from the attributes for the design process. In order for this to happen the attribute name needs to be defined in a recognised format. For this reason the cross-section geometric properties in any associated LUSAS model must have a name that follows this standard:

[Segment Name] +”_”+ [Phase name]; where the phase name should be: {F1, F2a, F2b, F3a, F3b, cracked}.

e.g. Span Girder A__F1

Composite Highway Bridge Design

The cracked status of the section is a Boolean value taken as true when the phase name is “cracked”, and false otherwise.

Any sections imported from the Steel and Composite Deck Designer (PontiEC4) will automatically be defined in the correct format.

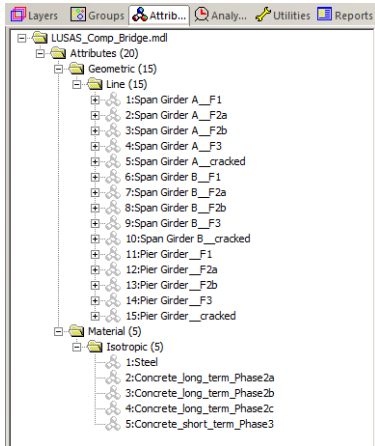

Now that the geometric and material properties have been imported, the analysis model that will use them can be constructed.

As discussed earlier in this example a simple grillage analogy will be used for the analysis model. The grillage wizard could be used but in this example the grillage will be constructed manually based on the layout and dimensions shown below.

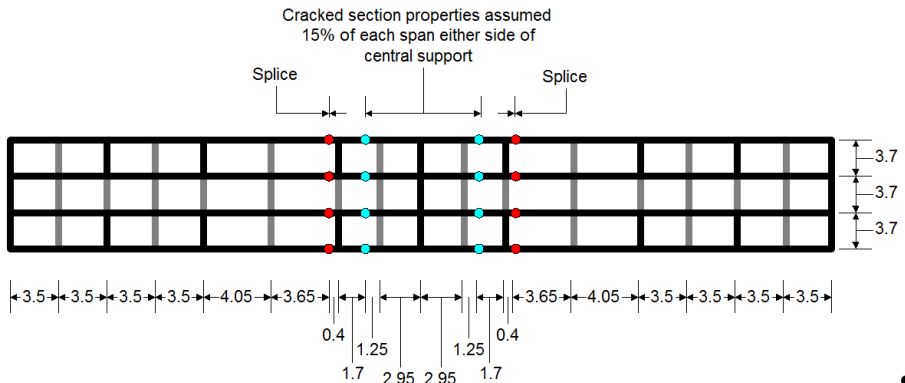

Defining the base geometry

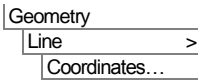

Enter coordinates of **(0, 0)**, and **(3.5, 0)**, to define the first Line of the grillage.

- Select the Line that has just drawn.

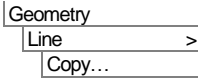

Copy the Line through a translation of **X= 3.5, Y= 0, Z = 0**, set the number of copies to **3** and click **OK** to create further Lines.

- Select the Point at the right hand end of the Line that is furthest to the right.

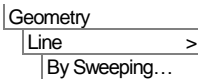

Sweep the Point through a translation of **X= 4.05, Y= 0, Z = 0** and click **OK** to create a Line.

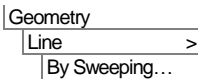

Repeat the process of selecting the Point at the right hand end of the Line that is furthest to the right and sweeping using the following translations:-

X= 3.65, Y= 0, Z = 0

X= 0.4, Y= 0, Z = 0

X= 1.7, Y= 0, Z = 0

X= 1.25, Y= 0, Z = 0

X= 2.95, Y= 0, Z = 0

X= 2.95, Y= 0, Z = 0

X= 1.25, Y= 0, Z = 0

X= 1.7, Y= 0, Z = 0

X= 0.4, Y= 0, Z = 0

X= 3.65, Y= 0, Z = 0

X= 4.05, Y= 0, Z = 0

X= 3.5, Y= 0, Z = 0

- Select the line furthest to the right.

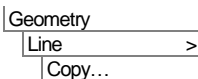

Copy the Line through a translation of **X= 3.5, Y= 0, Z = 0**, set the number of copies to **3** and click **OK** to create further Lines.

Composite Highway Bridge Design

- Select all the Points in the model except the four points that represent the splice locations and where the cracked section properties start – as shown by arrows on the image that follows.



Tip. Select the ‘Select Points’ cursor and use the Shift key to add to each set of selections made.

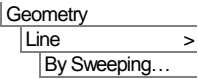
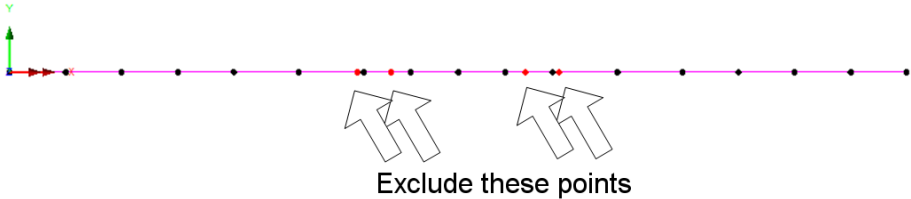

Sweep the selected Points through a translation of $X=0$, $Y=3.7$, $Z=0$ and click **OK** to create Lines.

- Ensure the ‘Select Any’ cursor is back in use.
- Select everything on the screen, all the lines.

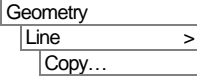



Copy the Lines through a translation of $X=0$, $Y=3.7$, $Z=0$, set the number of copies to 3 and click **OK** to create further Lines.

- Select the additional unwanted Lines shown below.

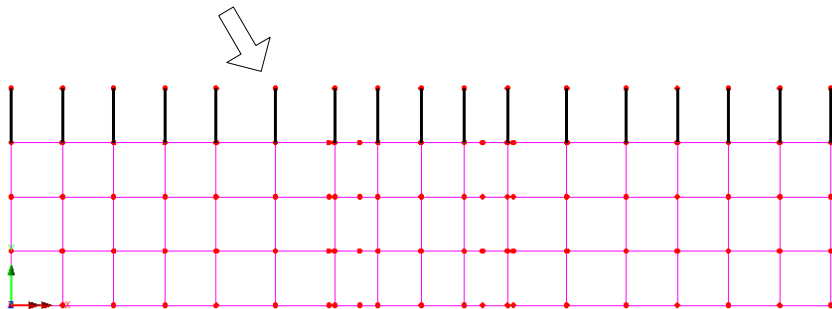

Tip. Hold down the Alt key whilst dragging a selection box through the extent of all the lines.



 Delete the selected Lines, confirming that Lines and Points are to be deleted.

Defining groups

Model features will be grouped together to make assignment of attributes and viewing of model results easier. Lines representing the different geometric sections will be formed into named groups.

Span girder A

- Select the eight lines at each end of the deck which will have **Span Girder A** properties assigned to them.

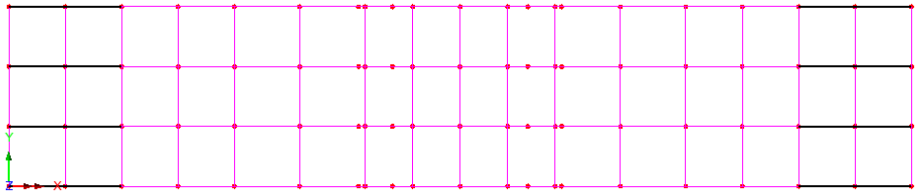

Tip. Select the ‘Select X axis’ cursor and box-select the lines at each end of the deck. Use the Shift key to add to the previous selection made.

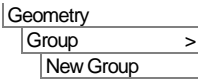

This adds a New Group entry in the  Treeview for the features selected.

- Enter the group name as **Span Girder A** and click **OK** to finish defining the group.

Span girder B

- Next, select the thirty-two lines which will have **Span Girder B** properties assigned to them.

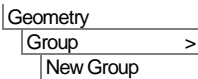
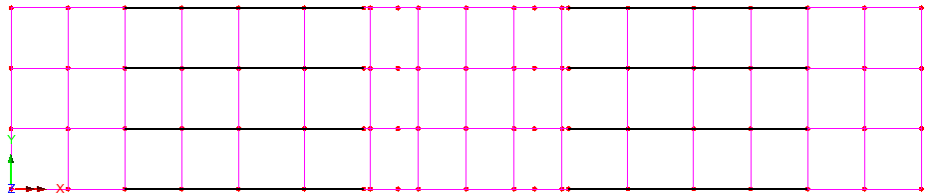

This adds a New Group entry for the features selected.

- Enter the group name as **Span Girder B** and click **OK** to finish defining the group.

Pier girder uncracked region

- Next, select the sixteen lines which will have **Pier Girder Uncracked** properties assigned to them. These are the lines between the splice and the point where the cracked section properties start.

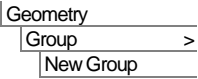
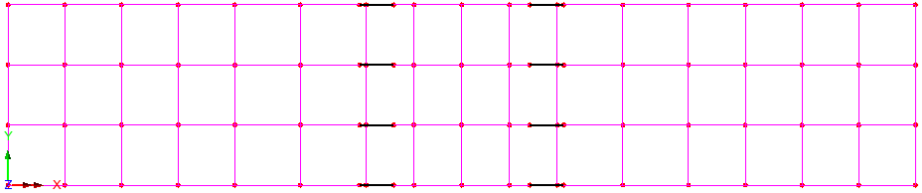

This adds a New Group entry for the features selected.

- Enter the group name as **Pier Girder Uncracked** and click **OK** to finish defining the group.

Pier girder cracked region

- Select the sixteen lines which will have the **Pier Girder Cracked** properties assigned to them.

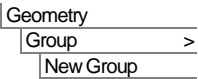
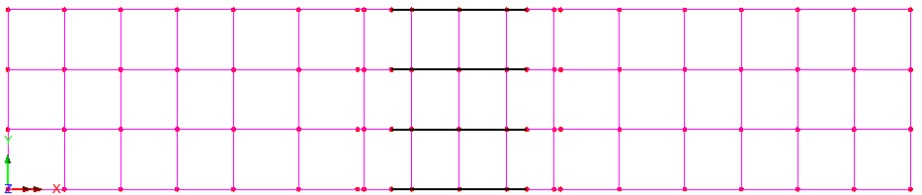

This adds a New Group entry for the features selected.

- Enter the group name as **Pier Girder Cracked** and click **OK** to finish defining the group.

Main girders

- Select all the longitudinal lines.

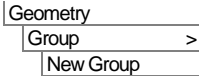
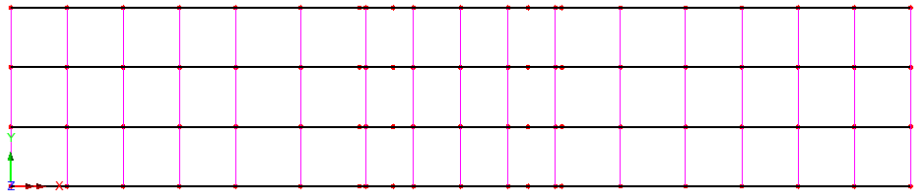

This adds a New Group entry for the features selected.

- Enter the group name as **Main Girders** and click **OK** to finish defining the group.

Transverse slab

- Select all the transverse lines



Tip. Select the 'Select Y axis' cursor and box-select the whole model.

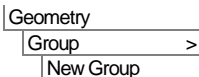
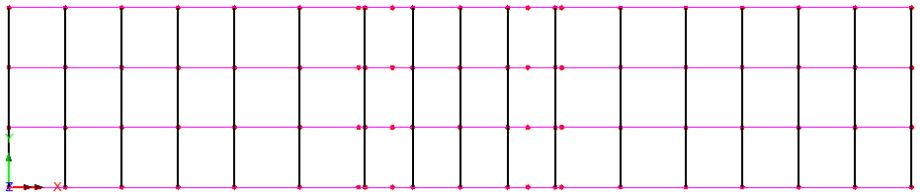

This adds a New Group entry for the features selected.

- Enter the group name as **Transverse Slab** and click **OK** to finish defining the group.
- Ensure the 'Select Any' cursor is back in use.

Construction phases



Note. To carry out the design of the bridge the analysis model will need to have the relevant construction phases (**Phase 1**, **Phase 2a**, **Phase 2b** and **Phase 3**) simulated within the analysis model. Normally the order that these would be listed in the Analyses treeview for the model would mimic the construction process, so **Phase 1** would come before **Phase 2a**. However it is intended to use the **Traffic Load Optimisation** facility with LUSAS to generate the Traffic load patterns for **Phase 3**. This will require influence analysis to be undertaken and currently when running an influence analysis the properties of the base analysis are always considered for the influence analysis. Therefore the base analysis will actually be set with the short term properties that are

used for **Phase 3**. So the actual order that the Phases will be dealt with in this example will be **Phase 3** first, followed by **Phase 2b**, **Phase 2a** and finally **Phase 1**.

Defining and Assigning Mesh Attributes

- The grillage Lines are to be modelled with 3D **Thick Beam**, **Linear** elements (BMI21 elements) with **1** mesh division.
- Enter the attribute name as **Thick Beam** and click **OK**.
- Select all Lines in the model and drag and drop the **Thick Beam** mesh from the  Treeview onto the selected features. Click **OK** to assign.

Defining Geometric Properties

The section properties for the longitudinal members in the grillage have been imported in LUSAS earlier in this example. However the transverse section properties for the slab sections now need to be created.

Only a single transverse section will be defined for this example and this will be used in all locations. This is a simplification as the grillage bays are of different widths and the transverse section should be based on size of grillage bays.



- Ensure that the usage is set to **3D Thick Beam**
- Enter the Cross sectional area (A) = **0.875**, Second moment of area about y axis (Iyy) = **0.004653**, Second moment of area about z axis (Izz) = **0.1667** Torsional constant (J) = **0.00911**, Effective shear area in y direction (Asy) = **0.729** and Effective shear area in z direction (Asz) = **0.729**
- Enter the attribute name as **Transverse Slab** and click **OK**.

Assigning Geometric Properties



As an alternative to selecting features by dragging a box around them, the previously named Groups will be used.



Select the fleshing on/off button to turn-off geometric property visualisation.

- In the  Treeview, click the right-hand mouse button on the group name **Span Girder A** and select the **Select Members** option from the menu. If you already have some features selected click **Yes** to deselect them first.
- From the  Treeview, drag and drop the geometric attribute **Span Girder A_F3** onto the selected Lines.

Repeat this operation for the following assignments:

<ul style="list-style-type: none"> In the  Treeview, select the members of each group, clicking Yes to deselect any existing selection. 	<ul style="list-style-type: none"> From the  Treeview, drag and drop each named geometric attribute  onto the selected lines
<ul style="list-style-type: none"> Span Girder B 	<ul style="list-style-type: none"> Span Girder B__F3
<ul style="list-style-type: none"> Pier Girder Uncracked 	<ul style="list-style-type: none"> Pier Girder__F3
<ul style="list-style-type: none"> Pier Girder Cracked 	<ul style="list-style-type: none"> Pier Girder__Cracked
<ul style="list-style-type: none"> Transverse Slab 	<ul style="list-style-type: none"> Transverse slab

Checking Geometric Assignments

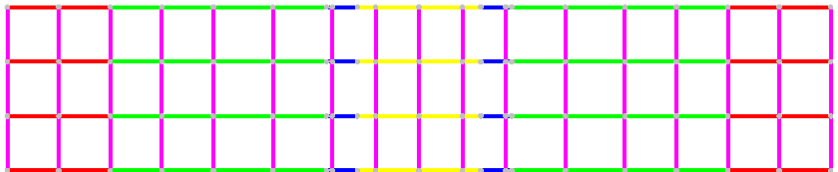
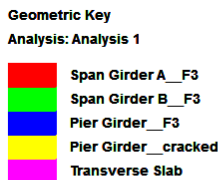

- Double-click on the **Geometry** layer in the  Treeview and select **Assignment** from the Colour by drop down list. Click the **Set** button and select **Geometric** from the Attribute Type drop down list.
- With the **Generate key** option selected click the **OK** button to return to the Geometry properties dialog and **OK** again to display the geometry coloured by geometric assignment with the key annotated.



- To remove the 'Colour by Attribute' assignment double click on **Geometry** in the  Treeview, select **Own Colour** from the Colour by drop down list and click **OK** to update the display.



Defining and Assigning Material Properties

The materials for the grillage have already been imported into LUSAS earlier in this example. These properties now need to be assigned to selected members of the model as follows:

<ul style="list-style-type: none"> In the  Treeview, select the members of each group, clicking Yes to deselect any existing selection. 	<ul style="list-style-type: none"> From the  Treeview, drag and drop each named material attribute  onto the selected lines 	<ul style="list-style-type: none"> Assign to Analysis 	<ul style="list-style-type: none"> Assign to Loadcase
<ul style="list-style-type: none"> Main Girders 	<ul style="list-style-type: none"> Steel 	<ul style="list-style-type: none"> Analysis 1 	<ul style="list-style-type: none"> Loadcase 1
<ul style="list-style-type: none"> Transverse Slab 	<ul style="list-style-type: none"> Concrete_short_term_Phase3 	<ul style="list-style-type: none"> Analysis 1 	<ul style="list-style-type: none"> Loadcase 1

Defining and Assigning Supports

Define supports that set up the correct articulation for the structure. In this example the bridge will have one pinned support, one guided support and the remainder of the supports will be vertical.



- Click on the option **Fixed** for the **Translation in X, Y and Z**.
- Enter the attribute name as **Pinned (X,Y,Z)** and click the **Apply** button to add the attribute to the  Treeview and keep the dialog active.
- Click on the option **Free** for the **Translation in X**.
- Enter the attribute name as **Guide (Y,Z)** and click the **Apply** button to add the attribute to the  Treeview and keep the dialog active.
- Click on the option **Free** for the **Translation in Y**.
- Enter the attribute name as **Vertical (Z)** and click the **OK** button to add the attribute to the  Treeview.

Assign the supports to the model

- Box-select the Points that represent each of bearing locations and drag and drop the support attribute **Vertical (Z)** from the  Treeview onto the selection. With the

Attributes
Support...

Assign to Points option selected click **OK** to assign the support attribute to **Analysis 1** for all Analysis loadcases.

- Select the Point on the left hand side of the grillage on the line representing the second girder and drag and drop the support attribute **Pinned (X,Y,Z)** from the  Treeview onto the selection. With the **Assign to Points** option selected click **OK** to assign the support attribute to **Analysis 1** for all Analysis loadcases. This will replace the previous support assignment.
- Select the Point on the right hand side of the grillage on the line representing the second girder and drag and drop the support attribute **Guide (Y,Z)** from the  Treeview onto the selection. With the **Assign to Points** option selected click **OK** to assign the support attribute to **Analysis 1** for all Analysis loadcases. This will replace the previous support assignment.



Note. Only one support can be assigned to a point in one loadcase.

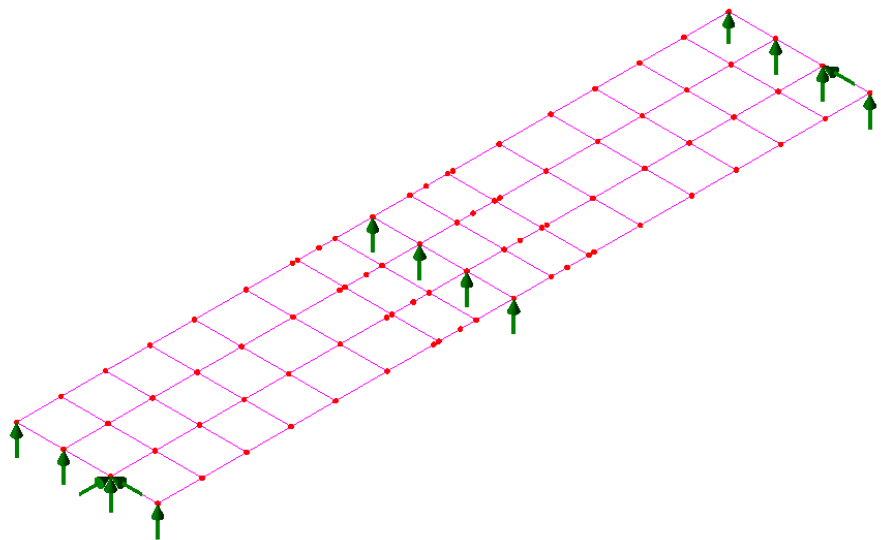

Defining and Assigning Loading

In the first analysis, variable actions will be considered. Thermal effects are variable actions that will be applied to the analysis.



Note. In this example it is going to be assumed that the simplified approach to the thermal loading can be used. However it should be noted that in BS EN 1991-1-5, 6.1.2(2) it is stated that this simplified approach should only be used if it is agreed for

Composite Highway Bridge Design

the individual project with the relevant authority. Otherwise an approach using a nonlinear thermal profile should be adopted.

Earlier in the example the Thermal effects were exported from the Composite Deck Designer (**PontiEC4**) into a file called “**LUSAS_Thermal.vbs**”.

Locate the “**LUSAS_Thermal.vbs**” and open in LUSAS.



- Select the file **LUSAS_Thermal.vbs** and press OK to open in LUSAS.

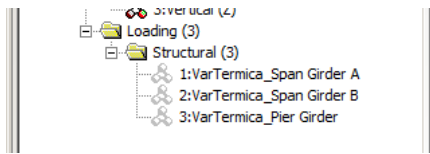

This adds some thermal load attributes to the Attributes  treeview as shown:



- These attributes are to be renamed. Right-click on each in turn and rename the label **VarTermica** to be **Thermal**.



Assigning thermal loading

- In the Groups  Treeview, click the right-hand mouse button on the group name **Span Girder A** and select the **Select Members** option from the menu. If you already have some features selected click **Yes** to deselect them first.
- From the Attributes  Treeview, drag and drop the load attribute **Thermal_Span Girder A** onto the selected Lines. Make sure that the analysis option is set to **Analysis 1** and the loadcase option is set **Loadcase 1** to assign the properties into the first analysis.
- Repeat these operations to make the following assignments:



<ul style="list-style-type: none"> • In the  Treeview, Select Members of each group, clicking Yes to deselect any existing selection. 	<ul style="list-style-type: none"> • From the  Treeview, drag and drop each named loading attribute  onto the selected lines 	<ul style="list-style-type: none"> • Assign to Analysis 	<ul style="list-style-type: none"> • Assign to Loadcase
<ul style="list-style-type: none"> • Span Girder B 	<ul style="list-style-type: none"> • Thermal_Span Girder B 	<ul style="list-style-type: none"> • Analysis 1 	<ul style="list-style-type: none"> • Loadcase 1
<ul style="list-style-type: none"> • Pier Girder Uncracked 	<ul style="list-style-type: none"> • Thermal_Pier Girder 	<ul style="list-style-type: none"> • Analysis 1 	<ul style="list-style-type: none"> • Loadcase 1



• Pier Girder Cracked	• Thermal_Pier Girder	• Analysis 1	• Loadcase 1
-----------------------	-----------------------	--------------	--------------

Rename analysis 1

- In the Analyses  treeview, right-click on **Analysis 1** and rename as **Analysis 1 Phase 3 Composite Variable Actions**
- In the  treeview, right-click on **Loadcase 1** in Analysis 1 and rename as **Thermal heat**.

Assigning Thermal Loading for Cooling Case

- In the Groups  Treeview, click the right-hand mouse button on the group name **Span Girder A** and select the **Select Members** option from the menu. If you already have some features selected click **Yes** to deselect them first.
- From the Attributes  Treeview, drag and drop the load attribute **Thermal_Span Girder A** onto the selected Lines. Make sure that the analysis option is set to **Analysis 1**. Then, using the loadcase select, select **New** from the drop-down list, and enter the name **Thermal cool**. Click **OK**. Then click the **More** button and enter the load factor as **-1**.
- Repeat these operations to make the following assignments:

• In the  Treeview, Select Members of each group, clicking Yes to deselect any existing selection.	• From the  Treeview, drag and drop each named loading attribute  onto the selected lines	• Assign to Analysis	• Assign to loadcase • With a load factor of
• Span Girder B	• Thermal_Span Girder B	• Analysis 1	• Thermal cool • -1
• Pier Girder Uncracked	• Thermal_Pier Girder	• Analysis 1	• Thermal cool • -1
• Pier Girder	• Thermal_Pier	• Analysis 1	• Thermal

Cracked	Girder		cool • -1
---------	--------	--	--------------

Save the model



Save the model file.

File
Save



Tip. Before creating the other analyses or further loadcases it is good practice to check that Analysis 1 will solve without errors.

Check the model will solve



Click the **Solve now** button and press **OK** to run the analysis using LUSAS Solver and load the results file. The deformed mesh plot for Analysis 1, loadcase Thermal cool is shown below.

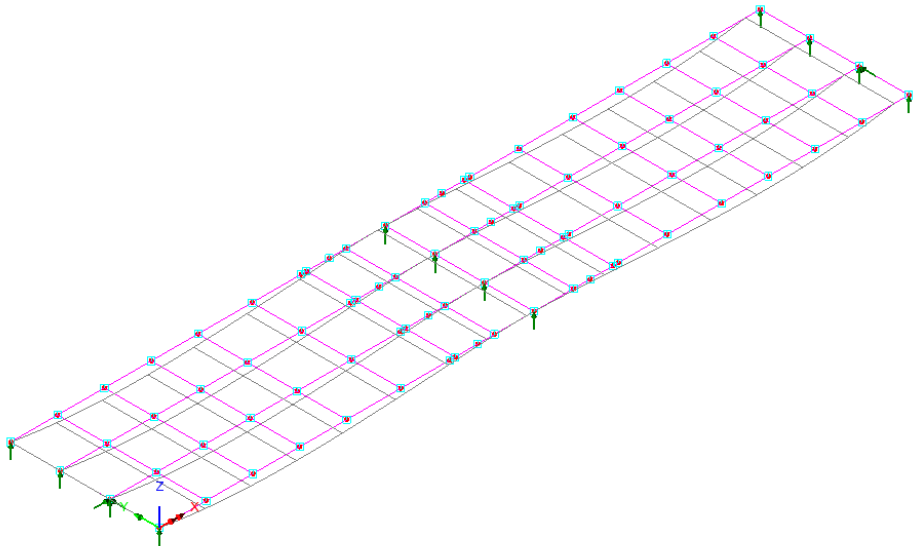

Once Analysis 1 has been checked to ensure that it solves without errors, the additional analyses and phases required for the design process can be added.

Analyses
Structural
Analysis...

Defining Analysis 2 Settlement and Shrinkage Loads



- Ensure that the option **Inherit from the base analysis (All)** is checked (ticked).
- Enter the analysis name as **Analysis 2 Phase 2b Composite Settlement/Shrinkage**, then press **OK**.

This will create a second analysis that has the same engineering properties (geometric sections, materials properties and supports) as the base analysis, **Analysis 1 Phase 3 Composite Variable Actions**.

- In the Analyses  treeview, right-click on **Loadcase 2** in Analysis 2 and rename as **Settlement**.



Assigning Geometric Properties in Analysis 2

Currently Analysis 2 has inherited the section properties from Analysis 1. These need to be changed as follows:

<ul style="list-style-type: none"> • In the  Treeview, Select Members of each group, clicking Yes to deselect any existing selection. 	<ul style="list-style-type: none"> • From the  Treeview, drag and drop each named geometric attribute  onto the selected lines 	<ul style="list-style-type: none"> • Assign to Analysis
<ul style="list-style-type: none"> • Span Girder A 	<ul style="list-style-type: none"> • Span Girder A__F2b 	<ul style="list-style-type: none"> • Analysis 2 Phase 2b Composite Settlement/Shrinkage
<ul style="list-style-type: none"> • Span Girder B 	<ul style="list-style-type: none"> • Span Girder B__F2b 	<ul style="list-style-type: none"> • Analysis 2 Phase 2b Composite Settlement/Shrinkage
<ul style="list-style-type: none"> • Pier Girder Uncracked 	<ul style="list-style-type: none"> • Pier Girder__F2b 	<ul style="list-style-type: none"> • Analysis 2 Phase 2b Composite Settlement/Shrinkage

Defining and Assigning Material Properties in Analysis 2

The transverse slab geometric section properties have been inherited from the base analysis but it has also inherited the base material **Concrete_short_term_Phase3**. This needs to be changed for analysis 2.

- In the  Treeview, click the right-hand mouse button on the group name **Transverse Slab** and select the **Select Members** option from the menu. If you already have some features selected click **Yes** to deselect them first.
- From the  Treeview, drag and drop the material attribute **Concrete_long_term_Phase2b** onto the selected Lines. Make sure that the analysis option is set to **Analysis 2 Phase 2b Composite Settlement/Shrinkage** to assign the properties into the second analysis.

Defining and Assigning Loading in Analysis 2

In the second analysis the settlement and shrinkage loads will be applied to the analysis model.

A settlement of 10mm will be considered at the internal pier.

- Select the **Prescribed Displacement** option and click **Next**.
- Set the translation in the **Z** direction to **Fixed**, the displacement as **Total, -0.01m**.
- Enter an attribute name of **Settlement 10mm** and click **OK**.
- Select the four points at the internal pier location that have supports assigned to them.
- From the  Treeview, drag and drop the point loading attribute **Settlement 10mm** onto the selected Points. Make sure that the load is applied into **Analysis 2 Phase 2b Composite Settlement/Shrinkage** and the loadcase **Settlement**.

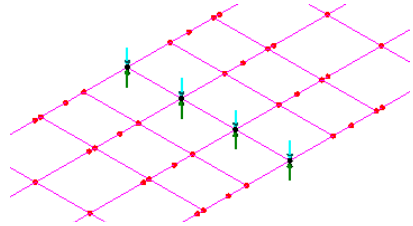

Next, the effects of shrinkage can be applied to the analysis. Earlier in the example the shrinkage effects were exported from the Composite Deck Designer (**PontiEC4**) into a file called “**LUSAS_Shrinkage.vbs**”.

Locate the “**LUSAS_Shrinkage.vbs**” and open in LUSAS.

- Select the file **LUSAS_Shrinkage.vbs** and press OK to open in LUSAS.



This adds some shrinkage load attributes to the Attributes  Treeview as shown:

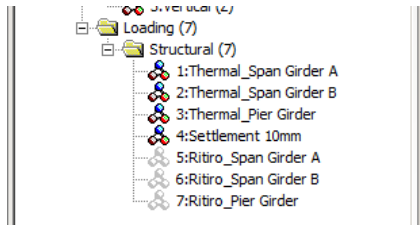

Attributes
Loading...

File
Script >
Run Script...



These attributes are to be renamed.

- Right-click on each in turn and rename the label **Ritiro** with the word **Shrinkage**.
- In the  Treeview, click the right-hand mouse button on the group name **Span Girder A** and select the **Select Members** option from the menu. If you already have some features selected click **Yes** to deselect them first.
- Drag and drop the loading attribute **Shrinkage_Span Girder A** from the  Treeview onto the selected Lines. Make sure that the analysis option is set to **Analysis 2 Phase 2b Composite Settlement/Shrinkage** to assign the properties into the second analysis. Using the loadcase select, select **New** from the drop-down list, and enter the name **Shrinkage**. Click **OK**.
- Repeat these operations to make the following assignments:

<ul style="list-style-type: none"> • In the  Treeview, Select Members of each group, clicking Yes to deselect any existing selection. 	<ul style="list-style-type: none"> • From the  Treeview, drag and drop each named loading attribute  onto the selected lines 	<ul style="list-style-type: none"> • Assign to Analysis 	<ul style="list-style-type: none"> • Assign to Loadcase
<ul style="list-style-type: none"> • Span Girder B 	<ul style="list-style-type: none"> • Shrinkage_Span Girder B 	<ul style="list-style-type: none"> • Analysis 2 Phase 2b Composite Settlement/Shrinkage 	<ul style="list-style-type: none"> • Shrinkage
<ul style="list-style-type: none"> • Pier Girder Uncracked 	<ul style="list-style-type: none"> • Shrinkage_Pier Girder 	<ul style="list-style-type: none"> • Analysis 2 Phase 2b Composite Settlement/Shrinkage 	<ul style="list-style-type: none"> • Shrinkage
<ul style="list-style-type: none"> • Pier Girder 	<ul style="list-style-type: none"> • Shrinkage_Pier 	<ul style="list-style-type: none"> • Analysis 2 Phase 2b 	<ul style="list-style-type: none"> • Shrinkage

Cracked	Girder	Composite Settlement/ Shrinkage	
---------	--------	------------------------------------	--



Defining Analysis 3 Permanent Loads

Analyses
Structural
Analysis...

- Ensure that the option **Inherit from the base analysis (All)** is checked (ticked).
- Enter the analysis name as **Analysis 3 Phase 2a Composite Permanent**, then press **OK**.
- In the Analyses  treeview, right-click on **Loadcase 2** in Analysis 3 and rename as **Surfacing**.



Assigning Geometric Properties in Analysis 3

Currently Analysis 3 has inherited the section properties from Analysis 1. These need to be changed as follows:

<ul style="list-style-type: none"> • In the  Treeview, Select Members of each group, clicking Yes to deselect any existing selection. 	<ul style="list-style-type: none"> • From the  Treeview, drag and drop each named geometric attribute  onto the selected lines 	<ul style="list-style-type: none"> • Assign to Analysis
<ul style="list-style-type: none"> • Span Girder A 	<ul style="list-style-type: none"> • Span Girder A__F2a 	<ul style="list-style-type: none"> • Analysis 3 Phase 2a Composite Permanent
<ul style="list-style-type: none"> • Span Girder B 	<ul style="list-style-type: none"> • Span Girder B__F2a 	<ul style="list-style-type: none"> • Analysis 3 Phase 2a Composite Permanent
<ul style="list-style-type: none"> • Pier Girder Uncracked 	<ul style="list-style-type: none"> • Pier Girder__F2a 	<ul style="list-style-type: none"> • Analysis 3 Phase 2a Composite Permanent



Defining and Assigning Material Properties in Analysis 3

The transverse slab geometric section properties have been inherited from the base analysis but it has also in inherited the base material **Concrete_short_term_Phase3**. This needs to be changed for analysis 3.

- In the Groups  Treeview, click the right-hand mouse button on the group name **Transverse Slab** and select the **Select Members** option from the menu. If you already have some features selected click **Yes** to deselect them first.
- Drag and drop the material attribute **Concrete_long_term_Phase2a** from the Attributes  Treeview onto the selected Lines. Make sure that the analysis option is set to **Analysis 3 Phase 2a Composite Permanent** to assign the properties into the third analysis. Click **OK**.

Defining and Assigning Loading in Analysis 3

In the third analysis the permanent loads due to surfacing will be applied on the main girders.



- Select the **Global distributed** option and click **Next**.
- Set the type to **Per unit length**, the Z direction as **-8700 N/m**.
- Enter an attribute name of **Weight of Surfacing** and click **Finish**.
- In the  Treeview, click the right-hand mouse button on the group name **Main Girders** and select the **Select Members** option from the menu. If you already have some features selected click **Yes** to deselect them first.
- From the  Treeview, drag and drop the loading attribute **Weight of Surfacing** onto the selected Lines. Make sure that the load is applied into **Analysis 3 Phase 2a Composite Permanent** and the loadcase **Surfacing**.

Defining Analysis 4 Permanent Loads

- Ensure that the option **Inherit from the base analysis (All)** is checked (ticked).
- Enter the analysis name as **Analysis 4 Phase 1 Non-Composite Self Weight**, then press **OK**.
- In the Analyses  treeview, right-click on **Loadcase 1** in Analysis 4 and rename as **Steel Self Weight**.

Assigning Geometric Properties in Analysis 4

Currently Analysis 4 has inherited the section properties form Analysis 1. These need to be changed as follows:



<ul style="list-style-type: none"> • In the  Treeview, Select Members of each 	<ul style="list-style-type: none"> • From the  Treeview, drag and drop each named geometric material 	<ul style="list-style-type: none"> • Assign to Analysis
---	--	--

group, clicking Yes to deselect any existing selection.	attribute  onto the selected lines	
• Span Girder A	• Span Girder A__F1	• Analysis 4 Phase 1 Non-Composite Self Weight
• Span Girder B	• Span Girder B__F1	• Analysis 4 Phase 1 Non-Composite Self Weight
• Pier Girder Uncracked	• Pier Girder__F1	• Analysis 4 Phase 1 Non-Composite Self Weight
• Pier Girder Cracked	• Pier Girder__F1	• Analysis 4 Phase 1 Non-Composite Self Weight

Defining and Assigning Deactivation dataset in Analysis 4

Currently the **Transverse Slab** has the material properties of **Concrete_short_term_Phase3** which have been inherited from the base analysis. Analysis 4 is only going to consider the steel girder sections on their own with the Transverse Slab being deactivated. Therefore it is not important what material properties the Transverse Slab has in Analysis 4.

The Transverse Slab will be deactivated by using the activate and deactivate facility within LUSAS.

- Select the **Deactivate** option and click **Next**
- Select the **Percentage to redistribute** option and leave the value as **100%**. Enter the attribute name as **Deactivate**, then press **Finish**
- In the  Treeview, click the right-hand mouse button on the group name **Transverse Slab** and select the **Select Members** option from the menu. If you already have some features selected click **Yes** to deselect them first.
- From the  Treeview, drag and drop the deactivation attribute **Deactivate** onto the selected Lines. Make sure that the analysis option is set to **Analysis 4 Phase 1 Non-Composite Self Weight** and the loadcase **Steel Self Weight**.

Attributes
 Activate and
 Deactivate...



Defining and Assigning Loading in Analysis 4

In the fourth analysis the dead load of the steel beams and the weight of the concrete acting on the main girders will be considered.

Attributes
Loading...

- Select the **Body Force** option and click **Next**.
- Enter an acceleration of **-9.81** in the Z direction.
- Enter an attribute name of **Gravity** and click **Finish**.

Attributes
Loading...

- Select the **Global distributed** option and click **Next**.
- Set the type to **Per unit length**, the Z direction as **-22685** N/m.
- Enter an attribute name of **Weight of Slab** and click **Finish**.
- In the  Treeview, click the right-hand mouse button on the group name **Main Girders** and select the **Select Members** option from the menu. If you already have some features selected click **Yes** to deselect them first.
- From the  Treeview, drag and drop the loading attribute **Gravity** onto the selected Lines. Make sure that the analysis option is set to **Analysis 4 Phase 1 Non-Composite Self Weight** and loadcase **Steel Self Weight**.
- With the members of the group **Main Girders** still selected, drag and drop the loading attribute **Weight of Slab** from the  Treeview onto the selected Lines. Make sure that the analysis option is set to **Analysis 4 Phase 1 Non-Composite Self Weight** and using the loadcase selection, select **New** from the drop-down list, and enter the name **Concrete Self Weight**. Click **OK**.

Additional Traffic load patterns

Now that the basic analysis models have been defined, the additional Traffic load Patterns can be created.

In order to use the vehicle load optimisation facility the locations (points or nodes) at which the optimised load patterns are to be created need to be selected as well as the LUSAS component of interest.

To do this, influence attributes are defined and assigned to the model. LUSAS then calculates the influence surfaces for any specified position in the structure. Two methods are available: the Reciprocal Method and the Direct Method. Since in this example only two locations are going to be considered the Reciprocal method will be used. See the Online Help for details of these two methods.



Note. Only two locations are going to be considered as this example is only considering two locations for detailed design. In reality many locations would need to

be considered to cover the full design of the bridge, but for clarity this simplification will be accepted. The design checks will be carried out along girder 2, at the middle of span 1 and also over the pier support.

Defining Influence Attributes

The first influence attribute will be used to investigate the bending moment at near the middle of span 1 on girder 2.

- Select a **Moment** influence type for an **About transverse** influence direction for a **Negative** displacement direction. Enter the influence attribute name as **Sagging moment** and click **OK**. The influence attribute will be added to the Treeview.



The second influence attribute will be used to investigate the bending moment over the pier on girder 2.

- Select a **Moment** influence type for an **About transverse** influence direction for a **Positive** displacement direction. Enter the influence attribute name as **Hogging moment** and click **OK**. The influence attribute will be added to the Treeview.

Assigning Influence Attributes

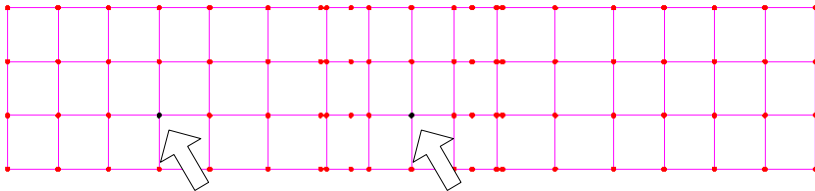
Influence attributes will be assigned at the middle of span 1 on girder 2, and at the pier on girder 2. See image that follows.



- Select the Point (10.5, 3.7) as shown on girder 2.
- From the  Treeview, drag and drop the influence attributes **Sagging moment** onto the selected Point. This will automatically be assigned into a new Reciprocal Influence Analysis.
- Select the Point (28.0, 3.7) at the pier on girder 2.
- From the  Treeview, drag and drop the influence attributes **Hogging moment** onto the selected Point. This will automatically be assigned into a new Reciprocal Influence Analysis.

Visualising the Defined Influence Points

Influence attribute assignments are visualised as they are assigned to the model. To check that the influence attribute orientations are correct (meaning that the correct influence directions have been defined) an isometric view of the model should be used.



Select the isometric button.

- Ensure that the influence visualisations are as shown

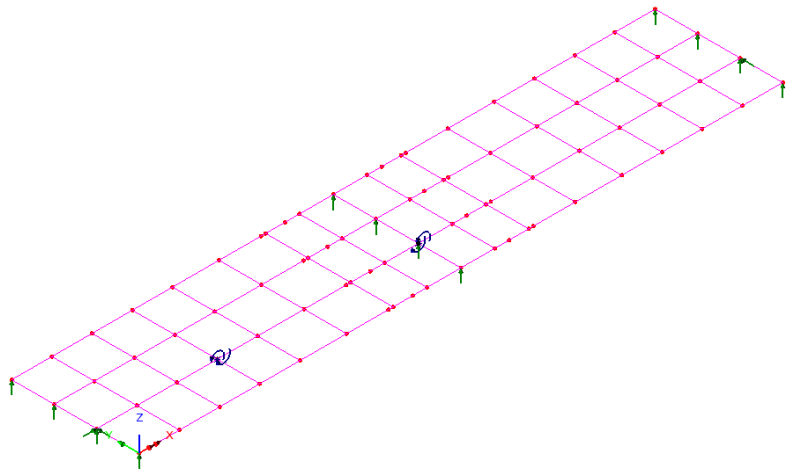

Using the Vehicle Load Optimisation facility to calculate the worst case traffic loading patterns

The vehicle load optimiser automates the creation of load datasets in accordance with the chosen loading code for the locations and effects specified. Before invoking the Vehicle Load Optimisation Wizard the kerb lines need to be defined.



Select the Home button to return the model to the default view.

Defining Kerb Lines



Enter coordinates of $(-5, 0.9)$, and $(61.0, 0.9)$, to define a line representing one of the kerbs, and click OK.



Enter coordinates of $(-5, 10.2)$, and $(61.0, 10.2)$, to define a line representing the other kerb, and click OK.

Geometry >
Line >
Coordinates...

Geometry >
Line >
Coordinates...

- Select the first and second kerb line. (Use the **Shift** key to add to the initial selection)

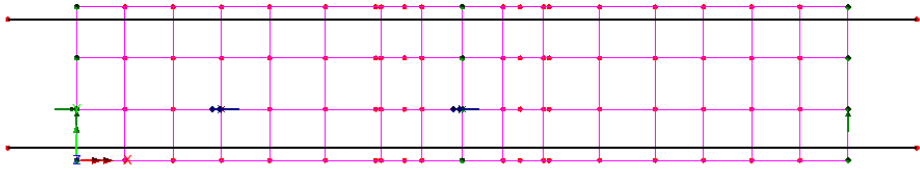

Vehicle Load Optimisation

Now that influence attributes have been defined and assigned, the VLO facility can be used to define optimised traffic loading for the bridge, based on a chosen code of practice. For this example design code EN1991-2 UK will be used. In this code, normal traffic is represented by Load Model 1 (LM1).

For the road carried by this bridge, the highway authority has also specified that the abnormal traffic be represented by the special vehicle SV100, as defined in the UK National Annex.



It will be assumed that the traffic loading will be the leading variable action and therefore only characteristic and frequent values will be considered within the VLO facility.

- Ensure that the lines representing the kerbs are still selected
- Select **United Kingdom** from the Country drop down list and choose **EN1991-2 UK 2009** as the Design code.
- Press the **Optional Code settings** button and ensure that only **Characteristic** and **Frequent** representative values required are checked (ticked). Ensure that **Group 1a –LM1, Group 4 –LM4 and Group 5 –LM3** load groups are to be included. For the vehicle selector, press the button and deselect the SV80 option and select the **SV100** vehicle only. Press **OK** to exit the dialog.
- Press the **Define carriageways** button. Ensure **Kerbs from selection** is selected and press **Apply** to exit the dialog.
- Press the **Set influence surfaces** button, and on the next dialog select **Include all influence surfaces**.
- Ensure that the **Positive** checkboxes are selected for both the Sagging and Hogging moment. This means that the VLO analysis will produce loading patterns for positive regions of the influence shape.



Note. Clicking in the header cell of a column will select the whole column so that checking (ticking) one entry will check (tick) all entries in that column.

- Press **OK** to return to the main VLO dialog.
- Ensure the option to **View onerous effect table** is not selected.
- Ensure the option to **Create loading patterns** for **All chosen influences** is selected.
- To specify a non-default analysis name choose **New** from the drop-down list, and enter the analysis name to be **VLO Analysis 5**
- Change the VLO run Name to be **VLO Eurocode**
- Press **OK** which will run generate the optimised loading patterns for the influence points of interest.

After a short time, and at the bottom of the  Treeview, a new entry **VLO Analysis 5** will be created. This contains the loading from  VLO run, as denoted by this icon, , which includes Characteristic and Frequent load combinations for the locations requested.

- By setting a loadcase active and turning on the  loading, the traffic loading patterns for each influence result can be seen.

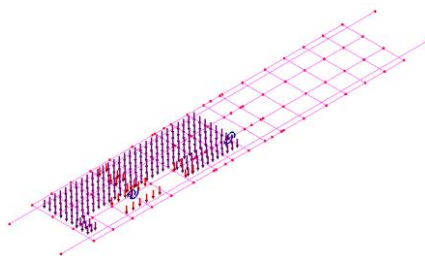

Loading pattern
for influence result in span 1 for loadcase
Sagging moment - Positive - Characteristic

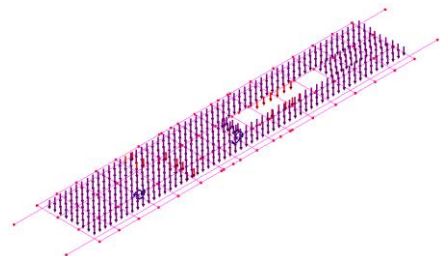

Loading pattern
for influence result at pier for loadcase
Hogging moment - Positive - Characteristic

File
Save



Save the model file.

Solve the model



Click the **Solve now** button and press **OK** to run all the analyses using LUSAS Solver and load the results file.

Combinations and envelopes

Now that all the Analyses and their respective load cases have been created, combinations and envelopes for each Phase and for each Limit State the can be defined.

Four cases will be defined, **ULS Fundamental**, **SLS Characteristic**, **SLS Frequent** and **Fatigue**.

Before the limit state combinations can be created some initial envelopes need to be created.

Analyses
Envelope...

- Include the **Thermal heat** and the **Thermal cool** loadcases from Analysis 1.
- Click the  button to add these loadcases to the included list.
- Change the envelope name to **Thermal Envelope**

Click the **OK** button to complete the definition and create a envelope in the  Treeview.

Repeat the above steps for the following envelopes



Note. The loadcase names used below will depend on exact point selected in model and how the model was constructed. Therefore the loadcase names might have different point numbers in the name string.

Analyses
Envelope...



- Include the **Sagging moment - Point 76 - Positive – Characteristic** and the **Hogging moment - Point 86 - Positive – Characteristic** loadcases from Analysis 5, change the name to **Characteristic Envelope** and click OK.

Analyses
Envelope...

- Include the **Sagging moment - Point 76 - Positive – Frequent** and the **Hogging moment - Point 86 - Positive – Frequent** loadcases from Analysis 5, change the name to **Frequent Envelope** and click OK.

Limit state Combinations

Before creating the combinations the way that the factors are displayed will be changed.

- In the  Treeview double-click on the  **Combinations and envelope options**, and ensure that the option **Display beneficial/adverse factors for smart combinations** is selected (checked).



Note. If the last action is not undertaken the smart combination will show factors as permanent and variable. **Permanent load factor** is always applied and a **Variable load**

factor is only applied if the effect is adverse. The option that is set changes the dialog Permanent/Variable to Beneficial/Adverse.

The following table shows the analyses and the loadcases that they contain – the loadcases that will be combined to form the required limit state combinations.

Analysis	Construction Phase	Loadcase
Analysis 4	Phase 1	Steel Self Weight Concrete Self Weight
Analysis 3	Phase 2a	Surfacing
Analysis 2	Phase 2b	Settlement Shrinkage
Analysis 1	Phase 3	Thermal heat Thermal cool
Analysis 5	VLO using properties from Phase 3	Sagging moment - Point 76 - Positive – Characteristic Sagging moment - Point 76 - Positive – Frequent Hogging moment - Point 86 - Positive – Characteristic Hogging moment - Point 86 - Positive – Frequent



Note. In this example the number of loadcases included into each construction phase has been kept to a minimum to ensure the example is as concise as possible but still covers the basics of what is required. It is recognised that further actions could be included in each of the construction phases, for example **Analysis 5** could include the variable action **Wind**. However, it is intended that this example shows the process of using the Composite Deck Designer (**PontiEC4**) with **LUSAS** from start to finish. Once this is understood additional actions can easily be fitted into the process.

The following table shows the envelopes that will also be combined with the basic loadcases to form the required limit state combinations.

Envelope	Envelope loadsets
Thermal Envelope	Thermal Envelope (Max) Thermal Envelope (Min)
Characteristic Envelope	Characteristic Envelope (Max) Characteristic Envelope (Min)
Frequent Envelope	Frequent Envelope (Min) Frequent Envelope (Max)

ULS Combinations

The factors in the combinations will be based on the traffic loading being the leading variable action.

ULS_Fundamental_Phase1

This creates a smart load combination in the  Treeview.

- Include the Steel and Concrete **Self Weight** loadcases from Analysis 4 in the smart combination.
- Click the  button to add these loadcases to the included list.
- Set the permanent and variable factors as shown in bold in the table that follows:

Name	Beneficial factor	Adverse factor
Steel Self Weight	0.95	1.2
Concrete Self Weight	0.95	1.35

Values are taken from UK NA to EN1990: Table NA.A2.4(B) Design Values For Actions. Steel Self weight $\gamma_{G,sup} = 1.20$ and $\gamma_{G,inf} = 0.95$ and Concrete Self weight $\gamma_{G,sup} = 1.35$ and $\gamma_{G,inf} = 0.95$

- Change the smart combination name to **ULS_Fundamental_Phase1** and Click **OK**.
- Repeat the above procedure for the following smart combinations:

ULS_Fundamental_Phase2a

Name	Beneficial factor	Adverse factor
Surfacing	0.95	1.2

Values are taken from UK NA to EN1990: Table NA.A2.4(B) Design Values For Actions. Road Surfacing $\gamma_{G,sup} = 1.20$ and $\gamma_{G,inf} = 0.95$

- Enter smart combination name: **ULS_Fundamental_Phase2a**

ULS_Fundamental_Phase2b

Name	Beneficial factor	Adverse factor
Settlement	0.0	1.2
Shrinkage	0.0	1.0

Values are taken from UK NA to EN1990: Table NA.A2.4(B) Design Values For Actions. Settlement $\gamma_{G,sup} = 1.20$ and $\gamma_{G,inf} = 0.0$. The Partial factor for shrinkage γ_{shr} is set to unity for both ULS and SLS by EN 1992-1-1, Clause 2.4.2.1.

No clear guidance is given on factors for shrinkage but in this example it will be considered $\gamma_{G,sup} = 1.20$ and $\gamma_{G,inf} = 0.0$

- Enter smart combination name: **ULS_Fundamental_Phase2a**

ULS_Fundamental_Phase3a

Name	Beneficial factor	Adverse factor
Thermal Envelope (Max)	0	1.55*0.6
Thermal Envelope (Min)	0	1.55*0.6

Values are taken from UK NA to EN1990: Table NA.A2.4(B) Design Values For Actions. Thermal $\gamma_{G,sup} = 1.55$ and $\gamma_{G,inf} = 0.0$ and Table NA.A2.1 – Recommended values of ψ factors for road bridges $\psi_0=0.6$. This can be entered and will be evaluated by Modeller as 1.55*0.6

- Enter smart combination name: **ULS_Fundamental_Phase3a**

ULS_Fundamental_Phase3b

Name	Beneficial factor	Adverse factor
Characteristic Envelope (Max)	0	1.35
Characteristic Envelope (Min)	0	1.35

Values are taken from UK NA to EN1990: Table NA.A2.4(B) Design Values For Actions. Road Traffic $\gamma_{G,sup} = 1.35$ and $\gamma_{G,inf} = 0.0$. Note the Vehicle Load Optimiser has already included the appropriate ψ values from Table NA.A2.1.

- Enter smart combination name: **ULS_Fundamental_Phase3b**

SLS Combinations

SLS_Characteristic_Phase1

Name	Beneficial factor	Adverse factor
Steel Self Weight	1.0	1.0
Concrete Self Weight	1.0	1.0

Values are taken from EN 1990 Clause: 6.5.3 (2)

- Enter smart combination name: **SLS_Characteristic_Phase1**

SLS_Characteristic_Phase2a

Name	Beneficial factor	Adverse factor
Surfacing	1.0	1.0

Values are taken from EN 1990 Clause: 6.5.3 (2)

- Enter smart combination name: **SLS_Characteristic_Phase2a**

SLS_Characteristic_Phase2b

Name	Beneficial factor	Adverse factor
Settlement	0.0	1.0
Shrinkage	0.0	1.0

Values are taken from EN 1990 Clause: 6.5.3 (2). The Partial factor for shrinkage γ_{shr} is set to unity for both ULS and SLS by EN 1992-1-1, Clause 2.4.2.1.

- Enter smart combination name: **SLS_Characteristic_Phase2b**

SLS_Characteristic_Phase3a

Name	Beneficial factor	Adverse factor
------	-------------------	----------------

Thermal Envelope (Max)	0	1.0 x 0.6
Thermal Envelope (Min)	0	1.0 x 0.6

Values are taken from EN 1990 Clause: 6.5.3 (2) and Table NA.A2.1 – Recommended values of ψ factors for road bridges $\psi_0=0.6$.

- Enter smart combination name: **SLS_Characteristic_Phase3a**

SLS_Characteristic_Phase3b

Name	Beneficial factor	Adverse factor
Characteristic Envelope (Max)	0	1.0
Characteristic Envelope (Min)	0	1.0

Values are taken from EN 1990 Clause: 6.5.3 (2)

- Enter smart combination name: **SLS_Characteristic_Phase3b**

SLS_Frequent_Phase1

Name	Beneficial factor	Adverse factor
Steel Self Weight	1.0	1.0
Concrete Self Weight	1.0	1.0

Values are taken from EN 1990 Clause: 6.5.3 (2)

- Enter smart combination name: **SLS_Frequent_Phase1**

SLS_Frequent_Phase2a

Name	Beneficial factor	Adverse factor
Surfacing	1.0	1.0

Values are taken from EN 1990 Clause: 6.5.3 (2)

- Enter smart combination name: **SLS_Frequent_Phase2a**

SLS_Frequent_Phase2b

Name	Beneficial factor	Adverse factor
Settlement	0.0	1.0
Shrinkage	0.0	1.0

Values are taken from EN 1990 Clause: 6.5.3 (2). The Partial factor for shrinkage γ_{shr} is set to unity for both ULS and SLS by EN 1992-1-1, Clause 2.4.2.1.

- Enter smart combination name: **SLS_Frequent_Phase2b**

SLS_Frequent_Phase3a

Name	Beneficial factor	Adverse factor
Thermal Envelope (Max)	0	1.0 x 0.5
Thermal Envelope (Min)	0	1.0 x 0.5

Values are taken from EN 1990 Clause: 6.5.3 (2) and Table NA.A2.1 – Recommended values of ψ factors for road bridges $\psi_2=0.5$.

- Enter smart combination name: **SLS_Frequent_Phase3a**

SLS_Frequent_Phase3b

Name	Beneficial factor	Adverse factor
Frequent Envelope(Max)	0	1.0 x 0.75
Frequent Envelope (Min)	0	1.0 x 0.75

Values are taken from EN 1990 Clause: 6.5.3 (2) and Table NA.A2.1 – Recommended values of ψ factors for road bridges $\psi_1=0.75$

- Enter smart combination name: **SLS_Frequent_Phase3b**

Fatigue Combinations



Note. For the **Fatigue** case the Load Model 1 are similar to those defined for the Frequent loading, therefore this will be used for the **Fatigue** limit state. However the Fatigue Load Model 1 is defined in with the values of the axle loads equal to $0,7Q_{ik}$ and the values of the uniformly distributed loads equal to $ik,0,3q$. Therefore using the load patterns created by the VLO facility without modification would be excessively conservative. However to save time in this example an assumed load reduction factor will be applied to the whole load pattern in a combination with a factor of 0.5. This is a gross assumption for the example and in reality the correct loading should be defined.

Name	Beneficial factor	Adverse factor
Frequent Envelope(Max)	0	1.0 x 0.5
Frequent Envelope (Min)	0	1.0 x 0.5

- Enter smart combination name: **Fatigue**

Running the model

File
Save



Save the model file.



Solve the model



Click the **Solve now** button and press **OK** to run the analysis using LUSAS Solver and load the results file.

View initial results

Once the model has been solved the results can be viewed within LUSAS Modeller to create bending moment diagrams etc. To show how this is done:

- In the Analyses  treeview, set active loadcase **ULS_fundamental_Phase3b (Min)**, choose entity **Force/Moment** and component **My**
- Right-click in the view window and add the **Diagrams** layer, selecting entity **Force/Moment** and component **My**. Ensure **Show minimum only** is selected, and click **OK**.
- In the Groups  treeview, right click on **Main Girders** and select **Set As Only Visible**.

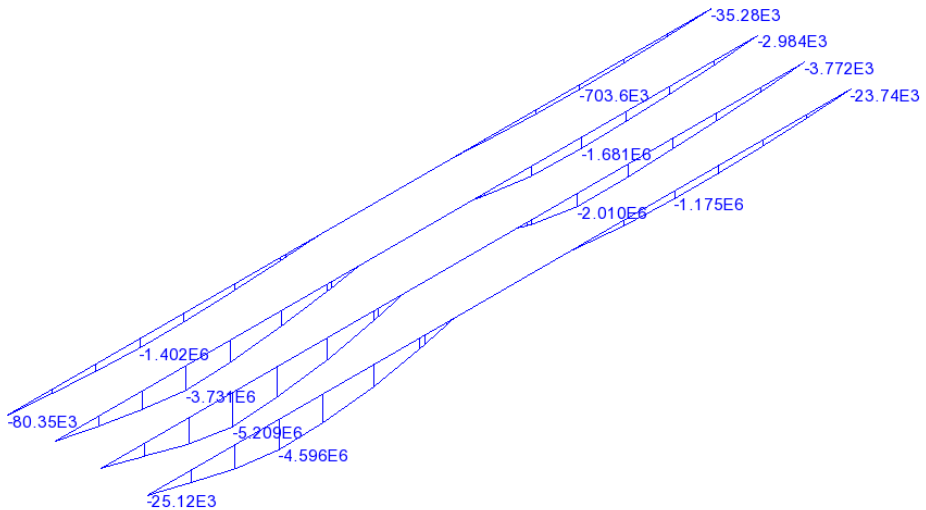

This worked example will not carry out any other processing or viewing of results within LUSAS Modeller, instead the results will be exported back to the Composite Deck Designer (PontiEC4) where the detailed design checks will be made.

Part 4: Exporting the force and moment data from LUSAS to the Composite Deck Designer (PontiEC4)

Associated File

This supplied file is only for use in case of problems in manually creating the appropriate data in the previous section of the example.



- **Force_and_Moments.xls** File created by the LUSAS Export Forces and Moments dialog containing data to import into PontiEC4.

Selection of elements for checking

As discussed earlier, for simplicity only two locations will be considered for detailed design. In reality many locations would need to be considered to cover the full design of the bridge. The design checks will be carried out along girder 2, near the middle of span 1 and also over the pier support.

- In the View window, right-click and select **All Visible**.

Part 4: Exporting the force and moment data from LUSAS to the Composite Deck Designer (PontiEC4)

- Turn off the display of the **Diagrams** layer
- Turn on the display of the **Mesh** layer
- Select the elements along girder 2, at the middle of span 1, and also over the pier support as shown on the following image.



Note. To select the elements with the geometry still visible use the **Select Elements** toolbar button  to only select the elements required, holding down the **Shift** key to add to the initial selection. Depending on how the model was constructed the exact element and node numbers might be different from those showing in this example.

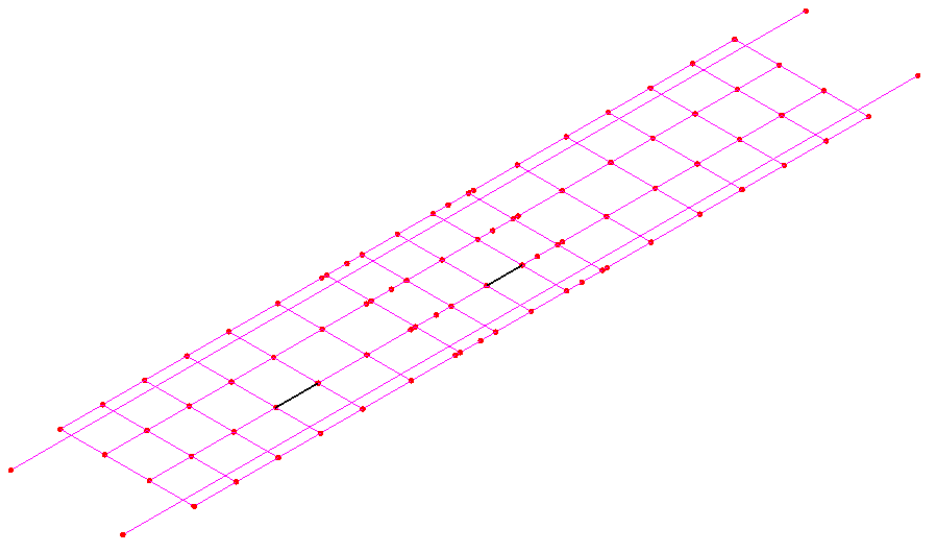

With the elements selected, the results for just these elements can be exported

- Select the **Design > Export to Composite Deck Design ...** menu item.
- In the Analysis selection dialog that appears, select **Analysis 1 Phase 3 Composite Variable Actions** from the drop-down list provided, and click **OK**. The chosen analysis will be used to determine if sections are cracked or un-cracked.

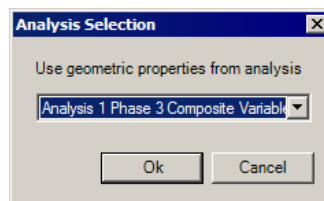

Composite Highway Bridge Design

- On the Export Forces and Moments dialog, choose the **Selected Sections** tab. These sections have been defined based on the elements selected prior to selecting the **Bridge > Composite Deck Designer > Export...** menu item.

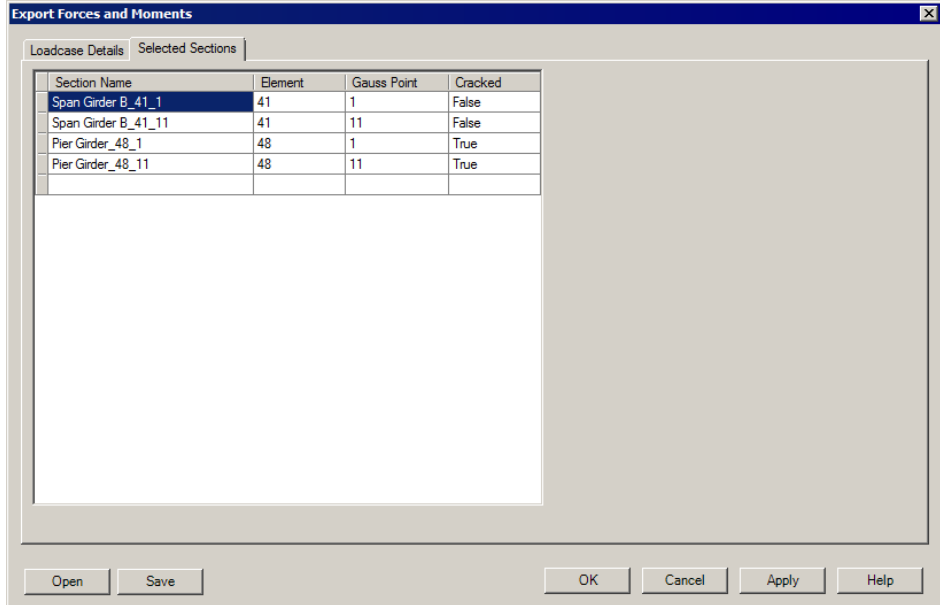

For each selected element, the table defines two sections, representing the first and last Gauss points. Each Section name listed has the following information: **Element (number), Gauss point (number), Cracked/uncracked section status.**

The section names in this table are created from the following named objects/values in the LUSAS model:

“[Segment Name]+“_”+ “[Element number]+“_”+[Gauss Point Number]



Important. The Export Forces and Moments facility obtains the segment and the phase name from the name of the assigned geometric attribute, by splitting the attribute name on the double underscore separator “_”. For this reason the cross-section geometric properties in any associated LUSAS model must have a name that follows this standard:

[Segment Name] +”_”+ [Phase name]; where the phase name should be: {F1, F2a, F2b, F3a, F3b, cracked}.

The cracked status of the section is a Boolean value taken as true when the phase name is “cracked”, and false otherwise.

Part 4: Exporting the force and moment data from LUSAS to the Composite Deck Designer (PontiEC4)

- Click the “**Loadcase Details**” tab.

On the Loadcase Details tab the design combinations, design limit states and phases are to be stated, along with the specification of shrinkage/thermal coefficients and component values of interest.

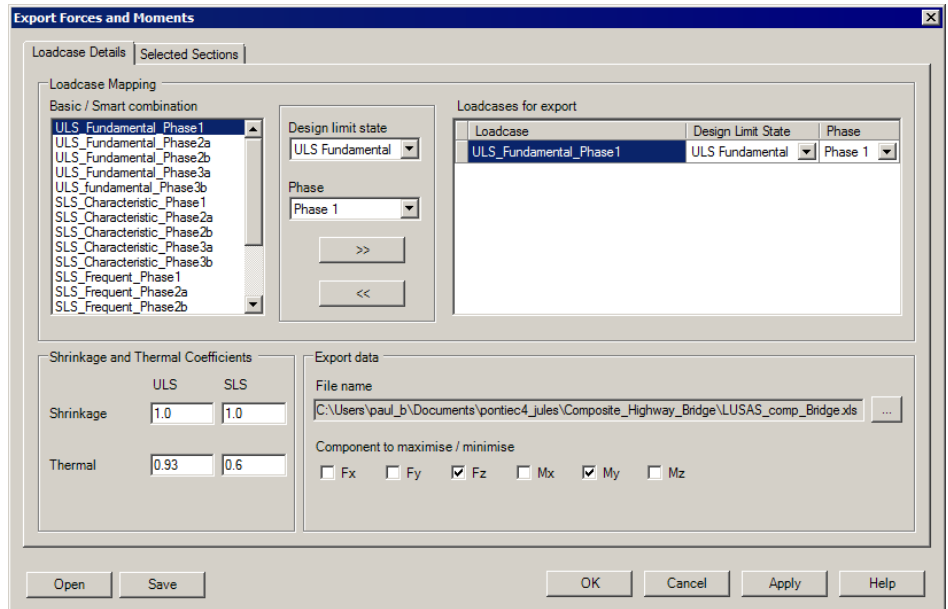

To assemble a design combination, proceed as follows:

- In the left-hand panel select **ULS_Fundamental_Phase1**, select a Design limit state of **ULS_Fundamental**, and from the Phase drop-down list select **Phase 1**. Click the ‘Add to’ button  to add the design combination to the right-hand panel
- Repeat the above sequence for all combinations listed in the table that follows, (noting that Phase 2c is not used) by selecting a Basic / smart combination and the corresponding **Design limit state** and **Phase** for each one.

Basic / Smart combination	Design limit state	Phase
ULS_Fundamental_Phase1	ULS Fundamental	Phase 1
ULS_Fundamental_Phase2a	ULS Fundamental	Phase 2a
ULS_Fundamental_Phase2b	ULS Fundamental	Phase 2b
ULS_Fundamental_Phase3a	ULS Fundamental	Phase 3a
ULS_Fundamental_Phase3b	ULS Fundamental	Phase 3b

Composite Highway Bridge Design

Basic / Smart combination	Design limit state	Phase
SLS_Characteristic_Phase1	SLS Characteristic	Phase 1
SLS_Characteristic_Phase2a	SLS Characteristic	Phase 2a
SLS_Characteristic_Phase2b	SLS Characteristic	Phase 2b
SLS_Characteristic_Phase3a	SLS Characteristic	Phase 3a
SLS_Characteristic_Phase3b	SLS Characteristic	Phase 3b
SLS_Frequent_Phase1	SLS Frequent	Phase 1
SLS_Frequent_Phase2a	SLS Frequent	Phase 2a
SLS_Frequent_Phase2b	SLS Frequent	Phase 2b
SLS_Frequent_Phase3a	SLS Frequent	Phase 3a
SLS_Frequent_Phase3b	SLS Frequent	Phase 3b
SLS_Frequent_Phase1	Fatigue	Phase 1
SLS_Frequent_Phase2a	Fatigue	Phase 2a
SLS_Frequent_Phase2b	Fatigue	Phase 2b
SLS_Frequent_Phase3a	Fatigue	Phase 3a
Fatigue Combination	Fatigue	Phase 3b

- Input a Shrinkage coefficient of **1.0** for the ULS and SLS.
- Input a Thermal coefficient of **1.35x0.6=0.93** for the ULS and **1.0x0.6=0.6** for the SLS
- In the ‘Component to maximize/minimize’ panel ensure **Fz** and **My** are checked. (These are the components that will be considered in the smart combinations)
- Click the ellipsis button  to choose the folder and name of the xls file to create (e.g.: <current work directory>**Forces_and_moments.xls**), pressing the **Save** button to return to the main dialog.
- Click the **Save** button on the bottom-left of the dialog to save the data entered in the dialog pages for any possible re-use. Save the input as **“Export_Forces_to_PontiEC4.inp”**.

Then, finally, click **OK** to create the XLS file for use in PontiEC4.

Part 5: Importing force and moment data to the Composite Deck Designer (PontiEC4) and assessing design results

Associated File

This supplied file is only for use in case of problems in manually creating the appropriate data in the previous section of the example.



- Forces_and_moments.xls** File created by the LUSAS Export Forces and Moments dialog containing data to import into PontiEC4.
- LUSAS_Comp_Bridge.csv** - the input file for PontiEC4 with data on sections and materials.

Importing force and moment data into PontiEC4

This section covers the import of section force and moment data from LUSAS into PontiEC4. Refer to the “Forces and moments” section in the PontiEC4 online help file for more information.

Whilst it is possible to manually enter forces and moments into PontiEC4 in the “Forces and moments” dialog, and it is also possible to copy and paste data into each section, when used with LUSAS any importing of data is far better achieved by using the automated procedure as follows.

- In PontiEC4, with the current data still loaded (or with the data from the previously saved file “LUSAS_Comp_Bridge.csv” loaded if the example had been saved and closed for some reason at that point), select the **File> Import forces/moments** menu item and load the file **Forces_and_moments.xls** from working project folder.

PontiEC4 will detect that four additional sections are present (these are the sections at the beginning and end of each beam element that was selected to signify a change of cross-section geometric property in the LUSAS model) and ask if they are to be added to their corresponding segments.

- Click **Yes** to import the new sections. This operation may take a few seconds to complete. The status bar will show the progress.
- From the main menu select **Windows> 2 Geometry** to display the Geometry dialog. In the Segment treeview the new sections added to each segment can be seen.

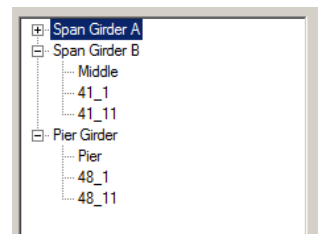

- If any previously defined initial sections for each segment (named **Middle** or **Pier** are present these are no longer necessary and should be deleted. To do this, select each section name in turn, click the right-hand mouse button, and choose **Delete**.
- Also, any segment that does not have a section within it that is being used within the design checks can also be deleted. In this example no design checks are being carried out on the Span girder A segment so this should be deleted. To do this, select each segment name, click the right-hand mouse button, and choose **Delete**. This leaves the treeview as shown.

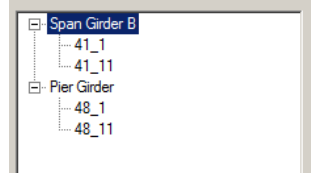

Note. If any mistakes are made in deleting the unwanted sections, a re-import of the `forces_and_moments.xls` file will re-insert any deleted sections.

- Select **File> Save As** and enter a file name of `LUSAS_Comp_Bridge_Results.csv` to save the PontiEC4 dialog data to the working project folder before proceeding to view the results.

This concludes the data input.

Assess the results and detailed design checks

The design locations can now be assessed for Ultimate, Serviceability, and Fatigue limit states. It involves:

1. **Viewing utilisation factors for all checks performed**
2. **Updating section sizes for any over-utilised sections**
3. **Viewing updated results**
4. **Updating the LUSAS model and re-analysing the revised sections**

It is usually enough to cycle through steps 1 to 4 once, or perhaps twice, to obtain an optimized structure.

Limited details have been given about all the checks that are carried out. To find out more about the checks performed refer to the PontiEC4 online Help, where design code and theory details are also supplied.

Viewing design results in PontiEC4

- With the results loaded in **PontiEC4** select the **Window> Summary of results** menu item. This carries out the design computations in PontiEC4 and displays the results for deck sections in a summary form.

Part 5: Importing force and moment data to the Composite Deck Designer (PontiEC4) and assessing design results

The meaning of the coloured utilization factor entries is explained in the following table:

Colour of value / text	Utilization factor	Meaning
Red	Greater than 1.0	Value has failed the check carried out.
Green	Less than 1.0	Value has passed the check carried out.
Grey - without parentheses	Any	Value of potential interest but the utilisation factor is not relevant to the code.
(Grey) - with parentheses	Any	Value of potential interest but the utilisation factor is not relevant to the code in this particular context.
Grey stating 'No int.'	Not applicable	No interaction between bending and shear.

A check of the utilization factors obtained should be made for each limit state. Only a check for the Fundamental ULS combination will be shown here.



Note. By clicking on a particular header the values in a column can be sorted in increasing or decreasing value

The screenshot displays a software window titled 'Summary of results' with four main panels:

- Fundamental ULS combination:** A table with columns for Section, X (m), Combination, Class (Pt.1), Class (Pt.2), MEI/MR, SigEd (y), VEI/VEd, MEI/MRd, VEI*/bw.Fd, V/M/N, VEI*/(n*PRd), End Stubs, Longitudinal Stiffness LTB, and Vt/St. It lists various sections like Span Girders and Pier Girders with their respective utilization factors.
- Characteristic SLS combination:** A table with columns for Section, X (m), Combination, SigEd / Sig adm, and vEd (kN/m). It shows utilization factors for different sections.
- Fatigue combination:** A table with columns for Section, X (m), Combination, Stubs Ea1, Stubs Ea2, Stubs Ea3, Flange top, Flange bot, Web, Flap/Flap, Flap/Flap, Web-Flap, Web-Flap, and Vt/St-Web. It provides detailed fatigue analysis data.
- Frequent SLS combination:** A table with columns for Section, X (m), Combination, and Web breathing. It shows utilization factors for frequent service limit states.



Note. Changing from the Geometry, Materials or Forces and moments dialogs to the Results, Summary of results, Report, or Cracking dialogs causes a re-analysis of results.

It can be seen that the summary of the results page is showing that ULS and SLS checks have passed **Green** but the Fatigue combination has a number of **Red** Fails.

- Select the **Window > Results** menu item in order to find out more about the failed checks.

Composite Highway Bridge Design

- In the Cross-sections and design combinations panel select section **Span Girder B_41_1** and **FLS steel, Mmax**

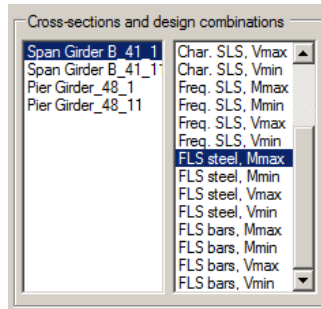

- Then, in the lower part of the Results dialog, select the **FLS steel** tab:

Detail	gFDStgE	DSigRs/gM	c.s.
Upper flange joint	73.48	75.52	0.973
Lower flange joint	85.12	75.52	1.127
Web-Upper flange attachment	69.87	82.96	0.842
Web-Lower flange attachment	77.91	82.96	0.939
Vertical stiffener-Web attachment	77.91	59.26	1.315
Vertical stiffener-Upper flange attachment	69.87	59.26	1.179
Vertical stiffener-Lower flange attachment	77.91	59.26	1.315
Longitudinal stiffener 1-Web attachment	--	--	--

$\gamma_{FF} = 1$ $\gamma_{MS} = 1.35$
 $\lambda = \lambda_1 \lambda_2 \lambda_3 \lambda_4 = 2.37 \times 0.848 \times 1 \times 1 = 2.009 > 2 \rightarrow 2$ (Midspan) (Moment)
 $2.538 \times 0.848 \times 1 \times 1 = 2.152$ (Midspan) (Shear)
 $\Delta \sigma_{Ra} = \Delta \sigma_{Rak} * ks = 112 \times 0.91 = 102 \text{ N/mm}^2$ (Bottom flange junction)
 $112 \times 0.91 = 102 \text{ N/mm}^2$ (Top flange junction)

$\gamma_{FF} \Delta \tau_E \leq \frac{\Delta \tau_{E,c}}{\gamma_{FF,s}}$ $7.7 < 90 \text{ N/mm}^2$
 $\gamma_{FF} \Delta \sigma_E \leq \frac{\Delta \sigma_{E,c}}{\gamma_{FF}}$ $73.5 > 59.3 \text{ N/mm}^2$ (*)
 $\frac{\gamma_{FF} \Delta \sigma_E}{\Delta \sigma_{E,c}} + \frac{\gamma_{FF} \Delta \tau_E}{\Delta \tau_{E,c}} \leq 1.3$ $1.24 + 0.09 = 1.33 > 1.3$ (*)

CHECK PASSED (*) Checks not relevant (Top flange c)

$\Delta \sigma_c = 80 \text{ N/mm}^2$ $\Delta \sigma_E = \lambda$ $\Delta \sigma_p = 73.48 \text{ N/mm}^2$ $\Delta \sigma_p = 36.74 \text{ N/mm}^2$
 $\Delta \tau_c = 90 \text{ N/mm}^2$ $\Delta \tau_E = \lambda_v \Delta \tau_p = 7.72 \text{ N/mm}^2$ $\Delta \tau_p = 8.62 \text{ N/mm}^2$
 $\lambda = \lambda_1 \lambda_2 \lambda_3 \lambda_4 = 2.37 \times 0.848 \times 1 \times 1 = 2.009 > 2 \rightarrow 2$ (Span)
 $\lambda_v = \lambda_{v1} \lambda_{v2} \lambda_{v3} \lambda_{v4} = 1 \times 0.896 \times 1 \times 1 = 0.896$
 Studs: $\gamma_{FF} = 1$ $\gamma_{MS} = 1$
 Structural steel: $\gamma_{FF} = 1$ $\gamma_{MS} = 1.35$

The fatigue failures could be down to an underlying weakness in the Fatigue strength of the structure, however it is generally considered that Fatigue Load Model 1 is conservative, and if Fatigue Load Model 3 were considered instead, a better result would be obtained. Therefore it is recommended that the load model used for the Fatigue case be changed to adopt **Fatigue Load Model 3**.

Part 6: Viewing optimised results

Associated File



- Forces and moments optimised.xls** File created by the LUSAS Export Forces and Moments dialog containing data to import into PontIEC4.

The supplied file “Forces_and_moments_optimised.xls” is from a modified LUSAS analysis model where the simplified fatigue loading using Fatigue Load Model 1 has been replaced by the Fatigue Load Model 3. This was done by using the static vehicle library and the LUSAS moving load facility to drive the single Fatigue Load Model 3 along the bridge deck above girder 2. These results were then enveloped to create the fatigue combination.

- In PontiEc4, select the **File> Import forces/moments** menu item and load the file **Forces_and_moments_optimised.xls** from working project folder.
- Select the **Window> Summary of results** menu item.

Fundamental ULS combination														Characteristic SLS combination						
Section	X (m)	Combination	Class	Class	MEd/NR	StdEd	VEd/VEd,Rd	MEd/NR,Rd	VEd/VEd,Rd	V,M/Rd	VEd/VEd,Rd	V,M/Rd	End	Longitudinal	Vertical	Vertical	Vertical	Vertical		
			Ph.1	Ph.2	(kN/m)	(kN/m)							Stress	Stiffness	Stiffness	Stiffness	Stiffness	Stiffness	Stiffness	
Span Girder B_4	10.500	Fund ULS Mmax	4	1	0.14	(2277)	0.062	0.18	0.067	No int.	0.003	0	0	0	0	0	0	0	0	0
Span Girder B_4	10.500	Fund ULS Mmin	4	1	0.63	(7017)	0.172	0.72	0.179	No int.	0.094	0	0	0	0	0	0	0	0	0
Span Girder B_4	10.500	Fund ULS Vmax	4	1	0.53	(661)	0.188	0.65	0.196	No int.	0.103	0	0	0	0	0	0	0	0	0
Span Girder B_4	10.500	Fund ULS Vmin	4	1	0.37	(481)	0.036	0.42	0.027	No int.	0.04	0	0	0	0	0	0	0	0	0
Span Girder B_4	14.000	Fund ULS Mmax	4	1	0.12	(176)	0.07	0.14	0.075	No int.	0.023	0	0	0	0	0	0	0	0	0
Span Girder B_4	14.000	Fund ULS Mmin	4	1	0.56	(609)	0.181	0.64	0.189	No int.	0.094	0	0	0	0	0	0	0	0	0
Span Girder B_4	14.000	Fund ULS Vmax	4	1	0.46	(509)	0.196	0.56	0.206	No int.	0.103	0	0	0	0	0	0	0	0	0
Span Girder B_4	14.000	Fund ULS Vmin	4	1	0.37	(368)	0.018	0.43	0.019	No int.	0.04	0	0	0	0	0	0	0	0	0
Per Girder_48_1	28.000	Fund ULS Mmax	1	3	1.61	(182)	0.775	0.422	0.71	0.422	No int.	0.377	0	0	0	0	0	0	0	0
Per Girder_48_1	28.000	Fund ULS Mmin	1	3	1.173	(133)	0.523	0.148	0.16	0.148	No int.	0.096	0	0	0	0	0	0	0	0

Fatigue combination														Characteristic SLS combination							
Section	X (m)	Combination	Stds	Stds	Stds	Range	Range	Wch	Wch	Wch	Wch	Wch	Wch	Wch	Wch	Wch	Wch	Wch	Wch	Wch	
			Bst1	Bst2	Bst3	(kN/m)	(kN/m)	(kN/m)	(kN/m)	(kN/m)	(kN/m)	(kN/m)	(kN/m)	(kN/m)	(kN/m)	(kN/m)	(kN/m)	(kN/m)	(kN/m)	(kN/m)	
Span Girder B_41_1	10.500	Fatigue SLS Mmax	0	0.388	0.76	0.632	0.670	0.000	0.775	0.822	0.872	0.682	0.955	0.941	0.955	--	--	--	--	--	--
Span Girder B_41_1	10.500	Fatigue SLS Mmin	0	0.388	0.76	0.632	0.670	0.000	0.775	0.822	0.872	0.682	0.955	0.941	0.955	--	--	--	--	--	--
Span Girder B_41_1	10.500	Fatigue SLS Vmax	0.206	0.201	0.313	0.129	0.137	0.300	0.158	0.167	0.137	0.139	0.194	0.192	0.194	--	--	--	--	--	--
Span Girder B_41_1	10.500	Fatigue SLS Vmin	0.206	0.201	0.313	0.129	0.137	0.300	0.158	0.167	0.137	0.139	0.194	0.192	0.194	--	--	--	--	--	--
Span Girder B_41_11	14.000	Fatigue SLS Mmax	0.044	1.038	0.832	0.665	0.709	0.063	0.815	0.864	0.707	0.717	1.004	0.990	1.004	--	--	--	--	--	--
Span Girder B_41_11	14.000	Fatigue SLS Mmin	0.044	1.038	0.832	0.665	0.709	0.063	0.815	0.864	0.707	0.717	1.004	0.990	1.004	--	--	--	--	--	--
Span Girder B_41_11	14.000	Fatigue SLS Vmax	0.206	0.356	0.433	0.228	0.242	0.300	0.280	0.297	0.243	0.246	0.345	0.340	0.345	--	--	--	--	--	--
Span Girder B_41_11	14.000	Fatigue SLS Vmin	0.206	0.356	0.433	0.228	0.242	0.300	0.280	0.297	0.243	0.246	0.345	0.340	0.345	--	--	--	--	--	--
Per Girder_48_1	28.000	Fatigue SLS Mmax	0.227	0.179	0.312	0.115	0.154	0.153	0.141	0.189	0.117	0.105	0.218	0.154	0.218	--	--	--	--	--	--
Per Girder_48_1	28.000	Fatigue SLS Mmin	0.227	0.179	0.312	0.115	0.154	0.153	0.141	0.189	0.117	0.105	0.218	0.154	0.218	--	--	--	--	--	--
Per Girder_48_1	28.000	Fatigue SLS Vmax	0.267	0.167	0.334	0.107	0.144	0.181	0.131	0.176	0.109	0.145	0.203	0.152	0.203	--	--	--	--	--	--
Per Girder_48_1	28.000	Fatigue SLS Vmin	0.267	0.168	0.335	0.108	0.144	0.181	0.132	0.177	0.110	0.146	0.204	0.154	0.204	--	--	--	--	--	--
Per Girder_48_11	30.950	Fatigue SLS Mmax	0.233	0.202	0.334	0.129	0.174	0.157	0.159	0.213	0.132	0.175	0.245	0.185	0.245	--	--	--	--	--	--
Per Girder_48_11	30.950	Fatigue SLS Mmin	0.233	0.203	0.335	0.129	0.174	0.157	0.160	0.213	0.132	0.175	0.245	0.185	0.245	--	--	--	--	--	--
Per Girder_48_11	30.950	Fatigue SLS Vmax	0.267	0.905	0.21	0.903	0.042	0.181	0.004	0.952	0.902	0.044	0.062	0.003	0.062	--	--	--	--	--	--
Per Girder_48_11	30.950	Fatigue SLS Vmin	0.267	0.907	0.25	0.936	0.049	0.181	0.045	0.960	0.937	0.049	0.069	0.052	0.069	--	--	--	--	--	--

Frequent SLS combination														
Section	X (m)	Combination	Wch	Wch	Wch	Wch	Wch	Wch	Wch	Wch	Wch	Wch	Wch	Wch
			(kN/m)	(kN/m)	(kN/m)	(kN/m)	(kN/m)	(kN/m)	(kN/m)	(kN/m)	(kN/m)	(kN/m)	(kN/m)	(kN/m)
Span Girder B_4	10.500	Freq. SLS Mmax	0.229	--	--	--	--	--	--	--	--	--	--	--
Span Girder B_4	10.500	Freq. SLS Mmin	0.268	--	--	--	--	--	--	--	--	--	--	--
Span Girder B_4	10.500	Freq. SLS Vmax	0.236	--	--	--	--	--	--	--	--	--	--	--
Span Girder B_4	10.500	Freq. SLS Vmin	0.234	--	--	--	--	--	--	--	--	--	--	--
Span Girder B_4	14.000	Freq. SLS Mmax	0.195	--	--	--	--	--	--	--	--	--	--	--
Span Girder B_4	14.000	Freq. SLS Mmin	0.239	--	--	--	--	--	--	--	--	--	--	--
Span Girder B_4	14.000	Freq. SLS Vmax	0.202	--	--	--	--	--	--	--	--	--	--	--
Span Girder_48_1	28.000	Freq. SLS Mmax	0.162	--	--	--	--	--	--	--	--	--	--	--
Span Girder_48_1	28.000	Freq. SLS Mmin	0.096	--	--	--	--	--	--	--	--	--	--	--
Span Girder_48_1	28.000	Freq. SLS Vmax	0.096	--	--	--	--	--	--	--	--	--	--	--
Span Girder_48_1	28.000	Freq. SLS Vmin	0.182	--	--	--	--	--	--	--	--	--	--	--
Span Girder_48_11	30.950	Freq. SLS Mmax	0.129	--	--	--	--	--	--	--	--	--	--	--
Span Girder_48_11	30.950	Freq. SLS Mmin	0.091	--	--	--	--	--	--	--	--	--	--	--
Span Girder_48_11	30.950	Freq. SLS Vmax	0.091	--	--	--	--	--	--	--	--	--	--	--
Span Girder_48_11	30.950	Freq. SLS Vmin	0.165	--	--	--	--	--	--	--	--	--	--	--

It can then be seen that with the modified fatigue combination all sections pass ULS, SLS and Fatigue checks (with the exception of Span Girder B_41_11 – which just exceeds unity).

Obtaining more detailed results

- With the optimised data still loaded, select the **Window> Results** menu item.
- In the ‘Cross-sections and design combinations’ panel, select section **Span Girder B_41_1** and **Fund. ULS, Mmin**.
- Select the **Stresses** tab to have a look at the elastic stresses on the gross section.
- Then, select the **Plastic check** tab. From this, all details about the classification and plastic check are supplied, and it can be seen that for Stage 3, this section, that is part of the segment in the middle of the span, is in Class 1.

Cross-sections and design combinations

Span Girder B_41_1
Span Girder B_41_1
Pier Girder_48_1
Pier Girder_48_11

Fund. ULS. Mmax
Fund. ULS. Mmin
Fund. ULS. Vmax
Fund. ULS. Vmin
Char. SLS. Mmax
Char. SLS. Mmin
Char. SLS. Vmax
Char. SLS. Vmin
Freq. SLS. Mmax
Freq. SLS. Mmin
Freq. SLS. Vmax
Freq. SLS. Vmin
FLS steel. Mmax
FLS steel. Mmin

Forces and Moments

Phase	N	V	M	T
1	0.00E+000	6.70E+004	-1.80E+006	-7.56E-015
2a	0.00E+000	1.69E+004	-5.90E+005	3.82E-011
2b	0.00E+000	-1.10E+004	-1.16E+005	-2.07E-011
Rt. Iso	-4.20E+006	0.00E+000	-1.48E+006	0.00E+000
2c	0.00E+000	0.00E+000	0.00E+000	0.00E+000
3a	-1.77E-007	2.78E+004	2.92E+005	1.19E-011
DT. Iso	3.03E+006	0.00E+000	-5.97E+005	0.00E+000
3b	0.00E+000	1.81E+005	-5.19E+006	-3.60E+003
Totale	-7.23E+006	2.81E+005	-9.48E+006	-3.60E+003

Primary effects of Shrinkage and Thermal action

	g	N	M	γ _v
Shrinkage	-3.308E-4	-4.2E+6	-1.48E+6	1
Thermal var.	1E-4	3.26E+6	6.42E+5	-0.93

Additional bending moment induced by neutral axis shift

	Phase 1	Phase 2a	Phase 2b	Phase 2c	Phase 3a	Phase 3b
Cracked	0E+00	0E+00	0E+00	0E+00	0E+00	0E+00
Uncracked	0E+00	0E+00	0E+00	0E+00	0E+00	0E+00

Plastic check | Stresses | Shear | Geometric properties 0 | Geometric properties 1 | Geometric properties 2 | Domains Mp/N | Studs. ULS. SLS | SLS. Web Breathing | FLS steel | FLS bars | Stiffeners

Determining Class and Plastic verification at Stage 3

	c/t	z _p (mm)	α	v	Class
Web	85.42	1158	-0.08	-1.29	1
Upper flange	9.76				1
Lower flange	4.88				1
Cross-section class					1

=> Plastic verification APPLICABLE

Axial force N	Bending moment M	N-M Interaction			
NEd	-7.23E+6	MEd	-9.48E+6	NEd	-7.23E+6
NRd	-4.22E+7	MRd	-1.51E+7	MEd	-9.48E+6
			MRd		-1.59E+7
NEd/NRd	0.171	MEd/MRd	0.629	MEd/MR	0.596

=> Plastic check PASSED

Phase 1: Upper flange class=3, Web class =4, Lower flange class=1

PLASTIC STRESSES



Note. At the bottom-left of the Plastic check page the section classification is also provided for Phase 1, where the top (upper) flange cannot be considered to be restrained by the slab. For this case, the section is in Class 4 as highlighted in the red message. For this situation a check of stresses in Phase 1 should be performed, using an effective section rather than a gross section.

Creating Graphs

- In PontiEC4, with the optimized data still loaded, select the **Utilities> Graphs** menu item.
- From the first drop-down list choose **ULS: Studs utilization ratio** to plot the following graph:

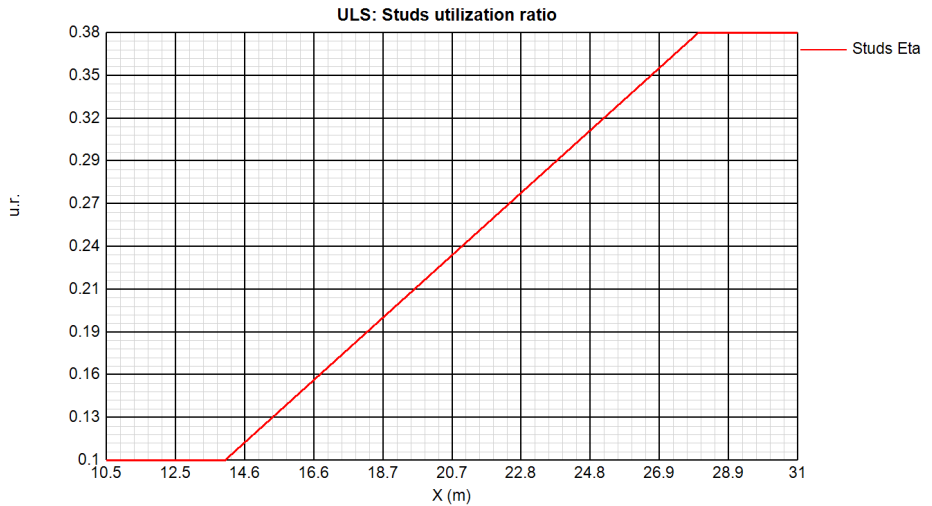

Note. In this example the graph is only being drawn over part of the length of the girder because segment **Span Girder A** was deleted as it has no design section in it. If all segments had been left in, the graph would be across the whole girder.

Creating Reports

- In PontiEC4, with the optimized data still loaded, select the **Window > 6 Report** menu item.
- For section **Span Girder B_41_1** check (tick) to select all optional design checks, and then select the **Create report** button at the bottom-right corner of dialog.

Main report Other reports Settings										
Section	General data	Domain	Classific.	ULS checks (Mmax)	ULS checks (Mmin)	ULS checks (Vmax)	ULS checks (Vmin)	Studs: elastic calculation (Mmax)	Studs: elastic calculation (Mmin)	
Span Girder B_41_1	<input checked="" type="checkbox"/>	<input checked="" type="checkbox"/>	<input checked="" type="checkbox"/>	<input checked="" type="checkbox"/>	<input checked="" type="checkbox"/>	<input checked="" type="checkbox"/>	<input checked="" type="checkbox"/>	<input checked="" type="checkbox"/>	<input checked="" type="checkbox"/>	
Span Girder B_41_11	<input type="checkbox"/>	<input type="checkbox"/>	<input type="checkbox"/>	<input type="checkbox"/>	<input type="checkbox"/>	<input type="checkbox"/>	<input type="checkbox"/>	<input type="checkbox"/>	<input type="checkbox"/>	
Pier Girder_48_1	<input type="checkbox"/>	<input type="checkbox"/>	<input type="checkbox"/>	<input type="checkbox"/>	<input type="checkbox"/>	<input type="checkbox"/>	<input type="checkbox"/>	<input type="checkbox"/>	<input type="checkbox"/>	
Pier Girder_48_11	<input type="checkbox"/>	<input type="checkbox"/>	<input type="checkbox"/>	<input type="checkbox"/>	<input type="checkbox"/>	<input type="checkbox"/>	<input type="checkbox"/>	<input type="checkbox"/>	<input type="checkbox"/>	

- Enter a suitable file name for the report in this case **Span Girder B**, and then press the **Save** button to create the report.

This completes the example.

