

A nighttime photograph of a city skyline with a complex highway interchange in the foreground. The buildings are illuminated with various lights, and the highway shows long-exposure light trails from cars. The sky is dark with some clouds.

# LUSAS

IMD Plus  
User Manual



# **IMDPlus User Manual**

---

**LUSAS Version 19.0 : Issue 1**

LUSAS  
Forge House, 66 High Street, Kingston upon Thames,  
Surrey, KT1 1HN, United Kingdom

Tel: +44 (0)20 8541 1999  
Fax +44 (0)20 8549 9399  
Email: [info@lusas.com](mailto:info@lusas.com)  
<http://www.lusas.com>

Distributors Worldwide

Copyright ©1982-2020 LUSAS  
All Rights Reserved.

## Table of Contents

<b>IMDPlus Assumptions .....</b>	<b>2</b>
<b>Performing IMDPlus Calculations in LUSAS.....</b>	<b>3</b>
Seismic Analysis .....	3
Moving Load Analysis .....	3
Moving Mass Analysis.....	3
<b>IMDPlus Toolbar.....</b>	<b>4</b>
<b>Seismic Analysis.....</b>	<b>6</b>
Earthquake Input.....	7
Mode / Damping Control .....	7
Frequency Interpolation.....	8
<b>Moving Load Analysis .....</b>	<b>10</b>
Moving Load Generation .....	11
Modal Force Calculator.....	17
Running the Moving Load Analysis.....	18
<b>Moving Mass Analysis.....</b>	<b>22</b>
Spring-Mass System Properties.....	24
Moving Mass Vehicle Configuration .....	29
Moving Load Generation .....	30
Modal Force Calculator.....	34
Running the Moving Mass Analysis .....	35
<b>Visualising the Results.....</b>	<b>43</b>
Node / Element Selection .....	46
Spring-Mass System Selection (Moving Mass Only).....	48
Output Control .....	50
<b>Elements Supported By IMDPlus.....</b>	<b>57</b>
<b>Worked examples .....</b>	<b>58</b>



---

# IMDPlus User Manual

The IMDPlus modal dynamics software option calculates the modal response of a system to a given input using calculated eigenmodes and eigenvectors from an eigenvalue analysis. (Note that the eigenvalue analysis must have been performed with mass normalised eigenmodes.)

There are three types of analysis that can be performed in IMDPlus. These are as follows:

**Seismic Analysis**

A seismic analysis obtains the dynamic response of a structure to acceleration time histories of support motion.

**Moving Load Analysis**

A moving load analysis obtains the dynamic response of a structure to moving loads. In a moving load analysis the load can either be explicitly defined or a vehicle configuration (composite axle definition) can be used. In both cases the magnitude and configuration of the load remains constant throughout the analysis.

**Moving Mass Analysis**

A moving mass analysis obtains the dynamic response of a structure to moving masses. In a moving mass analysis spring-mass systems are used in a vehicle configuration. Each spring-mass system includes an unsprung mass and up to two sprung masses connected by springs and viscous dashpots. The configuration of the systems remains constant throughout the analysis but as they move across the structure, the dynamic response of the unsprung and sprung masses affects the forces acting on the underlying structure due to inertia effects.

All solutions from IMDPlus are carried out in the time domain.

## IMDPlus Assumptions

The working assumptions for the IMDPlus modal dynamics facility are as follows:

**Linear**

The system is linear in terms of geometry, material properties and boundary conditions. Therefore geometrically nonlinear eigenvalue results are not applicable. Nor are nonlinear joint and slideline analyses suitable for this type of post-processing treatment.

**No Cross-Coupling**

There is no cross-coupling of modes caused by the damping matrix. This is reasonable for all but the most highly damped structures or applications.

**Low Modes Dominant**

The response is dominated by the lowest few modes.

**Damping Ratios Are Below Critical**

Damping ratios of 100% or more are not permitted due to the solution of the time domain response of the structure using either the Hilber–Hughes-Taylor (HHT) method or Duhamel’s Integral.

**Moving Mass Analysis**

The working assumptions for the particular case of a moving mass analysis are as follows:

**No Loss of Contact**

There is no loss of contact between the unsprung masses (wheels) of the spring–mass systems and the structure at any time during a moving mass analysis.

**Vertical Motion of Spring-Mass Systems Only**

Only vertical motion of the spring-mass systems is considered in a moving mass analysis.

**Mass of Spring-Mass Systems Not Included in Eigenvalue Solution**

The mass of the spring-mass systems have no effect on the natural frequencies of the structure.

**Recommended Limit on Total Mass of Spring-Mass Systems**

The accuracy of the moving mass solution reduces for light-weight structures or structures where the magnitude of the moving mass is similar to the magnitude of the structure mass. A literature search recommends that for most solutions of this type, the total mass of all the spring-mass systems that are actively interacting with the structure at any given time should not exceed 10% of the total mass of the underlying structure.



## Performing IMDPlus Calculations in LUSAS

The various stages of an IMDPlus analysis are initiated from the **Analyses > IMDPlus** menu or the IMDPlus Toolbar. The basic steps that need to be undertaken for each of the three analysis types are as follows:

### Seismic Analysis

1. Select the acceleration time histories
2. Select the eigenmodes to include in the solution
3. Specify the damping for the eigenmodes
4. If required, modify the advanced solution options
5. Specify the frequency interpolation technique and if required, the time step
6. Specify the nodes or elements to process along with the output requirements

### Moving Load Analysis

1. Generate the movement of a discrete load across the structure by using a number of distinct locations along the moving load path
2. Calculate the equivalent modal forces for each of these distinct locations
3. If the loading has not been explicitly defined in step 1, define moving load vehicle configuration(s) using the positions of the axles/bogies that form a vehicle together with the moving load factors to be applied at each position
4. If required, select the moving load vehicle configuration to be used in the analysis
5. Select the eigenmodes to include in the solution
6. Specify the damping for the eigenmodes
7. If required, modify the advanced solution options
8. Specify the speed ranges to analyse along with time stepping parameters
9. Specify the nodes or elements to process along with the output requirements

### Moving Mass Analysis

1. Generate the movement of a discrete unit load across the structure by using a number of distinct locations along the moving load path
2. Calculate the equivalent modal forces for each of these distinct locations
3. Define spring-mass system property attribute(s)
4. Define moving mass vehicle configuration(s) using the positions of the axles/bogies that form a vehicle together with the spring-mass system property attribute that is to be used at each position
5. Select the moving mass vehicle configuration to be used in the analysis

6. If required, include a path surface profile that defines the surface irregularities along the length of the moving load path
7. Select the eigenmodes to include in the solution
8. Specify the damping for the eigenmodes
9. If required, modify the advanced solution options
10. If required, modify the path surface profile options
11. Specify the speed ranges to analyse along with time stepping parameters
12. Specify the nodes, elements or spring-mass systems to process and the output requirements

## IMDPlus Toolbar

All of the IMDPlus dialogs can be launched from the **Analyses > IMDPlus** menu. Alternatively, the IMDPlus Toolbar can be activated from the **View > Toolbars...** menu, as shown in the following figure.

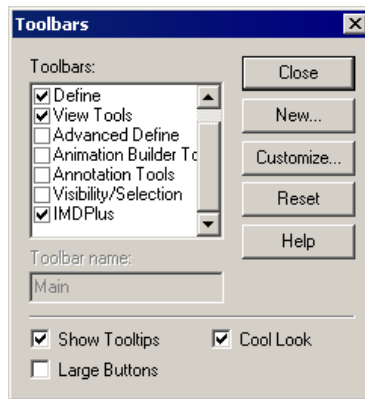

The Toolbar has been split into four sections as follows:

### Analysis Type

This section allows the IMDPlus analysis type to be selected. Options available are as follows:



**Seismic Analysis**



**Moving Load Analysis**



**Moving Mass Analysis**

Only one of the analysis types can be selected at any time.

**IMDPlus Vehicle Attributes**

This section allows IMDPlus attributes to be defined prior to an IMDPlus analysis. Options available are as follows:



**Spring-Mass System Properties**

This button opens the spring-mass system properties dialog. It is only available when the analysis type is set to moving mass.



**Vehicle Configurations**

This button opens either the moving load or moving mass vehicle configuration dialog. The dialog launched depends on the analysis type selected. The button is only available when the analysis type is set to moving load or moving mass.

**Moving Load Generation and Modal Force Calculator**

This section allows the preliminary steps for a moving load or moving mass analysis to be performed. These are the generation of the moving load path and the calculation of the modal force history for use in the IMDPlus analysis, as follows:



**Moving Load Generation**

This button opens the moving load generation dialog. It is only available when the analysis type is set to moving load or moving mass.



**Modal Force Calculator**

This button opens the modal force calculator dialog. It is only available when the analysis type is set to moving load or moving mass and the moving load generation step has already been carried out.

**Running an IMDPlus Analysis**

This section allows an IMDPlus analysis to be performed. Options available to the user are as follows.



**Analysis Control**

This button opens either the seismic, moving load or moving mass analysis control dialog. The dialog launched depends upon the analysis type selected. For both moving load and moving mass analysis types the button is only available when the modal force calculation has been carried out.





### Output Control

This button opens either the seismic, moving load or moving mass output control dialog. The dialog launched depends upon the analysis type selected. It is only available when an IMDPlus analysis has been carried out and results are still available on disk for graphing.

## Seismic Analysis

The seismic analysis option calculates the response of the structure to an acceleration time history applied at the support nodes. Both 2D and 3D structures can be analysed but they are restricted to having the acceleration inputs applied in the global X-, Y- directions and X-, Y- and Z-directions respectively. Only one acceleration time history can be specified for each excitation direction and therefore, all support nodes are accelerated with the same time history record in this direction. Different acceleration records can be applied to each global direction and these can be factored based on design code requirements. Up to seven earthquake combinations can be analysed in a single IMDPlus analysis.

The IMDPlus seismic analysis control dialog is accessed from the **Analyses > IMDPlus > Seismic...** menu or from the IMDPlus Toolbar. Ensure the  button is selected to choose a seismic analysis and then select the  button to launch the seismic analysis control dialog.

**IMDPlus Seismic Analysis Control**

Earthquake input

X-direction earthquake record(s)  Browse...

Y-direction earthquake record(s)  Browse...

Z-direction earthquake record(s)  Browse...

Direction Factors X  Y  Z

Mode/damping control

Included modes:  Modify...

Default damping  % Modify...

Total participating mass

X Direction	94.56	%
Y Direction	93.84	%
Z Direction	31.22	%

Frequency interpolation

Advanced solution options  Modify...

All frequencies included  Linear interpolation of records

Limit frequencies to Nyquist frequency  Cubic spline interpolation of records

Time step

< Back Next > Cancel Help

## Earthquake Input

For two-dimensional structures, earthquake acceleration time history records can be applied in the global X- and Y-directions. For three-dimensional structures, an additional earthquake acceleration component in the global Z-direction can be applied. Permissible input formats for these acceleration records are space delimited, TAB delimited or Comma Separated Variable (CSV).

For all of these input formats, the time step of the acceleration records must be identical in all of the earthquake acceleration files. IMDPlus supports the solution of up to seven earthquakes at a time with enveloping / averaging of the Secondary Response Spectra (SRS). For space or TAB delimited files the number of time steps in each directional record for multiple record files must be identical across each of the earthquakes. For Comma Separated Variable files, the number of time steps in each directional record can vary but the number of time steps in individual earthquakes must be identical. If more than one earthquake is present in the record files, the IMDPlus analysis will process all valid combinations.

### Sample Acceleration Time History Records

#### Space Delimited Single Combination

```
0.000 0.0000E+000
0.005 -2.7459E-002
0.010 -3.4127E-002
0.015 -4.0796E-002
0.020 -4.7464E-002
0.025 -5.4133E-002
```

#### Space Delimited Two Combinations

```
0.000 0.0000E+000 0.0000E+000
0.005 -2.7459E-002 -4.0070E-005
0.010 -3.4127E-002 8.2210E-004
0.015 -4.0796E-002 1.2618E-002
0.020 -4.7464E-002 1.4741E-002
0.025 -5.4133E-002 1.8604E-002
```

## Mode / Damping Control

The modes to include in the analysis can be controlled either by the eigenmodes solved in the eigenvalue analysis or a subset defined in the mode control. The default option when first running an analysis is for all modes to be included in the analysis but individual modes can be included or excluded using the following dialog accessed via the **Modify...** button on the seismic analysis control dialog.

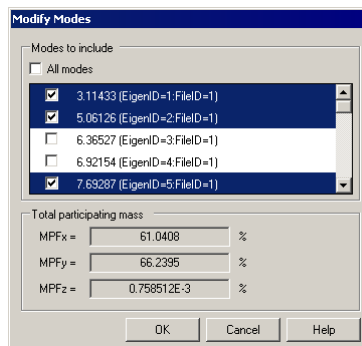

This dialog also calculates the total participating mass for the included modes. If a significant proportion of participating mass is missing, based on the selected modes of vibration, a warning will be issued when proceeding with the analysis. Omission of modes of vibration with significant mass contributions that can be excited by the input acceleration time histories will lead to unreliable solutions. Ideally, total mass participations in excess of 90% should be used unless it is guaranteed that the modes of vibration associated with any missing mass are at frequencies that cannot be excited.

The Default damping option allows the user to control the amount of damping used in the IMDPlus analysis. If Default damping is selected, all of the modes of vibration included in the analysis are forced to have the current default value. The default value is set, via the **Modify...** button on the seismic analysis control dialog.

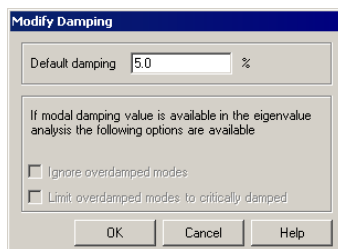

The Default damping option can only be turned off when viscous damping has been included in the eigenvalue analysis. If Default damping is deselected the viscous damping present in the eigenvalue analysis is used in the IMDPlus analysis. When viscous damping is included in the eigenvalue solution additional options for the inclusion of overdamped modes of vibration in the IMDPlus analysis also become available. These options are as follows:

**Ignore overdamped modes**

Modes of vibration with a damping ratio of 100% or more are omitted from the IMDPlus solution.

**Limit overdamped modes to critically damped**

Modes of vibration with a damping ratio of 100% or more are limited to 99.9999% to allow them to be included in the analysis.

## Frequency Interpolation

Four interpolation options are available for the interpretation of the acceleration time histories in IMDPlus. These are as follows:

**All frequencies included**

All modes of vibration are included in the analysis even if their frequencies are greater than the maximum frequency that may be reliably resolved based on the acceleration time history time step (the Nyquist frequency).

**Limit frequencies to Nyquist frequency**

All modes of vibration up to and including the Nyquist frequency are included in the analysis. Modes of vibration with frequencies in excess of this value are discarded.

**Linear interpolation of records**

Allows for linear interpolation of the earthquake records. The required time step is specified by the user for the analysis.

**Cubic spline interpolation of records**

Allows for cubic spline interpolation of the earthquake records. The required time step is specified by the user for the analysis.



**Note.** For rapidly varying input acceleration time histories, such as real acceleration records measured on site that often have large reversals in acceleration over one or two time steps, the cubic spline interpolation should generally not be used. For synthetic acceleration time history records, the use of cubic spline interpolation is usually valid since the Fourier series used to generate the synthetic records tend to produce smoother responses. It is however up to the user to ensure that the method of interpolation used is suitable for the analysis being carried out.



**Note.** The Nyquist frequency is equal to  $1/(2*\delta t)$  where  $\delta t$  is the time step of the acceleration time history.

**Advanced Seismic Solution Options**

Advanced solution options can be set via the **Modify...** button on the seismic analysis control dialog.

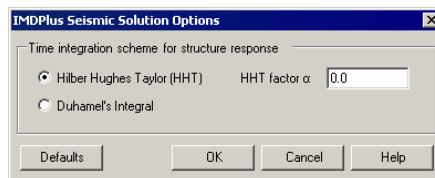

The options available in a seismic analysis are as follows. The **Defaults** button resets all of the options to the default values.

**Time integration scheme for structure response**

The implicit time integration scheme used by IMDPlus to calculate the dynamic response of the structure.

**Hilber Hughes Taylor (HHT)**

This is the default time integration scheme and is the same as the method used for an implicit transient dynamic analysis in LUSAS.

**□ HHT factor  $\alpha$** 

The integration constant  $\alpha$  used in the HHT integration scheme. For an unconditionally stable, second order accurate scheme,  $\alpha$  must lie between the limits  $-1/3 \leq \alpha \leq 0.0$ . Values of  $\alpha$  outside this range cannot be specified. The default value of  $\alpha$  is 0.0, which reduces the method to the Newmark method. Further integration constants  $\beta$  and  $\gamma$  are computed automatically by IMDPlus using the following equations:

$$\beta = (1 - \alpha)^2 / 4 \quad , \quad \gamma = (1 - 2\alpha) / 2$$

**□ Duhamel's Integral**

This is the time integration method used by IMDPlus in LUSAS 14.7 (and earlier versions of LUSAS) and is available as an alternative to the HHT integration scheme.

## Moving Load Analysis

The moving load analysis option obtains the dynamic response of the structure to the passage of a moving load along a user defined path. Both 2D and 3D structures can be analysed and the magnitude and configuration of the load remains constant throughout the entire analysis. Two methods are available for the definition of the moving load configuration. These are:

**□ Explicit definition**

The complete load configuration is defined through a discrete load definition in Modeller. This can be used for analysing the passage of a single load configuration across the structure.

**□ Composite axle definition**

The complete load configuration consists of a unit load single axle configuration, defined as a discrete load definition in Modeller, and a vehicle configuration is that is defined separately. The vehicle configuration (composite axle definition) method is the recommended approach, as it allows multiple load configurations (such as multiple train rolling stock configurations) to be analysed rapidly without having to repeat initial steps for the IMDPlus solution.

Irrespective of the method used, two distinct steps are required to prepare the moving load input data for IMDPlus. These two steps are as follows:

1. Generation of the moving load path across the structure
2. Calculation of equivalent modal forces for the moving load path





**Note.** These two steps must be carried out before the first analysis but may be omitted from subsequent analyses, if and only if the moving load path, discrete load configuration and direction of the moving load do not change between analyses. If any of these are modified the moving load path and calculation of equivalent modal forces must be carried out again.

## Moving Load Generation

The moving load generator is used to mimic the passage of a load across a structure by automatically setting up a number of static load cases at prescribed locations along a single line/arc/spline, or a collection of lines/arcs/splines, which define a single continuous path. These load cases can then be used to calculate the modal forces equivalent to the applied loading for import into IMDPlus. Before entering the moving load generator, the lines/arcs/splines defining the path must be selected and a discrete load representing the load configuration that is to be moved across the structure must have been defined.

The definition requirements for this discrete load are governed by the type of moving load input that is going to be used in IMDPlus. If the discrete load is going to represent the whole load configuration (i.e. a vehicle configuration is not being used) then it must contain all of the loading associated with the configuration. However, if the composite axle definition method is being used in IMDPlus, this discrete load should represent a subset of the overall load configuration and will be used along with the vehicle configuration to build up the total load configuration in IMDPlus.

### Explicit Definition of United Kingdom HB Vehicle

For the LUSAS Bridge option, HB vehicles can be defined from the **Bridge > Bridge Loading > United Kingdom...** menu entry.

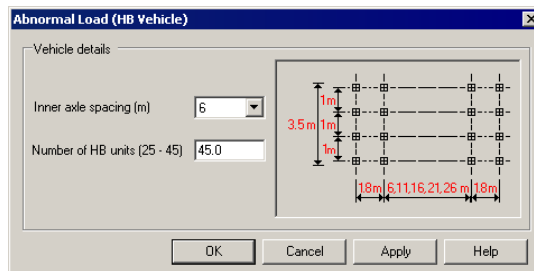

After defining a vehicle load, either the initial definition dialog (as shown above) or the resulting attribute data can be viewed. This is done by right-clicking on the Attribute name in the Attributes Treeview and selecting either the **Edit Definition** or **Edit Attribute** menu item. Selecting the latter will show the following discrete point load data for the above vehicle selection.

	X	Y	Z	Load
1	-4.8	-1.5	0.0	-112.5E3
2	-3.0	-1.5	0.0	-112.5E3
3	3.0	-1.5	0.0	-112.5E3
4	4.8	-1.5	0.0	-112.5E3
5	-4.8	-0.5	0.0	-112.5E3
6	-3.0	-0.5	0.0	-112.5E3
7	3.0	-0.5	0.0	-112.5E3
8	4.8	-0.5	0.0	-112.5E3
9	-4.8	0.5	0.0	-112.5E3
10	-3.0	0.5	0.0	-112.5E3

This discrete point load can now be used to define the passage of the HB vehicle across the structure.





**Note.** The front of the moving load is always the location with the maximum discrete load X co-ordinate.

### Composite Axle Definition of United Kingdom HB Vehicle using a Moving Load Vehicle Configuration

The equivalent composite axle definition of the above HB vehicle can be achieved by defining a unit axle of the across carriageway configuration and defining the vehicle configuration separately. The following discrete point load defines the unit axle for the HB vehicle.

	X	Y	Z	Load
1	0	-1.5	0	-0.25
2	0	-0.5	0	-0.25
3	0	0.5	0	-0.25
4	0	1.5	0	-0.25

The IMDPlus moving load vehicle configuration dialog is used to create or modify vehicle configuration attributes for use in a moving load analysis. It is accessed from the **Analyses > IMDPlus > Moving Load > Vehicle Configuration...** menu or from the IMDPlus Toolbar. Ensure the  button is selected to choose a moving load analysis and then select the  button to launch the moving load vehicle configuration dialog.

In a moving load vehicle configuration the position (relative to the origin / front of the vehicle) of each of the applied loads is defined along with the value of the moving load factor to be applied at each position. For the United Kingdom HB vehicle the axle positions and load factors shown in the following figure data should be entered into the dialog. A meaningful name should be entered into the Name field, for example, 45Unit\_HB\_Axles.

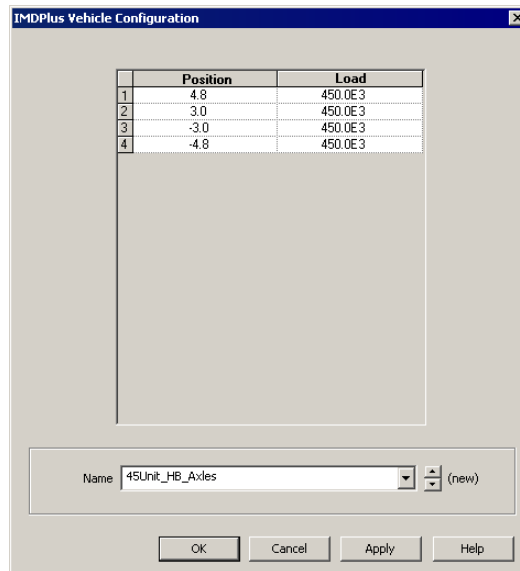

**Note.** Care should be taken when defining axle positions (X co-ordinates) in discrete load configurations. The path length should be sufficiently longer than the structure to ensure that the load configuration correctly arrives onto and departs from the structure. In the above example, the path should start at least 4.8 m before the structure and finish 4.8 m after the structure.



**Note.** The front of the moving load vehicle is always the position with the maximum co-ordinate. The rear of the vehicle is always the position with the minimum co-ordinate.



**Note.** The positions and loads that define the vehicle configuration can be copied and pasted from a Microsoft Excel spreadsheet. This method is demonstrated in the IMDPlus Worked Example: Train Induced Vibration of a Bridge.





**Note.** Once created vehicle configurations will appear in the Utilities Treeview, from where they can be modified or deleted from the model. To modify a vehicle configuration either double-click or right-click on the Attribute name in the Utilities Treeview and select the **Edit Attribute...** menu item.



**Note.** Vehicle configurations can be easily transferred from one model to another using an attribute library file, accessed from the menu **File > Import/Export model data...**

## Generation of the Moving Load Discrete Locations

If a valid continuous path has been selected and a valid discrete load defined then the moving load generator can be used to create the static load cases at prescribed locations along the path.

The IMDPlus moving load generation dialog is accessed from the **Analyses > IMDPlus > Moving Load > Moving Load Generation...** menu or from the IMDPlus Toolbar. Ensure the  button is selected to choose a moving load analysis and then select the  button to launch the moving load generation dialog.

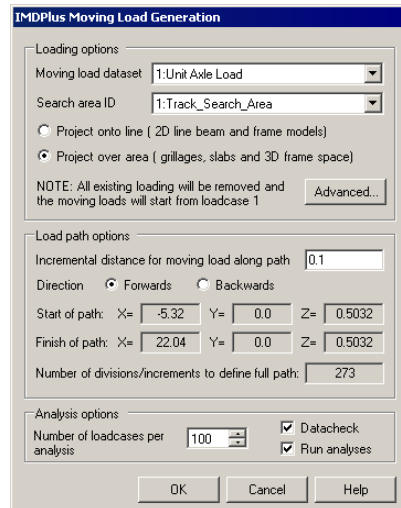

If a search area has been defined then this can be used to correctly assign the moving load if there are multiple planes to which the discrete load could be assigned. **Project onto line** or **Project over area** can be selected depending upon the geometry defining the search area. For single deck models, the default search area which encompasses the whole structure can be used. Parameters for the inclusion of the load can be accessed through the **Advanced...** button which provides the full application options available for discrete loads. These options consist of the inclusion of loads outside the search area and the load factor to be applied.

Having defined the loading options, the load path options can be set based on the lines/arcs/splines selected to define the path. The incremental distance controls the separation of the discrete load locations used to define the passage of the load across the structure. This incremental distance should be positive and sufficiently small to capture the movement of the load.



**Note.** Due to the dynamic solution a sufficiently small distance should be used between the discrete locations defining the passage of the load to minimise oversampling for load locations between those defined. For static analyses, much larger distance increments can be used since the incremental movement does not need to be close to the time step of the analysis.

Ideally, the distance increment used for the movement of the load along the path should obey the following equation:

$$\delta\text{Dist} \leq 10 \times \text{Minimum Speed} \times \delta t$$

to give a maximum oversample of 10.  $\delta t$  is the minimum of the Nyquist time step and any user specified time step ( $\delta t^{\text{Nyquist}} = 1/(2 * f_{\text{max}})$  where  $f_{\text{max}}$  is the maximum frequency included in the analysis). Larger distance increments can be used but warnings will be issued by IMDPlus since the accuracy of the dynamic solution decreases with increasing oversampling ratio. Oversampling ratio reduces with increasing speed and therefore it is possible that higher oversampling ratios can be used for lower speeds where the dynamic excitation is reduced. It is however up to the user to ensure that use of higher oversampling ratios for any speed does not adversely affect the solutions to the dynamic analysis.

The moving load path forwards direction is defined by the order of selection of the lines, arcs or splines. The path starts at the first line that is connected to only one other selected line. If only a single line is selected, the forwards direction of the moving load path is defined by the line direction defined in Modeller (Line directions can be visualised through the Geometry layer in the Treeview). The direction that the moving load travels can be toggled between forwards and backwards relative to the original line selection for the generation of the discrete locations. The start and end of the path will be displayed along with the number of divisions / increments required for the full description.

The number of load cases per analysis controls the number of load cases for each LUSAS analysis used to obtain the loading information. By default this is set to 100 but can be increased up to 1000. Options are available to perform a datacheck analysis instead of a full static solution. The advantage of using this option is in both speed and the amount of disk space required for the LUSAS analyses. IMDPlus itself only requires the loading vector information from the datacheck analysis but if static solutions are also required for the passage of the moving load this option can be switched off. An option is also available not to run the analyses immediately. By default the LUSAS analyses will be carried out once the OK button has been clicked. If however the user wishes to run a large number of analyses resulting from the moving load definition overnight, this option can be switched off and a batch file generated so the analyses can be run separately. The original model, associated eigenvalue results and static load cases must be loaded prior to proceeding to the next stage of the moving load analysis.

This can be carried out by running the following two VBScript files which will have been generated in the directory \<LUSAS Installation Folder>\Projects\<Model Name>\Associated Model Data\<Model Name>



**IMDPlus\_Model\_Reload.vbs**

Reloads the model and eigenvalue results



**IMDPlus\_LoadVector\_Load.vbs**

Loads the static results on top of the model and eigenvalue





**Note.** If for any reason the model and static load cases need to be loaded for the current moving load path and configuration in the future, these two VBScript files can be used.

**Modal Force Calculator**

The path and configuration of the moving load should have been defined using the moving load generation described previously. The discrete loads at distances along the path now need to be converted into equivalent modal forces for import into IMDPlus. This is carried out using the modal force calculator.

The IMDPlus modal force calculator dialog is accessed from the **Analyses > IMDPlus > Moving Load > Modal Force Calculator...** menu or from the IMDPlus Toolbar.

Ensure the  button is selected to choose a moving load analysis and then select the  button to launch the modal force calculator dialog.

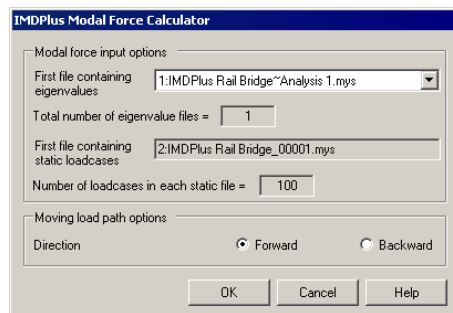

On entry, the eigenvalue and static results will be identified and placed into the dialog. Multiple eigenvalue results files are supported which allows the solution of structures with large numbers of eigenvalues over multiple analyses with frequency / eigenvalue ranges.

The moving load path options allow the user to change the direction of the load movement along the path but this option should not be used unless the load configuration is symmetrical.



**Note.** Once the moving load generation and modal force calculation have been carried out in a moving load analysis, these two steps may be omitted from subsequent analyses, even if the analysis type is switched from moving load to moving mass but only if the moving load path, discrete load configuration and direction of the moving load do not change between analyses. If any of these are modified the moving load path and calculation of equivalent modal forces must be carried out again.

### Running the Moving Load Analysis

An IMDPlus moving load analysis can only be performed if the following steps have already been undertaken:



- The equivalent modal forces have been successfully calculated using the moving load generator and the modal force calculator
- If a composite axle definition is being used at least one moving load vehicle configuration has been defined in the model

The IMDPlus moving load analysis control dialog is shown in the following figure. On entering moving load analysis control for the first time the dialog will be filled with default information shown.

The screenshot shows the 'IMDPlus Moving Load Analysis Control' dialog box. It is divided into three main sections: 'Moving load input', 'Mode/damping control', and 'Solution control'.  
1. **Moving load input:** Contains a checkbox for 'Vehicle configuration (Composite axle)' and a dropdown menu.  
2. **Mode/damping control:** Includes 'Included modes' (set to 'All') and 'Default damping' (set to '5.0 %'). Both have 'Modify...' buttons. To the right, 'Total participating mass' is shown for X-Direction (93.83 %), Y-Direction (94.07 %), and Z-Direction (88.20 %).  
3. **Solution control:** Includes 'Advanced solution options' with 'Minimum speed', 'Maximum speed', and 'Speed increment' fields. It also has 'Quiet time after passage of load' (0.0) and 'Solution time step' fields. A checkbox for 'IMDPlus automatic time step (Nyquist)' is checked. A 'Modify...' button is also present.  
At the bottom, there are four buttons: '< Back', 'Next >', 'Cancel', and 'Help'.

The IMDPlus moving load analysis control dialog is accessed from the **Analyses > IMDPlus > Moving Load > Moving Load Analysis...** menu or from the IMDPlus



Toolbar. Ensure the  button is selected to choose a moving load analysis and then select the  button to launch the moving load analysis control dialog.

### Moving Load Input

If a composite axle definition is being used in the analysis a vehicle configuration can be included by selecting the checkbox marked Vehicle configuration (Composite axle). This will enable the drop-down list that will contain all of the moving load vehicle configurations in the model. The required vehicle configuration can be selected for use in the IMDPlus analysis, as shown by the example in the following figure.

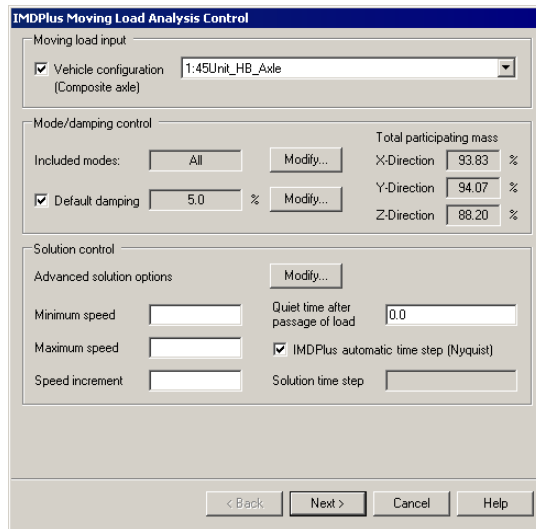

**Note.** Although a vehicle configuration (composite axle definition) is designed for internal construction of complex loading configurations from a single axle, for example defining a complete trainset from a single unit axle, it can also be used to model the passage of more than one load configuration across the structure. Each load configuration is restricted to having the same plan layout but can have different magnitudes governed by the load factors contained in the vehicle configuration.

### Mode / Damping Control

The modes to include in the analysis can be controlled either by the eigenmodes solved in the eigenvalue analysis or a subset defined in the mode control. The default option when first running an analysis is for all modes to be included in the analysis but individual modes can be included or excluded using the following dialog accessed via the **Modify...** button on the moving load analysis dialog.

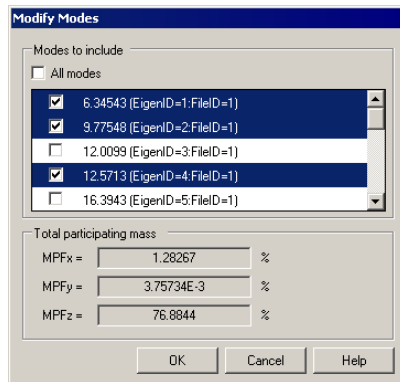

This dialog also calculates the total participating mass for the included modes. If a significant proportion of participating mass is missing based on the selected modes of vibration a warning will be issued when proceeding with the analysis. Omission of modes of vibration with significant mass contributions that can be excited during the analysis will lead to unreliable solutions. Ideally, total mass participations in excess of 90% should be used unless it is guaranteed that the modes of vibration associated with any missing mass are at frequencies that cannot be excited.

The Default damping option allows the user to control the amount of damping used in the IMDPlus analysis. If Default damping is selected, all of the modes of vibration included in the analysis are forced to have the current default value. The default value is set, via the **Modify...** button on the moving load analysis control dialog.

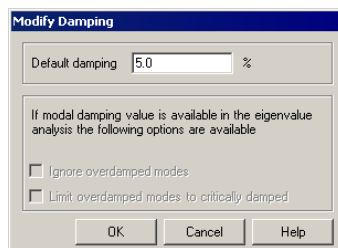

The Default damping option can only be turned off when viscous damping has been included in the eigenvalue analysis. If Default damping is deselected the viscous damping present in the eigenvalue analysis is used in the IMDPlus analysis. When viscous damping is included in the eigenvalue solution additional options for the inclusion of overdamped modes of vibration in the IMDPlus analysis also become available. These options are as follows:

**Ignore overdamped modes**

Modes of vibration with a damping ratio of 100% or more are omitted from the IMDPlus solution.

**❑ Limit overdamped modes to critically damped**

Modes of vibration with a damping ratio of 100% or more are limited to 99.9999% to allow them to be included in the analysis.

**Solution Control**

The speeds and time stepping information are input via the solution control section. The input includes a range of speeds for the solution defined using a minimum speed, maximum speed and a speed increment. If only a minimum or maximum speed is specified then one speed, equal to the value entered, will be analysed for the moving load. A quiet time can be specified which allows for the inclusion of a user defined length of time after the passage of the load along the path. This enables decay of the structural vibration to be analysed. By default, IMDPlus determines the time step required for the analysis from the Nyquist time step. This is calculated from the maximum frequency included in the analysis. User control over the time step for the solution is available by disabling this feature.

**Advanced Moving Load Solution Options**

Advanced solution options can be set via the **Modify...** button on the moving load analysis control dialog.

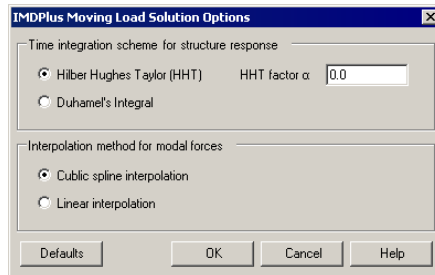

The options available in a moving load analysis are as follows. The **Defaults** button resets all of the options to the default values.

**❑ Time integration scheme for structure response**

The implicit time integration scheme used by IMDPlus to calculate the dynamic response of the structure.

**❑ Hilber Hughes Taylor (HHT)**

This is the default time integration scheme and is the same as the method used for an implicit transient dynamic analysis in LUSAS.

**❑ HHT factor  $\alpha$**

The integration constant  $\alpha$  used in the HHT integration scheme. For an unconditionally stable, second order accurate scheme,  $\alpha$  must lie between the limits  $-1/3 \leq \alpha \leq 0.0$ . Values of  $\alpha$  outside this range cannot be

specified. The default value of  $\alpha$  is 0.0, which reduces the method to the Newmark method. Further integration constants  $\beta$  and  $\gamma$  are computed automatically by IMDPlus using the following equations:

$$\beta = (1 - \alpha)^2 / 4 \quad , \quad \gamma = (1 - 2\alpha) / 2$$

**Duhamel's Integral**

This is the time integration method used by IMDPlus in LUSAS 14.7 (and earlier versions of LUSAS) and is available as an alternative to the HHT integration scheme.

**Interpolation method for modal forces**

The interpolation method used by IMDPlus to calculate the equivalent modal forces from the values obtained at the discrete path locations by the modal force calculator.

**Cubic spline interpolation**

Equivalent modal forces are interpolated using a cubic spline interpolation technique. This is the default option.

**Linear interpolation**

Equivalent modal forces are interpolated using a linear interpolation technique.

## Moving Mass Analysis

The moving mass analysis option obtains the dynamic response of the structure to the passage of moving spring-mass systems along a user defined path. Both 2D and 3D structures can be analysed. The configuration of the spring-mass systems remains constant throughout the analysis but as they move across the structure, the dynamic response of the unsprung and sprung masses affects the forces acting on the underlying structure due to inertia effects.

It is important to note the following working assumptions for the case of a moving mass analysis:

- Only vertical motion of the spring-mass systems is considered
- There is no loss of contact between the unsprung masses (wheels) of the spring-mass systems and the structure at any time
- The mass of the spring-mass systems have no effect on the natural frequencies of the structure
- The accuracy of the moving mass solution reduces for light-weight structures or structures where the magnitude of the moving mass is similar to the magnitude of the structure mass. A literature search recommends that for most solutions of

this type, the total mass of all the spring-mass systems that are actively interacting with the structure at any given time should not exceed 10% of the total mass of the underlying structure.

The following two steps are required to define the moving spring-mass systems that are to be used in the analysis:

1. Define the spring-mass system property attribute(s)
2. Define the moving mass vehicle configuration(s) using the positions of the axles/bogies that form a vehicle together with the spring-mass system property attribute that is to be used at each position

Two further preliminary steps are required, in a similar manner to a moving load analysis, before a moving mass analysis can be undertaken. These generate equivalent modal forces by simulating the movement of a discrete unit load across the structure, using a number of distinct locations along a moving load path. The two steps are as follows:

3. Generation of the moving load path across the structure

A discrete load representing the unit load configuration for the axles/bogies of the vehicle that is to be moved across the structure must be defined. The moving load generator is then used to mimic the path of this unit load across the structure by automatically setting up a number of static load cases at prescribed locations along the path that the vehicle configuration is to follow.

4. Calculation of equivalent modal forces for the moving load path

The static load cases are used to calculate the modal forces equivalent to the applied unit loading for import into IMDPlus. The equivalent modal forces are used in IMDPlus together with the loading from the spring-mass systems of the vehicle to build up the complete loading configuration applied to the structure.



**Note.** Steps 3 and 4 must be carried out before the first analysis but may be omitted from subsequent analyses, if and only if the moving load path, discrete unit load configuration and direction of the moving load do not change between analyses. If any of these are modified the moving load path and calculation of equivalent modal forces must be carried out again.

## Spring-Mass System Properties

A spring-mass system is represented by a single unsprung mass and up to two sprung masses, connected by springs and viscous dashpots, as shown in the following figure. A spring-mass system property attribute defines the masses, linear or nonlinear spring stiffnesses and viscous damping properties for a spring-mass system. Spring-mass system properties are assigned to different initial positions in a moving mass vehicle configuration in order to represent all of the axle/bogie locations of an entire vehicle or trainset. As these systems move across the structure, the motion of the unsprung and sprung masses affects the forces acting on the underlying structure due to inertia effects.



**Note.** A vehicle or trainset may contain several axle/bogie positions with the same spring-mass system properties, that is, masses, spring stiffnesses and viscous damping constants. A spring-mass system property attribute can therefore be assigned to multiple axle/bogie positions when defining a vehicle configuration.

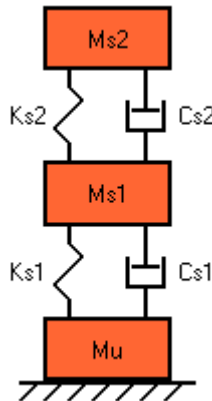

Different spring behaviour can be modelled ranging from a simple linear elastic spring through to more complex nonlinear behaviour. Linear viscous dashpots can be optionally included for each of the sprung masses. Nonlinear spring behaviour allows for the inclusion of the following spring types.

### Piecewise linear springs

Piecewise linear springs can be used to model bilinear springs or more general nonlinear spring behaviour.

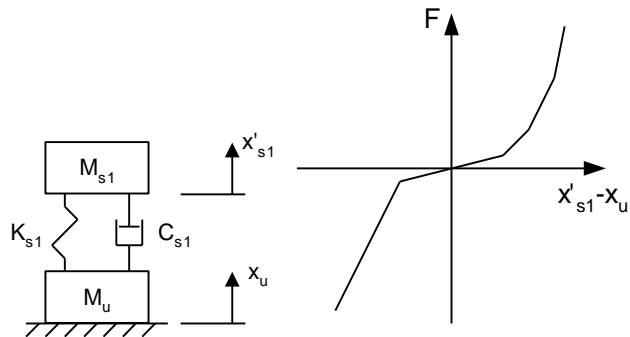

**Piecewise-linear spring: Nonlinear spring behaviour**

Piecewise linear springs can also be used to simulate stopper systems that limit the spring deflections through the inclusion of very high compressive spring stiffnesses after a given closure.

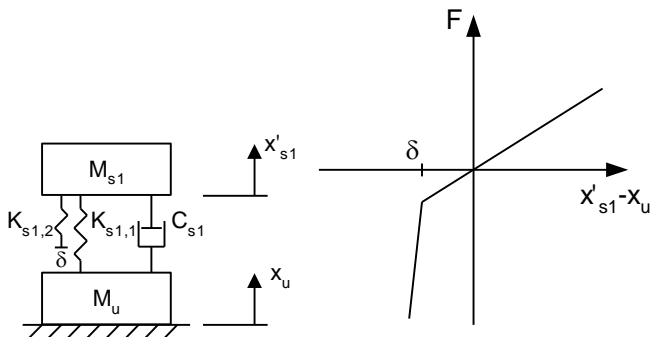

**Piecewise-linear spring: Stopper system to limit deflections**

**Polynomial Springs**

Polynomial springs can be used to represent nonlinear spring behaviour using the following function:

$$F = \sum_{a=1}^N C_a dx^a$$

The total spring force, F, is expressed in terms of the total spring deflection, dx, where N is the order of the polynomial and  $C_a$  are the polynomial constants. This allows for the special cases of rubber springs and ‘C’ springs, as shown in the following figures, along with more general spring definitions.



**Note.** The polynomial function always passes through the origin of the spring force-displacement curve. This ensures that the spring force is zero at zero spring displacement.

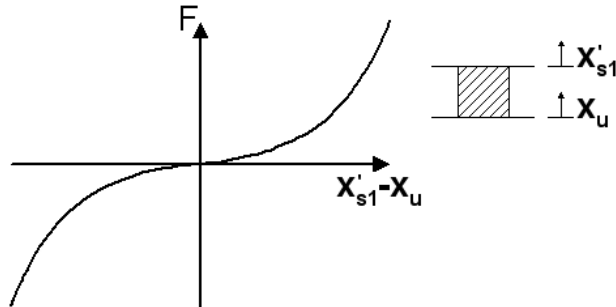

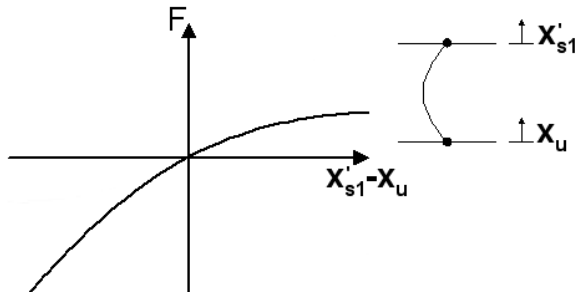

**Polynomial spring: Rubber Spring**  $F = C_1(x'_{s1}-x_u) + C_3(x'_{s1}-x_u)^3$



**Polynomial spring: 'C' Spring**  $F = C_1(x'_{s1}-x_u) + C_2(x'_{s1}-x_u)^2$

### Spring Mass System Properties Dialog

The IMDPlus moving mass spring-mass system properties dialog is used to create or modify spring-mass system property attributes for use in a moving mass analysis. It is accessed from the **Analyses > IMDPlus > Moving Mass > Spring Mass Properties...**

menu or from the IMDPlus Toolbar. Ensure the  button is selected to choose a moving mass analysis and then select the  button to launch the moving mass spring-mass system properties dialog.



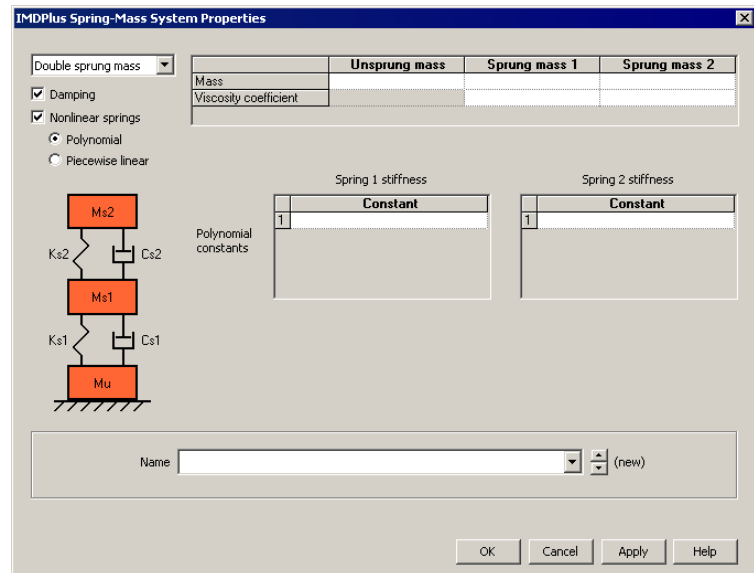

Options for the spring-mass system are located in the upper left hand corner of the dialog. These define the number of sprung masses in the system and allow for the optional inclusion of damping and nonlinear spring behaviour. The number of sprung masses is controlled by selecting one of the following options from the drop-down list.

- Unsprung mass only
- Single sprung mass
- Double sprung mass

On the left hand side of the dialog a diagram of the chosen spring-mass system is displayed. All property data is input on the right hand side of the dialog as follows:

- Unsprung and sprung masses**
  - Unsprung and sprung masses should be defined in the model mass units
  - If required, the unsprung mass can be set to 0.0 for a **Single sprung mass** or **Double sprung mass** system
  - If required, the 1st sprung mass can be set to 0.0 for a **Double sprung mass** system
- Elastic spring stiffness**
  - Elastic spring stiffnesses are only required if **Nonlinear springs** has not been selected
  - Elastic spring stiffnesses should be defined in the model stiffness units

### ❑ **Viscosity coefficient**

- Viscosity coefficients are only required if **Damping** has been selected
- Viscosity coefficients should be defined in the model force\*time/length units
- If required, the viscosity coefficients can be set to 0.0

### ❑ **Nonlinear springs**

If Nonlinear springs is selected the spring behaviour is defined using either polynomial constants or piecewise linear data.

#### ❑ **Polynomial springs**

The spring force-displacement relationship is defined using a polynomial function

- The polynomial constants  $C_a$  should be entered in the table where row 1 defines the linear constant  $C_1$ , row 2 defines the quadratic constant etc.
- The polynomial function must have a positive value at a displacement of 0.0
- At least one of the polynomial constants must be non zero
- IMDPlus requires the spring stiffness to always be a positive value. With higher order functions the gradient of the force-displacement relationship will generally reach a peak and become negative at a limiting compressive and/or tensile displacement. In these cases the IMDPlus analysis will terminate if the spring displacements ever reach these limiting values.

#### ❑ **Piecewise linear springs**

The spring stiffness-deformation relationship is defined using a piecewise linear curve

- Compressive and tensile data is input separately to ensure that the resulting force-displacement curves always pass through the origin

#### ❑ **Stiffness**

- Spring stiffnesses should be defined in the model stiffness units
- Spring stiffnesses must always be defined as a positive value

#### ❑ **Deformation**

- Spring deformations should be defined in the model length units
- The deformation of the first data point (row 1) of each piecewise linear curve must be set to 0.0
- In compression all deformations must be negative and must be monotonically decreasing
- In tension all deformations must be positive and must be monotonically increasing

A meaningful name should be entered into the Name field.





**Note.** Once created spring-mass system properties will appear in the Utilities Treeview, from where they can be modified or deleted from the model. To modify a spring-mass system property either double-click or right-click on the Attribute name in the Utilities Treeview and select the **Edit Attribute...** menu item.



**Note.** Spring-mass system properties can be easily transferred from one model to another using an attribute library file, accessed from the menu **File > Import/Export model data...**

## Moving Mass Vehicle Configuration

The IMDPlus moving mass vehicle configuration dialog is used to create or modify vehicle configuration attributes for use in a moving mass analysis. It is accessed from the **Analyses > IMDPlus > Moving Mass > Vehicle Configuration...** menu or from the IMDPlus Toolbar. Ensure the  button is selected to choose a moving mass analysis and then select the  button to launch the moving mass vehicle configuration dialog.

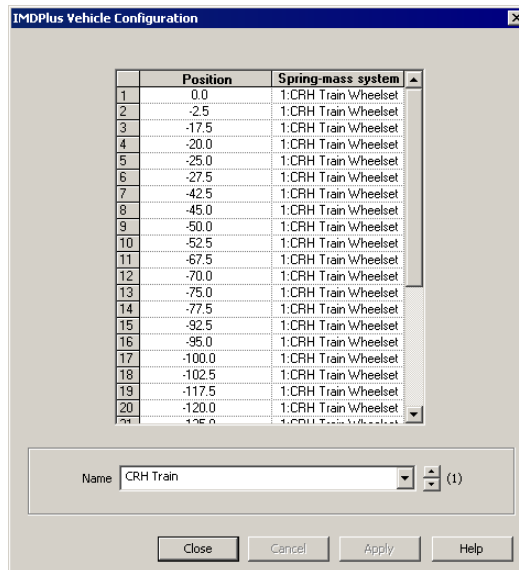

In an IMDPlus moving mass analysis a vehicle or trainset is represented by a number of spring-mass systems. A moving mass vehicle configuration includes the position (relative to the origin / front of the vehicle) of the axles/bogies that form the vehicle along with the spring-mass system attribute to be used at each position. Each row of the Spring-mass system column includes a drop-down list that contains all of the spring-mass system property attributes in the model. The spring-mass system properties required at each position can be selected for use in the vehicle configuration. A spring-

mass system property attribute can be used at multiple positions in a vehicle. An example of a moving mass vehicle configuration is shown in the figure. A meaningful name should be entered into the Name field.



**Note.** Care should be taken with the definition of the spring-mass system positions. The path length should be sufficiently longer than the structure to ensure that the vehicle configuration correctly arrives onto and departs from the structure.



**Note.** The front of the moving mass vehicle is always the position with the maximum co-ordinate. The rear of the vehicle is always the position with the minimum co-ordinate.



**Note.** The positions and spring-mass system identifiers that define the vehicle configuration can be copied and pasted from a Microsoft Excel spreadsheet. This method is demonstrated in the IMDPlus Worked Example: High Speed Train Modelling through Sprung Masses.



**Note.** Once created vehicle configurations will appear in the Utilities Treeview, from where they can be modified or deleted from the model. To modify a vehicle configuration either double-click or right-click on the Attribute name in the Utilities Treeview and select the **Edit Attribute...** menu item.



**Note.** Vehicle configurations can be easily transferred from one model to another using an attribute library file, accessed from the menu **File > Import/Export model data...**

### Moving Load Generation

In a moving mass analysis the moving load generator is used to mimic the path of a unit load across a structure by automatically setting up a number of static load cases at prescribed locations along a single line/arc/spline, or a collection of lines/arcs/splines, which define a single continuous path. These load cases are subsequently used to calculate the unit modal forces equivalent to the applied unit loading for import into IMDPlus, where the unit modal forces are used together with the vertical loading from each of the spring-mass systems to obtain the total modal force applied to the structure.



**Note.** In a moving mass analysis a discrete unit load must always be used in the moving load generator to ensure that the correct loads are applied to the structure during the IMDPlus analysis. The discrete unit load is used to calculate the unit modal forces that are applied to the structure as the discrete unit load moves along the moving load path. These unit modal forces are used in IMDPlus in conjunction with the vertical loading from the spring-mass systems of the vehicle configuration to calculate the total modal forces applied to the structure.

Before entering the moving load generator, the lines/arcs/splines defining the path must be selected and a discrete load representing the unit load configuration for the

axles/bogies of the vehicle that is to be moved across the structure must have been defined. Examples of discrete unit loads are shown in the following figures.

The 'Point' dialog box is shown with the following settings:

- Arbitrary** (selected)
- Grid**: x = 1, y = 1
- Untransformed load direction**: X, Y, Z (all unselected)
- Projection vector**:  Project in load direction
  - X component: 0.0
  - Y component: 1.0
  - Z component: 0.0

	X	Y	Z	Load
1	0	0	0	-1.0

Name: Unit Wheelset Load (new)



The 'Point' dialog box is shown with the following settings:

- Arbitrary** (selected)
- Grid**: x = 1, y = 1
- Untransformed load direction**: X, Y, Z (all unselected)
- Projection vector**:  Project in load direction
  - X component: 0.0
  - Y component: 0.0
  - Z component: 1.0

	X	Y	Z	Load
1	0	-1.5	0	-0.25
2	0	-0.5	0	-0.25
3	0	0.5	0	-0.25
4	0	1.5	0	-0.25

Name: Unit HB Axle (new)

### Generation of the Moving Load Discrete Locations

The IMDPlus moving load generation dialog is accessed from the **Analyses > IMDPlus > Moving Mass > Moving Load Generation...** menu or from the IMDPlus Toolbar. Ensure the  button is selected to choose a moving mass analysis and then select the  button to launch the moving load generation dialog.

If a valid continuous path has been selected and a valid discrete unit load defined then the moving load generator can be used to create the static load cases at prescribed locations along the path.

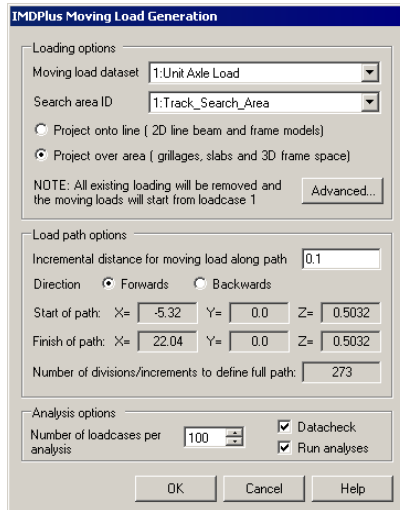

The screenshot shows the 'IMDPlus Moving Load Generation' dialog box. It is divided into three main sections: 'Loading options', 'Load path options', and 'Analysis options'.  
- **Loading options:** 'Moving load dataset' is set to '1:Unit Axle Load' and 'Search area ID' is '1:Track\_Search\_Area'. There are two radio buttons: 'Project onto line ( 2D line beam and frame models)' (unselected) and 'Project over area ( grillages, slabs and 3D frame space)' (selected). A note states: 'NOTE: All existing loading will be removed and the moving loads will start from loadcase 1'. An 'Advanced...' button is present.  
- **Load path options:** 'Incremental distance for moving load along path' is '0.1'. 'Direction' has 'Forwards' selected and 'Backwards' unselected. 'Start of path' has X=-5.32, Y=0.0, Z=0.5032. 'Finish of path' has X=22.04, Y=0.0, Z=0.5032. 'Number of divisions/increments to define full path' is '273'.  
- **Analysis options:** 'Number of loadcases per analysis' is '100'. 'Datacheck' and 'Run analyses' are both checked.  
Buttons for 'OK', 'Cancel', and 'Help' are at the bottom.

If a search area has been defined then this can be used to correctly assign the moving load if there are multiple planes to which the discrete unit load could be assigned. **Project onto line** or **Project over area** can be selected depending upon the geometry defining the search area. For single deck models, the default search area which encompasses the whole structure can be used. Parameters for the inclusion of the load can be accessed through the **Advanced...** button which provides the full application options available for discrete unit loads. These options consist of the inclusion of loads outside the search area and the load factor to be applied. The load factor for a moving mass analysis should always be set to 1.0.



**Note.** In a moving mass analysis the load factor defined under the **Advanced...** options should always be set to 1.0 as the moving load generator needs to define the passage of a discrete unit load across the structure. Any factor other than 1.0 can cause the incorrect static and dynamic loads to be calculated during a moving mass analysis.

Having defined the loading options, the load path options can be set based on the lines/arcs/splines selected to define the path. The incremental distance controls the separation of the discrete unit load locations used to define the passage of the unit load across the structure. This incremental distance should be positive and sufficiently small to capture the movement of the load.



**Note.** Due to the dynamic solution a sufficiently small distance should be used between the discrete locations defining the passage of the unit load to minimise oversampling for load locations between those defined.

Ideally, the distance increment used for the movement of the unit load along the path should obey the following equation:

$$\delta \text{Dist} \leq 10 \times \text{Minimum Speed} \times \delta t$$

to give a maximum oversample of 10.  $\delta t$  is the minimum of the Nyquist time step and any user specified time step ( $\delta t^{\text{Nyquist}} = 1/(2 * f_{\text{max}})$  where  $f_{\text{max}}$  is the maximum frequency included in the analysis). Larger distance increments can be used but warnings will be issued by IMDPlus since the accuracy of the dynamic solution decreases with increasing oversampling ratio. Oversampling ratio reduces with increasing speed and therefore it is possible that higher oversampling ratios can be used for lower speeds where the dynamic excitation is reduced. It is however up to the user to ensure that use of higher oversampling ratios for any speed does not adversely affect the solutions to the dynamic analysis.

The moving load path forwards direction is defined by the order of selection of the lines, arcs or splines. The path starts at the first line that is connected to only one other selected line. If only a single line is selected, the forwards direction of the moving load path is defined by the line direction defined in Modeller (Line directions can be visualised through the Geometry layer in the Treeview). The direction that the moving load travels can be toggled between forwards and backwards relative to the original line selection for the generation of the discrete locations. The start and end of the path will be displayed along with the number of divisions / increments required for the full description.

The number of load cases per analysis controls the number of load cases for each LUSAS analysis used to obtain the loading information. By default this is set to 100 but can be increased up to 1000. It is recommended that the option to perform a datacheck analysis instead of a full static solution is always selected as an IMDPlus moving mass analysis only requires the unit loading vector information from the datacheck analysis.



**Note.** In a moving mass analysis a full static solution will only take into account the loading from the discrete unit load and will not include the total static loading from the spring-mass systems of the vehicle configuration. The results of the static analysis will therefore not correspond to the total vehicle loading that is going to be applied to the structure.

An option is also available not to run the analyses immediately. By default the LUSAS analyses will be carried out once the OK button has been clicked. If however the user wishes to run a large number of analyses resulting from the moving load definition overnight, this option can be switched off and a batch file generated so the analyses can be run separately. The original model, associated eigenvalue results and static load cases must be loaded prior to proceeding to the next stage of the moving mass analysis. This can be carried out by running the following two VBScript files which will have been generated in the directory `\<LUSAS Installation Folder>\Projects\<Model Name>\Associated Model Data\<Model Name>`



### **IMDPlus\_Model\_Reload.vbs**

Reloads the model and eigenvalue results



### **IMDPlus\_LoadVector\_Load.vbs**

Loads the static results on top of the model and eigenvalue





**Note.** If for any reason the model and static load cases need to be loaded for the current moving load path and configuration in the future, these two VBScript files can be used.

## **Modal Force Calculator**

The path and configuration of the moving unit load should have been defined using the moving load generation described previously. The discrete unit loads at distances along the path now need to be converted into equivalent modal forces for import into IMDPlus. This is carried out using the modal force calculator.

The IMDPlus modal force calculator dialog is accessed from the **Analyses > IMDPlus > Moving Mass > Modal Force Calculator...** menu or from the IMDPlus Toolbar.

Ensure the  button is selected to choose a moving mass analysis and then select the  button to launch the modal force calculator dialog.

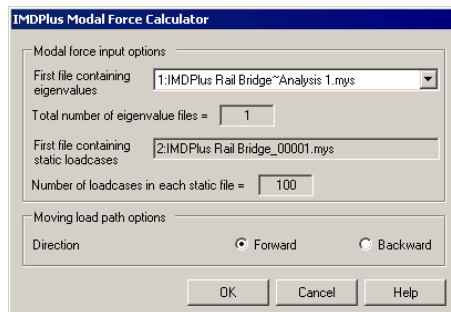

On entry, the eigenvalue and static results will be identified and placed into the dialog. Multiple eigenvalue results files are supported which allows the solution of structures with large numbers of eigenvalues over multiple analyses with frequency / eigenvalue ranges.

The moving load path options allow the user to change the direction of the unit load movement along the path but this option should not be used unless the load configuration is symmetrical.



**Note.** Once the moving load generation and modal force calculation have been carried out in a moving mass analysis, these two steps may be omitted from subsequent





analyses, even if the analysis type is switched from moving mass to moving load but only if the moving load path, discrete load configuration and direction of the moving load do not change between analyses. If any of these are modified the moving load path and calculation of equivalent modal forces must be carried out again.

### Running the Moving Mass Analysis

An IMDPlus moving mass analysis can only be performed if the following steps have already been undertaken:

- The equivalent modal forces have been successfully calculated using the moving load generator and the modal force calculator. A discrete load representing the unit load configuration for the axles/bogies of the vehicle that is to be moved across the structure must be used in the calculation of the modal forces to ensure that the correct loads are applied to the structure during the moving mass analysis.
- At least one moving mass vehicle configuration has been defined in the model

The IMDPlus moving mass analysis control dialog is accessed from the **Analyses > IMDPlus > Moving Mass > Moving Mass Analysis...** menu or from the IMDPlus Toolbar. Ensure the  button is selected to choose a moving mass analysis and then select the  button to launch the moving mass analysis control dialog.

On entering moving mass analysis control for the first time the dialog will be filled with default information, as shown by the example in the following figure.

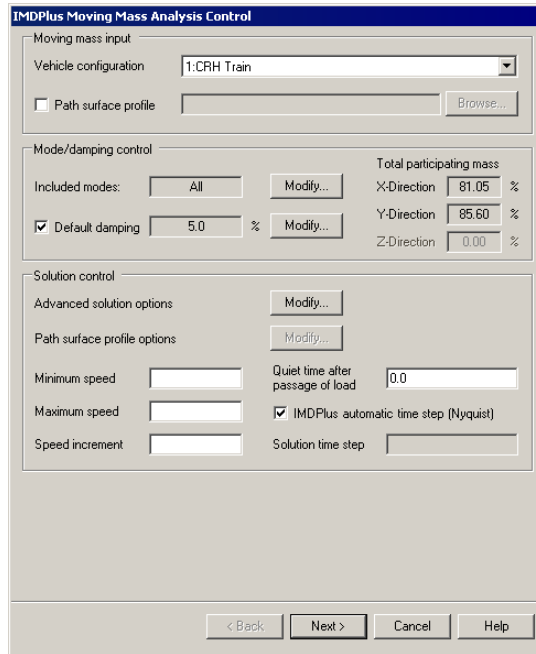

## Moving Mass Input

### Vehicle Configuration

The vehicle configuration drop-down list will contain all of the moving mass vehicle configurations in the model. The required vehicle configuration can be selected for use in the IMDPlus analysis.

### Path Surface Profile

The surface roughness of the structure along the path followed by the moving mass vehicle can be optionally included via a perturbation of the vertical displacement of the structure. This is termed the path surface profile displacement and it is added to the displacements of the unsprung masses during the analysis. The path surface profile velocity and acceleration vertical components are calculated during the IMDPlus analysis and also applied to the unsprung masses for dynamic consistency.

The path surface profile displacements are defined in a path surface profile file. Select the checkbox marked Path surface profile to include a path surface profile file in the IMDPlus moving mass analysis. This will enable the **Browse...** button so that the file can be selected, as shown by the example in the following figure.

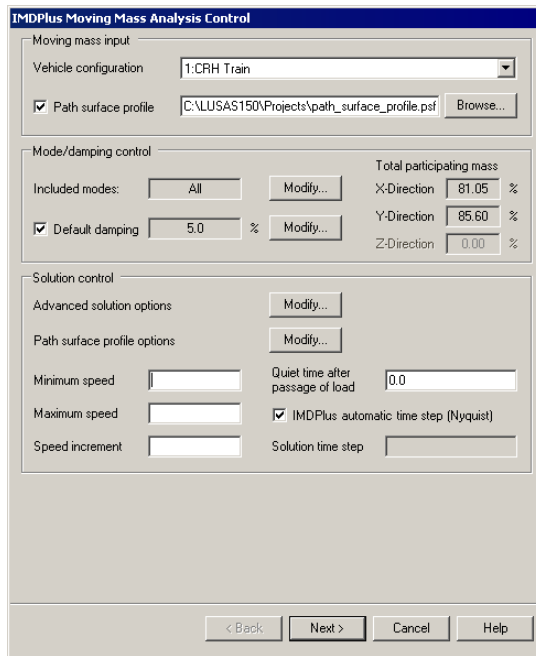

The path surface profile file can contain either space, Comma Separated Variable (CSV) or TAB delimited data and must include a piecewise linear displacement vs. distance relationship that defines the surface irregularities along the path traversed by the moving mass vehicle. An example of a path surface profile is shown in the following figure. There should be a total of NPSP lines of data (NPSP defined below) in the file. All input data must be valid integer or real numbers and each line of the file should contain two data records as follows:

```

For i=1,NPSP
Disti    PSPi
End loop over NPSP
    
```

The path surface profile data is defined as follows:

- **NPSP**
  - The number of data points in the path surface profile
  - There must be a minimum of 2 data points in order to define a valid profile
- **Dist<sub>i</sub>**

The distance relative to the origin of the moving load path

  - Distances should be defined in the model length units
  - The distance of the first data point must be 0.0

- The distances must be defined so that they are monotonically increasing
- Care should be taken to ensure that the last distance point in the file is equal to or greater than the length of the path. If this is not the case an additional point is automatically introduced during the IMDPlus analysis with a distance equal to the path length and a displacement of 0.0

### □ $PSP_i$

The surface irregularity vertical displacement at the distance  $Dist_i$

- Displacements should be defined in the model length units
- The displacement of the first data point must be 0.0

An example of a path surface profile file is shown in the following figure.

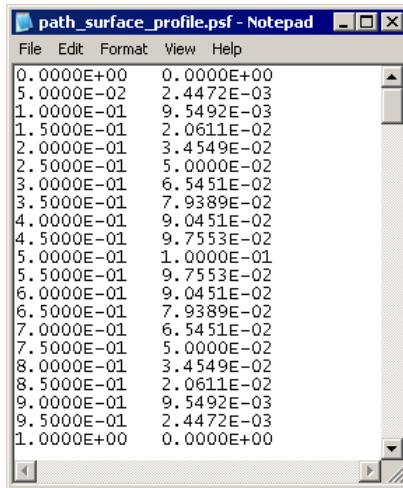

## Mode / Damping Control

The modes to include in the analysis can be controlled either by the eigenmodes solved in the eigenvalue analysis or a subset defined in the mode control. The default option when first running an analysis is for all modes to be included in the analysis but individual modes can be included or excluded using the following dialog accessed via the **Modify...** button on the moving mass analysis dialog.

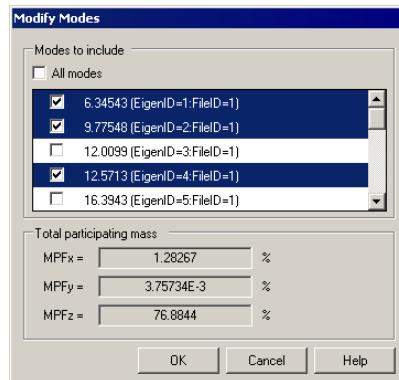

This dialog also calculates the total participating mass for the included modes. If a significant proportion of participating mass is missing based on the selected modes of vibration a warning will be issued when proceeding with the analysis. Omission of modes of vibration with significant mass contributions that can be excited during the analysis will lead to unreliable solutions. Ideally, total mass participations in excess of 90% should be used unless it is guaranteed that the modes of vibration associated with any missing mass are at frequencies that cannot be excited.

The Default damping option allows the user to control the amount of damping used in the IMDPlus analysis. If Default damping is selected, all of the modes of vibration included in the analysis are forced to have the current default value. The default value is set, via the **Modify...** button on the moving mass analysis control dialog.

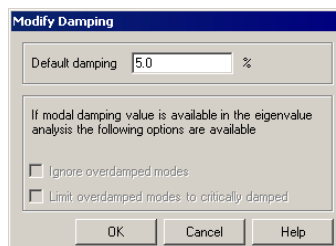

The Default damping option can only be turned off when viscous damping has been included in the eigenvalue analysis. If Default damping is deselected the viscous damping present in the eigenvalue analysis is used in the IMDPlus analysis. When viscous damping is included in the eigenvalue solution additional options for the inclusion of overdamped modes of vibration in the IMDPlus analysis also become available. These options are as follows:

**Ignore overdamped modes**

Modes of vibration with a damping ratio of 100% or more are omitted from the IMDPlus solution.

### Limit overdamped modes to critically damped

Modes of vibration with a damping ratio of 100% or more are limited to 99.9999% to allow them to be included in the analysis.

## Solution Control

The speeds and time stepping information are input via the solution control section. The input includes a range of speeds for the solution defined using a minimum speed, maximum speed and a speed increment. If only a minimum or maximum speed is specified then one speed, equal to the value entered, will be analysed for the vehicle configuration selected. A quiet time can be specified which allows for the inclusion of a user defined length of time after the passage of the vehicle along the path. This enables decay of the structural vibration to be analysed. By default, IMDPlus determines the time step required for the analysis from the Nyquist time step. This is calculated from the maximum frequency included in the analysis. User control over the time step for the solution is available by disabling this feature.

### Advanced Moving Mass Solution Options

Advanced solution options can be set via the **Modify...** button on the moving mass analysis control dialog.

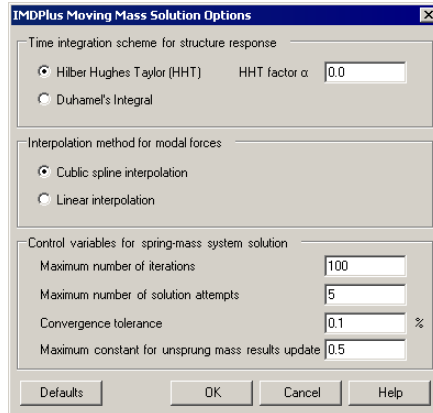

The options available in a moving mass analysis are as follows. The **Defaults** button resets all of the options to the default values.

### Time integration scheme for structure response

The implicit time integration scheme used by IMDPlus to calculate the dynamic response of the structure.

#### Hilber Hughes Taylor (HHT)

This is the default time integration scheme and is the same as the method used for an implicit transient dynamic analysis in LUSAS.

**□ HHT factor  $\alpha$**

The integration constant  $\alpha$  used in the HHT integration scheme. For an unconditionally stable, second order accurate scheme,  $\alpha$  must lie between the limits  $-1/3 \leq \alpha \leq 0.0$ . Values of  $\alpha$  outside this range cannot be specified. The default value of  $\alpha$  is 0.0, which reduces the method to the Newmark method. Further integration constants  $\beta$  and  $\gamma$  are computed automatically by IMDPlus using the following equations:

$$\beta = (1 - \alpha)^2 / 4 \quad , \quad \gamma = (1 - 2\alpha) / 2$$

**□ Duhamel's Integral**

This is the time integration method used by IMDPlus in LUSAS 14.7 (and earlier versions of LUSAS) and is available as an alternative to the HHT integration scheme.



**Note.** When Duhamel's Integral is selected the HHT factor  $\alpha$  remains active and can still be modified. In moving mass analysis the HHT scheme is always used to calculate the dynamic response of the spring-mass systems, irrespective of the time integration scheme selected. The value of  $\alpha$  will therefore always have an effect on a moving mass analysis.

**□ Interpolation method for modal forces**

The interpolation method used by IMDPlus to calculate the equivalent modal forces from the values obtained at the discrete path locations by the modal force calculator.

**□ Cubic spline interpolation**

Equivalent modal forces are interpolated using a cubic spline interpolation technique. This is the default option.

**□ Linear interpolation**

Equivalent modal forces are interpolated using a linear interpolation technique.

**□ Control variables for spring-mass system solution**

The variables used to control the solution of the spring-mass systems as they move across the structure.

**□ Maximum number of iterations**

The maximum number of iterations allowed for the spring-mass system and structural solution. The default is 100 iterations per solution attempt. If convergence problems occur this value may need to be increased.

### **Maximum number of solution attempts**

The maximum number of solution attempts allowed during the spring-mass system and structural solution for each time step of the analysis. The default is 5. If convergence problems occur this value may need to be increased.

### **Convergence tolerance**

The convergence tolerance used for the spring-mass system and structural solution. The default is 0.1%. Increasing the convergence tolerance can reduce the time taken to perform an analysis but may produce inaccurate results.

### **Maximum constant for unsprung mass results update**

The maximum constant,  $C_{USM}$ , used in the calculation of the unsprung mass results. The default is 0.5 and the constant must lie between the limits  $0.0 < C_{USM} \leq 1.0$ . Larger values of  $C_{USM}$  can be used to reduce the time taken to perform an analysis but may result in convergence problems. If convergence problems do occur this value may need to be reduced.

## **Path Surface Profile Options**

If a path surface profile has been included in the analysis advanced path surface profile options can be set via the **Modify...** button on the moving mass analysis control dialog.

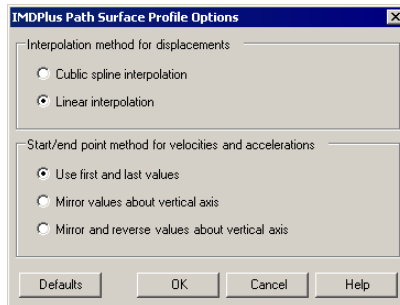

The path surface profile options are as follows. The **Defaults** button resets all of the options to the default values.

### **Interpolation method for displacements**

The interpolation method used by IMDPlus to calculate the path surface profile displacements from the discrete values defined in the path surface profile file.

#### **Cubic spline interpolation**

Path surface profile displacements are interpolated using a cubic spline interpolation technique.



**Linear interpolation**

Path surface profile displacements are interpolated using a linear interpolation technique. This is the default option.

**Start/end point method for velocities and accelerations**

IMDPlus calculates path surface profile velocities and accelerations from the displacement data defined in the path surface profile file. In order to calculate the complete velocity and acceleration profiles, displacement values beyond the extent of the user defined data are required. This option defines the method that is used to extrapolate the displacement profile at the start and end times of the analysis.

**Use first and last values**

Displacement data is extrapolated using the path surface profile displacement values at the start and end of the analysis. This assumes that the displacement profile continues indefinitely with the first and last values. This is the default option and will be applicable in the majority of analyses.

**Mirror values about vertical axis**

Displacement data is extrapolated by mirroring it about the vertical axis at the start and end of the analysis. For example, this option would be applicable where the path surface profile is defined using a cosine function which has peak values at the start and end of the analysis.

**Mirror and reverse values about vertical axis**

Displacement data is extrapolated by mirroring it about the vertical axis at the start and end of the analysis and then multiplying the extrapolated data by -1. For example, this option would be valid where the path surface profile is defined using a sine function with zero displacement at the start and end of the analysis.

## Visualising the Results

Results are extracted from IMDPlus through the output control dialog which is used for all of the seismic, moving load and moving mass analysis options. The IMDPlus output control dialog is accessed by selecting **Next>** from the seismic, moving load or moving mass analysis control dialogs or by selecting the  button from the IMDPlus Toolbar.



**Note.** The  button will only be available for selection when an IMDPlus analysis has been performed and the results are still available on disk for graphing.

For a seismic analysis the nodes or elements that are to be analysed are defined, together with the type of output that will be generated by IMDPlus. In addition, the

**Earthquake to graph** is selected using the drop-down list next to the **Generate graphs in Modeller** option. Examples of the appearance of the seismic output control dialog when processing an individual node or a selection of nodes are illustrated in the following figure.

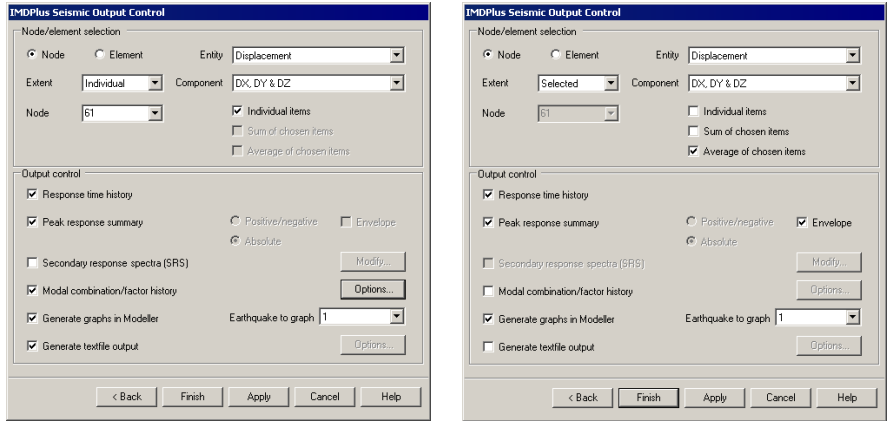

Individual Node

Selected Nodes

### Seismic Analysis – Output Control Dialog

For a moving load analysis the nodes or elements that are to be analysed are defined, together with the type of output that will be generated by IMDPlus. In addition, the moving load **Speed to graph** is selected via the list next to the **Generate graphs in Modeller** option. Examples of the appearance of the moving load output control dialog when processing an individual element or a selection of elements are illustrated in the following figure.

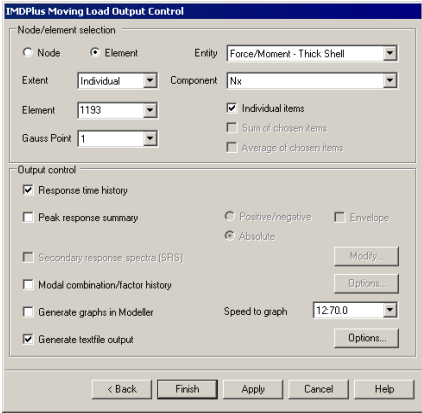

Individual Element

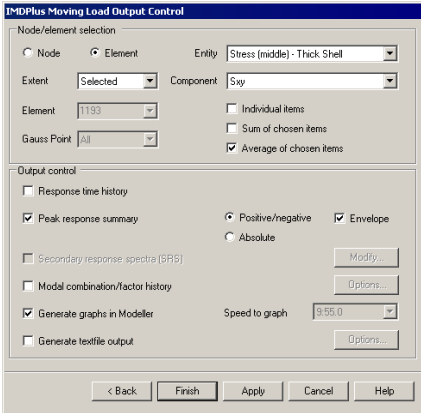

Selected Elements

Moving Load Analysis – Output Control Dialog

For a moving mass analysis the nodes, elements or spring-mass systems that are to be analysed are defined, together with the type of output that will be generated by IMDPlus. In addition, the moving mass **Speed to graph** is selected via the list next to the **Generate graphs in Modeller** option. Examples of the appearance of the moving mass output control dialog when processing an individual node or an individual spring-mass system are illustrated in the following figure.

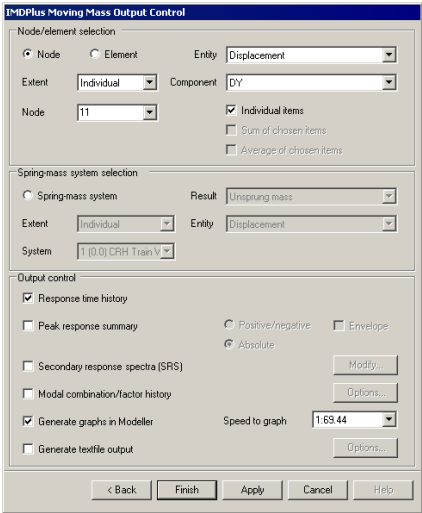

Individual Node

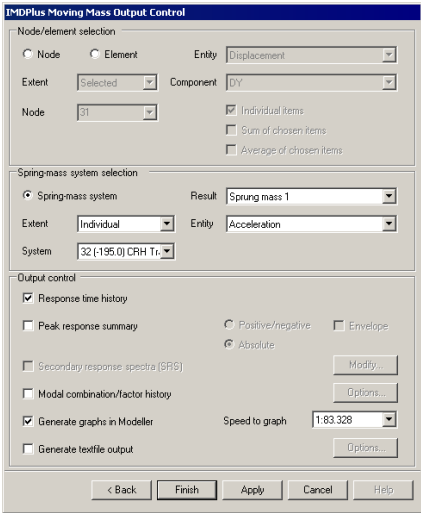

Individual Spring-Mass System

Moving Mass Analysis – Output Control Dialog

### Node / Element Selection

In this section of the output control dialog the nodes or elements that are to be analysed are defined, together with the result entity and component and the type of output that will be generated by IMDPlus.

#### Processing Individual, Selected or All Nodes or Elements

The **Extent** drop-down list includes the following options to determine whether individual or multiple, nodes or elements will be processed by IMDPlus. This enables results for a chosen set of nodes or elements to be obtained in a single IMDPlus analysis.

**Individual**

Process a single node or element in IMDPlus. This option is always available for both **Node** and **Element**. With **Individual** the **Node** or **Element** lists are enabled and filled with the node numbers or valid IMDPlus element numbers selected in the model. Any of the node or element numbers listed can be chosen for the analysis or alternatively a valid node or element number can be manually specified by the user.

**Selected**

Process the nodes or valid IMDPlus elements selected in the model. For **Node** this option will be available if nodes have been selected in the model. For **Element** the option will be available if valid IMDPlus elements have been selected in the model and they are all the same type.

**All**

Process all of the nodes or valid IMDPlus elements in the model. For **Node** this option is always available. For **Element** the option will only be available if all of the elements in the model are the same type.



**Note.** When analysing multiple elements, using **Selected** or **All**, only elements of the same type, that is, bar, thick beam, continuum, thick shell or thin shell elements, can be included in a set of IMDPlus elements. The element set can, however, contain elements with different numbers of Gauss points or nodes.



**Note.** When **Extent** is set to **Selected** or **All** the Node, Element and Gauss Point/Node/End drop-down lists will not be available for selection. In addition the element Gauss Point/Node/End is automatically set to **All** as multiple elements are going to be processed in a single analysis.



**Note.** Both **Generate graphs in Modeller** and **Generate textfile output** can be used when processing multiple node or element objects. With **Generate textfile output** a number of output file formats are supported by IMDPlus to allow import of results into graphing packages. These are discussed in the Output Control section presented later.

## Entity and Component Output

If **Node** output is selected, result entities supported are displacements, velocities, accelerations, and reactions plus, for moving load and moving mass analyses, dynamic amplification factors. The available components placed into the list will depend on the nodes chosen for the analysis. In addition to the standard single component output, options are also available to output all translational or rotational displacements, velocities, accelerations, reactions and dynamic amplification factors (when applicable) to the same graph.

If **Element** output is selected, the result entities supported are governed by the element type chosen. For example, choosing a thick shell element allows selection of the Stress resultants (such as  $N_x$ ,  $M_x$  and  $S_x$ ), Stress (Top/Middle/Bottom) and Strain (Top/Middle/Bottom). Depending upon the element type either Gauss point, node or end results are available with the ability to select either a single location or All locations for an individual element. For a complete list of the output supported refer to the list of elements supported by IMDPlus.

## Results for Individual items, Sum of chosen items and Average of chosen items

The **Individual items**, **Sum of chosen items** and **Average of chosen items** options determine the type of node or element output that will be generated by IMDPlus, see also **Response time history** and **Peak response summary** in the following section.

### Individual items

This option produces individual results for each of the chosen nodes or element Gauss points/nodes/ends.

### Sum of chosen items

This option adds together results from the chosen nodes or element Gauss points/nodes/ends to give summed node or element time histories from which peaks of the summed results are obtained.

### Average of chosen items

This option obtains results by first summing the time history results from the chosen nodes or element Gauss points/nodes/ends. A simple average of this summed result is obtained to give the node or element average time histories from which the peak average results are obtained.

**Sum of chosen items** and **Average of chosen items** are only available for selection when **Extent** is set to **Selected** or **All**.



**Note.** Any combination of the options **Individual items**, **Sum of chosen items** and **Average of chosen items** can be used in an IMDPlus analysis, although using the **Individual items** option when **Extent** is set to **Selected** or **All** (nodes or elements) may

produce a very large number of graphs, depending on the number of nodes or elements chosen for processing.



**Note.** When processing reactions for a chosen set of nodes, **Sum of chosen items** and **Average of chosen items** only take into consideration nodes with supported freedoms.



**Note.** When processing dynamic amplification factors only averaged results can be obtained for a chosen set of nodes as summed results are meaningless for this result entity.

### Spring-Mass System Selection (Moving Mass Only)

This section of the output control dialog is only available in a moving mass analysis. It defines the spring-mass system, result and entity that will be processed by IMDPlus.



**Note.** Only one of the Node, Element or Spring-mass system radio buttons can be selected at any given time.

### Processing Individual or All Spring-Mass Systems

The **Extent** drop-down list includes the following options to determine which spring-mass systems will be processed by IMDPlus.

**Individual**

Process a single spring-mass system in IMDPlus. With Individual the System list is enabled and will contain, in sequential order, all of the system identifiers, together with the initial positions for each system and the spring-mass system property set used at each position, for the vehicle configuration selected in the IMDPlus moving mass analysis control dialog. Any of the spring-mass systems listed can be chosen for the analysis.

**All**

Process all of the spring-mass systems for the vehicle configuration selected in the IMDPlus moving mass analysis control dialog.



**Note.** When **Extent** is set to **All** the System drop-down list will not be available for selection.



**Note.** Both **Generate graphs in Modeller** and **Generate textfile output** can be used when processing all of the spring-mass systems. With **Generate textfile output** a number of output file formats are supported by IMDPlus to allow import of results into graphing packages. These are discussed in the Output Control section presented later.

### Result and Entity Output

The **Result** drop-down list contains the valid result types available for the system(s), selected using **Extent** and **System**. The result types available for selection depend on

number of sprung masses in the system, that is, unsprung mass only, single sprung mass or double sprung mass and whether a path surface profile has been included in the analysis. Results are generated as the spring-mass system moves across the structure and are available for the range of speeds defined in the IMDPlus moving mass analysis control dialog.

**Unsprung mass**

The results for the unsprung mass of the spring-mass system(s).

**Sprung mass 1**

The results for the 1<sup>st</sup> sprung mass of the spring-mass system(s).

**Sprung mass 2**

The results for the 2<sup>nd</sup> sprung mass of the spring-mass system(s).

**Contact point**

The structural results at the contact point(s) between the spring-mass system(s) and the structure.

**Path surface profile**

The path surface profile followed by the system(s). These can be used to confirm that the user defined path surface profile has been interpreted correctly by IMDPlus.

The **Entity** drop-down list contains the valid entities for the **Result** type selected. The entities available for selection are as follows;

**Displacement**

The vertical component of displacement for the **Result** type of the spring-mass system(s).

**Velocity**

The vertical component of velocity for the **Result** type of the spring-mass system(s).

**Acceleration**

The vertical component of acceleration for the **Result** type of the spring-mass system(s).

**Position**

The horizontal position of the unsprung mass of spring-mass system(s), relative to the initial position of the origin / front of the vehicle. This entity type is only available when **Result** is set to **Unsprung mass**

**Force**

The vertical force applied to the structure by the spring-mass system. This entity type is only available when **Result** is set to **Contact point**

### Output Control

The output control section selects the types of results to visualise. Options are:

**Response time history**

Response time history outputs node or element time history results for the selected **Entity** and **Component** or spring-mass system time history results for the selected **Result** and **Entity**.

Results available include displacements, velocities, accelerations, dynamic amplification factors and reactions for nodes, forces/moments, stresses/stress resultants and strains/strain resultants for elements and vertical displacement, velocity, acceleration, position and force for spring-mass systems.

For nodes or elements the type(s) of output generated depends on the options selected in the node / element selection section of the dialog as follows.

**Individual items**

Individual time history results for all of the chosen nodes or elements are generated.

**Sum of chosen items**

Summed time history results for the chosen set of nodes or elements are generated.

**Average of chosen items**

Averaged time history results for the chosen set of nodes or elements are generated.

When processing spring-mass systems individual time history results for the chosen system(s) are always generated.

**Peak response summary**

Peak response summary outputs maximum, minimum and/or absolute peak results and times for the selected node / element **Entity** and **Component** or the selected spring-mass system **Result** and **Entity**.

Results available include displacements, velocities, accelerations, dynamic amplification factors and reactions for nodes, forces/moments, stresses/stress resultants and strains/strain resultants for elements and vertical displacement, velocity, acceleration and force for spring-mass systems

When processing nodes or elements an **Envelope** of the peak results can also be obtained for all components of the current result **Entity**. These highlight the



individual nodes or element Gauss points/nodes/ends in the chosen set of nodes or elements where peak results occur for each of the earthquakes or speeds analysed.

For nodes or elements the type(s) of output generated depends on the options selected in the node / element selection section of the dialog as follows.

**Individual output**

Individual peak results for all of the chosen nodes or elements are generated.

**Sum of chosen items**

Peaks of the summed results for the chosen set of nodes or elements are generated. If **Envelope** has been selected an envelope of the individual peak results is also displayed in a Notepad application.

**Average of chosen items**

Peaks of the averaged results for the chosen set of nodes or elements are generated. If **Envelope** has been selected an envelope of the individual peak results is also displayed in a Notepad application.

When processing spring-mass systems individual peak summary results for the chosen system(s) are always generated.



**Note.** The options **Positive/Negative** and **Absolute** are not available for selection in a seismic analysis.



**Note.** Peak summaries are not available for spring-mass systems when **Result** is set to **Path surface profile** or **Entity** is set to **Position**



**Note.** The option **Envelope** is only available for selection when either **Sum of chosen items** or **Average of chosen items** is selected. **Envelope** is not available when spring-mass systems are being processed.

**Secondary response spectra (SRS)**

Secondary response spectra (SRS) outputs secondary response spectra based on the acceleration response for nodes. SRS output is not available for displacements, velocities, dynamic amplification factors or reactions at nodes and is not a valid option for elements or spring-mass systems. SRS output can only be used when both **Node** and **Individual items** are selected.

**Modal combination/factor history**

Modal combination/factor history outputs modal factors for the response of the structure at each time step of the analysis. The output takes the form of a VBScript file which can be imported into Modeller to define Modal Combinations of the modes of vibration.

**Generate graphs in Modeller**





**Note.** Peak response summary graphs can only be generated in a moving load or moving mass analysis. For a seismic analysis the results are presented in tabular format.

```

#
#
# | Record = 001 |
#
# Entity          Time          Value
Peak_Pos_AX      4.815000000    14.47622283
Peak_Neg_AX      2.355000000   -14.77033402
Abs_Peak_AX      4.815000000    14.47622283
Peak_Pos_AV      1.025000000    6.383298190
Peak_Neg_AV      3.410000000   -5.046098466
Abs_Peak_AV      1.025000000    6.383298190
Peak_Pos_RAZ     1.050000000    2.071596885
Peak_Neg_RAZ     1.030000000   -2.024639500
Abs_Peak_RAZ     1.030000000    2.071596885
Abs_Peak_RSLT    4.815000000    14.62696551
#
#
# | Record = 002 |
#
# Entity          Time          Value
Peak_Pos_AX      9.360000000    8.342386674
Peak_Neg_AX      9.595000000   -7.757532327
Abs_Peak_AX      9.360000000    8.342386674
Peak_Pos_AV      9.435000000    1.720681106
Peak_Neg_AV      9.350000000   -1.439667728
Abs_Peak_AV      9.435000000    1.720681106
Peak_Pos_RAZ     9.610000000    0.453032819
Peak_Neg_RAZ     9.370000000   -0.586691605
Abs_Peak_RAZ     9.370000000    0.586691605
Abs_Peak_RSLT    9.355000000    8.415540215
    
```

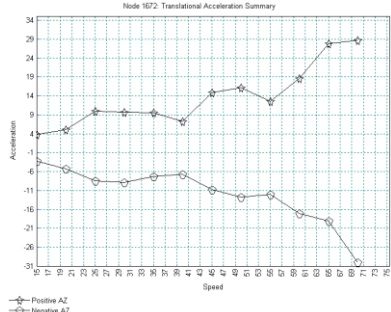

Peak Response Text Output For Seismic Analysis

Peak Response Plot For Moving Load Analysis

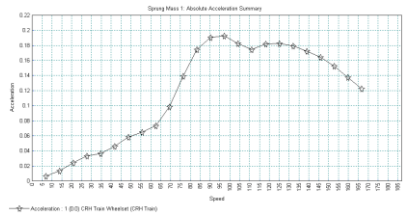
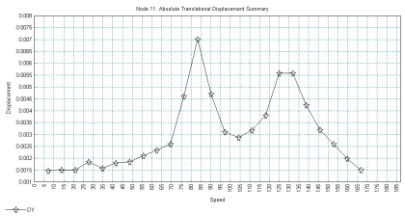

Peak Response Plots For Moving Mass Analysis

**Secondary Response Spectra (SRS)**

Secondary Response Spectra (SRS) are computed for the selected nodes from the time history acceleration responses. The damping ratio range for the SRS calculations along with the frequency resolution are accessed via the **Modify...** button. In this dialog the minimum and maximum damping ratios can be entered along with the damping ratio increment. Control is also provided over the resolution of the SRS results computed.

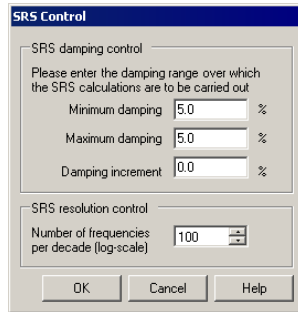

Examples of SRS plots are shown in the following figures:

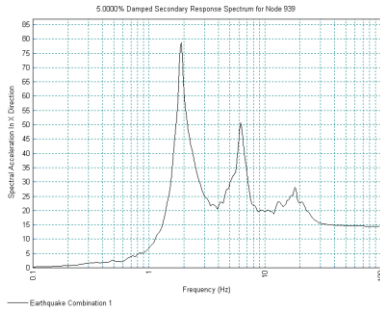

SRS Plot For Seismic Analysis

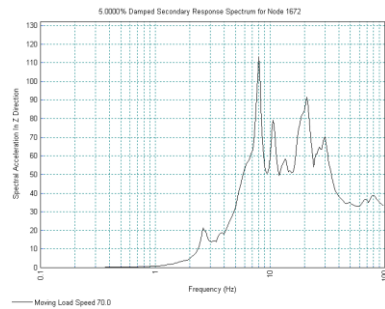

SRS Plot For Moving Load Analysis

### Modal Combination/Factor History

Modal combination/factor history outputs modal factors for the response of the structure at each time step of the IMDPlus analysis. The modal combination history options are accessed via the **Options...** button. In this dialog the minimum mass participation factor percentage to include in the exported modal combinations can be defined.

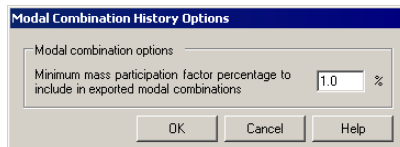

The output takes the form of a VBScript file which can be imported into Modeller to define modal combinations. These combinations can then be used to visualise the deformations and produce contour plots of entities other than velocities and accelerations, such as the examples shown in the following figures.



**Note.** Importing all modal combinations could take significant time. For inspecting key times during the analysis the required combination information can be extracted from the original VBScript file and placed into a user defined VBScript file.

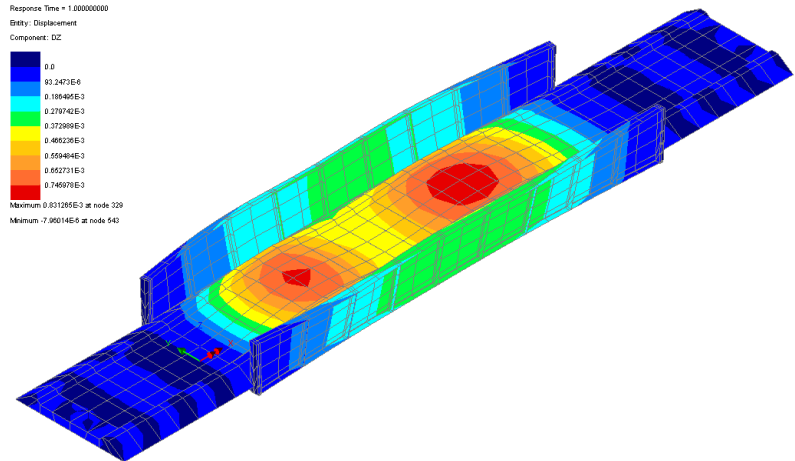

Vertical displacement plot for a time of 1.0s

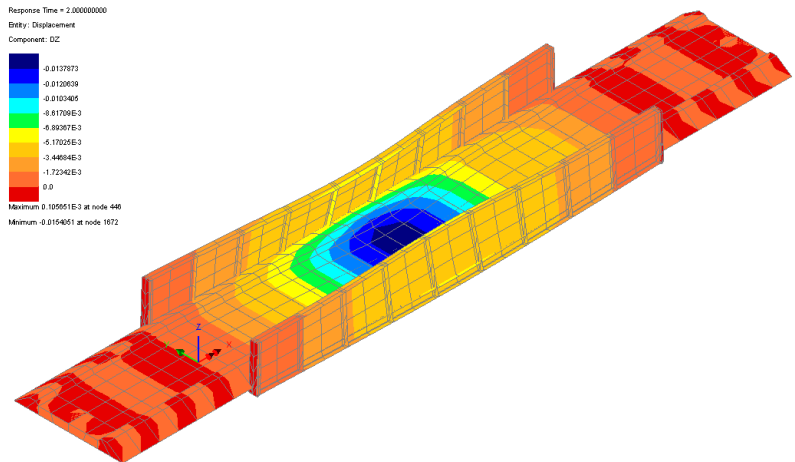

Vertical displacement plot for a time of 2.0s

**Generate Textfile Output**

If the option **Generate textfile output** is selected the results from the IMDPlus analysis will remain in the `\<LUSAS Installation Folder>\Projects\<Model Name>\Associated Model Data\<Model Name>` directory after completion of the

analysis. This allows the IMDPlus results to be archived and exported to additional graphing packages. If graphs are being generated in Modeller, the output format for these text files is the default IMDPlus format, which has all of the QA information placed in the header of the file and the results written in space delimited format. If however the option to **Generate graphs in Modeller** is switched off additional output formats become available via the **Options...** button which opens the following dialog.

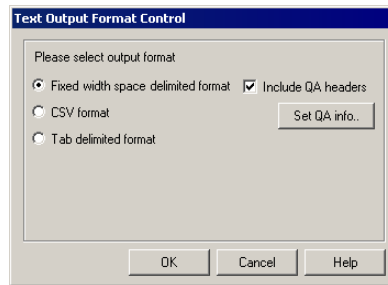

The formats supported are:

- Fixed width space delimited format** (IMDPlus default). Additional options are available to exclude the QA headers and set the QA information.
- Comma Separated Variable (CSV) format.**
- TAB delimited format.**

For all text output formats, the extensions of the files indicate the results entity. The following list describes the output file extensions used by IMDPlus:

- \*.**dsp** - Displacements/Rotations
- \*.**vel** - Velocities/Rotational Velocities
- \*.**acc** - Accelerations/Rotational Accelerations
- \*.**daf** - Dynamic Amplification Factors
- \*.**rcf** - Force/Moment Reactions
- \*.**srs** - Secondary Response Spectra
- \*.**fce** - Forces/Forces and Moments
- \*.**str** - Stresses/Stress Resultants
- \*.**stn** - Strains/Strain Resultants
- \*.**pos** - Positions of Spring-Mass Systems
- \*.**cfv** - Vertical Forces for Spring-Mass Systems

\*.sum - Peak response summary

## Elements Supported By IMDPlus

Results for the following elements can be output and graphed directly from IMDPlus. Elements that are excluded from this list and are valid for 2D/3D eigenvalue analyses can still be used in an IMDPlus analysis but the results for these unsupported elements must be obtained through the modal combinations facility available in IMDPlus. All element output follows the default LUSAS Solver output directions (local or global) for the element types below. For further information please refer to the LUSAS Element Reference Manual.

- Bar Elements** (Gauss Point Results)
  - BAR2 - 2D 2-noded Bar
  - BRS2 - 3D 2-noded Bar
- Beam Elements** (End Results)
  - BEAM - 2D Engineering Thick Beam
  - BMS3 - 3D Engineering Thick Beam
  - BTS3 - 3D Thick Beam
  - BMI21 - 3D Thick Beam
  - BMI22 - 3D Thick Beam
  - BMI31 - 3D Thick Beam
  - BMI33 - 3D Thick Beam
- 2D Continuum Elements** (Gauss Point Results)
  - TPM3, TPM6, QPM4, QPM8 - 2D Plane Stress
  - QPM4M - 2D Plane Stress (Enhanced Strain)
  - TPK6, QPK8 - 2D Plane Stress Crack Tip
  - TPN3, TPN6, QPN4, QPN8 - 2D Plane Strain
  - QPN4M - 2D Plane Strain (Enhanced Strain)
  - TNK6, QNK8 - 2D Plane Strain Crack Tip
- 3D Continuum Elements** (Gauss Point Results)
  - TH4, TH10, PN6, PN12, PN15,
  - HX8, HX16, HX20 - 3D Solid
  - HX8M - 3D Solid (Enhanced Strain)
- Thin Shell Elements** (Nodal Results)
  - TS3, QSI4 - 3D Flat Thin Shell
  - SHI4 - 3D Flat Thin Box Shell
- Thick Shell Elements** (Gauss Point Results)

TTS3, TTS6, QTS4, QTS8 - 3D Thick Shell

❑ **Joint Elements** (Gauss Point Results)

JNT3 - 2D Joint Element for Bars, Plane Stress and Plane Strain

JPH3 - 2D Joint Element for Engineering Beams

JNT4 - 3D Joint Element for Bars and Solids

JSH4 - 3D Joint Element for Engineering Beams and Shells

## Worked examples

IMDPlus worked examples are supplied as part of a software installation and can also be accessed via the LUSAS Modeller online help system. They can also be downloaded from the LUSAS website.







**LUSAS**

LUSAS, Forge House, 66 High Street, Kingston upon Thames, Surrey, KT1 1HN, UK  
Tel: +44 (0)20 8541 1999 | Fax: +44 (0)20 8549 9399 | [info@lusas.com](mailto:info@lusas.com) | [www.lusas.com](http://www.lusas.com)