

Linear Analysis of a Composite Strip

For LUSAS version:	19.0
For software product(s):	LUSAS Composite Plus
With product option(s):	None

Description

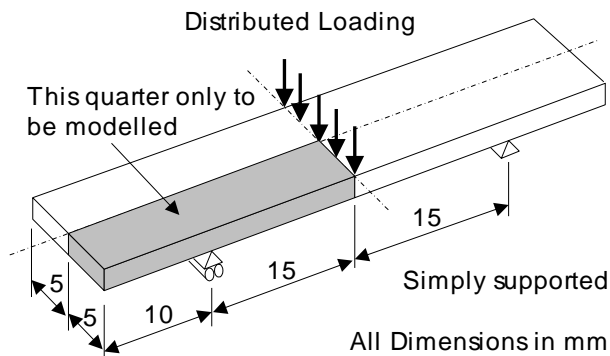

A 50mm x 10mm x 1mm thick composite strip, composed of an 8-layer composite material is to be analysed first using shell elements and then using solid elements in order to compare the results obtained.

The strip is loaded with a global distributed line load of 10N/mm on the centreline as shown. The composite strip has two axes of symmetry therefore only a quarter of the strip needs to be modelled. Symmetry boundary conditions are to be simulated by applying supports on the appropriate Lines. The geometry of the strip and support positions are as shown.

Units used are N, mm, t, s, C throughout.

Objectives

Surface features meshed with thick shell composite elements. The output from the shell analysis will consist of:

- Deformed Mesh Plot showing displacements with peak values annotated.
- Bending Stress Contour Plot showing the direct stresses on the bottom Surface.

Volume features meshed with solid composite elements. The output from the solid analysis will consist of:

- Deformed Mesh Plot showing displacements with peak values annotated.
- Bending Stress Contour Plot showing the direct stress on the bottom Surface of layer 1.
- Shear Stress Contour Plot showing the interlamina shear stress on the top Surface of layer 1.

Keywords

2D, 3D, Composite, Shell, Solid, Lay-up. Interlamina Shear, Failure Criteria, Tsai-Wu

Associated Files



- strip_shell_modelling.vbs** carries out the modelling of the example using shell elements.
- strip_solid_modelling.vbs** carries out the modelling of the example using solid elements.

Modelling : Shell Model

Running LUSAS Modeller

For details of how to run LUSAS Modeller, see the heading *Running LUSAS Modeller* in the *Introduction to LUSAS Worked Examples* document.



Note. This example is written assuming a new LUSAS Modeller session has been started. If continuing from an existing Modeller session select the menu command **File>New** to start a new model file. Modeller will prompt for any unsaved data and display the New Model dialog.

Creating a new model

- Enter a file name of **strip_shell**

- Use the default User-defined working folder.
- Ensure an Analysis type of **Structural** is set.
- Select an Analysis Category of **3D**
- Set Model units of **N,mm,t,s,C**
- Ensure Timescale units are in **Seconds**
- Select a Startup template of **Composite**
- Ensure the Layout grid is set as **None**
- Enter a Title of **Composite Strip - Shell Model**
- Click the **OK** button.

The Attributes  treeview will be populated with potentially useful basic line mesh, geometric and support entries appropriate to the settings made on the new model dialog.



Note. Save the model regularly as the example progresses. Use the Undo button to correct any mistakes made since the last save was done.

Defining the Geometry

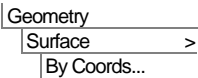

Enter coordinates of **(0,0)**, **(10,0)**, **(10,5)** and **(0,5)** and click **OK** to define the first Surface.

- Select the Line on the right hand side as shown.

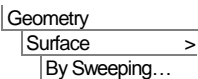
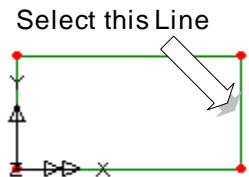

Enter a translation distance of **15** in the **X** direction.

- Click the **OK** button to create a new Surface.

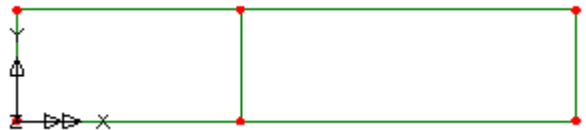

Meshing

The Surfaces are to be meshed using thick shell elements. LUSAS provides a composite surface mesh attribute by default. This can be seen in the  Treeview. A thick shell element (QTS4) is used.

Linear Analysis of a Composite Strip

- Select the whole model. (Using the **Ctrl** and **A** keys together).
- Drag and drop the surface mesh attribute **Composite Shell** from the  Treeview onto the selected features.

Modeller will draw a mesh based upon a default of 4 Line divisions per Line. This mesh density will be altered by using Line mesh datasets.

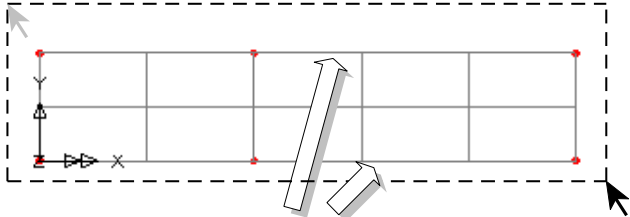

Note. A number of Line mesh attribute are provided by LUSAS by default. These can simply be dragged and dropped onto the features to which they are to be assigned.

- With the whole model selected, drag and drop the Line mesh attribute **Null, div = 2** from the  Treeview onto the selected features.
A diagram showing the selection of two lines for a mesh with 2 divisions. The mesh is a rectangle with 3 vertical lines and 3 horizontal lines. Two vertical lines on the right side are highlighted with a dashed box. A mouse cursor is pointing at the bottom right corner of the dashed box. A large white arrow points from the text 'Select these 2 Lines for Line meshk 'Divisions=3'' to the dashed box. Another large white arrow points from the text 'Select all Lines for Line mesh 'Divisions=2'' to the entire mesh area.

Select all Lines for Line mesh 'Divisions=2'

Select these 2 Lines for Line meshk 'Divisions=3'
- Select the 2 horizontal Lines on the right-hand side of the model. (Hold the Shift key down to add to the initial line selection).
- Drag and drop the Line mesh attribute **Null, div = 3** from the  Treeview onto the selected features. This overwrites the previous Line mesh assignment.

Checking Local Element Directions

In creating the second Surface from the first the orientation of the Surface axes will not necessarily be the same. In this example the local element directions should be checked because the composite lay-ups which are defined later in this example are assigned to the model using the local element axes.

Select the right-hand Surface of the model. Geometry



Use the isometric rotation button to rotate the model to a similar view to that shown.

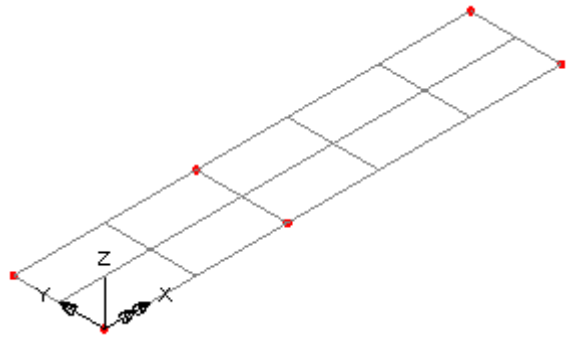

- In the  Treeview double click **Mesh** and select the **Show element axes** option.
- Click the **OK** button to display the element axes.
- The element axes in the right-hand section of the model need to be re-oriented to lie along the global X axis. But it can also be seen from the element axes that the surface first needs to be reversed.

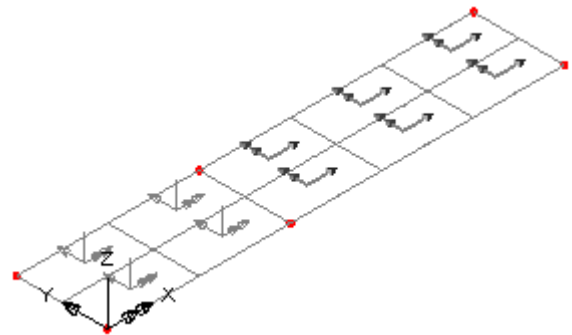

Changing the Element Directions

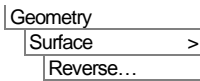

The surface orientation is now correct - all three of the element axes can now be seen.

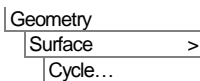

The orientation of the elements needs to be rotated to align them with the global X axis.

- Click **Apply** to rotate the axis by 90 degrees each time, until the x axis match with those of the left-hand surface.

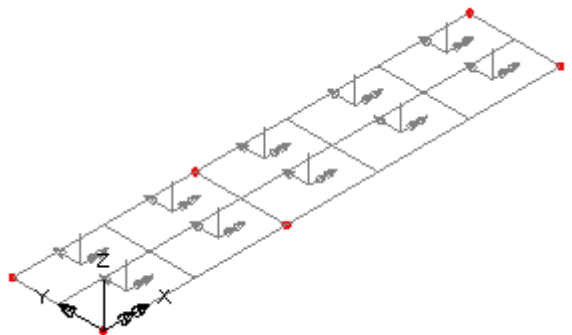

Linear Analysis of a Composite Strip

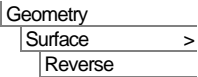

The orientation of the elements will rotate to align the with the global Y axis.

In the  Treeview double click the **Mesh** layer.

- De-select the **Show element axes** option and click the **OK** button.

Defining the Geometric Properties

The strip is 1mm thick. A geometric property attribute of unity thickness is provided by default. This can be used to define the thickness of the Surfaces.

- Select the whole model and drag and drop the geometry attribute **Unit Thickness** from the  Treeview onto the selected features. If the fleshing option is turned on the assigned geometric property will be automatically visualised.



Select the fleshing on/off button to turn-off geometric property visualisation.



Note. Once assigned to the model, attributes such as geometric assignments may be visualised.

Defining the Composite Material Properties

The material properties of the strip will be modelled as a composite lay-up made up from eight laminae, with each defined as an orthotropic material. Whilst LUSAS provides a range of composite material types by default, this example is based upon a test study and requires specific material data to be defined.

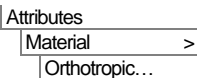

To define the orthotropic material:

- With the **Elastic** tab displayed, select a **Solid** model from the drop down list.
- Enter the Young's Modulus in the **X** direction as **1E5**, in **Y** as **5000** and in **Z** as **5000**
- Enter the shear modulus in the **XY** plane as **3000**, and in **YZ** and **ZX** as **2000**
- Finally, enter Poisson's ratio as **0.4** in the **XY** plane, and **0.3** in the other two planes. It is not necessary to enter the mass density.
- Enter the attribute name as **Strip Material** and click the **OK** button to add the material attribute to the  Treeview. This will be assigned to the model later in the example.

Attributes
Composite...

Defining the Composite Lay-up Arrangement

- Select the **Solids and Shells** option and click **Next**
- Ensure that the **Normal** tab is displayed for shells and solids.
- Select the **New** button to enter the composite lay-up details.

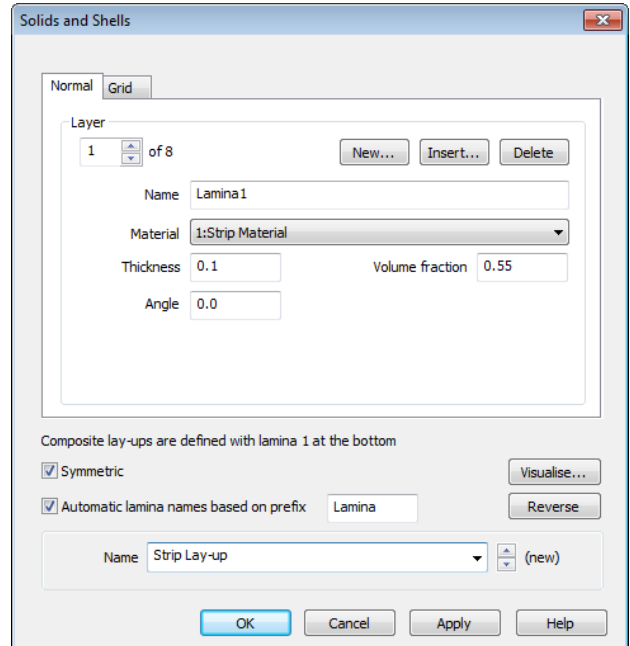

The Add Lamina dialog will appear.

Composite layup details

Details of the composite stack are shown in the attached table. The stack is symmetrical about the mid plane. This enables the input of the stack to be reduced by using the symmetric option.

Lamina Name	Thickness	Angle
Lamina1	0.1	0
Lamina2	0.1	90
Lamina3	0.1	0
Lamina4	0.2	90

Defining lamina 1

The Name for the first lamina will be automatically entered as **Lamina1**

The material will automatically be entered as **Strip material**

- Change the lamina thickness to **0.1**
- Enter the angle as **0**
- Click the **Apply** button to define lamina 1

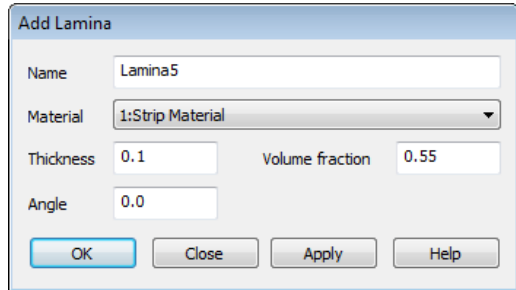

Defining laminae 2,3 and 4

- Enter lamina 2, 3 and 4 in a similar manner using the values in the preceding table, noting that the angle of orientation changes for each lamina, and that layer 4 has a different thickness to the other layers. Click **Apply** after each lamina is defined. s. Click **OK** when all are defined.
- On the Solids and Shells dialog select the **Symmetric** option.
- Enter the composite attribute name as **Strip Layup**

Checking the layup details

Now check the composite input:

- On the Composite Materials dialog, select the **Grid** tab.
- Ensure that the values are as shown. Correct on this grid if necessary.

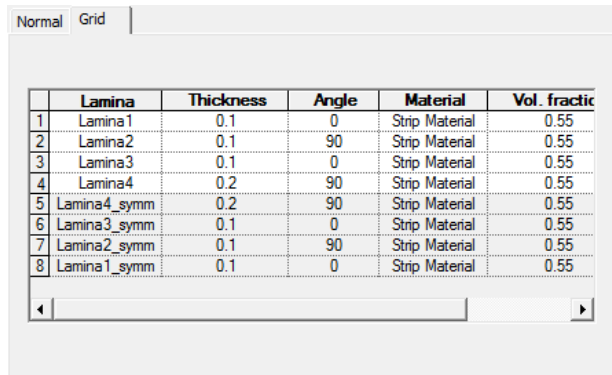

	Lamina	Thickness	Angle	Material	Vol. fractic
1	Lamina1	0.1	0	Strip Material	0.55
2	Lamina2	0.1	90	Strip Material	0.55
3	Lamina3	0.1	0	Strip Material	0.55
4	Lamina4	0.2	90	Strip Material	0.55
5	Lamina4_symm	0.2	90	Strip Material	0.55
6	Lamina3_symm	0.1	0	Strip Material	0.55
7	Lamina2_symm	0.1	90	Strip Material	0.55
8	Lamina1_symm	0.1	0	Strip Material	0.55



Note. Whilst this example shows laminate thicknesses being defined that sum-up to the geometric thickness

of the strip, lamina thicknesses for shell models that have been assigned a geometric thickness are actually relative values, not absolute, and represent the proportion of the total thickness (as specified by geometric surface properties) apportioned to each lamina.

Visualising the Composite Lay-up arrangement

- On the Solids and Shells dialog, select **Visualise** to view the lay-up sequence.
- Click the **Close** button to return to the Composite Materials dialog.
- Click the **Finish** button to add the composite material attribute to the  Treeview.



Note. The lay-up sequence always builds from the bottom to the top. In this example, Lamina1 is the bottom lamina in the stack.



Note. Composite lay-up data may also be defined in external spreadsheets for copying and pasting into the composite layup Grid using the standard copy (Ctrl + C) and paste (Ctrl + V) keys.

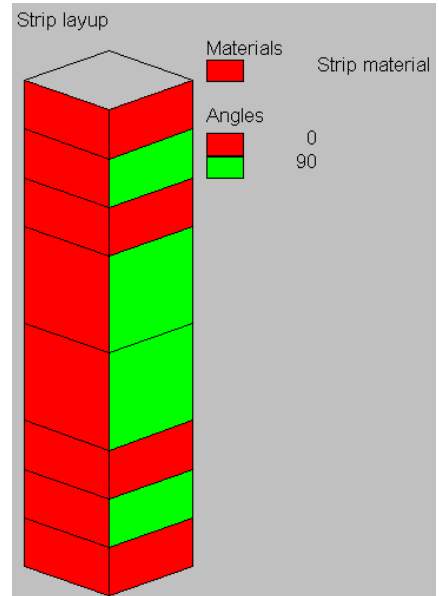

Assigning the Composite Lay-up Arrangement

- Drag a box around the model to select all the features (or press **Ctrl + A** keys)
- Drag and drop the attribute **Strip Lay-up** from the  Treeview onto the selected features.
- On the Assign Composite dialog, ensure that **Assign to Surfaces** and that **Local Element Axes** are selected.
- Click the **OK** button.



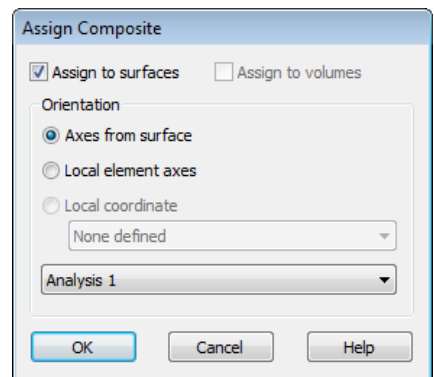

Note. In a composite analysis, assigning the composite material lay-up automatically assigns the material attribute to the model at the same time. The composite material attribute therefore does not have to be directly assigned to features.



Checking the composite orientation

To check the orientation of each composite lamina is correct.

- Select the  Treeview and double click on the **Attributes** entry to display the attribute layer properties.
- Select the **Composite** tab and select the **Strip Layup** check box option.
- Click on the **Settings** button and ensure the option to **Visualise ply directions** is selected.
- Click **OK** and **OK** again.
- In the  Treeview expand the Composite Strip layup entry and right-click on the lamina you wish to check and **Set Lamina Active**
- When you are satisfied the orientations are correct deselect this visualisation by selecting the  Treeview, double clicking on the **Attributes** entry, selecting the **Composite** tab and deselecting the **Strip Layup** option.

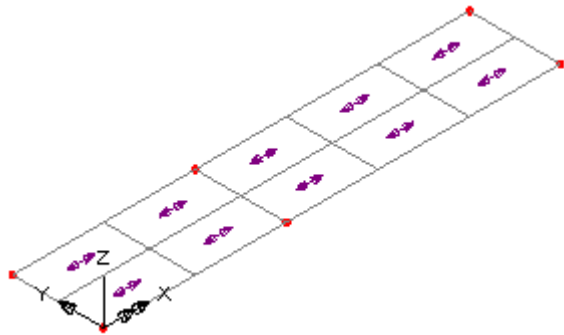

Supports

The more common types of support are provided by default. These can be seen in the  Treeview. The model will be supported in the Z direction at the internal Line between the two Surfaces.

- Select the internal Line **Select this Line for 'Fixed in Z' support** shown
- Drag and drop the support attribute **Fixed in Z** from the  Treeview onto the selected feature, click **OK** ensuring that it is assigned to **All analysis loadcases**

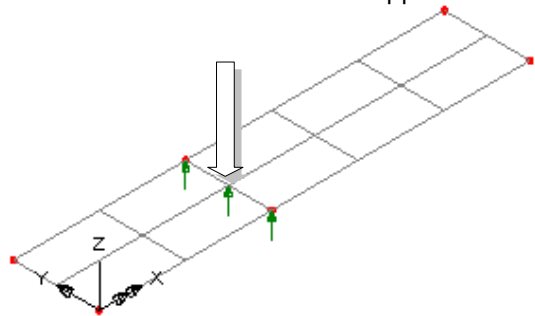



The supports will be visualised.

Defining Symmetry Support Conditions

LUSAS provides symmetry boundary conditions by default. These can be seen in the  Treeview. As only a quarter of the structure has been modelled the symmetry boundary conditions are assigned to two sides of the model.

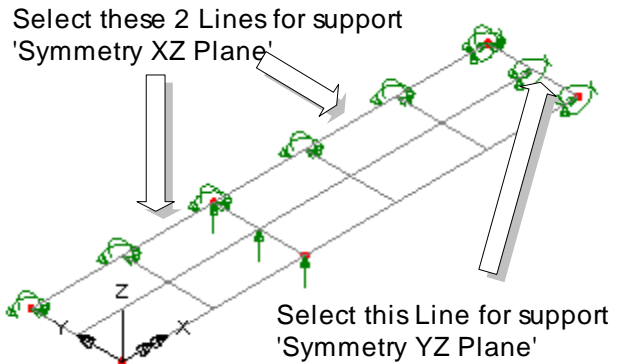
- Select the 2 upper Lines of the model as shown
- Drag and drop the support attribute **Symmetry XZ** from the  Treeview onto the selected features.



- Click **OK** to visualise the supports.
- Select the right-hand Line of the model as shown.
- Drag and drop the support attribute **Symmetry YZ** from the  Treeview onto the selected Line.
- Click **OK** to visualise the supports.

Loading

The model will be subjected to a load per unit length of 5 N/mm acting in the negative Z direction along the right-hand line which represents the mid-span centre-line of the strip.





Note. The composite strip is modelled using a quarter model and the Line of load application coincides with one of the Lines of symmetry. The value of applied load is therefore half of that applied to the full model.

- Select the **Global Distributed** option and click **Next**
- On the Global Distributed dialog select the **Per Unit Length** option.
- Enter a value of **-5** in the **Z** direction.

Attributes
Loading...

Linear Analysis of a Composite Strip

- Enter the attribute name as **Global Distributed**
- Click the **Finish** button to add the loading attribute to the  Treeview.
- Select the Line on the right of the model as shown.
- Drag and drop the loading attribute **Global Distributed** from the  Treeview onto the selected Line.
- Click the **OK** button to assign the load to the selected Lines and to accept the default loadcase.

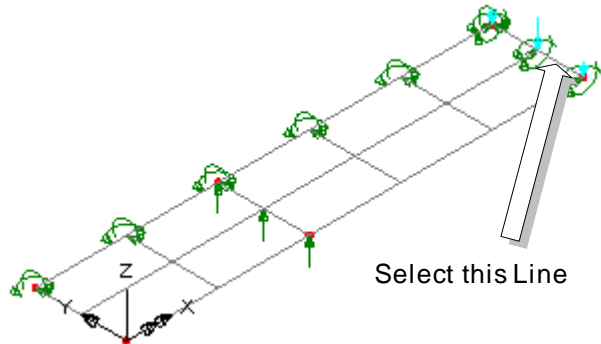

The loading will be visualised.

Saving the model

The model is now complete and the model data must be saved.



Save the model file.

Running the Analysis



Open the **Solve Now** dialog and click **OK** to run the analysis.

A LUSAS Datafile will be created from the model information. The LUSAS Solver uses this datafile to perform the analysis.

If the analysis is successful...

Analysis loadcase results are added to the  Treeview.

In addition, 2 files will be created in the Associated Model Data directory where the model file resides:



- **strip_shell.out** this output file contains details of model data, assigned attributes and selected statistics of the analysis.
- **strip_shell.mys** this is the LUSAS results file which is loaded automatically into the  Treeview to allow results processing to take place.

If the analysis fails...

If the analysis fails, information relating to the nature of the error encountered can be written to an output file in addition to the text output window. Any errors listed in the text output window should be corrected in LUSAS Modeller before saving the model and re-running the analysis.

Rebuilding a Model

If it proves impossible for you to correct the errors reported a file is provided to enable you to re-create the model from scratch and run an analysis successfully.



- **strip_shell_modelling.vbs** carries out the modelling of the example.

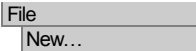

Start a new model file. If an existing model is open Modeller will prompt for unsaved data to be saved before opening the new file.

- Enter the file name as **strip_shell**

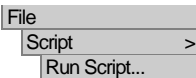

To recreate the model, select the file **strip_shell_modelling.vbs** located in the **<LUSAS Installation Folder>\Examples\Modeller** directory.



Rerun the analysis to generate the results

Viewing the Results



Analysis loadcase results are present in the  Treeview.

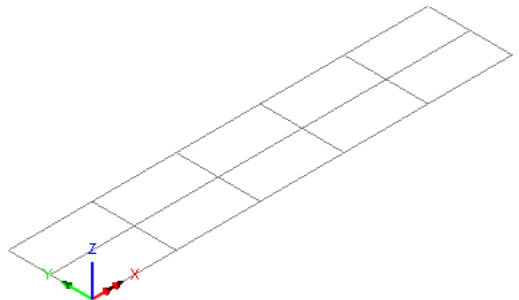

If necessary, use the isometric rotation button to rotate the model to a similar view to that shown.



Plotting peak vertical displacements

- In the  Treeview turn off the **Attributes**, **Deformed Mesh** and **Geometry** layers by right-clicking on the layer name and selecting the **On/Off** menu item.
- With no features selected click the right-hand mouse button in a blank part of the View window and select **Values** to add the Values layer to the  Treeview.

The values properties dialog will be displayed.

- With the **Value Results** tab selected, select entity results for **Displacement** of component **DZ**. (Displacement in the Z direction).
- Select the **Values Display** tab, deselect **Maxima** and specify that **0** % of the **Minima** displacement values are to be plotted
- Click the **OK** button to display peak values of vertical displacement.
- Turn off the **Values** layer in the  Treeview.

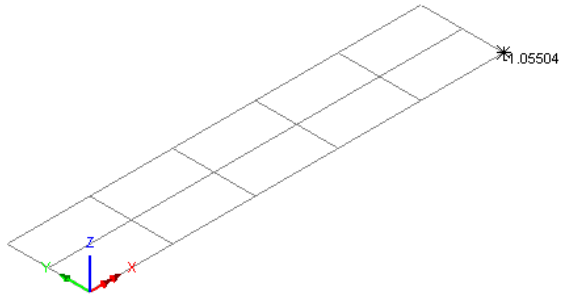

Stress contour plots for lamina



Note. For shell models the lamina results are output for the middle of each lamina selected.

- Click the right-hand mouse button in a blank part of the view window and select **Contours** to add the contours layer to the  Treeview.

The Contour Properties dialog will be displayed.

- Select the **Stress** entity of stress **Sx**







Note. By default, the stresses will be calculated in the lamina material direction. The **Transform** button in the  Treeview can be used to transform stresses into global or user defined directions.

- Click the **OK** button to display contours and the associated contour key.

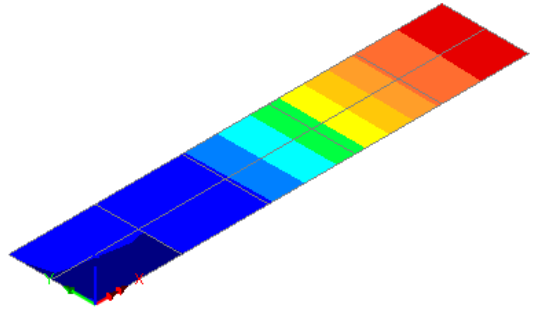
- In the  Treeview, in the Composite Strip Layup section, right-click on **Lamina1** and **Set Lamina Active**.

The contour key will show a maximum value of 519.1



- To display the mesh on top of the contours select the **Mesh** entry in the  Treeview and drag and drop it on top of the **Contour** entry in the  Treeview.
- By selecting different lamina from the Composite Strip layup entry in the  Treeview, the stresses throughout the composite strip can be investigated.



Note. Because there are discontinuities between laminae, the stress plots produced will always be for un-averaged results.

Interlamina shear plots

- In the  Treeview double-click the **Contours** layer to display the contour layer properties.
- Select the **Stress** entity of stress **Szx**
- Click the **OK** button to display contours and the associated contour key for the active lamina.

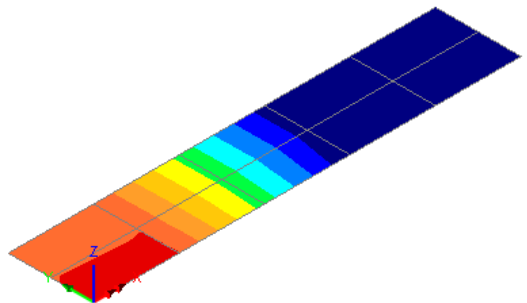

Modelling : Solid Model

The composite strip in this example is now to be modelled using solid composite brick elements meshed onto Volumes. This is to compare the accuracy of the results obtained for each modelling method.

Linear Analysis of a Composite Strip

If successfully created in the first part of this example, the shell composite model can be extended to create the solid composite model. If the model was not successfully created a suitable model can be built from a supplied file. See below for details.

Extending the current shell model



To continue directly from the shell model, selecting this menu item, or pressing this toolbar button, ensures the Mesh Lock option is deselected. Click **Yes** to confirm the closing of the results files.

- Enter the model file name as **strip_solid** and click the **Save** button.
- Ensure that only the **Geometry**, **Attributes** and **Mesh** layers are present and turned on in the Treeview.

Creating a suitable model from a supplied file



Start a new model file. If an existing model is open, Modeller will prompt for unsaved data to be saved before opening the new file.

- Enter the file name as **strip_solid**

To recreate the model, import the file **strip_shell_modelling.vbs** located in the **<LUSAS Installation Folder>\Examples\Modeller** directory.

Changing the model description

- Change the model description to **Composite strip - solid model** and click **OK**

Converting the Model from Shells to Solids

To convert the 2D model that uses Surfaces into a 3D model that uses Volumes a number of attributes assigned to the 2D model need to be deassigned. This is to prevent them being copied when the Surfaces are swept to create a 3D model.





Note. In the following tasks, take care to only deassign and NOT DELETE the Loading, Support attribute, Composite strip lay-up attribute or the Geometric material attribute from the Treeview.

Deassigning the loading

- In the Treeview click the right-hand mouse button on the loading attribute **Global Distributed** and select **Deassign>From all**

Deassigning the supports

- In the  Treeview, click the right-hand mouse button on the support attribute **Fixed in Z**, and select **Deassign>From all**
- In the  Treeview, click the right-hand mouse button on the support attribute **Symmetry XZ**, and select **Deassign>From all**.
- In the  Treeview, click the right-hand mouse button on the support attribute **Symmetry YZ**, and select **Deassign>From all**.

Deassigning the composite material arrangement

- Using the method described previously, deassign the composite attribute **Strip Layup** from the model.



Deassign the geometry

- Using the method described previously, deassign the geometry attribute **Unit Thickness** from all Surfaces on the model.

Deassigning the Surface mesh

- Using the method described previously, deassign the surface mesh attribute **Composite Shell** from the model.



Note. When an attribute is de-assigned from the model such that it is not used on any feature the assigned attribute symbol will change from its coloured form  to its unassigned grey form .

In the  Treeview the only assigned attribute left after this de-assignment process should be the Null, div = 2, and Null, div = 3 line mesh divisions, and the Strip Material.

Default mesh divisions

The Lines on the model have been assigned different Line mesh divisions earlier in the example. However, the default number of line mesh divisions is still set by default to be 4. If the existing surfaces were swept to create volumes any newly created lines between the top and bottom surfaces would have the default of 4 mesh divisions per line assigned to them when in fact only one mesh division per line is required.

To adjust the default number of mesh divisions:

- Select the **Meshing** tab. Set the default number of divisions to be **1** and click **OK**

Modifying the Geometry

The 2D model will now be swept into 3D by sweeping the existing two Surfaces to create two Volumes.

- Select the whole model.



Enter a translation in the **Z** direction of **1** and click **OK**



If necessary use the isometric rotation button to rotate the model as shown.

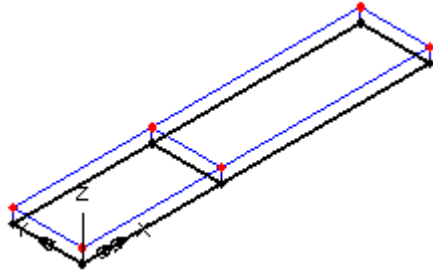

Geometry
Volume >
By Sweeping...



Note. With Composite analysis models the thickness of the volume defines the thickness of the strip and no geometric property thickness is required to be assigned to the model.

Whilst this example shows laminate thicknesses being defined that sum-up to the thickness of the volume, lamina thicknesses for solid models comprised of pentahedral and hexahedral composite elements are relative, not absolute, and represent the proportion of the total space that the elements of the volume represent apportioned to each lamina.

Meshing

A Volume mesh is to be defined. LUSAS provides a number of volume mesh attribute by default. These can be seen in the  Treeview. The composite brick element to be used has a hexahedral element shape and a quadratic interpolation order.

- Select the whole model.
- Drag and drop the Volume mesh attribute **Composite Brick (HX16L)** from the  Treeview onto the selected features.



Note. The Line mesh divisions (defined in the shell model of this example) are used to create the mesh arrangement for the top and bottom Surfaces. The default number of Line mesh divisions are used for each swept Line on the side Surfaces.

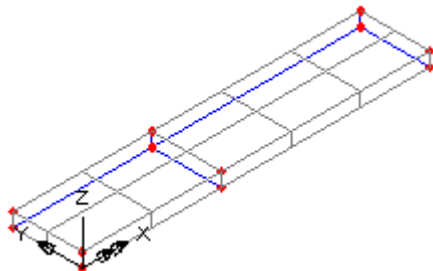

Assigning Composite Properties

- With the whole model selected, drag and drop the Composite material attribute **Strip Lay-up** from the  Treeview onto the selected features ensuring that it is assigned to **Volumes** using **Local element axes**. Click **OK** to carry out the assignment.



Note. The lamina thicknesses for solid models comprised of pentahedral and hexahedral composite elements are relative values, not absolute, and represent the proportion of the total space that the elements of the volume represent apportioned to each lamina.

Loading

- Select the upper Line shown right.
- Drag and drop the loading attribute **Global Distributed** from the  Treeview onto the selected feature and click **OK**

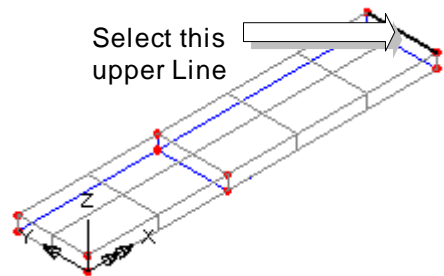

Supports

- Select the lower internal line as shown.
- Drag and drop the support attribute **Fixed in Z** from the  Treeview onto the selected feature, Click **OK** ensuring that **Assign to lines** is selected for **All loadcases**

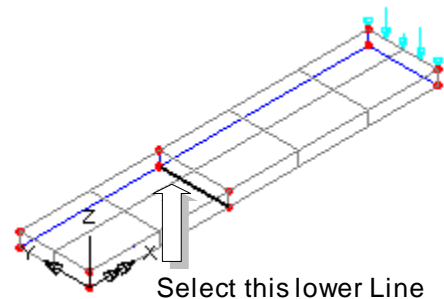

In order to model the boundary conditions the supports must be assigned to the Surfaces that are, in effect, axes of symmetry for the entire strip. These supports are easier to assign on a view along the global Z axis.

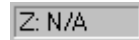
 Z: N/A

Set the view direction along the global Z axis by pressing the Z axis button on the status bar at the bottom of the view window.

Linear Analysis of a Composite Strip

- Drag a box around the 2 upper Surfaces of the model and drag and drop the support attribute **Symmetry XZ** from the  Treeview onto the selected features, Click **OK** ensuring that **Assign to surfaces** is selected for **All analysis loadcases**

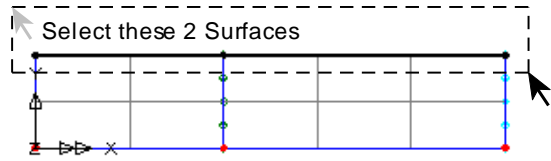

- Drag a box around the right-hand Surface of the model and drag and drop the support attribute **Symmetry YZ** from the  Treeview onto the selected features, Click **OK** ensuring that **Assign to surfaces** is selected for **All analysis loadcases**

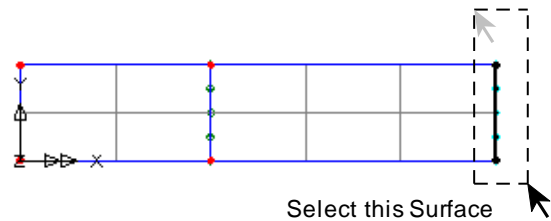

To view the applied supports use the isometric rotation button.

Save the model

The model is now complete.



Save the model file.

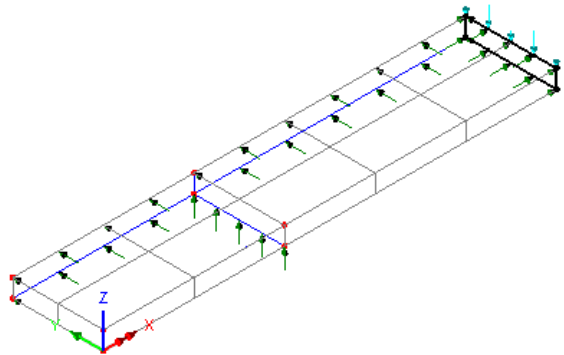

File _____
Save _____

Running the Analysis



Open the **Solve Now** dialog and press **OK** to run the analysis.

A LUSAS Datafile will be created from the model information. The LUSAS Solver uses this datafile to perform the analysis.

If the analysis is successful...

Analysis loadcase results are added to the  Treeview.

In addition, 2 files will be created in the Associated Model Data directory where the model file resides:



- strip_solid.out** this output file contains details of model data, assigned attributes and selected statistics of the analysis.
- strip_solid.mys** this is the LUSAS results file which is loaded automatically into the  Treeview to allow results processing to take place.

If the analysis fails...

Use a text editor to view the output file and search for 'ERROR'. Any errors listed in the output file should be fixed in LUSAS Modeller before saving the model and re-running the analysis.

Rebuilding the Model

If errors are listed that for some reason you cannot correct, a file is provided to recreate the model information correctly, allowing a subsequent analysis to be run successfully.



- strip_solid_modelling.vbs** carries out the modelling of the example.

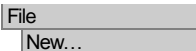

Start a new model file. If an existing model is open, Modeller will prompt for unsaved data to be saved before opening the new file.

- Enter the file name as **strip_solid**

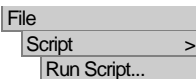

To recreate the model, select the file **strip_solid_modelling.vbs** located in the `\<LUSAS Installation Folder>\Examples\Modeller` directory.



Rerun the analysis to generate the results

Viewing the Results

- Ensure that only the **Geometry**, **Attributes** and **Mesh** layers are present and turned on in the  Treeview.



If necessary, use the isometric rotation button to rotate the model as shown.

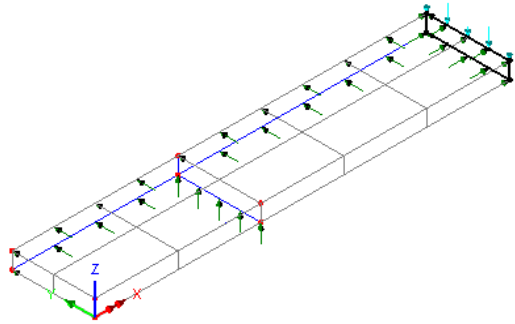

Plotting peak vertical displacements

- With no features selected click the right-hand mouse button in a blank part of the view window and select **Values** to add the values layer to the  Treeview.

The values properties dialog will be displayed.

- With the **Value Results** tab selected, select **Displacement** results of displacement in the **Z** direction, **DZ**
- Select the **Values Display** tab, de-select **Maxima** and specify that **0 %** of the **Minima** displacement values are to be plotted.
- Click the **OK** button to display the peak values of vertical displacement.
- Turn off the **Values** layer in the  Treeview.

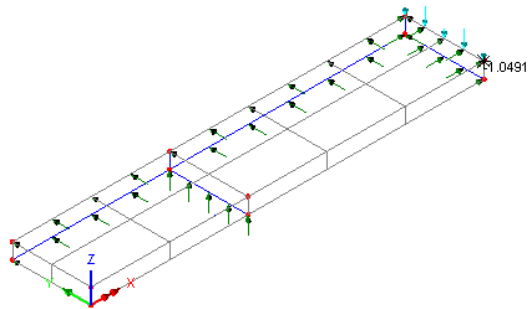

Stress contour plots for lamina



Note. For solid models the lamina results can be selected for the top, middle or the bottom of any selected lamina.

- With no features selected click the right-hand mouse button in a blank part of the view window and select **Contours** to add the contours layer to the  Treeview.

The contour Properties dialog will be displayed.

- Select entity results of **Stress (bottom)** of component **Sx** and click the **OK** button.
- In the  Treeview expand the Composite Strip Lay-up entry and right-click on the **Lamina1** and **Set Lamina Active**

The contour key should be showing a maximum stress in the lamina X direction of 679.4

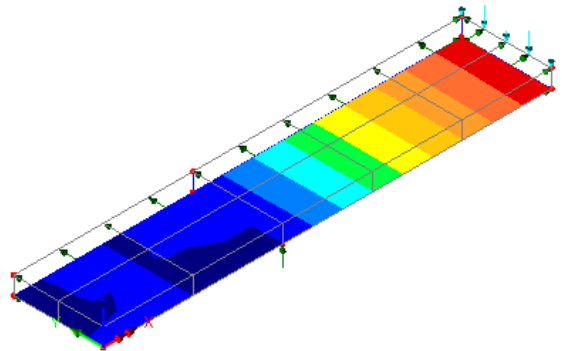

- By re-ordering the layers in the  Treeview the mesh can be viewed on top of the contour results.

Interlamina shear plots

- In the  Treeview double-click the **Contours** layer to display the contour layer properties.
- Select **Stress (top)** contour results of stress **Szx**
- Click the **OK** button to update the contours,

The contour key should be showing a minimum value of -8.06 for Lamina 1.

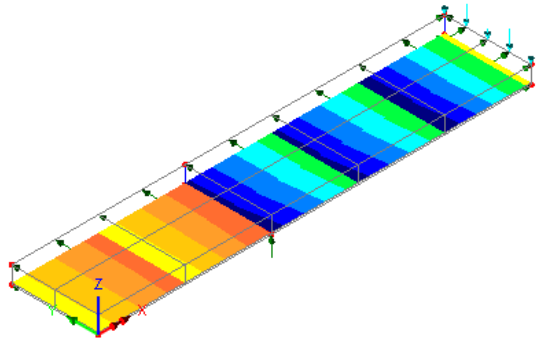

Defining Failure Strength

The failure strength dialog will appear.

- Enter the Dataset title as **Layer Strength**
- Enter the Longitudinal Tensile Strength as **1978**
- Enter the Transverse Tensile Strength as **48.69**
- Enter the Longitudinal Compressive Strength as **1978**
- Enter the Transverse Compressive Strength as **48.69**
- Enter the Shear Strength as **133**
- Leave the interaction type as **Default** and click **OK**

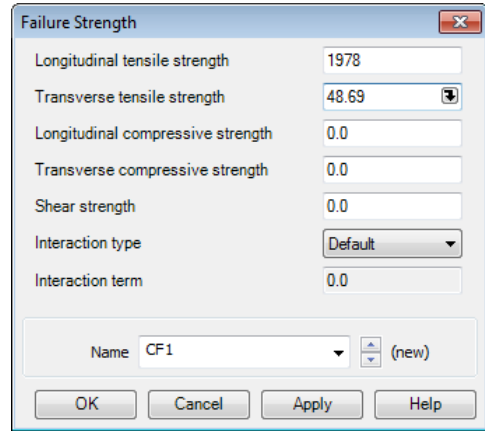

Property	Value
Longitudinal tensile strength	1978
Transverse tensile strength	48.69
Longitudinal compressive strength	0.0
Transverse compressive strength	0.0
Shear strength	0.0
Interaction type	Default
Interaction term	0.0

Name: CF1 (new)



Buttons: OK, Cancel, Apply, Help

Assigning Failure Strength

The failure strength is assigned to the geometry.

- Select the whole model.
- From the  Treeview drag and drop **Layer Strength** onto the selected features and click **OK** to **Assign to volumes**

Plotting contours of Failure Criteria

- Ensure that Composite strip layup **Laminate 1** is set active in the  Treeview .
- In the  Treeview double-click the **Contours** layer.
- Select **Stress (bottom)** contour results for entity **Tsai Wu**, for **Unaveraged nodal** results. By default, the stresses will be shown in the laminate material direction.
- Select the **Contour Display** tab and pick the **Contour Key Details** button, change the number of significant figures to **4** and deselect the **Show minimum value** option.

- Click **OK** to update the contour key details and **OK** again to display contours of the Tsai Wu failure criteria.



Note. Values greater than 1.0 would show that the material has exceeded the failure criteria.

In this example the maximum failure value for laminate 1 (as shown on the contour key) is only 0.26 so no failure has occurred due to the applied loading.

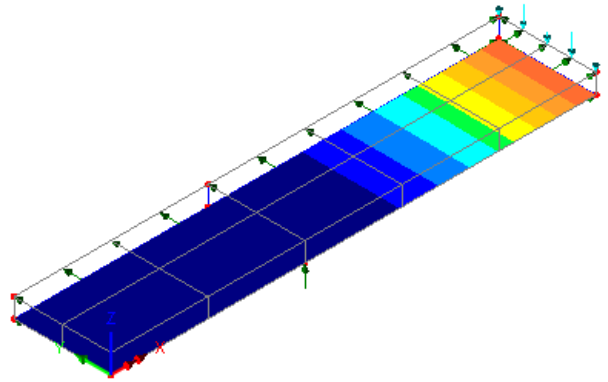

This completes the example.

