

A long-exposure photograph of a city at night, featuring a complex multi-level highway interchange with prominent light trails from traffic. The background is filled with illuminated skyscrapers and buildings, including a prominent tower with two spires on the left and a tower with a red and white sphere on the right. The sky is a deep twilight blue with some clouds.

LUSAS

Element
Reference Manual

Element Reference Manual

Version 19.1 Issue 1

LUSAS

Forge House, 66 High Street, Kingston upon Thames,
Surrey, KT1 1HN, United Kingdom

Tel: +44 (0)20 8541 1999

Fax +44 (0)20 8549 9399

Email: info@lusas.com

<http://www.lusas.com>

Distributors Worldwide

Copyright ©1982-2021 LUSAS

All Rights Reserved.

Table of Contents

Notation.....	1
Introduction.....	7
Overview.....	7
Element selection.....	7
Element uses.....	7
Element Groups.....	11
Element Sub-Groups.....	12
Element Types and Availability.....	12
Element Index.....	17
Element Summary Tables.....	43
Chapter 1 : Bar Elements.....	67
2D Structural Bar Elements.....	68
3D Structural Bar Elements.....	73
Chapter 2 : Beam Elements.....	79
2D Engineering Grillage Thick Beam Element.....	80
2D Thick Beam Elements.....	85
2D Thick Beam Element with Quadrilateral Cross-Section.....	94
3D Thick Beam Elements.....	102
3D Thick Beam Elements with Quadrilateral Cross-Section.....	112
3D Thick Beam Elements with Torsional Warping.....	122
3D Thick Beam Elements with Quadrilateral Cross-Section and Torsional Warping.....	132
2D Kirchhoff Thin Beam Elements.....	142
2D Kirchhoff Thin Beam Element with Quadrilateral Cross-Section.....	149
3D Kirchhoff Thin Beam Elements.....	157
3D Kirchhoff Thin Beam Element with Quadrilateral Cross-Section.....	164
3D Semiloof Thin Beam Elements.....	171
3D Semiloof Thin Beam Element with Quadrilateral Cross-Section.....	179
2D Plane Strain Beam Elements.....	186
Chapter 3 : 2D Continuum Elements.....	195
2D Plane Stress Continuum Elements.....	196
2D Plane Stress Continuum Element with Enhanced Strains.....	203
2D Plane Stress Continuum Crack Tip Elements.....	210
2D Plane Stress Explicit Dynamics Elements.....	216
2D Plane Strain Continuum Elements.....	221
2D Plane Strain Continuum Element with Enhanced Strains.....	228
2D Plane Strain Continuum Element for Large Strains.....	235
2D Plane Strain Continuum Crack Tip Elements.....	240
2D Plane Strain Explicit Dynamics Elements.....	246
2D Plane Strain Two Phase Continuum Elements.....	251
2D Axisymmetric Solid Continuum Elements.....	257
2D Axisymmetric Solid Continuum Element with Enhanced Strains.....	264
2D Axisymmetric Solid Continuum Element for Large Strains.....	270
2D Axisymmetric Solid Continuum Crack Tip Elements.....	275
2D Axisymmetric Solid Explicit Dynamics Elements.....	281
2D Axisymmetric Solid Two Phase Continuum Elements.....	287
2D Axisymmetric Fourier Ring Elements.....	293
Chapter 4 : 3D Continuum Elements.....	299
3D Solid Continuum Elements.....	300
3D Solid Continuum Element with Enhanced Strains.....	307
3D Solid Continuum Crack Tip Elements.....	314
3D Solid Continuum Composite Elements (Tetrahedral).....	321
3D Solid Continuum Composite Elements (Pentahedral and Hexahedral).....	328
3D Solid Continuum Explicit Dynamics Elements.....	335

3D Solid Two Phase Continuum Elements	341
Chapter 5 : Plate Elements.....	349
2D Isoplex Thin Plate Flexure Elements	350
2D Isoplex Thick Plate Flexure Element	354
2D Mindlin Thick Plate Flexure Element	358
Chapter 6: Shell Elements.....	363
2D Axisymmetric Thin Shell Element.....	364
2D Axisymmetric Thick Shell Elements	371
3D Flat Thin Shell Elements.....	378
3D Flat Thin Nonlinear Shell Element	384
Semiloof Curved Thin Shell Elements	391
3D Thick Shell Elements	400
Chapter 7 : Membrane Elements.....	411
2D Axisymmetric Membrane Elements	412
3D Space Membrane Elements.....	417
Chapter 8 : Joint Elements.....	423
2D Joint Element for Bars, Plane Stress and Plane Strain	424
2D Joint Element for Engineering and Kirchhoff Beams	428
2D Joint Element for Grillage Beams and Plates	433
2D Joint Element for Axisymmetric Solids	437
2D Joint Element for Axisymmetric Shells	442
3D Joints for Bars, Solids and Space Membranes	447
3D Joints for Semiloof Shells	452
3D Joint Elements for Engineering, Kirchhoff and Semiloof Beams	457
3D Joint Element for Semiloof Beams	462
Chapter 9 : Thermal / Field Elements.	467
2D Bar Field Elements.....	468
2D Axisymmetric Membrane Field Elements.....	472
3D Bar Field Elements.....	476
2D Link Field Element	480
3D Link Field Element	483
2D Axisymmetric Link Field Element	486
2D Axisymmetric Field Elements	489
2D Plane Field Elements	494
3D Solid Field Elements.....	499
3D Solid Composite Field Element (Tetrahedral)	504
3D Solid Composite Field Elements (Pentahedral and Hexahedral)	509
Chapter 10 : Hygro-Thermal Elements.	515
2D Plane Hygro-Thermal Elements	516
2D Axisymmetric Solid Hygro-Thermal Elements	520
3D Solid Hygro-Thermal Elements	524
Chapter 11 : Interface Elements.....	529
2D Interface Element.....	530
2D Two Phase Interface Element.....	534
3D Interface Element.....	538
3D Two Phase Interface Element.....	543
Chapter 12 : Non-Structural Elements.....	547
2D Point Mass Element.....	548
3D Point Mass Element.....	551
3D Line Mass Elements.....	554
2D Line Mass Elements.....	557
Surface Mass Elements	560
Chapter 13 : Rigid Slideline Elements	563
Rigid Slideline Surface 2D Elements.....	564
Rigid Slideline Surface 3D Elements.....	567
Chapter 14 : Phreatic Elements	571
Phreatic Surface 2D Elements.....	572

Phreatic Surface 3D Elements.....	574
Appendix A : Element and Pressure Loads.....	577
ELDS Element Loads.....	577
ENVT/TDET Environmental Boundary Conditions.....	580
FLD Face loading applied to thermal bars.....	581
Face Loads On 2D Continuum Elements.....	581
Face Loads On 3D Continuum Elements.....	582
UDL Loads on Shells.....	585
Appendix B : Element Restrictions.....	587
Mid-side Node Centrality.....	587
Excessive Element Curvature.....	587
Excessive Aspect Ratios.....	587
Excessive Warping.....	588
Appendix C : Local Element Axes.....	589
Standard Joint Element.....	589
Standard Line Element.....	589
Standard Surface Element.....	589
Appendix D : Sign Conventions.....	591
Standard Bar Element.....	591
Standard Beam Element.....	591
Grillage Elements.....	592
2D Engineering Beam Elements.....	593
3D Engineering Beam Elements.....	595
Standard Beam Eccentricities.....	596
Standard 2D Continuum Element.....	597
Standard 3D Continuum Element.....	597
Standard Plate Element.....	597
Thin Shell Element.....	598
Thin Shell Eccentricity.....	599
Thick Shell Element.....	599
Thick Shell Eccentricity.....	601
Standard Membrane Element.....	601
Standard Field Element.....	602
Standard Joint Element.....	602
Appendix E : Thick Shell Notation.....	605
Thick Shell Nodal Rotation.....	605
Appendix F : Newton Coates Integration.....	609
Newton-Cotes Integration Points.....	609
Appendix G : Shear Area and Torsional Constant.....	611
Shear Areas.....	611
Torsional Constant.....	612
Appendix H : Principal Stress Output.....	615
Output Notation for Principal Stresses.....	615
Appendix I : Mass Lumping.....	617
Mass Lumping in LUSAS.....	617
Appendix J : Moments of Inertia.....	619
Moments of Inertia Definitions.....	619
Appendix K : Results Tables.....	621
Key to Element Results Tables.....	621
Key to Slideline Results Components.....	629
Transforming Results Directions.....	630
2D Structural Bars BAR2, BAR3.....	631
3D Structural Bars BRS2, BRS3.....	632
2D Engineering Grillage Thick Beam GRIL.....	633
2D Thick Beam Elements BMI2, BMI3, BMI2X, BMI3X.....	634
3D Thick Beam Elements BMI21, BMI22, BMI31, BMI33, BMX21, BMX22, BMX31, BMX33.....	635

3D Thick Beam Elements with Torsional Warping BMI21W, BMI22W, BMI31W, BMI33W, BMX21W, BMX22W, BMX31W, BMX33W	636
2D Kirchhoff Thin Beams BM3, BMX3.....	637
3D Kirchhoff Thin Beams BS3, BS4, BSX4	638
3D Semiloof Thin Beams BSL3, BSL4, BXL4.....	639
Plane Strain Beam Elements BMI2N, BMI3N	640
2D Continuum (Plane Stress) TPM3/6, QPM4/8, QPM4M, TPK6, QPK8	641
2D Continuum Plane Stress (Explicit Dynamics) TPM3E, QPM4E	642
2D Continuum (Plane Strain) TPN3/6, QPN4/8, TNK6, QNK8, QPN4M	643
2D Continuum (Plane Strain) QPN4L	644
2D Plane Strain Two Phase Continuum TPN6P, QPN8P	645
2D Continuum Plane Strain (Explicit Dynamics) TPN3E, QPN4E	646
2D Continuum Axisymmetric Solid (Explicit Dynamics) TAX3E, QAX4E.....	647
2D Axisymmetric Solid Two Phase Continuum TAX6P, QAX8P	648
2D Continuum Axisymmetric Solid Fourier TAX3/6F, QAX4/8F	649
Axisymmetric Solid TAX3/6, QAX4/8, QAX4M, TXK6, QXK8	650
Axisymmetric Solid Large Strain QAX4L	651
3D Solid Continuum TH4/10, TH10S, PN6/12/15, PN6L/12L, HX8/16/20, HX8M, HX8L/16L, TH10K, PN15K, HX20K.....	652
3D Solid Continuum Two Phase TH10P, PN12P, PN15P, HX16P, HX20P.....	653
3D Solid Continuum Explicit Dynamics TH4E, PN6E, HX8E	654
Isoflex Thin Plates TF3, QF4	655
Isoflex Thick Plates QSC4.....	656
Mindlin Thick Plates TTF6, QTF8.....	657
2D Axisymmetric Membranes BXM2, BXM3	658
3D Space Membranes TSM3, SMI4	659
2D Thin Axisymmetric Shells BXS3	660
2D Thick Axisymmetric Shells BXS12, BXS13.....	661
3D Flat Thin Shells TS3, QSI4.....	662
3D Flat Thin Nonlinear Shell TSR6	663
Semiloof Shells TSL6, QSL8.....	664
3D Thick Shells TTS3, TTS6, QTS4, QTS8	665
2D Joints (for Bars, Plane Stress and Plane Strain) JNT3	666
2D Joints (for Engineering and Kirchhoff Beams) JPH3.....	667
2D Joints (for Grillage Beams and Plates) JF3.....	668
2D Joints (for Axisymmetric Solids) JAX3.....	669
2D Joints (for Axisymmetric Shells) JXS3	670
3D Joints (for general 3 dof connection) JNT4, JL43.....	671
3D Joints (for general 6 dof connection) JSH4, JL46.....	672
3D Joints (for Semiloof Element Mid-side Nodes) JSL4	673
Thermal Bars BFD2/3, BFS2/3, BFX2/3	674
Thermal Links LFD2, LFS2, LFX2	674
Plane and Axisymmetric Field TFD3/6, QFD4/8, TFX3/6, QXF4/8.....	674
Solid Field TF4/10, PF6/12/15, HF8/16/20, TF10S, PF6C/12C, HF8C/16C	674
Plane and Axisymmetric Hygro-Thermal THT3/6, QHT4/8, TXHT3/6, QXHT4/8.....	675
Solid Hygro-Thermal THT4/10, PHT6/12/16, HHT8/16/20	675
2D Interface Element IPN4, IPN6, IAX4, IAX6	677
2D Two Phase Interface Elements IPN6P, IPN8P	678
3D Interface Element IS6 IS8 IS12 IS16	679
3D Two Phase Interface Element IS12P, IS16P.....	680
Appendix L : Joint Element Compatibility.....	681
Joint Element Compatibility and Notes	681
Index.....	685

Notation

A	Cross sectional area
A_p	Plastic area
A_s, A_{sy}, A_{sz}	Effective shear area
A₁ ... A_n	Nodal cross sectional areas
ar	Mass Rayleigh damping constant
α	Coefficient of thermal expansion
α_s	Softening parameter
α_x, α_y, α_z, α_{xy}, α_{xz}, α_{yz}	Orthotropic thermal expansion coefficients
α_x, α_y, α_z	Angular accelerations
br	Stiffness Rayleigh damping parameter
β	Shear retention factor/parameter
β	Principal stresses direction
C	Specific heat capacity
C_i	(i)th hardening stiffness
C₀	Neo-Hookean rubber model constant
C₁, C₂	Mooney-Rivlin rubber model constants
c	Cohesion
co	Initial cohesion
D_{ij}	Rigidity coefficients
du, dq	Relative displacement, rotation
E	Modulus of elasticity (Young's modulus)

Ep	Elasto-plastic modulus
Ex, Ey, Ez	Orthotropic moduli of elasticity
ep	Strain at peak compressive strength
ey, ez	Eccentricity
ex, ey, ez	Direct strains (local or global)
es	Maximum shear strain
ee	Von Mises equivalent strain
ec	Creep strains
ep	Equivalent plastic strain
Fx, Fy, Fz	Forces (local or global)
Fyld	Yield force
F	Deformation gradient
fc'	Compressive strength of concrete
ft'	Tensile strength of concrete
ψx, ψy, ψz	Flexural (bending) strain resultants
ψxy, ψxz, ψyz	Torsional strain resultants
G	Shear modulus
Gf	Fracture energy
Gxy, Gxz, Gyz	Orthotropic shear moduli
γx, γy, γz	Membrane strain resultants
γx, γy, γz	Field gradients (local or global)
H	Enthalpy
Hi1	Isotropic hardening parameter
Hk1	Kinematic hardening parameter
hc	Convective heat transfer coefficient
hf	Heat fraction
hr	Radiative heat transfer coefficient

$\theta_x, \theta_y, \theta_z$	Rotations (local or global)
θ_1, θ_2	Loof node rotations (local)
$\theta_\alpha, \theta_\beta$	Nodal rotations for thick shells
θ_λ	Angle defining principal directions of λ_1, λ_2
I_y, I_z	1st moments of inertia
I_{yy}, I_{zz}	2nd moments of inertia
I_{yz}	Product moment of inertia
J	Volume ratio (determinant of F)
K	Spring stiffness
K_c	Contact stiffness
K_l	Lift-off stiffness
K_o	Original gap conductance
K_t	Torsional constant
k	Thermal conductivity
k_x, k_y, k_z	Orthotropic thermal conductivities
k_r	Bulk modulus
κ	Hardening stiffness
L_i	Limit of (i)th hardening stiffness
$\lambda_1, \lambda_2, \lambda_3$	Principal stretches
M	Mass
M_x, M_y, M_z	Concentrated moments (local or global)
M_x, M_y, M_z, M_θ	Flexural moments (local or global)
M_{xy}, M_{xz}, M_{yz}	Torsional moments (local or global)
M₁, M₂	Concentrated loof moments (local or global)
m_x, m_y, m_z	Mass in element local directions
μ	Coulomb friction coefficient
μ_{ri}, α_{ri}	Ogden rubber model constants

- N_x, N_y, N_z, N_θ** Membrane resultants (local or global)
- N_x, N_y, N_{xy}** Stress resultants
- N_{max}, N_{min}** Principal stress resultants
 - N_s** Maximum shear stress resultant
 - N_e** Von Mises equivalent stress resultant
 - ν** Poisson's ratio
- ν_{xy}, ν_{xz}, ν_{yz}** Orthotropic Poisson's ratio
- P_x, P_y, P_z** Concentrated loads (global)
 - ρ** Mass density
 - Q** Field loading
 - q_a** Field face loading flux/unit area
 - q_v** Field volume loading flux/unit volume
- q_x, q_y, q_z** Field fluxes (local or global)
 - Q_H** Rate of internal heat generation per unit volume Rate of internal mass (liquid+vapour) generation per unit volume Heat flux
 - Q_w** Rate of internal heat generation per unit volume Rate of internal mass (liquid+vapour) generation per unit volume Heat flux
 - q_H** Rate of internal heat generation per unit volume Rate of internal mass (liquid+vapour) generation per unit volume Heat flux
 - q_s** Stress potential parameters
 - q_w** Mass (liquid+vapour) flux Relative humidity Initial relative humidity
 - RH** Mass (liquid+vapour) flux Relative humidity Initial relative humidity
 - RH₀** Mass (liquid+vapour) flux Relative humidity Initial relative humidity
 - S_p** Plastic shear area
 - σ_y** Yield stress

σ_{y0}	Initial uniaxial yield stress
$\sigma_x, \sigma_y, \sigma_z$	Direct stresses (local or global)
$\sigma_{max}, \sigma_{min}$	Principal stresses
$\sigma_{xy}, \sigma_{xz}, \sigma_{yz}$	Shear stresses (local or global)
σ_s	Maximum shear stress
σ_e	Von Mises equivalent stress
T	Temperature
T, T_0	Final, initial temperatures
$t_1 \dots t_n$	Nodal thicknesses
U, V, W	Displacements (global)
Φ	Field variable
Φ_e	External environmental temperature
ϕ	Frictional angle
ϕ_0	Initial frictional angle
ϕ	Body force potential
V_x, V_y, V_z	Nodal velocities (global)
$V_{11}, V_{12} \dots V_{33}$	Left stretch tensor components
W_x, W_y, W_z	Uniformly distributed intensities
X, Y, Z	Nodal coordinates (global)
$X_{cbf}, Y_{cbf}, Z_{cbf}$	Constant body forces (global)
X_0, Y_0, Z_0	Offsets of finite element model coordinate system from point about which global angular acceleration and velocities are applied
$y_1, z_1 \dots y_4, z_4$	Cross sectional coordinates (local)
Z_{yp}, Z_{zp}	Torsional plastic moduli
Z_{yy}, Z_{zz}	Flexural plastic moduli
ω	Frequency of vibration
$\Omega_x, \Omega_y, \Omega_z$	Angular velocities (global)

Introduction

Overview

The LUSAS *Element Reference Manual* describes the elements currently available in LUSAS Solver. It has been designed to be used in conjunction with the *Solver Reference Manual* and provides input/output information which is specific to each element type.

If you require:

- General theoretical information - refer to *Theory Manual Volume 1*
- Element related theoretical / formulation information - refer to *Theory Manual Volume 2*

Element selection

Details of typical [element uses](#) are provided and, to assist you with choosing an element for a particular modelling task, three alternative selection methods are available for selecting by:

- [Element type](#) - listing just element group, sub-group and element name
- [Element index](#) - showing element name, geometry, nodal freedoms and element availability
- [Element summary](#) - showing element names, material property, loading, nonlinear, integration, and mass modelling capabilities

Of these three methods, the element summary tables provide the most detail to enable correct element selection for a particular modelling task.

Element uses

The following brief descriptions of each element group are provided to assist you with element selection for a particular modelling task.

Additional more detailed and element-specific recommendations on use can be found by viewing the *Recommendations on Use* section provided within each element's listing. For an example see [3D Thick Beam Elements](#)

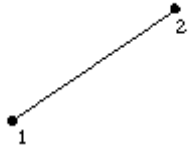
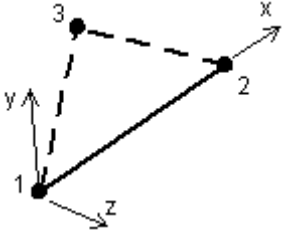
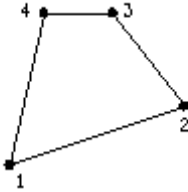
<p>Bar Elements</p> <p>Bar elements are used to model plane and space truss structures, cables in cable-stayed structures, and stiffening reinforcement.</p> <ul style="list-style-type: none"> • LUSAS incorporates 2 and 3-dimensional bar elements which may either be straight or curved. • Bar elements model <i>axial force</i> only. 	
<p>Beam Elements</p> <p>Beam elements are used to model plane frames, space frame structures, and cables in cable-stayed structures.</p> <ul style="list-style-type: none"> • LUSAS incorporates a variety of thin and thick beams in both 2 and 3-dimensions. In addition, specialised beam elements for modelling grillage or eccentrically ribbed plate structures are available. • LUSAS beam elements may be either straight or curved and may model <i>axial force</i>, <i>bending</i> and <i>torsional behaviour</i>. 	
<p>2D Continuum Elements</p> <p>2D continuum elements are used to model solid structures whose behaviour <i>may reasonably be assumed to be 2-dimensional</i>.</p> <ul style="list-style-type: none"> • 2D continuum elements may be applied to plane stress, plane strain and axisymmetric solid problems. • Triangular and quadrilateral elements are available. • Fourier elements, which allow non-axisymmetric loading to be applied to axisymmetric models, are considered a special case of the 2D continuum elements since the mesh is defined entirely in the xy-plane, but the resulting displacements, strains and stresses are fully three-dimensional. • Special crack tip elements are available to model the singularities encountered at crack opening • Explicit elements are available to model high speed dynamics problems efficiently. 	

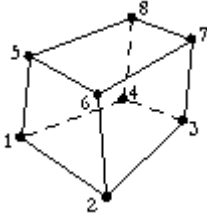
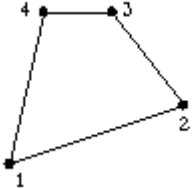
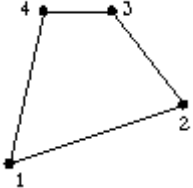
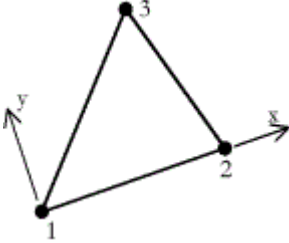
<p><u>3D Continuum Elements</u></p> <p>3D continuum elements are used to model <i>fully3-dimensional structures</i>.</p> <ul style="list-style-type: none"> • Tetrahedral, pentahedral and hexahedral solid elements are available to model full 3-dimensional stress fields. • Composites elements are available to model laminates. • Special crack tip elements are available to model the singularities encountered at crack opening 	
<p><u>Plate Elements</u></p> <p>Plate elements are used to model flat structures whose deformation can be assumed to be predominantly flexural</p> <ul style="list-style-type: none"> • LUSAS incorporates both thin and thick plate elements. • Triangular and quadrilateral flexural plate elements are available. 	
<p><u>Shell Elements</u></p> <p>Shell elements are used to model 3-dimensional structures whose behaviour is dependent upon both <i>flexural and membrane effects</i>.</p> <ul style="list-style-type: none"> • LUSAS incorporates both flat and curved shell elements. • Triangular and quadrilateral elements are available • Both thin and thick shell elements are available. 	
<p><u>Membrane Elements</u></p> <p>Membrane elements are used to model 2 and 3-dimensional structures whose behaviour is dominated by in-plane membrane effects.</p> <ul style="list-style-type: none"> • LUSAS incorporates both axisymmetric and space (3-dimensional) membrane elements. • Membrane elements incorporate <i>in-plane (membrane) behaviour only</i> (they include no bending behaviour). 	

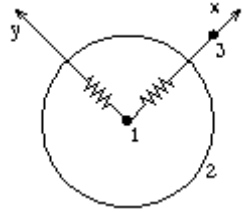
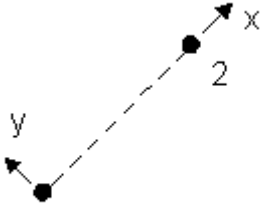
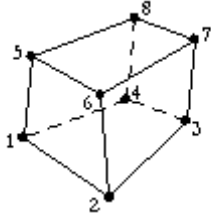
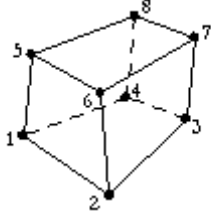
<p>Joint Elements</p> <p>Joint elements are used to model <i>flexible joints</i> between other LUSAS elements.</p> <ul style="list-style-type: none"> • LUSAS incorporates a variety of joint elements which are designed to match the nodal freedoms of their associated elements. • Joint elements may also be used to model point masses, elasto-plastic hinges, or smooth and frictional element contacts. 	
<p>Non-Structural Mass Elements</p> <p>Non-Structural Mass elements are used to model translational <i>mass</i> at a point, along an edge or on a surface.</p> <ul style="list-style-type: none"> • Non-Structural Mass elements must be used with other structural elements. 	
<p>Thermal / Field Elements</p> <p>Thermal / Field elements are used to model quasi-harmonic equation problems such as <i>thermal conduction</i> or potential distribution.</p> <ul style="list-style-type: none"> • LUSAS incorporates bar, plane, axisymmetric solid and 3-dimensional solid field elements. • Thermal link elements are also available. 	
<p>Hygro-Thermal Elements</p> <p>Hygro-thermal elements are used in <i>hygro-thermal</i> transient analyses, i.e. to model heat and moisture flow in porous media. The elements are generally used for problems involving the heat of hydration of concrete, and are normally used in a hygro-thermal-structural coupled analysis.</p> <ul style="list-style-type: none"> • LUSAS incorporates plane, axisymmetric solid and 3-dimensional solid hygro-thermal elements • Thermal link elements can also be used in a hygro-thermal analysis. 	

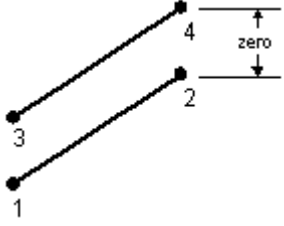
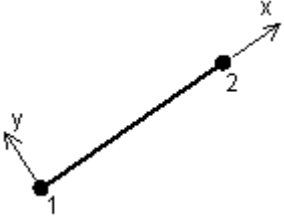
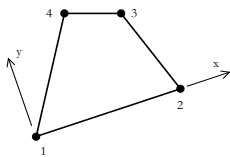
<p><u>Interface Elements</u></p> <p>Mohr-Coulomb interface elements are used to model the <i>contact behaviour</i> between two bodies. Delamination interface elements model <i>delamination</i> and <i>crack propagation</i> in composites. They are positioned at places of potential delamination between continuum elements</p>	
<p><u>Rigid Elements</u></p> <p>Rigid elements are used to define the shape of a rigid surface which is not part of the analysis model.</p>	
<p><u>Phreatic Surface Elements</u></p> <p>Phreatic surface elements are used to define the shape of a phreatic surface. They may be used with 2D and 3D continuum and two-phase elements.</p>	

Element Groups

The LUSAS Element Library is arranged into the following element groups:

- Bars
- Beams
- 2D Continuum elements
- 3D Continuum elements
- Plates
- Shells
- Membranes
- Joints
- Non-structural mass elements
- Thermal/Field elements
- Hygro-thermal elements
- Interface elements
- Rigid elements
- Phreatic surface elements

Element Sub-Groups

Each element group is also sub-divided into element sub-groups according to the type of element formulation as shown in the following [table](#). For example, the **Beam** element group contains the element sub-groups: Engineering beams, Thick beams, Kirchhoff beams and Semiloof beams.

Within each sub-group elements vary according to the geometry, the number of nodes, and the properties required by each element. The individual elements are referred to by their LUSAS name, for example: BMI21 or QTS4 .

Note

The dimensional classification of LUSAS elements is on the basis of the number of dimensions required for input of the nodal coordinates. For example, an engineering grillage element, (GRIL) requires X, Y coordinates and is hence classed as being 2-dimensional (despite having an out of plane displacement freedom).

Element Types and Availability

Element Group	Element Subgroup	Element Name and Software Product Version Availability		
		LT	Standard (S)	Plus (+)
Bars	Structural bars	BAR2 , BRS2	BAR3 , BRS3	
Beams	Engineering beams	GRIL		
	Plain strain beams		BMI2N , BMI3N	
	Thick beams	BMI2 , BMI21		BMI3 , BMI2X , BMI3X , BMI22 , BMI31 , BMI33 , BMX21 , BMX22 , BMX31 , BMX33
	Thick cross-section beams			BMI3 , BMI2X , BMI3X , BMI22 , BMI31 , BMI33 , BMX21 , BMX22 , BMX31 , BMX33

Element Group	Element Subgroup	Element Name and Software Product Version Availability		
		LT	Standard (S)	Plus (+)
	Warping beams			BMI21W , BMI22W , BMI31W , BMI33W , BMX21W , BMX22W , BMX31W , BMX33W
	Thin (Kirchhoff) beams		BM3 , BMX3	BS3 , BS4 , BSX4
	Semiloof beams			BSL3 , BSL4 , BXL4
2D Continuum	Plane stress continuum		TPM3 , TPM6 , QPM4 , QPM8 , QPM4M , TPK6 , QPK8	TPM3E , QPM4E
	Plane strain continuum		TPN3 , TPN6 , OPN4 , OPN8 , OPN4M , OPN4L , TNK6 , QNK8	TPN3E , OPN4E
	Plain strain two phase		TPN6P , QPN8P	
	Axisymmetric solid continuum		TAX3 , TAX6 , QAX4 , QAX8 , QAX4M , QAX4L , TXK6 , QXK8 , TAX3E , TAX6E , QAX4E , QAX8E	TAX3E , QAX4E

Element Group	Element Subgroup	Element Name and Software Product Version Availability		
		LT	Standard (S)	Plus (+)
	Axisymmetric solid two-phase			TAX6P , QAX8P
	Fourier ring			TAX3F , TAX6F , QAX4F , QAX8F
3D Continuum	Solid continuum		TH4 , PN6 , HX8 , HX8M	TH10 , PN12 , PN15 , HX16 , HX20 , TH10S , PN6L , PN12L , HX8L , HX16L , TH4E , PN6E , HX8E
	Solid continuum crack tip			TH10K , PN15K , HX20K
	Solid continuum two phase			TH10P , PN12P , PN15P , HX16P , HX20P
Plates	Isoflex plates		TF3 , QF4 , OSC4	
	Mindlin plates		TTF6 , QTF8	
Shells	Axisymmetric thin shells		BXS3	
	Axisymmetric thick shells		BXS12 , BXS13	
	Flat thin shells		TS3 , QSI4	TSR6 ,
	Semiloof shells			TSL6 , QSL8
	Thick shells		TTS3 , QTS4	TTS6 , QTS8
Membranes	Axisymmetric membranes		BXM2 , BXM3	
	Space membranes		TSM3 , SMI4	

Element Group	Element Subgroup	Element Name and Software Product Version Availability		
		LT	Standard (S)	Plus (+)
Joints	2D joints		JNT3 , JPH3 , JF3 , JAX3 , JXS3	
	3D joints		JNT4 , JL43 , JSH4 , JL46	JSL4
Field	Thermal bars		BFD2 , BFD3 , BFX2 , BFX3 , BFS2 , BFS3	
	Thermal links		LFD2 , LFX2 , LFS2	
	Plane field		TFD3 , TFD6 , QFD4 , QFD8	
	Axisymmetric field		TXF3 , TXF6 , QXF4 , QXF8	
	Solid field		TF4 , TF10 , PF6 , PF12 , PF15 , HF8	HF16 , HF20 , PF6C , PF12C , HF8C , HF16C , TF10S
Hygro-Thermal	Plane hygro-thermal			THT3 , THT6 , QHT4 , QHT8
	Axisymmetric hygro-thermal			TXHT3 , TXHT6 , QXHT4 , QXHT8
	Solid hygro-thermal			THT4 , THT10 , PHT6 , PHT12 , PHT15 , HHT8 , HHT16 , HHT20
Interface	2D Interface			IPN4 , IPN6 , IPM4 , IPM6 , IAX4 , IAX6
	2D Two-phase interface			IPN6P , IAX6P

Element Group	Element Subgroup	Element Name and Software Product Version Availability		
		LT	Standard (S)	Plus (+)
	3D Interface			IS6 , IS8 , IS12 , IS16
	3D Two-phase interface			IS12P , IS16P
Mass	Point Mass			PM2 , PM3
	Line Mass			LM2 , LM3 , LMS3 , LMS4
	Surface Mass			TM3 , TM6 , QM4 , QM8
Rigid Surface	2D Rigid			R2D2
	3D Rigid			R3D3 , R3D4
Phreatic Surface	2D		PHS2	
	3D		PHS3 , PHS4	

For details of the compatibility of joint elements with other elements see Appendix L : [Joint Element Compatibility](#)

Element Index



The following element index tables provide a diagrammatic index for each element with a description of the element, the nodal freedoms, and the software product version in which it is available.

The tables are listed in the following order:

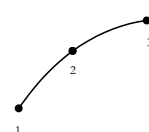
- [Bar elements](#)
- [Beam elements](#)
- [2D Continuum elements](#)
- [3D Continuum elements](#)
- [Plate elements](#)
- [Shell elements](#)
- [Membrane elements](#)
- [Joint elements](#)
- [Thermal / Field elements](#)
- [Hygro-Thermal elements](#)
- [Interface elements](#)
- [Non-Structural Mass elements](#)
- [Rigid elements](#)
- [Phreatic elements](#)

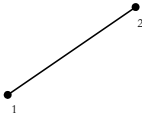
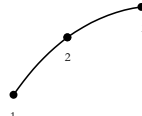
Bar Elements				
Name	Geometry	Title	Freedom	Product Version
BAR2		BAR element in 2D	U, V	LT
BAR3		BAR element in 2D	U, V	Standard

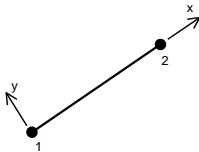
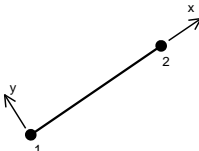
BRS2		BAR element in 3D	U, V, W	LT
BRS3		BAR element in 3D	U, V, W	Standard

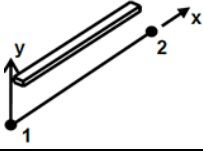
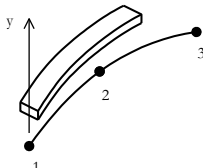
Beam Elements				
Name	Geometry	Title	Freedom	Product Version
GRIL		ENGINEERING grillage thick beam element in 2D	W, qx, qy	LT
BMI2		THICK beam element in 2D (co-rotational)	U, V, qz	LT
BMI3		THICK beam element in 2D (co-rotational)	U, V, qz	Plus
BMI2X		THICK beam element in 2D with quadrilateral cross-section (co-rotational)	U, V, qz	Plus
BMI3X		THICK beam element in 2D with quadrilateral cross-section (co-rotational)	U, V, qz	Plus

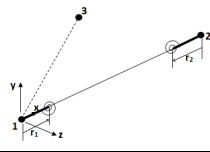
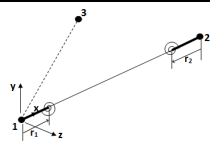
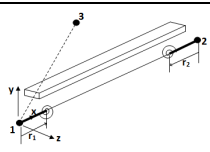
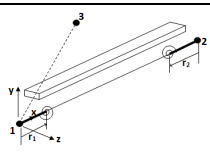
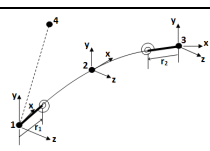
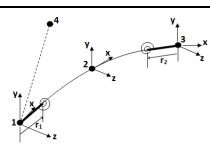
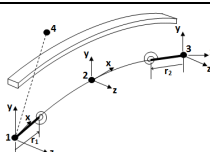
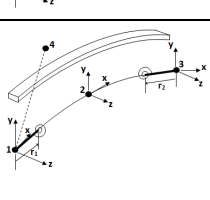

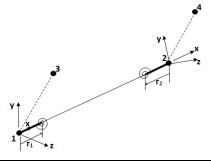
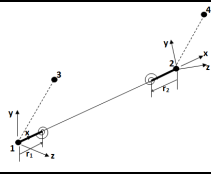
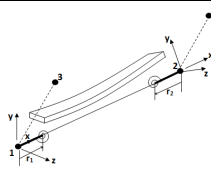
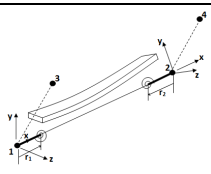
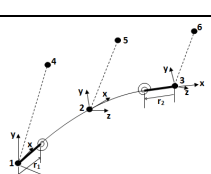
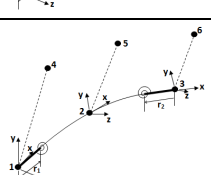
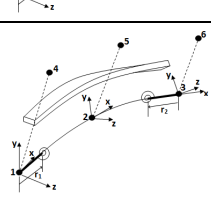

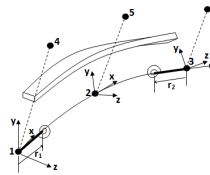
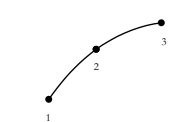
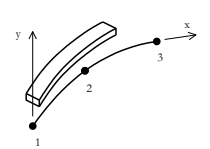
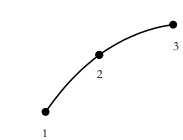
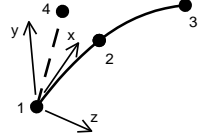
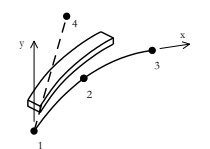
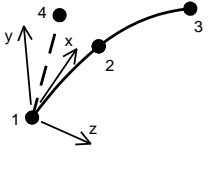
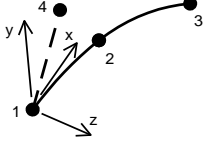
<p><u>BMI21</u></p>		<p>THICK linear thick beam element in 3D</p>	<p>U, V, W, qx, qy, qz</p>	<p>LT</p>
<p><u>BMI21W</u></p>		<p>THICK linear thick beam element with torsional warping in 3D</p>	<p>U, V, W, qx, qy, qz, α</p>	<p>Plus</p>
<p><u>BMX21</u></p>		<p>THICK linear thick beam element in 3D with quadrilateral cross-section</p>	<p>U, V, W, qx, qy, qz</p>	<p>Standard</p>
<p><u>BMX21W</u></p>		<p>THICK linear thick beam element with torsional warping in 3D with quadrilateral cross-section</p>	<p>U, V, W, qx, qy, qz, α</p>	<p>Plus</p>
<p><u>BMI31</u></p>		<p>THICK quadratic thick beam element in 3D</p>	<p>U, V, W, qx, qy, qz</p>	<p>Plus</p>
<p><u>BMI31W</u></p>		<p>THICK quadratic thick beam element with torsional warping in 3D</p>	<p>U, V, W, qx, qy, qz, α</p>	<p>Plus</p>
<p><u>BMX31</u></p>		<p>THICK quadratic thick beam element in 3D with quadrilateral cross-section</p>	<p>U, V, W, qx, qy, qz</p>	<p>Plus</p>
<p><u>BMX31W</u></p>		<p>THICK quadratic thick beam element with torsional warping in 3D with quadrilateral cross-section</p>	<p>U, V, W, qx, qy, qz, α</p>	<p>Plus</p>

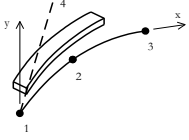
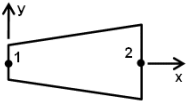
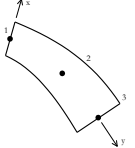
<p><u>BMI22</u></p>		<p>THICK twisted linear thick beam element in 3D</p>	<p>U, V, W, qx, qy, qz</p>	<p>Plus</p>
<p><u>BMI22W</u></p>		<p>THICK twisted linear thick beam element with torsional warping in 3D</p>	<p>U, V, W, qx, qy, qz, α</p>	<p>Plus</p>
<p><u>BMX22</u></p>		<p>THICK twisted linear thick beam element in 3D with quadrilateral cross-section</p>	<p>U, V, W, qx, qy, qz</p>	<p>Plus</p>
<p><u>BMX22W</u></p>		<p>THICK twisted linear thick beam element with torsional warping in 3D with quadrilateral cross-section</p>	<p>U, V, W, qx, qy, qz, α</p>	<p>Plus</p>
<p><u>BMI33</u></p>		<p>THICK twisted quadratic thick beam element in 3D</p>	<p>U, V, W, qx, qy, qz</p>	<p>Plus</p>
<p><u>BMI33W</u></p>		<p>THICK twisted quadratic thick beam element with torsional warping in 3D</p>	<p>U, V, W, qx, qy, qz, α</p>	<p>Plus</p>
<p><u>BMX33</u></p>		<p>THICK twisted quadratic beam element in 3D with quadrilateral cross-section</p>	<p>U, V, W, qx, qy, qz</p>	<p>Plus</p>

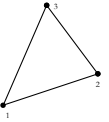
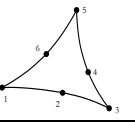
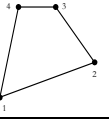
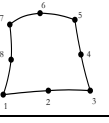
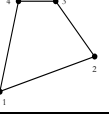
<p><u>BMX33W</u></p>		<p>THICK twisted quadratic beam element with torsional warping in 3D with quadrilateral cross-section</p>	<p>U, V, W, qx, qy, qz, α</p>	<p>Plus</p>
<p><u>BM3</u></p>		<p>KIRCHHOFF thin beam element in 2D</p>	<p>end nodes: U, V, qz mid-node: dU</p>	<p>Standard</p>
<p><u>BMX3</u></p>		<p>KIRCHHOFF thin beam element in 2D with quadrilateral cross-section</p>	<p>end nodes: U, V, qz mid-node: dU</p>	<p>Standard</p>
<p><u>BS3</u></p>		<p>KIRCHHOFF thin beam element in 3D</p>	<p>end nodes: U, V, W, qx, qy, qz mid-node: dU, dqx</p>	<p>Plus</p>
<p><u>BS4</u></p>		<p>KIRCHHOFF thin beam element in 3D</p>	<p>end nodes: U, V, W, qx, qy, qz mid-node: dU, dqx</p>	<p>Plus</p>
<p><u>BSX4</u></p>		<p>KIRCHHOFF thin beam element in 3D with quadrilateral cross-section</p>	<p>end nodes: U, V, W, qx, qy, qz mid-node: dU, dqx</p>	<p>Plus</p>
<p><u>BSL3</u></p>		<p>SEMILOOF thin beam element in 3D for use with TSL6</p>	<p>end nodes: U, V, W, qx, qy, qz mid-node: U, V, W, q1, q2</p>	<p>Plus</p>
<p><u>BSL4</u></p>		<p>SEMILOOF thin beam element in 3D for use with QSL8</p>	<p>end nodes: U, V, W, qx, qy, qz mid-node: U, V, W, q1, q2</p>	<p>Plus</p>

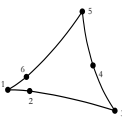
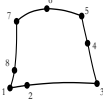
BXL4		SEMILOOF thin beam element in 3D with quadrilateral cross-section	end nodes: U, V, W, qx, qy, qz mid-node: U, V, W, q1, q2	Plus
BMI2N		Plane strain beam (co-rotational)	U, V, qz,	Standard
BMI3N		Plane strain beam (co-rotational)	U, V, qz,	Standard

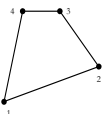
2D Continuum Elements				
Name	Geometry	Title	Freedoms	Product Version
TPM3		PLANE STRESS continuum element in 2D	U, V	Standard
TPM6		PLANE STRESS continuum element in 2D	U, V	Standard
QPM4		PLANE STRESS continuum element in 2D	U, V	Standard
QPM8		PLANE STRESS continuum element in 2D	U, V	Standard
QPM4M		PLANE STRESS continuum element in 2D with enhanced strains	U, V	Standard

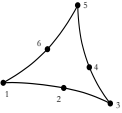
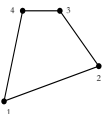
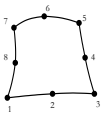
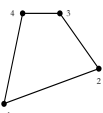
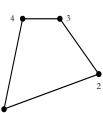
<u>TPK6</u>		PLANE STRESS continuum crack tip element in 2D	U, V	Standard
<u>QPK8</u>		PLANE STRESS continuum crack tip element in 2D	U, V	Standard
<u>TPM3E</u>		PLANE STRESS explicit dynamics element in 2D	U, V	Plus
<u>QPM4E</u>		PLANE STRESS explicit dynamics element in 2D	U, V	Plus
<u>TPN3</u>		PLANE STRAIN continuum element in 2D	U, V	Standard
<u>TPN6</u>		PLANE STRAIN continuum element in 2D	U, V	Standard
<u>OPN4</u>		PLANE STRAIN continuum element in 2D	U, V	Standard
<u>OPN8</u>		PLANE STRAIN continuum element in 2D	U, V	Standard
<u>OPN4M</u>		PLANE STRAIN continuum element in 2D with enhanced strains	U, V	Standard
<u>OPN4L</u>		PLANE STRAIN continuum element in 2D for large strains	U, V	Standard

Element Reference Manual

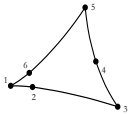
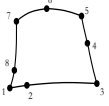
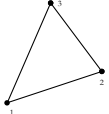
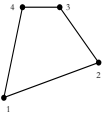
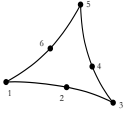
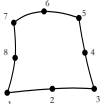
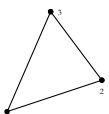
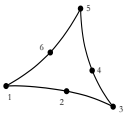
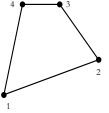
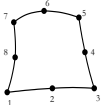
<u>TNK6</u>		PLANE STRAIN continuum crack tip element in 2D	U, V	Standard
<u>QNK8</u>		PLANE STRAIN continuum crack tip element in 2D	U, V	Standard
<u>TPN3E</u>		PLANE STRAIN explicit dynamics element in 2D	U, V	Plus
<u>QPN4E</u>		PLANE STRAIN explicit dynamics element in 2D	U, V	Plus
<u>TPN6P</u>		PLANE STRAIN continuum two phase element in 2D	U, V P: corner nodes U, V: Midside nodes	Standard
<u>QPN8P</u>		PLANE STRAIN continuum two phase element in 2D	U, V P: corner nodes U, V: Midside nodes	Standard
<u>TAX3</u>		AXISYMMETRIC solid continuum element in 2D	U, V	Standard
<u>TAX6</u>		AXISYMMETRIC solid continuum element in 2D	U, V	Standard
<u>QAX4</u>		AXISYMMETRIC solid continuum element in 2D	U, V	Standard
<u>QAX8</u>		AXISYMMETRIC solid continuum element in 2D	U, V	Standard

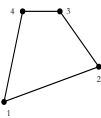
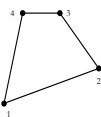
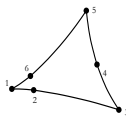
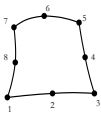
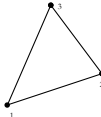
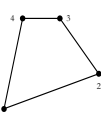
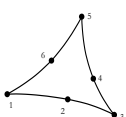
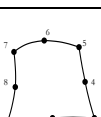
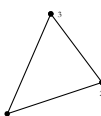
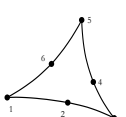
<u>QAX4M</u>		AXISYMMETRIC solid continuum element in 2D with enhanced strains	U, V	Standard
<u>QAX4L</u>		AXISYMMETRIC solid continuum element in 2D for large strains	U, V	Standard
<u>TXK6</u>		AXISYMMETRIC solid continuum crack tip element in 2D	U, V	Standard
<u>QXK8</u>		AXISYMMETRIC solid continuum crack tip element in 2D	U, V	Standard
<u>TAX3E</u>		AXISYMMETRIC solid explicit dynamics element in 2D	U, V	Plus
<u>QAX4E</u>		AXISYMMETRIC solid explicit dynamics element in 2D	U, V	Plus
<u>TAX6P</u>		AXISYMMETRIC solid two phase continuum element in 2D	U, V P: corner nodes U, V: Midside nodes	Plus
<u>QAX8P</u>		AXISYMMETRIC solid two phase continuum element in 2D	U, V P: corner nodes U, V: Midside nodes	Plus
<u>TAX3F</u>		AXISYMMETRIC Fourier ring element in 2D	U, V, W	Plus
<u>TAX6F</u>		AXISYMMETRIC Fourier ring element in 2D	U, V, W	Plus

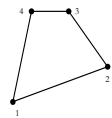
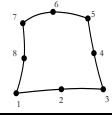
QAX4F		AXISYMMETRIC Fourier ring element in 2D	U, V, W	Plus
QAX8F		AXISYMMETRIC Fourier ring element in 2D	U, V, W	Plus

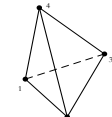
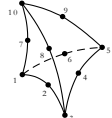
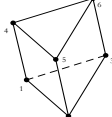
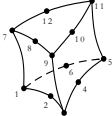
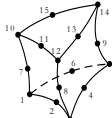
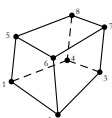
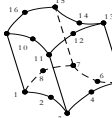
3D Continuum Elements				
Name	Geometry	Title	Freedoms	Product Version
TH4		SOLID CONTINUUM element in 3D	U, V, W	Standard
TH10		SOLID CONTINUUM element in 3D	U, V, W	Plus
PN6		SOLID CONTINUUM element in 3D	U, V, W	Standard
PN12		SOLID CONTINUUM element in 3D	U, V, W	Plus
PN15		SOLID CONTINUUM element in 3D	U, V, W	Plus
HX8		SOLID CONTINUUM element in 3D	U, V, W	Standard
HX16		SOLID CONTINUUM element in 3D	U, V, W	Plus

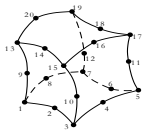
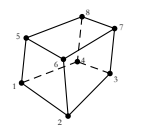
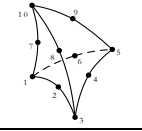
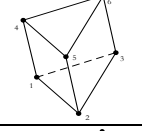
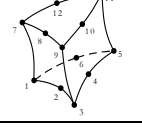
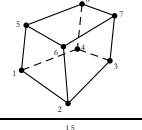
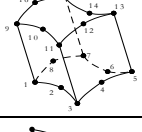
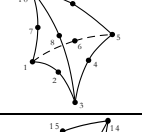
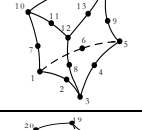
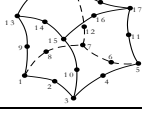
<u>HX20</u>		SOLID CONTINUUM element in 3D	U, V, W	Plus
<u>HX8M</u>		SOLID CONTINUUM element in 3D with enhanced strains	U, V, W	Standard
<u>TH10S</u>		SOLID CONTINUUM composite element in 3D	U, V, W	Plus
<u>PN6L</u>		SOLID CONTINUUM composite element in 3D	U, V, W	Plus
<u>PN12L</u>		SOLID CONTINUUM composite element in 3D	U, V, W	Plus
<u>HX8L</u>		SOLID CONTINUUM composite element in 3D	U, V, W	Plus
<u>HX16L</u>		SOLID CONTINUUM composite element in 3D	U, V, W	Plus
<u>TH10K</u>		SOLID CONTINUUM crack tip element in 3D	U, V, W	Plus
<u>PN15K</u>		SOLID CONTINUUM crack tip element in 3D	U, V, W	Plus
<u>HX20K</u>		SOLID CONTINUUM crack tip element in 3D	U, V, W	Plus



<u>TH4E</u>		SOLID CONTINUUM explicit dynamics element in 3D	U, V, W	Plus
<u>PN6E</u>		SOLID CONTINUUM explicit dynamics element in 3D	U, V, W	Plus
<u>HX8E</u>		SOLID CONTINUUM explicit dynamics element in 3D	U, V, W	Plus
<u>TH10P</u>		SOLID CONTINUUM two phase element in 3D	U, V, W	Plus
<u>PN12P</u>		SOLID CONTINUUM two phase element in 3D	U, V, W	Plus
<u>PN15P</u>		SOLID CONTINUUM two phase element in 3D	U, V, W	Plus
<u>HX16P</u>		SOLID CONTINUUM two phase element in 3D	U, V, W	Plus
<u>HX20P</u>		SOLID CONTINUUM two phase element in 3D	U, V, W	Plus

Plate Elements				
Name	Geometry	Title	Freedom	Product Version
<u>TF3</u>		ISOFLEX thin plate flexure element in 2D	W, qx, qy	Standard

<u>QF4</u>		ISOFLEX thin plate flexure element in 2D	W, qx, qy	Standard
<u>QSC4</u>		ISOFLEX thick plate flexure element in 2D	W, qx, qy	Standard
<u>TTF6</u>		MINDLIN thick plate flexure element in 2D	W, qx, qy	Standard
<u>QTF8</u>		MINDLIN thick plate flexure element in 2D	W, qx, qy	Standard

Shell Elements

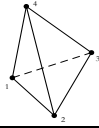
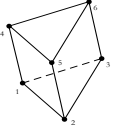
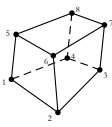
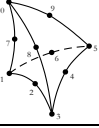
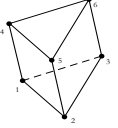
Name	Geometry	Title	Freedom	Product Version
<u>BXS3</u>		AXISYMMETRIC thin shell element in 2D	end nodes: U, V, qz	Standard
<u>BXS12</u>		AXISYMMETRIC thick shell element in 2D	end nodes: U, V, qz	Standard
<u>BXS13</u>		AXISYMMETRIC thick shell element in 2D	end nodes: U, V, qz mid-node: dU	Standard
<u>TS3</u>		FLAT thin shell element in 3D	U, V, W, qx, qy, qz	Standard

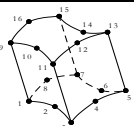
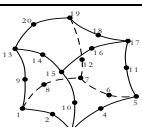
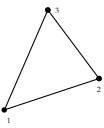
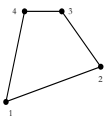
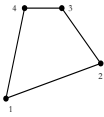
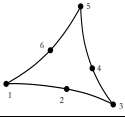
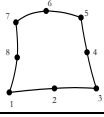
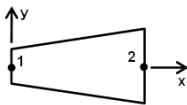
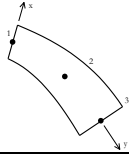
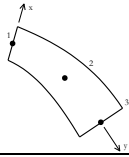
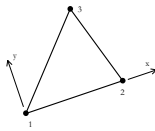
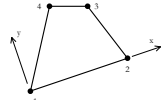
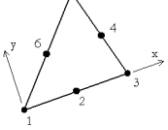
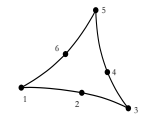
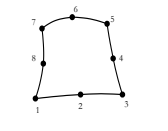
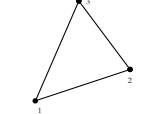
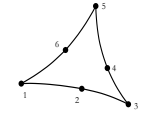
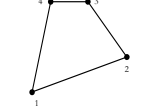
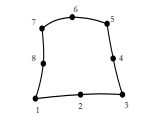

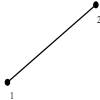
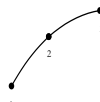
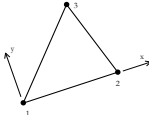
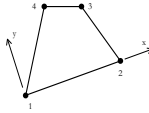

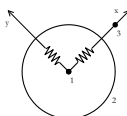
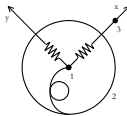
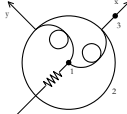
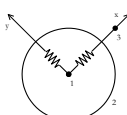





<p><u>QSI4</u></p>		<p>FLAT thin shell element in 3D</p>	<p>U, V, W, qx, qy, qz</p>	<p>Standard</p>
<p><u>TSR6</u></p>		<p>FLAT thin nonlinear shell element in 3D</p>	<p>corner nodes: U, V, W mid-side nodes: q1</p>	<p>Plus</p>
<p><u>TSL6</u></p>		<p>SEMILOOF curved thin shell element in 3D</p>	<p>corner nodes: U, V, W mid-side nodes: U, V, W, q1, q2</p>	<p>Plus</p>
<p><u>QSL8</u></p>		<p>SEMILOOF curved thin shell element in 3D</p>	<p>corner nodes: U, V, W mid-side nodes: U, V, W, q1, q2</p>	<p>Plus</p>
<p><u>TTS3</u></p>		<p>THICK SHELL flat element in 3D</p>	<p>U, V, W, qa, qbor U, V, W, qx, qy, qz</p>	<p>Standard</p>
<p><u>TTS6</u></p>		<p>THICK SHELL curved element in 3D</p>	<p>U, V, W, qa, qbor U, V, W, qx, qy, qz</p>	<p>Plus</p>
<p><u>QTS4</u></p>		<p>THICK SHELL flat element in 3D</p>	<p>U, V, W, qa, qbor U, V, W, qx, qy, qz</p>	<p>Standard</p>
<p><u>QTS8</u></p>		<p>THICK SHELL curved element in 3D</p>	<p>U, V, W, qa, qbor U, V, W, qx, qy, qz</p>	<p>Plus</p>

Membrane Elements				
Name	Geometry	Title	Freedom	Product Version
<u>BXM2</u>		AXISYMMETRIC membrane element in 2D	U, V	Standard
<u>BXM3</u>		AXISYMMETRIC membrane element in 2D	U, V	Standard
<u>TSM3</u>		SPACE membrane element in 3D	U, V, W	Standard
<u>SMI4</u>		SPACE membrane element in 3D	U, V, W	Standard

Joint Elements				
Name	Geometry	Title	Freedom	Product Version
<u>JNT3</u>		JOINT ELEMENT in 2D for bars, plane stress and plane strain	U, V	Standard
<u>JPH3</u>		JOINT ELEMENT in 2D for engineering and Kirchhoff beams	U, V, qz	Standard
<u>JE3</u>		JOINT ELEMENT in 2D for grillage beams and plates	W, qx, qy	Standard
<u>JAX3</u>		JOINT ELEMENT in 2D for axisymmetric solids	U, V	Standard

JXS3		JOINT ELEMENT in 2D for axisymmetric shells	U, V, qz	Standard
JNT4		JOINT ELEMENT in 3D for bars, solids and space membranes	U, V, W	Standard
JL43		JOINT ELEMENT in 3D for corner nodes of semiloof elements	U, V, W	Standard
JSH4 JL46		JOINT ELEMENT in 3D for engineering and Kirchhoff beams and the end/corner nodes of semiloof elements	U, V, W, qx, qy, qz	Standard
JSL4		JOINT ELEMENT in 3D for mid-side nodes of semiloof elements	U, V, W, q1, q2	Plus

Thermal / Field Elements				
Name	Geometry	Title	Freedom	Product Version
BFD2		THERMAL BAR element in 2D	F	Standard
BFD3		THERMAL BAR element in 2D	F	Standard
BFX2		Axisymmetric THERMAL MEMBRANE element in 2D	F	Standard
BFX3		Axisymmetric THERMAL MEMBRANE element in 2D	F	Standard

<u>BFS2</u>		THERMAL BAR element in 3D	F	Standard
<u>BFS3</u>		THERMAL BAR element in 3D	F	Standard
<u>LFD2</u>		THERMAL LINK element in 2D	F	Standard
<u>LFX2</u>		Axisymmetric THERMAL LINK element in 2D	F	Standard
<u>LFS2</u>		THERMAL LINK element in 3D	F	Standard
<u>TFD3</u>		PLANE FIELD element in 2D	F	Standard
<u>TFD6</u>		PLANE FIELD element in 2D	F	Standard
<u>QFD4</u>		PLANE FIELD element in 2D	F	Standard
<u>QFD8</u>		PLANE FIELD element in 2D	F	Standard
<u>TF4</u>		SOLID FIELD element in 3D	F	Standard
<u>TF10</u>		SOLID FIELD element in 3D	F	Plus

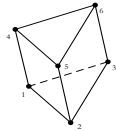
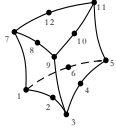
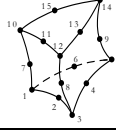
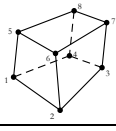
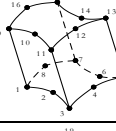
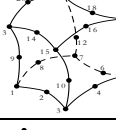
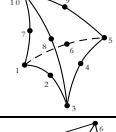
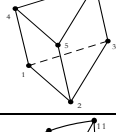
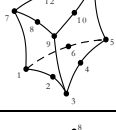
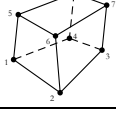
<u>PF6</u>		SOLID FIELD element in 3D	F	Standard
<u>PF12</u>		SOLID FIELD element in 3D	F	Plus
<u>PF15</u>		SOLID FIELD element in 3D	F	Plus
<u>HF8</u>		SOLID FIELD element in 3D	F	Standard
<u>HF16</u>		SOLID FIELD element in 3D	F	Plus
<u>HF20</u>		SOLID FIELD element in 3D	F	Plus
<u>TF10S</u>		SOLID FIELD composite element in 3D	F	Plus
<u>PF6C</u>		SOLID FIELD composite element in 3D	F	Plus
<u>PF12C</u>		SOLID FIELD composite element in 3D	F	Plus
<u>HF8C</u>		SOLID FIELD composite element in 3D	F	Plus

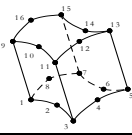
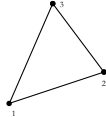
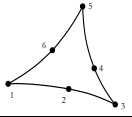
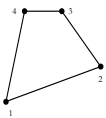
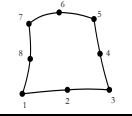
<u>HF16C</u>		SOLID FIELD composite element in 3D	F	Plus
<u>TXF3</u>		AXISYMMETRIC FIELD element in 2D	F	Standard
<u>TXF6</u>		AXISYMMETRIC FIELD element in 2D	F	Standard
<u>QXF4</u>		AXISYMMETRIC FIELD element in 2D	F	Standard
<u>QXF8</u>		AXISYMMETRIC FIELD element in 2D	F	Standard

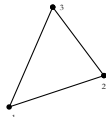
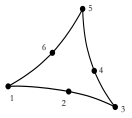
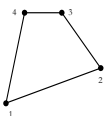
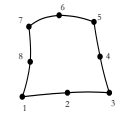
Hygro-Thermal Elements				
Name	Geometry	Title	Freedoms	Product Version
<u>THT3</u>		PLANE HYGRO- THERMAL element in 2D	T, Pc	Plus
<u>THT6</u>		PLANE HYGRO- THERMAL element in 2D	T, Pc	Plus
<u>QHT4</u>		PLANE HYGRO- THERMAL element in 2D	T, Pc	Plus
<u>QHT8</u>		PLANE HYGRO- THERMAL element in 2D	T, Pc	Plus

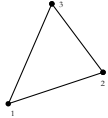
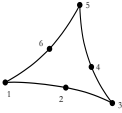
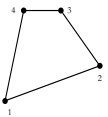
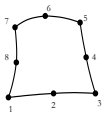
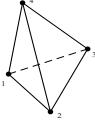
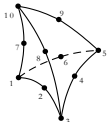
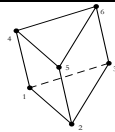
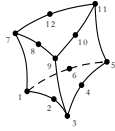
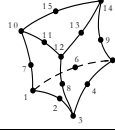
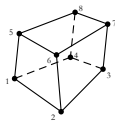

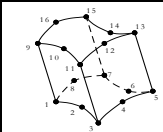
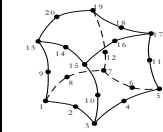
<u>TXHT3</u>		AXISYMMETRIC HYGRO-THERMAL element in 2D	T, Pc	Plus
<u>TXHT6</u>		AXISYMMETRIC HYGRO-THERMAL element in 2D	T, Pc	Plus
<u>QXHT4</u>		AXISYMMETRIC HYGRO-THERMAL element in 2D	T, Pc	Plus
<u>QXHT8</u>		AXISYMMETRIC HYGRO-THERMAL element in 2D	T, Pc	Plus
<u>THT4</u>		SOLID HYGRO- THERMAL element in 3D	T, Pc	Plus
<u>THT10</u>		SOLID HYGRO- THERMAL element in 3D	T, Pc	Plus
<u>PHT6</u>		SOLID HYGRO- THERMAL element in 3D	T, Pc	Plus
<u>PHT12</u>		SOLID HYGRO- THERMAL element in 3D	T, Pc	Plus
<u>PHT15</u>		SOLID HYGRO- THERMAL element in 3D	T, Pc	Plus
<u>HHT8</u>		SOLID HYGRO- THERMAL element in 3D	T, Pc	Plus

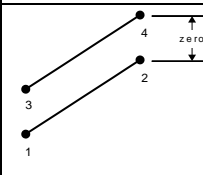
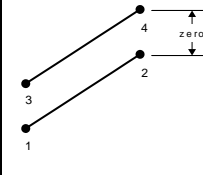
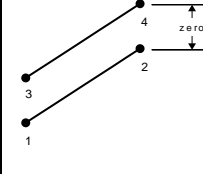
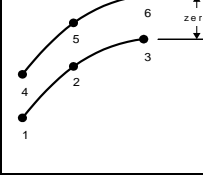
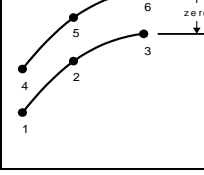
<u>HHT16</u>		SOLID HYGRO-THERMAL element in 3D	T, Pc	Plus
<u>HHT20</u>		SOLID HYGRO-THERMAL element in 3D	T, Pc	Plus

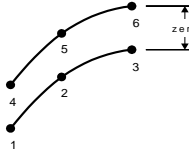
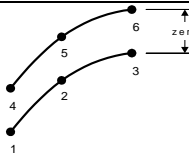
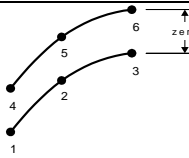
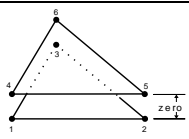
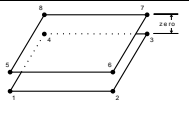
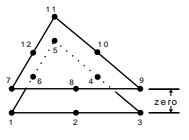
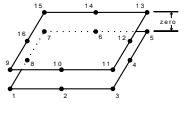
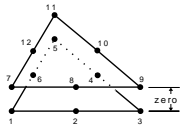
Interface Elements				
Name	Geometry	Title	Freedom	Product Version
<u>IPN4</u>		PLANE STRAIN INTERFACE ELEMENT in 2D (Initial gap allowed for Mohr-Coulomb variant)	U, V	Plus
<u>IPM4</u>		PLANE STRESS INTERFACE ELEMENT in 2D (Initial gap allowed for Mohr-Coulomb variant)	U, V	Plus
<u>IAX4</u>		AXISYMMETRIC INTERFACE ELEMENT in 2D (Initial gap allowed for Mohr-Coulomb variant)	U, V	Plus
<u>IPN6</u>		PLANE STRAIN INTERFACE ELEMENT in 2D (Initial gap allowed for Mohr-Coulomb variant)	U, V, P corner nodes; U,V midside nodes	Plus
<u>IPM6</u>		PLANE STRESS INTERFACE ELEMENT in 2D (Initial gap allowed for Mohr-Coulomb variant)	U, V, P corner nodes; U,V midside nodes	Plus

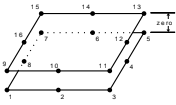
<p><u>IAX6</u></p>		<p>AXISYMMETRIC INTERFACE ELEMENT in 2D (Initial gap allowed for Mohr-Coulomb variant)</p>	<p>U, V</p>	<p>Plus</p>
<p><u>IPN6P</u></p>		<p>PLANE STRAIN TWO PHASE INTERFACE ELEMENT in 2D (Initial gap allowed for Mohr-Coulomb variant)</p>	<p>U, V</p>	<p>Plus</p>
<p><u>IAX6P</u></p>		<p>AXISYMMETRIC TWO PHASE INTERFACE ELEMENT in 2D (Initial gap allowed for Mohr-Coulomb variant)</p>	<p>U, V</p>	<p>Plus</p>
<p><u>IS6</u></p>		<p>INTERFACE ELEMENT in 3D (Initial gap allowed for Mohr-Coulomb variant)</p>	<p>U, V, W</p>	<p>Plus</p>
<p><u>IS8</u></p>		<p>INTERFACE ELEMENT in 3D (Initial gap allowed for Mohr-Coulomb variant)</p>	<p>U, V, W</p>	<p>Plus</p>
<p><u>IS12</u></p>		<p>INTERFACE ELEMENT in 3D (Initial gap allowed for Mohr-Coulomb variant)</p>	<p>U, V, W</p>	<p>Plus</p>
<p><u>IS16</u></p>		<p>INTERFACE ELEMENT in 3D (Initial gap allowed for Mohr-Coulomb variant)</p>	<p>U, V, W</p>	<p>Plus</p>
<p><u>IS12P</u></p>		<p>TWO PHASE INTERFACE ELEMENT in 3D</p>	<p>U, V, W, P corner nodes; U, V, W midside nodes</p>	<p>Plus</p>

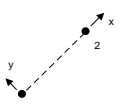
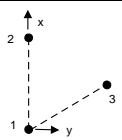
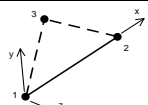
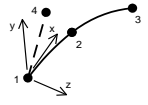
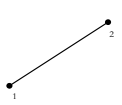
IS16P		TWO PHASE INTERFACE ELEMENT in 3D	U, V, W, P corner nodes; U,V, W midside nodes	Plus
-----------------------	---	-----------------------------------	---	------

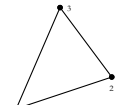
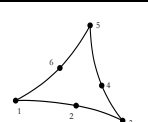
Non-Structural Mass Elements				
Name	Geometry	Title	Freedom	Product Version
PM2		NON-STRUCTURAL MASS ELEMENT in 2D to model mass at a point	U, V	Plus
PM3		NON-STRUCTURAL MASS ELEMENT in 3D to model mass at a point	U, V, W	Plus
LMS3		NON-STRUCTURAL MASS ELEMENT in 3D to model mass along an edge	U, V, W, qx, qy, qz	Plus
LMS4		NON-STRUCTURAL MASS ELEMENT in 3D to model mass along an edge	U, V, W, qx, qy, qz	Plus
LM2		NON-STRUCTURAL MASS ELEMENT in 2D to model mass along an edge	U, V	Plus
LM3		NON-STRUCTURAL MASS ELEMENT in 2D to model mass along an edge	U, V	Plus
TM3		NON-STRUCTURAL MASS ELEMENT in 3D to model mass on a surface.	U,V,W	Plus
TM6		NON-STRUCTURAL MASS ELEMENT in 3D to model mass on a surface.	U,V,W	Plus

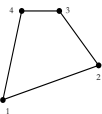
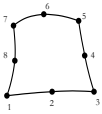
QM4		NON-STRUCTURAL MASS ELEMENT in 3D to model mass on a surface.	U, V, W	Plus
QM8		NON-STRUCTURAL MASS ELEMENT in 3D to model mass on a surface.	U, V, W	Plus

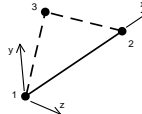
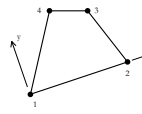
Rigid Slideline Elements				
Name	Geometry	Title	Freedoms	Product Version
R2D2		RIGID SLIDELINE SURFACE ELEMENT in 2D for modelling non-deformable surfaces in a contact analysis	U, V	Plus
R3D3		RIGID SLIDELINE SURFACE ELEMENT in 3D for modelling non-deformable surfaces in a contact analysis	U, V, W	Plus
R3D4		RIGID SLIDELINE SURFACE ELEMENT in 3D for modelling non-deformable surfaces in a contact analysis	U, V, W	Plus

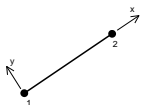
Phreatic Elements				
Name	Geometry	Title	Freedoms	Product Version
PHS2		PHREATIC SURFACE ELEMENT in 2D for modelling phreatic surface.	U, V	Plus

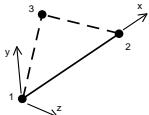
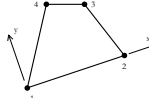
PHS3		PHREATIC SURFACE ELEMENT in 3D for modelling phreatic surface.	U, V, W	Plus
PHS4		PHREATIC SURFACE ELEMENT in 3D for modelling phreatic surface.	U, V, W	Plus

Element Summary Tables

The following element summary tables list element facilities arranged by LUSAS element group:

- [Bar and Beam elements](#)
- [2D Continuum elements](#)
- [3D Continuum elements](#)
- [Plate, Shell and Membrane elements](#)
- [Joint elements](#)
- [Thermal/Field elements](#)
- [Hygro-Thermal elements](#)
- [Interface, Non-Structural Mass, Rigid, Interface and Phreatic elements](#)

Bar and Beam Element Summary		Bars		Beams																	
		BAR2, BAR3	BRS2, BRS3	GRIL	BMI21	BMI2, BMI3	BMI2N, BMI3N	BMI2X, BMI3X	BMI22, BMI31, BMI33	BMI21W, BMI22W, BMI31W, BMI33W	BMX21, BMX22, BMX31, BMX32	BMX21W, BMX22W, BMX31W, BMX33W	BM3	BMX3	BS3, BS4	BSX4	BSL3, BSL4	BXL4			
Product version	LT, Standard (S) or Plus (+)	L	T	L	T	L	T	L	T	S	+	+	+	+	+	S	S	+	+	+	+
Nodal freedoms	U, V	✓																			
	U, V, W		✓																		
(mid-side)	U, V, qz					✓	✓	✓													
	U, V, qz (dU)													✓	✓						
	W, qx, qy			✓																	
	U, V, W, qx, qy, qz (dU, dqx)																✓	✓			
	U, V, W, qx, qy, qz (U, V, W, q1, q2)																		✓	✓	
	U, V, W, qx, qy																				
	U, V, W, qx, qy, qz				✓				✓		✓	✓									
Material properties	Linear (Isotropic)	✓	✓	✓	✓	✓	✓	✓	✓	✓	✓	✓	✓	✓	✓	✓	✓	✓	✓	✓	✓
	Linear (Orthotropic)																				
	Linear (Anisotropic)																				
	Linear (Rigidities)				✓	✓			✓	✓			✓		✓		✓	✓	✓		
	Matrix																				
	Joint																				
	Concrete Multi-crack							✓		✓	✓										
	Stress Resultant				✓	✓			✓	✓				✓		✓		✓		✓	
	Tresca	✓	✓				✓	✓				✓	✓		✓		✓		✓		✓
	Drucker-Prager	✓	✓				✓	✓				✓	✓		✓		✓		✓		✓
	Mohr-Coulomb	✓	✓				✓	✓				✓	✓		✓		✓		✓		✓
	Optimised Implicit Von Mises	✓	✓				✓	✓				✓	✓		✓		✓		✓		✓
	Volumetric Crushing/Foam																				
	Stress Potential(Von	✓	✓				✓	✓				✓	✓		✓		✓		✓		✓

		Bars		Beams																		
Bar and Beam Element Summary																						
		BAR2, BAR3	BRS2, BRS3	GRIL	BMI21	BMI2, BMI3	BMI2N, BMI3N	BMI2X, BMI3X	BMI22, BMI31, BMI33	BMI21W, BMI22W, BMI31W, BMI33W	BMX21, BMX22, BMX31, BMX32	BMX21W, BMX22W, BMX31W, BMX33W	BM3	BMX3	BS3, BS4	BSX4	BSL3, BSL4	BXL4				
Product version	LT, Standard (S) or Plus (+)	L	T	L	T	L	T	L	T	S	+	+	+	+	+	S	S	+	+	+	+	
	Mises, Modified Von Mises)																					
	Creep (General)	✓	✓						✓	✓				✓	✓	✓	✓	✓	✓	✓	✓	✓
	Creep (AASHTO)				✓	✓	✓	✓	✓			✓	✓	✓	✓	✓	✓	✓	✓	✓	✓	✓
	Creep (CEB-FIP)				✓	✓	✓	✓	✓			✓	✓	✓	✓	✓	✓	✓	✓	✓	✓	✓
	Creep (Chinese)				✓	✓	✓	✓	✓			✓	✓	✓	✓	✓	✓	✓	✓	✓	✓	✓
	Creep (Eurocode)				✓	✓	✓	✓	✓			✓	✓	✓	✓	✓	✓	✓	✓	✓	✓	✓
	Creep (IRC)				✓	✓	✓	✓	✓			✓	✓	✓	✓	✓	✓	✓	✓	✓	✓	✓
	Damage (Simo, Oliver)	✓	✓					✓	✓					✓	✓		✓		✓		✓	✓
	Viscoelastic	✓																				
	Shrinkage (CEB-FIP_90, Eurocode_2, General, User)	✓			✓	✓	✓	✓	✓			✓	✓	✓	✓	✓	✓	✓	✓	✓	✓	✓
	Rubber																					
	Generic Polymer																					
	Multi-linear	✓	✓																			
	Composite																					
	Field																					
Loading types	Prescribed Value (PDSP,TPDSP)	✓	✓	✓	✓	✓	✓	✓	✓	✓	✓	✓	✓	✓	✓	✓	✓	✓	✓	✓	✓	✓
	Concentrated Loads (CL)	✓	✓	✓	✓	✓	✓	✓	✓	✓	✓	✓	✓	✓	✓	✓	✓	✓	✓	✓	✓	✓
	Element Load (ELDS)			✓	✓	✓	✓	✓	✓	✓	✓	✓	✓	✓	✓	✓	✓					✓
	Distributed Load (UDL)			✓	✓	✓	✓	✓	✓	✓	✓	✓	✓	✓	✓	✓	✓	✓	✓	✓	✓	✓
	Distributed Load (FLD)																					

		Bars		Beams														
Bar and Beam Element Summary		BAR2, BAR3	BRS2, BRS3	GRIL	BMI21	BMI2, BMI3	BMI2N, BMI3N	BMI2X, BMI3X	BMI22, BMI31, BMI33	BMI21W, BMI22W, BMI31W, BMI33W	BMX21, BMX22, BMX31, BMX32	BMX21W, BMX22W, BMX31W, BMX33W	BM3	BMX3	BS3, BS4	BSX4	BSL3, BSL4	BXL4
Product version	LT, Standard (S) or Plus (+)	LT	LT	LT	LT	LT	S	+	+	+	+	+	S	S	+	+	+	+
	Body Force (CBF)	✓	✓	✓	✓	✓	✓	✓	✓	✓	✓	✓	✓	✓	✓	✓	✓	✓
	Body Force (BFP,BFPE)	✓	✓	✓	✓	✓	✓	✓	✓	✓	✓	✓	✓	✓	✓	✓	✓	✓
	Velocity (VELO)	✓	✓	✓	✓	✓	✓	✓	✓	✓	✓	✓	✓	✓	✓	✓	✓	✓
	Acceleration (ACCE)	✓	✓	✓	✓	✓	✓	✓	✓	✓	✓	✓	✓	✓	✓	✓	✓	✓
	Initial Stress/Strain (SSI,SSIE)	✓	✓		✓	✓	✓	✓	✓	✓	✓	✓	✓	✓	✓	✓	✓	✓
	Initial Stress/Strain (SSIG)	✓	✓		✓	✓	✓	✓	✓	✓	✓	✓	✓	✓	✓	✓	✓	✓
	Residual Stress (SSR,SSRE)				✓	✓	✓	✓	✓	✓	✓	✓	✓	✓	✓	✓	✓	✓
	Residual Stress (SSRG)	✓	✓		✓	✓	✓	✓	✓	✓	✓	✓	✓	✓	✓	✓	✓	✓
	Target Stress/Strain (TSSIE,TSSIA)	✓	✓		✓	✓	✓	✓	✓	✓	✓	✓	✓	✓	✓	✓	✓	✓
	Target Stress/Strain (TSSIG)	✓	✓		✓	✓	✓	✓	✓	✓	✓	✓	✓	✓	✓	✓	✓	✓
	Temperature (TEMP,TMPE)	✓	✓	✓	✓	✓	✓	✓	✓	✓	✓	✓	✓	✓	✓	✓	✓	✓
	Field Loads																	
	Temperature Dependent Loads																	
Nonlinear geometry	Total Lagrangian	✓	✓	✓	✓	✓	✓	✓	✓	✓	✓	✓	✓	✓	✓	✓	✓	✓
	Updated Lagrangian							✓					✓	✓	✓	✓		
	Eulerian																	
	Co-rotational	✓	✓	✓	✓	✓			✓	✓	✓	✓						
Integration schemes	Explicitly Integrated			✓														
	Numerically	✓	✓		✓	✓	✓	✓	✓	✓	✓	✓	✓	✓	✓	✓	✓	✓

		Bars		Beams															
Bar and Beam Element Summary		<u>BAR2, BAR3</u>	<u>BRS2, BRS3</u>	<u>GRIL</u>	<u>BMI21</u>	<u>BMI2, BMI3</u>	<u>BMI2N, BMI3N</u>	<u>BMI2X, BMI3X</u>	<u>BMI22, BMI31, BMI33</u>	<u>BMI21W, BMI22W, BMI31W, BMI33W</u>	<u>BMX21, BMX22, BMX31, BMX32</u>	<u>BMX21W, BMX22W, BMX31W, BMX33W</u>	<u>BM3</u>	<u>BMX3</u>	<u>BS3, BS4</u>	<u>BSX4</u>	<u>BSL3, BSL4</u>	<u>BXL4</u>	
Product version	LT, Standard (S) or Plus (+)	L	L	L	L	L	S	+	+	+	+	+	S	S	+	+	+	+	
	Integrated																		
Mass modelling	Consistent Mass (default)	✓	✓	✓	✓	✓	✓	✓	✓	✓	✓	✓	✓	✓	✓	✓	✓	✓	✓
	Lumped Mass	✓	✓	✓	✓	✓	✓	✓	✓	✓	✓	✓	✓	✓	✓	✓	✓	✓	✓

2D Continuum Element Summary		2D Continuum																
		TPM3/6, QPM4/8	QPM4M	TPK6, QPK8	TPM3E, QPM4E	TPN3/6, QPN4/8	QPN4M	QPN4L	TNK6, QNK8	TPN3E, QPN4E	TPN6P, QPN8P	TAX3/6, QAX4/8	QAX4M	QAX4L	TXK6, QXK8	TAX3E, QAX4E	TAX6P, QAX8P	TAX3F/6F, QAX4F/8F
Product Version	LT, Standard (S) or Plus (+)	S	S	S	+	S	S	S	S	+	+	S	S	S	S	+	+	+
Nodal freedoms	U, V	✓	✓	✓	✓	✓	✓	✓	✓	✓		✓	✓	✓	✓			
	U, V, W																	✓
(corner)	U, V, (P)										✓						✓	
Material properties	Linear (Isotropic)	✓	✓	✓	✓	✓	✓		✓	✓	✓	✓	✓		✓	✓	✓	✓
	Linear (Orthotropic)	✓	✓	✓	✓	✓	✓		✓	✓	✓	✓	✓		✓	✓	✓	✓
	Linear (Anisotropic)	✓	✓	✓		✓	✓*		✓*		✓*	✓	✓*		✓*		✓*	
	Linear (Rigidities)	✓	✓	✓		✓	✓*		✓*		✓*						✓*	
	Matrix																	
	Joint																	
	Concrete Multi-crack	✓	✓	✓		✓	✓		✓		✓	✓	✓		✓		✓	
	Concrete Multi-crack(Transient)	✓	✓	✓		✓	✓				✓	✓						
	Stress Resultant																	
	Tresca	✓	✓	✓	✓	✓	✓		✓	✓	✓	✓	✓		✓	✓	✓	
	Optimised Implicit Von Mises	✓	✓	✓	✓	✓	✓		✓	✓	✓	✓	✓		✓	✓	✓	
	Mohr-Coulomb	✓	✓	✓	✓	✓	✓		✓	✓	✓	✓	✓		✓	✓	✓	
	Modified Mohr-Coulomb					✓	✓		✓	✓	✓	✓	✓		✓	✓	✓	
	Drucker-Prager	✓	✓	✓	✓	✓	✓		✓	✓	✓	✓	✓		✓	✓	✓	
	Modified Cam-clay					✓	✓		✓		✓	✓	✓		✓		✓	

2D Continuum Element Summary		2D Continuum																
		TPM3/6, QPM4/8	QPM4M	TPK6, QPK8	TPM3E, QPM4E	TPN3/6, OPN4/8	OPN4M	OPN4L	TNK6, QNK8	TPN3E, OPN4E	TPN6P, OPN8P	TAX3/6, QAX4/8	QAX4M	QAX4L	TXK6, QXK8	TAX3E, QAX4E	TAX6P, QAX8P	TAX3F/6F, QAX4F/8F
Product Version	LT, Standard (S) or Plus (+)	S	S	S	+	S	S	S	S	+	+	S	S	S	S	+	+	+
	Volumetric Crushing/Foam					✓	✓		✓	✓	✓	✓	✓		✓	✓	✓	
	Stress Potential (Von Mises, Modified Von Mises)	✓	✓	✓	✓	✓	✓		✓	✓	✓	✓	✓		✓	✓	✓	
	Interface (2D)	✓																
	Creep (General)	✓	✓	✓		✓	✓		✓	✓	✓	✓	✓		✓	✓	✓	
	Creep (AASHTO)	✓	✓	✓		✓	✓		✓			✓	✓		✓			
	Creep (CEB-FIP)	✓	✓	✓		✓	✓		✓			✓	✓		✓			
	Creep (Chinese)	✓	✓	✓		✓	✓		✓			✓	✓		✓			
	Creep (Eurocode)	✓	✓	✓		✓	✓		✓			✓	✓		✓			
	Creep (IRC)	✓	✓	✓		✓	✓		✓			✓	✓		✓			
	Damage (Simo, Oliver)	✓	✓	✓		✓	✓		✓	✓	✓	✓	✓		✓	✓	✓	
	Viscoelastic					✓	✓			✓	✓	✓	✓		✓	✓	✓	
	Shrinkage (CEB-FIP, Eurocode, General, User)	✓		✓		✓	✓		✓		✓	✓	✓	✓	✓		✓	
	Ko Initialisation					✓	✓		✓			✓	✓		✓	✓	✓	
	Rubber (Ogden, Mooney-Rivlen, Neo-Hookean, Hencky)		✓				✓	✓						✓				
	Generic Polymer		✓	✓		✓	✓		✓		✓	✓	✓		✓		✓	
	Composite																	
	Field																	
Loading	Prescribed Value	✓	✓	✓	✓	✓	✓	✓	✓	✓	✓	✓	✓	✓	✓	✓	✓	✓

2D Continuum Element Summary		2D Continuum																
		TPM3/6, OPM4/8	OPM4M	TPK6, OPK8	TPM3E, OPM4E	TPN3/6, QPN4/8	QPN4M	QPN4L	TNK6, QNK8	TPN3E, QPN4E	TPN6P, QPN8P	TAX3/6, QAX4/8	QAX4M	QAX4L	TXK6, QXK8	TAX3E, QAX4E	TAX6P, QAX8P	TAX3F/6F, QAX4F/8F
Product Version	LT, Standard (S) or Plus (+)	S	S	S	+	S	S	S	S	+	+	S	S	S	S	+	+	+
types	(PDSP,TPDSP)																	
	Concentrated Loads (CL)	✓	✓	✓	✓	✓	✓	✓	✓	✓	✓	✓	✓	✓	✓	✓	✓	✓
	Element Load																	
	Distributed Load (UDL)																	
	Distributed Load (FLD)	✓	✓	✓	✓	✓	✓	✓	✓	✓	✓	✓	✓	✓	✓	✓	✓	✓
	Body Force (CBF,BFP,BFPE)	✓	✓	✓	✓	✓	✓	✓	✓	✓	✓	✓	✓	✓	✓	✓	✓	✓
	Velocity (VELO)	✓	✓	✓	✓	✓	✓	✓	✓	✓	✓	✓	✓	✓	✓	✓	✓	✓
	Acceleration (ACCE)	✓	✓	✓	✓	✓	✓	✓	✓	✓	✓	✓	✓	✓	✓	✓	✓	✓
	Viscous Support Load (VSL)	✓	✓	✓	✓	✓	✓	✓	✓	✓	✓	✓	✓	✓	✓	✓	✓	
	Initial Stress/Strain (SSI,SSIE)	✓	✓	✓	✓	✓	✓	✓	✓	✓	✓	✓	✓	✓	✓	✓	✓	✓
	Initial Stress/Strain (SSIG)	✓	✓	✓	✓	✓	✓	✓	✓	✓	✓	✓	✓	✓		✓	✓	✓
	Residual Stress (SSR)	✓	✓	✓	✓	✓	✓	✓	✓	✓	✓	✓	✓	✓	✓	✓	✓	
	Residual Stress (SSRE,SSRG)	✓	✓	✓	✓	✓	✓	✓	✓	✓	✓	✓	✓	✓	✓	✓	✓	
	Target Stress/Strain (TSSIE,TSSIA)	✓	✓	✓	✓	✓	✓	✓	✓	✓	✓	✓	✓	✓	✓	✓	✓	✓
	Target	✓	✓	✓	✓	✓	✓	✓	✓	✓	✓	✓	✓	✓		✓	✓	✓

2D Continuum Element Summary		2D Continuum																	
		TPM3/6, QPM4/8	QPM4M	TPK6, QPK8	TPM3E, QPM4E	TPN3/6, OPN4/8	OPN4M	OPN4L	TNK6, QNK8	TPN3E, OPN4E	TPN6P, OPN8P	TAX3/6, QAX4/8	QAX4M	QAX4L	TXK6, QXK8	TAX3E, QAX4E	TAX6P, QAX8P	TAX3E/6E, QAX4E/8E	
Product Version	LT, Standard (S) or Plus (+)	S	S	S	+	S	S	S	S	+	+	S	S	S	S	+	+	+	
	Stress/Strain (TSSIG)																		
	Temperature (TEMP, TMPE)	✓	✓	✓	✓	✓	✓	✓	✓	✓	✓	✓	✓	✓	✓	✓	✓	✓	✓
	Field Load																		
	Temp Dependent Load																		
	Overburden	✓	✓	✓		✓	✓	✓	✓		✓	✓	✓	✓	✓		✓		
	Phreatic Surface	✓	✓	✓		✓	✓	✓			✓	✓	✓	✓	✓		✓		
Nonlinear geometry	Total Lagrangian	✓	✓	✓		✓	✓		✓		✓	✓	✓		✓		✓		
	Updated Lagrangian	✓	✓	✓		✓	✓		✓		✓	✓	✓		✓		✓		
	Eulerian	✓	✓	✓	✓	✓	✓	✓	✓	✓	✓	✓	✓	✓	✓	✓	✓	✓	
	Co-rotational	✓	✓	✓		✓	✓		✓		✓								
Integration schemes	Explicitly Integrated																		
	Numerically Integrated	✓	✓	✓	✓	✓	✓	✓	✓	✓	✓	✓	✓	✓	✓	✓	✓	✓	✓
Mass modelling	Consistent Mass (default)	✓	✓	✓		✓	✓	✓	✓		✓	✓	✓	✓	✓		✓	✓	
	Lumped Mass	✓	✓	✓	✓	✓	✓	✓	✓	✓	✓	✓	✓	✓	✓	✓	✓	✓	✓

* Linear anisotropic and rigidities material properties for elements marked are supported in LUSAS Solver but not supported in LUSAS Modeller.

		3D Continuum													
		TH4	TH10	PN6	PN12/15	HX8	HX16/20	HX8M	TH10K, PN15K, HX20K	TH10S	PN6L, PN12L	HX8L, HX16L	TH4E, PN6E, HX8E	TH10P, PN12P, PN15P, HX16P, HX20P	
3D Continuum Element Summary															
Product Version	LT, Standard (S) or Plus (+)	S	+	S	+	S	+	S	+	+	+	+	+	+	
Nodal freedoms	U, V														
	U, V, W	✓	✓	✓	✓	✓	✓	✓	✓	✓	✓	✓	✓		
(corner)	U, V, W (P)													✓	
Material properties	Linear (Isotropic)	✓	✓	✓	✓	✓	✓	✓	✓	✓	✓	✓	✓	✓	
	Linear (Orthotropic)	✓	✓	✓	✓	✓	✓	✓	✓	✓	✓	✓	✓	✓	
	Linear (Anisotropic)	✓	✓	✓	✓	✓	✓	✓	✓	✓	✓			✓	
	Linear (Rigidities)														
	Matrix														
	Joint														
	Concrete (Multi-crack)	✓	✓	✓	✓	✓	✓	✓	✓	✓	✓			✓	
	Concrete (Multi-crack)Transient	✓	✓	✓	✓	✓	✓	✓							
	Stress Resultant														
	Tresca	✓	✓	✓	✓	✓	✓	✓	✓	✓	✓	✓	✓	✓	
	Optimised Implicit Von Mises	✓	✓	✓	✓	✓	✓	✓	✓	✓	✓	✓	✓	✓	
	Mohr-Coulomb	✓	✓	✓	✓	✓	✓	✓	✓	✓	✓	✓	✓	✓	
	Modified Mohr-Coulomb	✓	✓	✓	✓	✓	✓	✓	✓					✓	
	Drucker-Prager	✓	✓	✓	✓	✓	✓	✓	✓	✓	✓	✓	✓	✓	
	Modified Cam-clay	✓	✓	✓	✓	✓	✓	✓	✓					✓	

3D Continuum Element Summary		3D Continuum												
		TH4	TH10	PN6	PN12/15	HX8	HX16/20	HX8M	TH10K, PN15K, HX20K	TH10S	PN6L, PN12L	HX8L, HX16L	TH4E, PN6E, HX8E	TH10P, PN12P, PN15P, HX16P, HX20P
Product Version	LT, Standard (S) or Plus (+)	S	+	S	+	S	+	S	+	+	+	+	+	+
	Volumetric Crushing/Foam	✓	✓	✓	✓	✓	✓		✓	✓	✓	✓	✓	✓
	Stress Potential(Von Mises, Modified Von Mises Hill, Hoffman)	✓	✓	✓	✓	✓	✓	✓	✓	✓	✓	✓	✓	✓
	Creep (General)	✓	✓	✓	✓	✓	✓		✓				✓	✓
	Creep (AASHTO)	✓	✓	✓	✓	✓	✓	✓	✓	✓	✓			
	Creep (CEB-FIP)	✓	✓	✓	✓	✓	✓	✓	✓	✓	✓			
	Creep (Chinese)	✓	✓	✓	✓	✓	✓	✓	✓	✓	✓			
	Creep (Eurocode)	✓	✓	✓	✓	✓	✓	✓	✓	✓	✓			
	Creep (IRC)	✓	✓	✓	✓	✓	✓	✓	✓	✓	✓			
	Damage	✓	✓	✓	✓	✓	✓	✓	✓	✓	✓	✓	✓	✓
	Viscoelastic	✓	✓	✓	✓	✓	✓	✓	✓	✓	✓			✓
	Shrinkage (CEB-FIP, Eurocode, General, User)	✓	✓	✓	✓	✓	✓	✓	✓	✓	✓			✓
	Ko Initialisation	✓	✓	✓	✓	✓	✓	✓	✓					✓
	Elasto-plastic interface	✓	✓	✓	✓	✓	✓		✓					✓
	Rubber (Ogden, Mooney-Rivlin, Neo- Hookean, Hencky)							✓						
	Generic Polymer	✓	✓	✓	✓	✓	✓	✓	✓	✓	✓			✓
	Resin Cure Model								•	✓	✓	✓		
	Composite								•	✓	✓	✓		

3D Continuum Element Summary		3D Continuum													
		TH4	TH10	PN6	PN12/15	HX8	HX16/20	HX8M	TH10K, PN15K, HX20K	TH10S	PN6L, PN12L	HX8L, HX16L	TH4E, PN6E, HX8E	TH10P, PN12P, PN15P, HX16P, HX20P	
Product Version	LT, Standard (S) or Plus (+)	S	+	S	+	S	+	S	+	S	+	+	+	+	
	(Composite Solid)														
	Composite (Composite Shell)														
	Field														
Loading types	Prescribed Value (PDSP,TPDSP)	✓	✓	✓	✓	✓	✓	✓	✓	✓	✓	✓	✓	✓	
	Concentrated Loads (CL)	✓	✓	✓	✓	✓	✓	✓	✓	✓	✓	✓	✓	✓	
	Element Loads														
	Distributed Load (UDL)														
	Distributed Load (FLD)	✓	✓	✓	✓	✓	✓	✓	✓	✓	✓	✓	✓	✓	
	Body Force (CBF,BFP,BFPE)	✓	✓	✓	✓	✓	✓	✓	✓	✓	✓	✓	✓	✓	
	Velocity (VELO)	✓	✓	✓	✓	✓	✓	✓	✓	✓	✓	✓	✓	✓	
	Acceleration (ACCE)	✓	✓	✓	✓	✓	✓	✓	✓	✓	✓	✓	✓	✓	
	Viscous Support Load (VSL)	✓	✓	✓	✓	✓	✓	✓	✓	✓	✓	✓	✓	✓	
	Initial Stress/Strain (SSL,SSIE)	✓	✓	✓	✓	✓	✓	✓	✓	✓	✓	✓	✓	✓	
	Initial Stress/Strain (SSIG)	✓	✓	✓	✓	✓	✓	✓	✓	✓	✓	✓	✓	✓	
	Residual Stress (SSR,SSRE)	✓	✓	✓	✓	✓	✓	✓	✓	✓	✓	✓	✓	✓	
	Residual Stress (SSRG)	✓	✓	✓	✓	✓	✓	✓	✓	✓	✓	✓	✓	✓	
	Target	✓	✓	✓	✓	✓	✓	✓	✓	✓	✓	✓	✓	✓	

		3D Continuum												
		TH4	TH10	PN6	PN12/15	HX8	HX16/20	HX8M	TH10K, PN15K, HX20K	TH10S	PN6L, PN12L	HX8L, HX16L	TH4E, PN6E, HX8E	TH10P, PN12P, PN15P, HX16P, HX20P
3D Continuum Element Summary														
Product Version	LT, Standard (S) or Plus (+)	S	+	S	+	S	+	S	+	+	+	+	+	+
	Stress/Strain (TSSIE, TSSIA)													
	Target Stress/Strain (TSSIG)	✓	✓	✓	✓	✓	✓	✓	✓	✓	✓	✓	-	✓
	Temperature (TEMP, TMPE)	✓	✓	✓	✓	✓	✓	✓	✓	✓	✓	✓	✓	✓
	Field Load													
	Temp Dependent Load													
	Overburden	✓	✓	✓	✓	✓	✓	✓	✓	✓	✓	✓		✓
	Phreatic Surface	✓	✓	✓	✓	✓	✓	✓	✓	✓	✓	✓		✓
Nonlinear geometry	Total Lagrangian	✓	✓	✓	✓	✓	✓	✓	✓					✓
	Updated Lagrangian	✓	✓	✓	✓	✓	✓	✓	✓					✓
	Eulerian	✓	✓	✓	✓	✓	✓	✓	✓				✓	✓
	Co-rotational	✓	✓	✓	✓	✓	✓	✓	✓	✓	✓	✓		✓
Integration schemes	Explicitly Integrated													
	Numerically Integrated	✓	✓	✓	✓	✓	✓	✓	✓	✓	✓	✓	✓	✓
Mass modelling	Consistent Mass (default)	✓	✓	✓	✓	✓	✓	✓	✓	✓	✓	✓		✓
	Lumped Mass	✓	✓	✓	✓	✓	✓	✓	✓	✓	✓	✓	✓	✓

Plate, Shell and Membrane Element Summary		Plates			Shells								Membranes		
		TF3, QF4	QSC4	TTF6, QTF8	BXS3	BXS12, BXS13	TS3, OSI4	TSR6	TSL6, QSL8	TTS3	TTS6	QTS4	QTS8	BXM2/3	TSM3, SMI4
Product Version	LT, Standard (S) or Plus (+)	S	S	S	S	S	S	+	+	S	+	S	+	S	S
Nodal	U, V													✓	
Freedoms (mid-side)	U, V, W														✓
	W, qx, qy		✓	✓											
	W, qx, qy (dq)	✓													
	U, V, W, qx, qy														
	U, V, qz					✓									
	U, V, qz (dU)				✓										
	U, V, W, qx, qy, qz						✓								
	U, V, W (U, V, W, q1, q2)							✓							
	U, V, W (q1,)						✓								
	U, V, W, qa, qb (U, V, W, qx, qy, qz)								✓	✓	✓	✓			
Material properties	Linear (Isotropic)	✓	✓	✓	✓	✓	✓	✓	✓	✓	✓	✓	✓	✓	✓
	Linear (Orthotropic)	✓	✓	✓	✓		✓	✓	✓	✓	✓	✓			✓
	Linear (Anisotropic)	✓	✓	✓	✓		✓	✓	✓	✓	✓	✓			✓
	Linear (Rigidities)	✓	✓	✓			✓	✓	✓						✓
	Matrix														
	Joint														
	Concrete (Multi-crack)							✓	✓	✓	✓	✓	✓		
	Stress Resultant				✓			✓	✓						
	Tresca				✓	✓		✓	✓	✓	✓	✓	✓	✓	
	Optimised Implicit Von Mises				✓	✓		✓	✓	✓	✓	✓	✓	✓	
	Mohr-Coulomb				✓	✓		✓	✓	✓	✓	✓	✓	✓	
	Drucker-Prager				✓	✓		✓	✓	✓	✓	✓	✓	✓	
	Volumetric Crushing/Foam														
	Stress Potential (Von-Mises, Modified Von				✓	✓		✓	✓	✓	✓	✓	✓	✓	

Plate, Shell and Membrane Element Summary		Plates			Shells								Membranes		
		TF3, QF4	QSC4	TTF6, OTF8	BXS3	BXS12, BXS13	TS3, OSI4	TSR6	TSL6, OSI8	TTS3	TTS6	QTS4	QTS8	BXM2/3	TSM3, SMI4
Product Version	LT, Standard (S) or Plus (+)	S	S	S	S	S	S	+	+	S	+	S	+	S	S
	Mises)														
	Stress Potential(Hill, Hoffman)				✓	✓		✓	✓	✓	✓	✓	✓		
	Creep (General)				✓	✓		✓	✓	✓	✓	✓	✓	✓	
	Creep (AASHTO)				✓	✓			✓	✓	✓	✓	✓		
	Creep (CEB_FIP_90)				✓	✓			✓	✓	✓	✓	✓		
	Creep (Chinese)				✓	✓			✓	✓	✓	✓	✓		
	Creep (Eurocode)				✓	✓			✓	✓	✓	✓	✓		
	Creep (IRC)				✓	✓			✓	✓	✓	✓	✓		
	Damage				✓	✓		✓	✓	✓	✓	✓	✓	✓	
	Viscoelastic														
	Shrinkage (CEB-FIP_90, Eurocode_2, General, User)				✓	✓	✓	✓	✓	✓	✓	✓	✓	✓	✓
	Ko Initialisation														
	Rubber (Ogden, Mooney-Rivlin, Neo-Hookean, Hencky)													✓	
	Generic Polymer														
	Composite (Composite Shell)								✓	✓	✓	✓	✓		
	Field														
Loading types	Prescribed Value (PDSP,TPDSP)	✓	✓	✓	✓	✓	✓	✓	✓	✓	✓	✓	✓	✓	✓
	Concentrated Loads (CL)	✓	✓	✓	✓	✓	✓	✓	✓	✓	✓	✓	✓	✓	✓
	Element Load (ELDS)				✓	✓									
	Distributed Load (UDL)	✓	✓	✓	✓	✓	✓	✓	✓	✓	✓	✓	✓	✓	✓
	Distributed Load (FLD)				✓	✓								✓	
	Body Force (CBF,BFP,BFPE)	✓	✓	✓	✓	✓	✓	✓	✓	✓	✓	✓	✓	✓	✓

Plate, Shell and Membrane Element Summary		Plates			Shells								Membranes		
		TF3, QF4	QSC4	TTF6, QTF8	BXS3	BXS12, BXS13	TS3, OSI4	TSR6	TSL6, QSL8	TTS3	TTS6	QTS4	QTS8	BXM2/3	TSM3, SMI4
Product Version	LT, Standard (S) or Plus (+)	S	S	S	S	S	S	+	+	S	+	S	+	S	S
	Velocity (VELO)	✓	✓	✓	✓	✓	✓	✓	✓	✓	✓	✓	✓	✓	✓
	Acceleration (ACCE)	✓	✓	✓	✓	✓	✓	✓	✓	✓	✓	✓	✓	✓	✓
	Viscous Support Load (VSL)	✓	✓	✓	✓	✓	✓	✓	✓	✓	✓	✓	✓	✓	✓
	Initial Stress/Strain (SSI,SSIE)	✓	✓	✓	✓	✓	✓							✓	✓
	Initial Stress/Strain (SSIG)				✓	✓		✓	✓	✓	✓	✓	✓	✓	✓
	Residual Stress (SSR,SSRE)							✓							
	Residual Stress (SSRG)				✓	✓		✓	✓	✓	✓	✓	✓	✓	
	Target Stress/Strain (TSSIE,TSSIA)	✓	✓	✓	✓	✓	✓							✓	✓
	Target Stress/Strain (TSSIG)				✓	✓		✓	✓	✓	✓	✓	✓	✓	✓
	Temperature (TEMP, TMPE)	✓	✓	✓	✓	✓	✓	✓	✓	✓	✓	✓	✓	✓	✓
	Field Load														
	Temp Dependent Loads														
	Overburden									✓	✓	✓	✓		
	Phreatic surface			✓	✓	✓				✓	✓	✓	✓		
Nonlinear geometry	Total Lagrangian				✓	✓			✓	✓	✓	✓	✓	✓	
	Updated Lagrangian				✓				✓						
	Eulerian														
	Co-rotational							✓							
Integration schemes	Explicitly Integrated														
	Numerically Integrated	✓	✓	✓	✓	✓	✓	✓	✓	✓	✓	✓	✓	✓	✓
Mass modelling	Consistent Mass (default)	✓	✓	✓	✓	✓		✓	✓	✓	✓	✓	✓	✓	
	Lumped Mass	✓	✓	✓	✓	✓	✓		✓	✓	✓	✓	✓	✓	✓

Joint Element Summary		Joints							
		JNT3	JPH3	JF3	JAX3	JXS3	JNT4, JL43	JSH4, JL46	JSL4
Product version	LT, Standard (S) or Plus (+)	S	S	S	S	S	S	S	+
Nodal freedoms	U, V	✓			✓				
	U, V, W						✓		
	U, V, qz		✓			✓			
	W, qx, qy			✓					
	U, V, W, qx, qy								
	U, V, W, qx, qy, qz							✓	
	U, V, W, q1, q2								✓
Material properties	Linear								
	Matrix (Stiffness, Mass, Damping)*	✓	✓	✓	✓	✓	✓	✓	✓
	Joint (Stiffness, General)	✓	✓	✓	✓	✓	✓	✓	✓
	Joint (Dynamic, General)	✓	✓	✓	✓	✓	✓	✓	✓
	Joint (Elasto-Plastic)	✓	✓	✓	✓	✓	✓	✓	✓
	Joint (Nonlinear Contact)	✓	✓	✓	✓	✓	✓	✓	✓
	Joint (Nonlinear Friction)	✓	✓	✓	✓	✓	✓	✓	✓
	Viscous damping	✓	✓	✓	✓	✓	✓	✓	✓
	Lead-Rubber	✓	✓	✓	✓	✓	✓	✓	✓
	Friction Pendulum	✓	✓	✓	✓	✓	✓	✓	✓
	Multilinear elastic	✓	✓	✓	✓	✓	✓	✓	✓
	Axial force dependent multilinear elastic	✓	✓	✓	✓	✓	✓	✓	✓
	Concrete								
	Elasto-Plastic								
	Creep								
	Damage								
	Viscoelastic								
	Shrinkage								
	Volumetric Crushing/Foam								
	Rubber								
	Composite								
	Field								
Loading	Prescribed value (PDSP,TPDSP)	✓	✓	✓	✓	✓	✓	✓	✓

Joint Element Summary		Joints							
		JNT3	JPH3	JF3	JAX3	JXS3	JNT4, JL43	JSH4, JL46	JSL4
Product version	LT, Standard (S) or Plus (+)	S	S	S	S	S	S	S	+
types									
	Concentrated Load (CL)	✓	✓	✓	✓	✓	✓	✓	✓
	Element Load								
	Distributed Load								
	Body Force(CBF)	✓	✓	✓	✓	✓	✓	✓	✓
	Body Force (BFP,BFPE)								
	Velocities (VELO)	✓	✓	✓	✓	✓	✓	✓	✓
	Acceleration (ACCE)	✓	✓	✓	✓	✓	✓	✓	✓
	Viscous Support Load (VSL)	✓	✓	✓	✓	✓	✓	✓	✓
	Initial Stress/Strain (SSI,SSIE)	✓	✓	✓	✓	✓	✓	✓	✓
	Initial Stress/Strain (SSIG)								
	Residual Stress								
	Target Stress/Strain (TSSIE, TSSIA)	✓	✓	✓	✓	✓	✓	✓	✓
	Target Stress/Strain (TSSIG)								
	Temperature (TEMP, TMPE)	✓	✓	✓	✓	✓	✓	✓	✓
	Field Load								
	Temp Dependent Load								
Nonlinear geometry	Total Lagrangian								
	Updated Lagrangian								
	Eulerian								
	Co-rotational								
Integration schemes	Explicitly Integrated								
	Numerically Integrated	✓	✓	✓	✓	✓	✓	✓	✓
Mass modelling	Consistent Mass (default)								
	Lumped Mass	✓	✓	✓	✓	✓	✓	✓	✓

* Supported in LUSAS Solver but not supported in LUSAS Modeller for all joints listed.

Thermal / Field Element Summary		Field																			
		BFD2/3	BFX2/3	BFS2/3	LFD2	LFX2	LFS2	TFD3/6, QFD4/8	TFX3/6, QFX4/8	TF4	TF10	PF6	PF12/15	HF8	HF16/20	TF10S	PF6C, HF8C	PF12C, HF16C	TXF3, OXF4	TXF6, QXF8	
Product version	LT, Standard (S) or Plus (+)	S	S	S	S	S	S	S	S	S	S	S	S	S	+	+	+	+	S	S	
Freedom	F	✓	✓	✓	✓	✓	✓	✓	✓	✓	✓	✓	✓	✓	✓	✓	✓	✓	✓	✓	
Material properties	Composite															✓	✓	✓			
	Field (Isotropic)	✓	✓	✓				✓	✓	✓	✓	✓	✓	✓	✓	✓	✓	✓	✓	✓	
	Field (Isotropic Concrete)	✓	✓	✓				✓	✓	✓	✓	✓	✓	✓	✓	✓	✓	✓	✓	✓	
	Field (Orthotropic)							✓	✓	✓	✓	✓	✓	✓	✓	✓	✓	✓	✓	✓	
	Field (Orthotropic Concrete)							✓	✓	✓	✓	✓	✓	✓	✓	✓	✓	✓	✓	✓	
	Field (Linear Conv/Rad)				✓	✓	✓														
	Field (Arbitrary Conv/Rad)				✓	✓	✓														
Loading types	Prescribed (TPDSP)	✓	✓	✓	✓	✓	✓	✓	✓	✓	✓	✓	✓	✓	✓	✓	✓	✓	✓	✓	
	Rate of heat inflow, concentrated (RGN)	✓	✓	✓				✓	✓	✓	✓	✓	✓	✓	✓	✓	✓	✓	✓	✓	
	Face heat and water fluxes (FFL)	✓	✓	✓				✓	✓	✓	✓	✓	✓	✓	✓	✓	✓	✓	✓	✓	
	Rate of heat inflow, per unit volume (RBC, RBV, RBVE)	✓	✓	✓				✓	✓	✓	✓	✓	✓	✓	✓	✓	✓	✓	✓	✓	
	Temperature (TEMP, TMPE)	✓	✓	✓																	
	Environmental	✓	✓	✓				✓	✓	✓	✓	✓	✓	✓	✓	✓	✓	✓	✓	✓	✓

Thermal / Field Element Summary		Field																			
		BFD2/3	BFX2/3	BFS2/3	LFD2	LFX2	LFS2	TFD3/6, OFD4/8	TFX3/6, OFX4/8	TF4	TF10	PF6	PF12/15	HF8	HF16/20	TF10S	PF6C, HF8C	PF12C, HF16C	TXF3, OXF4	TXF6, OXF8	
Product version	LT, Standard (S) or Plus (+)	S	S	S	S	S	S	S	S	S	S	S	S	S	+	+	+	+	S	S	
	conditions (ENVT)																				
	Temp Dep Load (TDET/RIHG)	✓	✓	✓				✓	✓	✓	✓	✓	✓	✓	✓	✓	✓	✓	✓	✓	✓
Schemes	Numerically Integrated	✓	✓	✓	✓	✓	✓	✓	✓	✓	✓	✓	✓	✓	✓	✓	✓	✓	✓	✓	✓
Specific heat	Consistent (default)	✓	✓	✓				✓	✓	✓	✓	✓	✓	✓	✓	✓	✓	✓	✓	✓	✓
	Lumped	✓	✓	✓				✓	✓	✓	✓	✓	✓	✓	✓	✓	✓	✓	✓	✓	✓

Hygro-Thermal Element Summary		Hygro-Thermal							
		THT3/6, OHT4/8	TXHT3/6, QXHT4/8	THT4	THT10	PHT6	PHT12/15	HHT8	HHT16/20
Product version	LT, Standard (S) or Plus (+)	\+	+	+	+	+	+	+	+
Freedoms	T, Pc	✓	✓	✓	✓	✓	✓	✓	✓
Material properties	Hygro-thermal concrete	✓	✓	✓	✓	✓	✓	✓	✓
	Hygro-thermal linear	✓	✓	✓	✓	✓	✓	✓	✓
Loading types	Prescribed temperature and relative humidity (TPDSP)	✓	✓	✓	✓	✓	✓	✓	✓
	Environmental conditions (ENVT)	✓	✓	✓	✓	✓	✓	✓	✓
	Rate of heat and/or water inflow (concentrated) (RGN)	✓	✓	✓	✓	✓	✓	✓	✓
	Rate of heat and/or water inflow per unit area - flux, (FFL)	✓	✓	✓	✓	✓	✓	✓	✓
	Rate of heat and/or water inflow per unit volume (RBC, RBV, RBVE)	✓	✓	✓	✓	✓	✓	✓	✓
	Temperature dependent environmental conditions (TDET)	✓	✓	✓	✓	✓	✓	✓	✓
	Temperature dependent rate of heat and/or water inflow per unit volume (RIHG)	✓	✓	✓	✓	✓	✓	✓	✓
Initial conditions	Initial conditions (TMPE, TMP)	✓	✓	✓	✓	✓	✓	✓	✓
Integration schemes	Numerically Integrated	✓	✓	✓	✓	✓	✓	✓	✓

		Interface						Mass					Rigid Slideline		Phreatic	
Interface, Non-Structural Mass, Rigid Slideline and Phreatic Element Summary		IPN4, IAX4, IPM4	IPN6, IAX6, IPM6	IS6, IS8	IS12, IS16	IPN6P, IAX6P	IS12P, IS16P	PM2	PM3	LMS3, LMS4	LM2, LM3	TM3/6, QM4/8	R2D2	R3D3, R4D3	PHS2	PHS3, PHS4
Product version	LT, Standard (S) or Plus (+)	+	+	+	+	+	+	+	+	+	+	+	+	+	+	
Nodal freedoms	U, V	✓	✓					✓			✓	✓				
	U, V, P					✓										
	U, V, W			✓	✓			✓	✓		✓		✓			
	U, V, W, P						✓									
	U, V, qz															
	W, qx, qy															
	U, V, W, qx, qy															
	U, V, W, qx, qy, qz								✓							
	U, V, W, q1, q2															
Material properties	Linear											✓	✓			
	Matrix															
	Joint															
	Mass							✓	✓	✓	✓	✓				
	Concrete															
	Elasto-Plastic															
	Creep															
	Damage															
	Shrinkage															
	Interface	✓	✓	✓	✓	✓	✓									
	Rubber															
	Generic Polymer															
	Stress Potential															
	Composite															
	Field															
Loading types	Prescribed value (PDSP,TPDSP)	✓	✓	✓	✓	✓	✓					✓	✓			
	Concentrated Loads	✓	✓	✓	✓	✓	✓									

		Interface						Mass					Rigid Slideline		Phreatic	
Interface, Non-Structural Mass, Rigid Slideline and Phreatic Element Summary		IPN4, IAX4, IPM4	IPN6, IAX6, IPM6	IS6, IS8	IS12, IS16	IPN6P, IAX6P	IS12P, IS16P	PM2	PM3	LMS3, LMS4	LM2, LM3	TM3/6, QM4/8	R2D2	R3D3, R4D3	PHS2	PHS3, PHS4
Product version	LT, Standard (S) or Plus (+)	+	+	+	+	+	+	+	+	+	+	+	+	+	+	+
	(CL)															
	Element Load															
	Distributed Load															
	Body Force (CBF)							✓	✓	✓	✓	✓				
	Body Force (BFP,BFPE)															
	Velocity (VELO)	✓	✓	✓	✓								✓	✓		
	Acceleration (ACCE)	✓	✓	✓	✓								✓	✓		
	Viscous Support Load (VSL)	✓	✓	✓	✓	✓	✓									
	Initial Stress/Strain (SSI,SSIE)															
	Initial Stress/Strain (SSIG)															
	Residual Stress															
	Target Stress/Strain (TSSIE,TSSIA)															
	Target Stress/Strain (TSSIG)															
	Temperature (TEMP,TMPE)	✓	✓	✓	✓	✓	✓									
	Field Load															
	Temp Dependent Load															
Nonlinear geometry	Total Lagrangian												✓*	✓*		
	Updated Lagrangian												✓*	✓*		
	Eulerian												✓*	✓*		
	Co-rotational	✓		✓									✓*	✓*		

		Interface						Mass					Rigid Slideline		Phreatic	
Interface, Non-Structural Mass, Rigid Slideline and Phreatic Element Summary		<u>IPN4, IAX4, IPM4</u>	<u>IPN6, IAX6, IPM6</u>	<u>IS6, IS8</u>	<u>IS12, IS16</u>	<u>IPN6P, IAX6P</u>	<u>IS12P, IS16P</u>	<u>PM2</u>	<u>PM3</u>	<u>LMS3, LMS4</u>	<u>LM2, LM3</u>	<u>TM3/6, QM4/8</u>	<u>R2D2</u>	<u>R3D3, R4D3</u>	<u>PHS2</u>	<u>PHS3, PHS4</u>
Product version	LT, Standard (S) or Plus (+)	+	+	+	+	+	+	+	+	+	+	+	+	+	+	+
Integration schemes	Explicitly Integrated															
	Numerically Integrated	✓	✓	✓	✓	✓	✓	✓	✓	✓	✓					
Mass modelling	Consistent Mass (default)						✓	✓	✓	✓	✓					
	Lumped Mass						✓	✓	✓	✓	✓					

* Dependent upon the other surface (deformable surface) that the element is in contact with.

Chapter 1 : Bar Elements

2D Structural Bar Elements

General

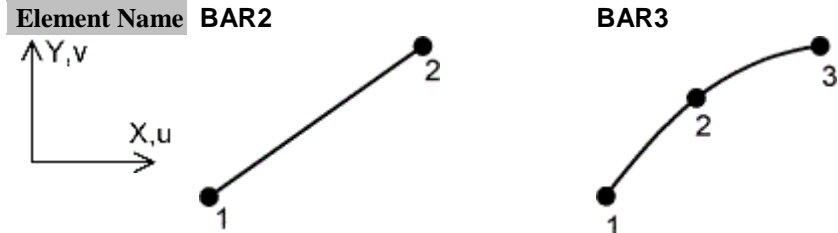

Element Name	BAR2
Element Group	Bars
Element Subgroup	Structural Bars
Element Description	Straight and curved isoparametric bar elements in 2D which can accommodate varying cross sectional area.
Number Of Nodes	2 or 3.
Freedom	U, V at each node
Node Coordinates	X, Y at each node

Geometric Properties

- A1 ... An** Cross sectional area at each node.
- SF1, MF1** Optional scale factor applied to the areas in the calculation of the stiffness and mass matrices

Material Properties

Linear	Isotropic	MATERIAL PROPERTIES (Elastic: Isotropic)
Matrix	Not applicable	
Joint	Not applicable	
Concrete	Not applicable	
Elasto-Plastic	Stress resultant Tresca:	Not applicable MATERIAL PROPERTIES NONLINEAR 61 (Elastic: Isotropic, Plastic: Tresca, Hardening: Isotropic Hardening Gradient, Isotropic Plastic Strain or Isotropic Total Strain)
	Drucker-Prager:	MATERIAL PROPERTIES NONLINEAR 64 (Elastic: Isotropic, Plastic: Drucker-Prager, Hardening: Granular)

	Mohr-Coulomb:	MATERIAL PROPERTIES NONLINEAR 65 (Elastic: Isotropic, Plastic: Mohr-Coulomb, Hardening: Granular with Dilation)
	Optimised Implicit Von Mises:	MATERIAL PROPERTIES NONLINEAR 75 (Elastic: Isotropic, Plastic: Von Mises, Hardening: Isotropic & Kinematic)
	Volumetric Crushing:	Not applicable
	Stress Potential	STRESS POTENTIAL VON_MISES (Isotropic: von Mises, Modified von Mises)
Creep		CREEP PROPERTIES (Creep)
Damage		DAMAGE PROPERTIES SIMO, OLIVER (Damage)
Viscoelastic		VISCO ELASTIC PROPERTIES
Shrinkage		SHRINKAGE CEB_FIP_90, EUROCODE_2, GENERAL, USER
Rubber	Not applicable	
Multi-linear		MATERIAL PROPERTIES NONLINEAR 104
Composite	Not applicable	

Loading

Prescribed Value	PDSP, TPDSP	Prescribed variable. U, V at each node.
Concentrated Loads	CL	Concentrated loads. Px, Py at each node.
Element Loads	Not applicable.	
Distributed Loads	Not applicable.	
Body Forces	CBF	Constant body forces for element. Xcbf, Ycbf, $\Omega_x, \Omega_y, \Omega_z, \alpha_z$
	BFP, BFPE	Body force potentials at nodes/for element. 0, 0, 0, 0, Xcbf, Ycbf
Velocities	VELO	Velocities. Vx, Vy at nodes.
Accelerations	ACCE	Acceleration Ax, Ay at nodes.
Viscous Support Loads	VSL	Viscous support loads. VLx, VLy: at nodes.
Initial Stress/Strains	SSI, SSIE	Initial stresses/strains at nodes/for element. Fx, $\epsilon_x, \sigma_x, \epsilon_x$
	SSIG	Initial stresses/strains at Gauss points. F, $\epsilon_x, \sigma_x, \epsilon_x$
Residual Stresses	SSR, SSRE	Not applicable.
	SSRG	Residual stresses at Gauss points. Components (nonlinear material models): 0, 0,

		σ_x
Target Stress/Strains	TSSIE, TSSIA	Target stresses/strains at nodes/for element. $F_x, \epsilon_x, \sigma_x, \epsilon_x$
	TSSIG	Target stresses/strains at nodes/for element. $F, \epsilon_x, \sigma_x, \epsilon_x$
Temperatures	TEMP, TMPE	Temperatures at nodes/for element. $T, 0, 0, 0, T_0, 0, 0, 0$ in local directions.
Overburden	Not applicable.	
Phreatic Surface	Not applicable.	
Field Loads	Not applicable.	
Temp Dependent Loads	Not applicable.	

LUSAS Output

Solver	Force (default): F_x Strain: ϵ_x
Modeller	See Results Tables (Appendix K)

Local Axes

- [Standard line element](#)

Sign Convention

- [Standard bar element](#)

Formulation

Geometric Nonlinearity

Total Lagrangian	For large displacements and small strains
Updated Lagrangian	Not applicable.
Eulerian	Not applicable.
Co-rotational	For large displacements and small strains.

Integration Schemes

Stiffness	Default.	1-point (BAR2), 2-point (BAR3).
	Fine (see <i>Options</i>).	2-point (BAR2).
Mass	Default.	2-point (BAR2), 3-point (BAR3).

Fine (see *Options*). As default.

Mass Modelling

- Consistent mass (default).
- Lumped mass.

Options

- 18 Invokes fine integration rule for element.
- 55 Outputs strains as well as stresses
- 87 Total Lagrangian geometric nonlinearity.
- 105 Lumped mass matrix.
- 229 Co-rotational geometric nonlinearity.

Notes on Use

1. The bar formulation is based on the standard [isoparametric](#) approach. The variation of axial force is constant for BAR2, and linear for BAR3.
2. Since the 3-noded element has no bending stiffness mechanisms may occur when used as 'stand alone' elements if the central node is not constrained in some way.
3. When the BAR2 element is used with either varying cross-sectional area or temperature dependent material properties, the 2-point Gauss rule should be utilised. This provides an improved representation of the variation of the material properties along the length of the element.
4. Stiffness and mass factors allow different geometric properties to be used in the calculation of the stiffness and mass matrices. Stiffness factors are also used in the processing of stress and strains loads whilst the mass factors are used in the processing of body forces loads. The values are input after all geometric properties and the keyword MODIFICATION_FACTORS must be added to the GEOMETRIC PROPERTIES input command.

Restrictions

- [Ensure mid-side node centrality](#)
- Avoid excessive element curvature

Recommendations on Use

- The 2-node elements are the most effective bar elements for modelling 'stand-alone-elements' such as members of trusses or bars connecting two discrete structures.

- They can be used to model cables in cable-stayed structures.
- Both the 2-noded and 3-noded elements are suitable for modelling reinforcement with continuum elements e.g. BAR3 may be used with QPM8 for analysis of reinforced concrete structures, or for modelling rock bolts surrounding an excavation

Theory

For additional information see the *LUSAS Theory Manual*

3D Structural Bar Elements

General

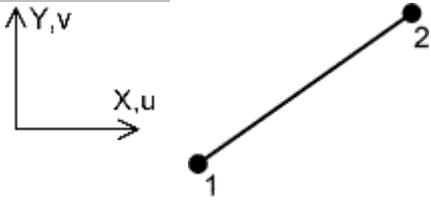
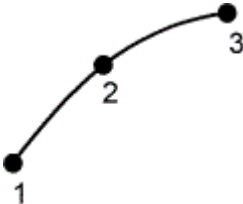
Element Name	BRS2		BRS3	
Element Group	Bars			
Element Subgroup	Structural Bars			
Element Description	Straight and curved isoparametric bar elements in 3D which can accommodate varying cross-sectional area.			
Number Of Nodes	2 or 3.			
Freedom Node Coordinates	U, V, W at each node X, Y, Z at each node.			

Geometric Properties

A1 ... An	Cross sectional area at each node.
SF1, MF1	Optional scale factor applied to the areas in the calculation of the stiffness and mass matrices

Material Properties

Linear	Isotropic	MATERIAL PROPERTIES (Elastic: Isotropic)
Matrix	Not applicable	
Joint	Not applicable	
Concrete	Not applicable	
Elasto-Plastic	Stress resultant	Not applicable
	Tresca:	MATERIAL PROPERTIES NONLINEAR 61 (Elastic: Isotropic, Plastic: Tresca, Hardening: Isotropic Hardening Gradient, Isotropic Plastic Strain or Isotropic Total Strain)
	Drucker-Prager:	MATERIAL PROPERTIES NONLINEAR 64 (Elastic: Isotropic, Plastic: Drucker-Prager,

		Hardening: Granular)
	Mohr-Coulomb:	MATERIAL PROPERTIES NONLINEAR 65 (Elastic: Isotropic, Plastic: Mohr-Coulomb, Hardening: Granular with Dilation)
	Optimised Implicit Von Mises:	MATERIAL PROPERTIES NONLINEAR 75 (Elastic: Isotropic, Plastic: Von Mises, Hardening: Isotropic & Kinematic)
	Volumetric Crushing:	Not applicable
	Stress Potential	STRESS POTENTIAL VON_MISES (Isotropic: von Mises, Modified von Mises)
Creep		CREEP PROPERTIES (Creep)
Damage		DAMAGE PROPERTIES SIMO, OLIVER (Damage)
Viscoelastic		VISCO ELASTIC PROPERTIES
Shrinkage		SHRINKAGE CEB_FIP_90, EUROCODE_2, GENERAL, USER
Multi-linear		MATERIAL PROPERTIES NONLINEAR 104
Rubber	Not applicable	
Composite	Not applicable	

Loading

Prescribed Value	PDSP, TPDSP	Prescribed variable. U, V, W at each node.
Concentrated Loads	CL	Concentrated loads. Px, Py, Pz at each node.
Element Loads	Not applicable	
Distributed Loads	Not applicable	
Body Forces	CBF	Constant body forces for element. Xcbf, Ycbf, Zcbf, Ω_x , Ω_y , Ω_z , α_x , α_y , α_z
	BFP, BFPE	Body force potentials at nodes/for element. 0, 0, 0, 0, Xcbf, Ycbf, Zcbf
Velocities	VELO	Velocities. Vx, Vy, Vz at nodes.
Accelerations	ACCE	Acceleration Ax, Ay, Az at nodes.
Viscous Support Loads	VSL	Viscous support loads. VLx, VLy at nodes.
Initial Stress/Strains	SSI, SSIE	Initial stresses/strains at nodes/for element. Fx, ϵ_x , σ_x , ϵ_x
	SSIG	Initial stresses/strains at Gauss points. F, ϵ_x , σ_x , ϵ_x
Residual Stresses	SSR, SSRE	Not applicable
	SSRG	Residual stresses at Gauss points.

		Components (nonlinear material models): 0, 0, σ_x
Target Stress/Strains	TSSI, TSSIA	Target stresses/strains at nodes/for element. Fx, ϵ_x , σ_x , ϵ_x
	TSSIG	Target stresses/strains at nodes/for element. F, ϵ_x , σ_x , ϵ_x
Temperatures	TEMP, TMPE	Temperatures at nodes/for element. T, 0, 0, 0, To, 0, 0, 0 in local directions.
Overburden	Not applicable.	
Phreatic Surface	Not applicable.	
Field Loads	Not applicable	
Temp Dependent Loads	Not applicable	

LUSAS Output

Solver	Force (default): Fx Strain: ϵ_x
Modeller	See Results Tables (Appendix K)

Local Axes

- [Standard line element](#)

Sign Convention

- [Standard bar element](#)

Formulation

Geometric Nonlinearity

Total Lagrangian	For large displacements and small strains
Updated Lagrangian	Not applicable.
Eulerian	Not applicable.
Co-rotational	For large displacements and small strains.

Integration Schemes

Stiffness	Default.	1-point (BRS2), 2-point (BRS3).
	Fine (see <i>Options</i>).	2-point (BRS2).
Mass	Default.	2-point (BRS2), 3-point (BRS3).

Fine (see *Options*). As default.

Mass Modelling

- Consistent mass (default).
- Lumped mass.

Options

- 18** Invokes fine integration rule for element.
- 55** Outputs strains as well as stresses
- 87** Total Lagrangian geometric nonlinearity.
- 105** Lumped mass matrix.
- 229** Co-rotational geometric nonlinearity.

Notes on Use

1. The bar formulation is based on the standard
2. Since the 3-noded element has no bending stiffness, mechanisms may occur, when used as 'stand alone' elements, if the central node is not constrained in some way.
3. When the BRS2 element is used with either varying cross-sectional area or temperature dependent material properties, the 2-point Gauss rule should be utilised. This provides an improved representation of the variation of the material properties along the length of the element.
4. Stiffness and mass factors allow different geometric properties to be used in the calculation of the stiffness and mass matrices. Stiffness factors are also used in the processing of stress and strains loads whilst the mass factors are used in the processing of body forces loads. The values are input after all geometric properties and the keyword `MODIFICATION_FACTORS` must be added to the `GEOMETRIC PROPERTIES` input command.

Restrictions

- [Ensure mid-side node centrality](#)
- Avoid excessive element curvature

Recommendations on Use

- The 2-node elements are the most effective bar elements for modelling 'stand-alone-elements' such as members of trusses or bars connecting two discrete structures.
- They can be used to model cables in cable-stayed structures.

- Both the 2-noded and 3-noded elements are suitable for modelling reinforcement with continuum elements e.g. BRS3 may be used with HX20 for analysis of reinforced concrete structures, or for modelling rock bolts surrounding an excavation.

Chapter 2 : Beam Elements

2D Engineering Grillage Thick Beam Element

General

Element Name

GRIL

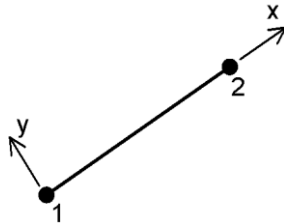
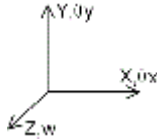

Element Group

Beams

Element

Engineering Beams

Subgroup

Element

A straight grillage element for which shear deformations are included. The geometric properties are constant along the length.

Description

Number Of

2 with moment release end conditions

Nodes

End Releases

The element node numbers should be followed by: R restrained (default), F free defined in the order θ_y at node 1 and then θ_y at node 2 related to local element axes

Freedom

W, θ_x , θ_y : at each node.

Node

X, Y: at each node.

Coordinates

Geometric Properties

A, Iyy, Izz, Jxx, Asz, EFW	for element
ASF1,SF2,SF3,SF4, SF5,SF6	Optional scale factors applied to the geometric properties in the calculation of the stiffness and mass matrices
MF1,MF2,MF3,MF4, MF5,MF6	
A	Cross sectional area
Iyy, Izz	2nd moments of area about local y, z axes (see Definition and <i>Notes</i>)
Jxx	Torsional constant
Asz	Effective shear area on local yz plane in local z directions
EFW	Equivalent plate width

Material Properties

Linear	Isotropic:	MATERIAL PROPERTIES (Elastic: Isotropic)
Matrix	Not applicable	
Joint	Not applicable	
Concrete	Not applicable	
Elasto-Plastic	Not applicable	
Creep	Not applicable	
Damage	Not applicable	
Viscoelastic	Not applicable	
Shrinkage	Not applicable	
Rubber	Not applicable	
Generic Polymer	Not applicable	
Composite	Not applicable.	

Loading

Prescribed Value	PDSP, TPDSP	Prescribed variable. W , θ_x , θ_y : at nodes.
Concentrated Loads	CL	Concentrated loads. P_z , M_x , M_y : at nodes (global).
Element Loads	ELDS	<u>Element loads</u> LTYPE, S1, P_z , M_x , M_y LTYPE=11: point loads and moments in local directions. LTYPE=12: point loads and moments in global directions. LTYPE, 0, W_z , M_x , 0 LTYPE=21: uniformly distributed loads in local directions. LTYPE, S1, W_{z1} , M_{x1} , 0, S2, W_{z2} , M_{x2} , 0 LTYPE=31: distributed loads in local directions.

		LTYPE, S1, Wz, Mx, 0 LTYPE=41: trapezoidal loads in local directions.
Distributed Loads	UDL	Uniformly distributed loads. Wz: Force/unit length in local directions for element (Local z and global Z are coincident).
	FLD, FLDG	Not applicable.
Body Forces	CBF	Constant body forces for element. Zcbf
	BFP, BFPE	Not applicable.
Velocities	VELO	Velocities. Vz: at nodes.
Accelerations	ACCE	Acceleration Az: at nodes.
Viscous Support Loads	VSL	Viscous support loads. VLz nodes.
Initial Stress/Strains	Not applicable.	
Residual Stresses	Not applicable.	
Target Stress/Strains	Not applicable.	
Temperatures	TEMP, TMPE	Temperatures at nodes/for element. 0, 0, 0, dT/dz, 0, 0, 0, dTo/dz: in local directions.
Overburden	Not applicable.	
Phreatic Surface	Not applicable.	
Field Loads	Not applicable.	
Temp Dependent Loads	Not applicable.	

Output

Solver	Force (default): Fz, Mx, My: in local directions (see <i>Notes</i>). Element output is with respect to the beam centre line.
Modeller	See Results Tables (Appendix K) .

Local Axes

- [Standard line element](#)

Sign Convention

- [2D engineering grillage thick beam element](#). Positive external forces and moments acting on the element nodes are in the direction of the local element axes.

Formulation

Geometric Nonlinearity

Not applicable.

Integration Schemes

[Explicitly integrated.](#)

Mass Modelling

- Consistent mass (default).
- Lumped mass.

Options

105 Lumped mass matrix

Notes on Use

- The element formulation is based on the standard grillage element formulation. The force variations along the element are linear shear force, constant torsion and quadratic bending moment.
- The displacement variations along the element are linear torsional rotations and cubic transverse flexural displacements.
- Internal forces and moments are output at intervals of 1/10th of the element length by specifying the Gauss point option from the Output button on the **File** > **LUSAS datafile** dialog.
- The [second moment of area](#) about local z, (I_{zz}), is only required when assembling the mass matrix.
- Strains are not available for GRIL elements.
- Though this element cannot model nonlinear behaviour it can be mixed with other elements in a nonlinear analysis.
- For restrictions on the use of [Wood-Armer](#) with grillages refer to the LUSAS User Guide and Theory Manual.

8. The element has constant material properties along its length. For analyses utilising temperature dependent material properties, the temperature used is the average of the nodal values.
9. A moment release option permits modelling of internal hinges (torsional rotations cannot be released). See [Number of Nodes](#) section.
10. Stiffness and mass factors allow different geometric properties to be used in the calculation of the stiffness and mass matrices. Stiffness factors are also used in the processing of stress and strains loads whilst the mass factors are used in the processing of body forces loads. The values are input after all geometric properties and the keyword MODIFICATION_FACTORS must be added to the GEOMETRIC PROPERTIES input command.

Restrictions

The element does not model material or geometric nonlinear effects.

Recommendations on Use

The element can be used to model two dimensional grillage type structures. Linear, eigen, and dynamic analysis procedures can be used with GRIL elements.

2D Thick Beam Elements

General

Element Name BMI2

BMI3

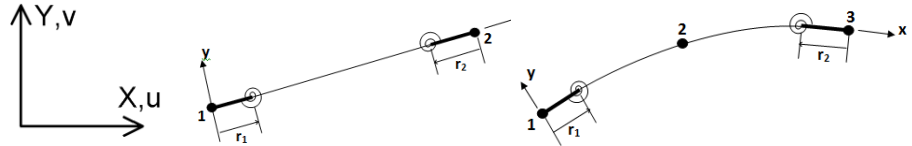

Element Group Beams

Element 2D Thick Beams

Subgroup

Element Description Straight and curved isoparametric degenerate thick beam elements in 2D for which shearing deformations are included. The elements can accommodate varying geometric properties along the length.

Number Of Nodes 2 (BMI2) 3 (BMI3)

Freedom U, V, θ_z at each node.

End Releases The element node numbers should be followed by: R restrained (default) F free defined in the order U, V, θ_z for node 1 and then U, V, θ_z for the other end node (node 2 for BMI2, node 3 for BMI3). The releases relate to the local element axes (see Notes, Assumptions and Limitations).

Partial Fixity Partial fixity at each end node can be defined for all freedoms; this can take the form of a fixity reduction factor or an explicitly defined stiffness value. Partial fixities are defined with respect to the local element axes (see Notes, Assumptions and Limitations).

Rigid Ends Rigid lengths r_1 and r_2 measured from each end node can be specified for these elements. If these lengths are non zero then any end release or partial fixity is applied at the inner point defining the rigid end. A rigidity factor ($1.0 > \lambda > 0.0$) can be specified to make the ends semi-rigid, and options to include/exclude the masses of the rigid ends are also provided (see Notes, Assumptions and Limitations).

Node Coordinates X, Y: at each node.

Geometric Properties

A, Izz, Asy, ey for element

SF1,SF2,SF3,SF4, Optional scale factors applied to the geometric properties in the calculation of the stiffness and mass matrices
MF1,MF2,MF3,MF4

- A** Cross sectional area
- Izz** 2nd moment of area about local z-axis (see [Definition](#))
- Asy** Effective [shear area](#) on local yz plane in local y directions
- ey** [Eccentricity](#) from beam xz-plane to nodal line (+ve in +ve local y-direction)

Note: For MATERIAL MODEL 29 additional geometric properties are appended to the previous 8 (BMI2) or 12 (BMI3) geometric properties (see Notes, Assumptions and Limitations).

Material Properties

Linear	Isotropic:	MATERIAL PROPERTIES (Elastic: Isotropic)
Matrix	Not applicable	
Joint	Not applicable	
Concrete	Not applicable	
Elasto-Plastic	Stress resultant	MATERIAL PROPERTIES NONLINEAR 29 (Elastic: Isotropic, Plastic: Resultant) (ifcode=1 or 2, see Notes, Assumptions and Limitations)
Creep	AASHTO	MATERIAL PROPERTIES NONLINEAR 86 AASHTO (Concrete creep model to AASHTO code of Practice)
	CEB-FIP	MATERIAL PROPERTIES NONLINEAR 86 CEB-FIP (Concrete creep model to CEB-FIP Model Code 1990)
	Chinese	MATERIAL PROPERTIES NONLINEAR 86 CHINESE (Chinese creep model to Chinese Code of Practice)
	Eurocode	MATERIAL PROPERTIES NONLINEAR 86 EUROCODE (Concrete creep model to EUROCODE_2)
	IRC	MATERIAL PROPERTIES NONLINEAR 86 IRC (Concrete creep model to Indian IRC code of Practice)

Damage Not applicable
Viscoelastic Not applicable
Shrinkage

SHRINKAGE CEB_FIP_90,
 EUROCODE_2, GENERAL, USER

Rubber Not applicable
Generic Polymer Not applicable
Composite Not applicable

Loading

Prescribed Value PDSP,
 TPDSP
Concentrated Loads CL
Element Loads ELDS

Prescribed variable. U, V, θ_z : at nodes.

Concentrated loads. Px, Py, Mz: at nodes (global).

Element loads on nodal line (load type number LTYPE *10 defines the corresponding element load type on beam axis, see Notes)

LTYPE, S1, Px, Py, Mz

LTYPE=11: point loads and moments in local directions.

LTYPE=12: point loads and moments in global directions.

LTYPE, 0, Wx, Wy, 0

LTYPE=21: uniformly distributed loads in local directions.

LTYPE=22: uniformly distributed loads in global directions.

LTYPE=23: uniformly distributed projected loads in global directions

LTYPE, S1, Wx1, Wy1, 0, S2, Wx2, Wy2, 0

LTYPE=31: distributed loads in local directions.

LTYPE=32: distributed loads in global directions.

LTYPE=33: distributed projected loads in global directions

LTYPE, S1, Wx, Wy, 0

LTYPE=41: trapezoidal loads in local directions.

LTYPE=42: trapezoidal loads in global directions.

LTYPE=43: trapezoidal projected loads in

		global directions
Distributed Loads	UDL	Uniformly distributed loads. W_x, W_y : forces/unit length for element in local directions.
	FLD	Not applicable.
Body Forces	CBF	Constant body forces for element. $X_{cbf}, Y_{cbf}, \Omega_x, \Omega_y, \Omega_z, \alpha_z$
	BFP, BFPE	Not applicable.
Velocities	VELO	Velocities. V_x, V_y : at nodes.
Accelerations	ACCE	Acceleration. A_x, A_y : at nodes.
Viscous Support Loads	VSL	Viscous support loads. VL_x, VL_y : at nodes.
Initial Stress/Strains	SSI, SSIE	Residual stresses at nodes/for element. Resultants (for material model 29). F_x, F_y, M_z : axial force, shear force and moment in local directions.
Residual Stresses	SSR, SSRE, SSRG	Residual stresses at Gauss points. These stresses are specified in the same manner as SSR and SSRE.
Target Stress/Strains	TSSIE, TSSIA	Target stresses/strains at nodes/for element. F_x, F_y, M_z : axial force, shear force and moment in local directions. $\epsilon_x, \epsilon_y, \psi_z$: axial, shear and flexural strains in local directions.
		Target stresses/strains at Gauss points. These stresses/strains are specified in the same manner as TSSIE and TSSIA.
Temperatures	TEMP, TMPE	Temperatures at nodes/for elements. $T, 0, dT/dy, 0, T_0, 0, dT_0/dy, 0$
Overburden	Not applicable.	
Phreatic Surface	Not applicable.	
Field Loads	Not applicable.	
Temp Dependent Loads	Not applicable.	

LUSAS Output

Solver Stress resultants (default): F_x, F_y, M_z : axial force, shear force and moment in local directions.

Strain: ϵ_x , ϵ_y , ψ_z : Axial, shear and flexural strains in local directions.

By default element output is with respect to the nodal line.

OPTION 418 outputs stress/strain resultants with respect to the beam centroidal axes.

Modeller See [Results Tables \(Appendix K\)](#).

Local Axes

- Standard line element

Sign Convention

- 2D engineering beam element

Formulation

Geometric Nonlinearity

Total Lagrangian	For large displacements and large rotations (see <i>Notes</i>)
Updated Lagrangian	Not applicable.
Eulerian	Not applicable.
Co-rotational	For large displacements and large rotations
P-Delta	Displacements and rotations should be small (see <i>Notes</i>)

Integration Schemes

Stiffness	Default.	1-point (BMI2), 2-point (BMI3).
	Fine.	Same as default.
Mass	Default.	2-point (BMI2), 3-point (BMI3).
	Fine.	Same as default.

Note: A 3-point [Newton-Cotes integration](#) rule is also available for BMI3 using OPTION 134. This may be more applicable for infinitesimal strain, elasto-plastic analyses of plane frames with straight members since the first and third quadrature points will coincide with the frame joints. See Appendix I of the Theory Manual.

Mass Modelling

- Consistent mass (default).
- Lumped mass.

Options

- 36 Follower loads
- 55 Output strains as well as stresses.
- 87 Total Lagrangian geometric nonlinearity. (see Notes)
- 102 Switch off load correction stiffness matrix due to centripetal acceleration
- 105 Lumped mass matrix.
- 134 Gauss to [Newton-Cotes](#) in plane (in the local x direction) integration for elements
- 157 Material model 29 (non cross-section elements), see Notes.
- 229 Co-rotational geometric nonlinearity.
- 403 Introduce residual bending flexibility correction for 2-node thick beam BMI21, see Notes, Assumptions and Limitations (on by default).
- 404 Compute equivalent nodal loading from equilibrium considerations for 2-node thick beam BMI21, see Notes, Assumptions and Limitations (on by default).
- 405 Specify geometric properties along beam centroidal axes
- 406 Specify CBF, UDL, SSI, SSR and TEMP loads along beam centroidal axes
- 418 Output stress resultants relative to beam centroidal axes for eccentric elements
- 421 P-Delta analysis, see Notes
- 432 Use P-Delta geometric stiffness matrix of thick beams for linear buckling analysis

Notes, Assumptions and Limitations

1. The element is formulated from the degenerate continuum concept, i.e. enforcing directly the modified Timoshenko hypothesis for thick beams to the continuum theory. Plane cross-sections initially normal to the beam axis remain plane and undistorted (the shape of the cross-section remains unchanged) under deformation, but do not necessarily remain normal to the beam axis. Shearing deformations are included.
2. Input of geometric properties (OPTION 405) and loads (OPTION 406), and output of stress/strain resultants (OPTION 418) are with respect to the beam centroidal axes. CL is always input with respect to the nodal line; displacements are output with respect to the nodal line.
3. When OPTION 403 is specified to introduce residual bending flexibility correction (on by default), for BMI2, the axial force is constant, while the shear force and moment vary linearly along the length of the beam. For BMI3 the axial force, shear force and moment all vary linearly along the length.
4. When BMI2 is used together with OPTION 403 to introduce residual bending flexibility correction, its stiffness matrix is enhanced to the order of a cubic. Note that if OPTION 403 is used with eccentrically stacked elements, slippage can occur.

5. When BMI2 is used together with OPTION 404, loading that varies along the element length is accounted for in the force diagrams (i.e. for a beam under CBF or internal element loading). A post-processing technique has been introduced to obtain accurate quadratic bending moments for BMI3. For BMI2 (with OPTION 404) and BMI3, internal forces and moments are output at intervals of 1/10th of the element length by specifying the Gauss point option from the Output button of the LUSAS Datafile dialog.
6. The end releases for this element allow a joint to be modelled between adjacent elements. These joints allow rotation and translation of one beam with respect to another without load transferral. The rotations and translations remain in the local directions of the beam elements and support large deformations.
7. For nonlinear material model 29 the following geometric properties are appended to those already specified (see Geometric Properties).
 - A_p , Z_{zzp} , S_p at each node
 - A_p Plastic area (=elastic area)
 - Z_{zzp} Plastic modulus for bending about z axes
 - S_p Plastic area for shear ($S_p=0$).

Note that if eccentricity has been specified the plastic properties must be defined with reference to the nodal line and not the beam axes, i.e. the eccentricity is not used to automatically modify the plastic properties, they must be defined via modified geometry.

For nonlinear material model 29 the following ifcode parameters are applicable: ifcode=1 for circular hollow sections and ifcode=2 for solid rectangular sections.

8. Temperature dependent properties cannot be used with material model 29.
9. The [rigidity matrix](#) is evaluated explicitly from the geometric properties for both linear and nonlinear materials.
10. Stiffness and mass factors allow different geometric properties to be used in the calculation of the stiffness and mass matrices. Stiffness factors are also used in the processing of stress and strains loads whilst the mass factors are used in the processing of body forces loads. The values are input after all geometric properties and the keyword MODIFICATION_FACTORS must be added to the GEOMETRIC PROPERTIES input command.
11. OPTION 36 is only applicable for use with element load types ELDS and UDL. Specifying this option makes these element loads follow the element geometry as the analysis progresses.
12. When a nonlinear material is used with this element the transverse shear stresses are excluded from the plasticity computations i.e. the transverse shear stresses are assumed to remain elastic. This means that if a nonlinear material is

$$\hat{k}_{ij} = \frac{n_{ij}}{1 - n_{ij}} \tilde{k}_{ij}$$

The value of the factor n_{ij} ranges from zero for a pinned connection to 1.0 for a fully fixed connection.

The values r_1 and r_2 are the rigid end lengths at nodes 1 and 2 and λ is the rigidity factor (1.0 = fully rigid, the default). The factors m_1 and m_2 dictate how much mass to include for the rigid ends, full mass = 1.0 (default $m_1=m_2=0.0$).

Restrictions

- [Ensure mid-side node centrality](#)
- Avoid excessive element curvature

Recommendations on Use

- The element may be used for linear and nonlinear analysis of two dimensional beam, frame and arch structures.

2D Thick Beam Element with Quadrilateral Cross-Section

General

Element Name	BMI2X	BMI3X
Element Group	Beams	
Element Subgroup	2D Thick Beams	
Element Description	Straight and curved isoparametric degenerate thick beam elements in 2D for which shearing deformations are included. The elements have a quadrilateral cross section which may vary along its length.	
Number Of Nodes	2 (BMI2X) 3 (BMI3X)	
Freedom	U, V, θ_z : at end nodes.	
End Releases	The element node numbers should be followed by: R restrained (default) F free defined in the order U, V, θ_z for node 1 and then U, V, θ_z for the other end node (node 2 for BMI2X, node 3 for BMI3X). The releases relate to the local element axes (see Notes, Assumptions and Limitations).	
Partial Fixity	Partial fixity at each end node can be defined for all freedoms; this can take the form of a fixity reduction factor or an explicitly defined stiffness value. Partial fixities are defined with respect to the local element axes (see Notes, Assumptions and Limitations).	
Rigid Ends	Rigid lengths r_1 and r_2 measured from each end node can be specified for these elements. If these lengths are non zero then any end release or partial fixity is applied at the inner point defining the rigid end. A rigidity factor ($1.0 > \lambda > 0.0$) can be specified to make the ends semi-rigid, and options to include/exclude the masses of the rigid ends are also provided (see Notes, Assumptions and Limitations).	
Node Coordinates	X, Y: at each node.	

Geometric Properties

$y_1, z_1, y_2, z_2, y_3, z_3, y_4, z_4$: local cross section coordinate pairs at each node; followed by nt_{12}, nt_{14} : specifying the number of **Newton-Cotes integration** points in the direction defined by the local cross-section points 1-2 and 1-4 (zero indicates default values). See *Notes*. Multiple quadrilateral cross-sections can be used to build up complex beam cross-sections.

Note. The coordinates of the cross section are numbered clockwise about the local x-axis (the beam nodal line). That is, a right-hand screw rule in the direction of increasing x.

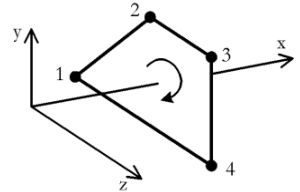

Material Properties

Linear	Isotropic:	MATERIAL PROPERTIES (Elastic: Isotropic)
Matrix	Not applicable	
Joint	Not applicable	
Concrete		MATERIAL PROPERTIES NONLINEAR 109 (Elastic: Isotropic, Plastic: Smoothed Multi Crack Concrete)
Elasto-Plastic	Stress resultant:	Not applicable
	Tresca:	MATERIAL PROPERTIES NONLINEAR 61 (Elastic: Isotropic, Plastic: Tresca, Hardening: Isotropic Hardening Gradient, Isotropic Plastic Strain or Isotropic Total Strain)
	Drucker-Prager:	MATERIAL PROPERTIES NONLINEAR 64 (Elastic: Isotropic, Plastic: Drucker-Prager, Hardening: Granular)
	Mohr-Coulomb:	MATERIAL PROPERTIES NONLINEAR 65 (Elastic: Isotropic, Plastic: Mohr-Coulomb, Hardening: Granular with Dilation)
	Optimised Implicit Von Mises:	MATERIAL PROPERTIES NONLINEAR 75 (Elastic: Isotropic, Plastic: Von Mises, Hardening: Isotropic & Kinematic)
	Volumetric Crushing:	Not applicable
	Stress Potential	STRESS POTENTIAL VON_MISES (Isotropic: von Mises, Modified von Mises)
Creep		CREEP PROPERTIES (Creep)
	AASHTO	MATERIAL PROPERTIES NONLINEAR 86

		AASHTO (Concrete creep model to AASHTO code of Practice)
	CEB-FIP	MATERIAL PROPERTIES NONLINEAR 86 CEB-FIP (Concrete creep model to CEB-FIP Model Code 1990)
	Chinese	MATERIAL PROPERTIES NONLINEAR 86 CHINESE (Chinese creep model to Chinese Code of Practice)
	Eurocode	MATERIAL PROPERTIES NONLINEAR 86 EUROCODE (Concrete creep model to EUROCODE_2)
	IRC	MATERIAL PROPERTIES NONLINEAR 86 IRC (Concrete creep model to Indian IRC code of Practice)
	Damage	DAMAGE PROPERTIES SIMO, OLIVER (Damage)
	Viscoelastic Shrinkage	Not applicable SHRINKAGE CEB_FIP_90, EUROCODE_2, GENERAL, USER
	Rubber	Not applicable
	Generic Polymer	Not applicable
	Composite	Not applicable

Loading

Prescribed Value	PDSP, TPDSP	Prescribed variable. U, V, θ_z : at end nodes. dU at mid-side node.
Concentrated Loads	CL	Concentrated loads. Px, Py, Mz: at end nodes (global). dPx: at mid-side node (local).
Element Loads	ELDS	Element loads on nodal line (load type number LTYPE *10 defines the corresponding element load type on beam axis). LTYPE, S1, Px, Py, Mz LTYPE=11: point loads and moments in local directions. LTYPE=12: point loads and moments in global directions.

		LTYPE, 0, W _x , W _y , M _z
		LTYPE=21: uniformly distributed loads in local directions.
		LTYPE=22: uniformly distributed loads in global directions.
		LTYPE=23: uniformly distributed projected loads in global directions
		LTYPE, S1, W _{x1} , W _{y1} , M _{z1} , S2, W _{x2} , W _{y2} , M _{z2}
		LTYPE=31: distributed loads in local directions.
		LTYPE=32: distributed loads in global directions.
		LTYPE=33: distributed projected loads in global directions
		LTYPE, S1, W _x , W _y , M _z
		LTYPE=41: trapezoidal loads in local directions.
		LTYPE=42: trapezoidal loads in global directions.
		LTYPE=43: trapezoidal projected loads in global directions
Distributed Loads	UDL	Uniformly distributed loads. W _x , W _y : force/unit length in local directions.
	FLD	Not applicable.
Body Forces	CBF	Constant body forces for element. Xcbf, Ycbf, Ω _x , Ω _y , Ω _z , α _z
	BFP, BFPE	Body force potentials at nodes/for element. φ ₁ , φ ₂ , 0, 0, Xcbf, Ycbf
Velocities	VELO	Velocities. V _x , V _y : at nodes.
Accelerations	ACCE	Acceleration A _x , A _y : at nodes
Viscous Support Loads	VSL	Viscous support loads. VL _x , VL _y : at nodes.
Initial Stress/Strains	SSI, SSIE	Target stresses/strains at nodes/for element. Components: F _x , F _y , M _z , ε _x , ε _y , ψ _z , (σ _x , σ _{xy} , ε _x , ε _{xy}) Bracketed terms repeated for each fibre integration point.
	SSIG	Initial stresses/strains at Gauss points. These stresses/strains are specified in the same manner as SSI and SSIE.
Residual Stresses	SSR, SSRE	Residual stresses at nodes/for element. Components: 0, 0, 0, 0, 0, 0, (σ _x , σ _{xy})

		Bracketed terms repeated for each fibre integration point.
	SSRG	Residual stresses at Gauss points. These stresses are specified in the same manner as SSR and SSRE.
Target Stress/Strains	TSSIE, TSSIA	Target stresses/strains at nodes/for element. Components: $F_x, F_y, M_z, \epsilon_x, \epsilon_y, \psi_z, (\sigma_x, \sigma_{xy}, \epsilon_x, \epsilon_{xy})$ Bracketed terms repeated for each fibre integration point.
	TSSIG	Target stresses/strains at Gauss points. These stresses/strains are specified in the same manner as TSSIE and TSSIA.
Temperatures	TEMP, TMPE	Temperatures at nodes/for element $T, 0, dT/dy, 0, T_0, 0, dT_0/dy, 0$: in local directions.
Phreatic surface	Face_Pressure	The fluid pressure is applied in the $-y$ direction of the element y axis.
Field Loads	Not applicable.	
Temp Dependent Loads	Not applicable.	

LUSAS Output

Solver	Stress resultants (default): F_x, F_y, M_z : axial force, shear forces and moment in local directions. Continuum stresses: σ_x, σ_{xy} , in local directions. Strain: $\epsilon_x, \epsilon_y, \psi_z$: Axial, shear and flexural strains in local directions. Continuum strains: $\epsilon_x, \epsilon_{xy}$ in local directions. By default element output is with respect to the nodal line. OPTION 418 outputs stress/strain resultants with respect to the beam centroidal axes.
Modeller	See Results Tables (Appendix K) .

Local Axes

- [Standard line element](#)

Sign Convention

- [Standard beam element](#)

Formulation

Geometric Nonlinearity

Total Lagrangian	For large displacements, small rotations and small strains (see <i>Notes</i>).
Updated Lagrangian	For large displacements, large rotations and small strains.
Eulerian	Not applicable.
Co-rotational	For large displacements and large rotations
P-Delta	Displacements and rotations should be small (see <i>Notes</i>)

Integration Schemes

Stiffness	Default.	1-point (BMI2X), 2-point (BMI3X).
	Fine (see <i>Options</i>).	Same as default.
Mass	Default.	2-point (BMI2X), 3-point (BMI3X).
	Fine (see <i>Options</i>).	Same as default.

A 3-point [Newton-Cotes integration](#) rule is also available for BMI3X using OPTION 134. This may be more applicable for infinitesimal strain, elasto-plastic analyses of plane frames with straight members since the first and third quadrature points will coincide with the frame joints. See Appendix I of the Theory Manual

Mass Modelling

- Consistent mass (default).
- Lumped mass.

Options

- 36** Follower loads
- 55** Output strains as well as stresses
- 87** Total Lagrangian geometric nonlinearity (see *Notes*).
- 102** Switch off load correction stiffness matrix due to centripetal acceleration
- 105** Lumped mass matrix
- 134** Gauss to [Newton-Cotes](#) in plane (in the local x direction) integration for elements.
- 139** Output yielded integration points only
- 229** Co-rotational geometric nonlinearity
- 403** Introduce residual bending flexibility correction for 2-node thick beam BMI21, see Notes, Assumptions and Limitations (on by default).
- 404** Compute equivalent nodal loading from equilibrium considerations for 2-node thick beam BMI2X, see Notes (on by default).

- 406** Specify CBF, UDL, SSI, SSR and TEMP loads along beam centroidal axes
- 418** Output stress resultants relative to beam centroidal axes for eccentric elements
- 421** P-Delta analysis, see Notes
- 432** Use P-Delta geometric stiffness matrix of thick beams for linear buckling analysis

Notes on Use

1. The element is formulated from the degenerate continuum concept, i.e. enforcing directly the modified Timoshenko hypothesis for thick beams to the continuum theory. Plane cross-sections initially normal to the beam axis remain plane and undistorted (the shape of the cross-section remains unchanged) under deformation, but do not necessarily remain normal to the beam axis. Shearing deformations are included.
2. Input of loads (OPTION 406) and output of stress/strain resultants (OPTION 418) are with respect to the beam centroidal axis. CL is always input with respect to the nodal line; displacements are output with respect to the nodal line. Fiber stress/strain results are output at the actual location.
3. When OPTION 403 is specified to introduce residual bending flexibility correction (on by default), for BMI2X, the axial force is constant, while the shear force and moment vary linearly along the length of the beam. For BMI3X the axial force, shear force and moment all vary linearly along the length.
4. When BMI2X is used together with OPTION 403 to introduce residual bending flexibility correction, its stiffness matrix is enhanced to the order of a cubic. Note that if OPTION 403 is used with eccentrically stacked elements, slippage can occur.
5. When BMI2X is used together with OPTION 404, loading that varies along the element length is accounted for in the force diagrams (i.e. for a beam under CBF or internal element loading). Internal forces and moments are output at intervals of 1/10th of the element length by specifying the Gauss point option from the Output button of the LUSAS Datafile dialog.
6. The end releases for this element allow a joint to be modelled between adjacent elements. These joints allow rotation and translation of one beam with respect to another without load transferral. The rotations and translations remain in the local directions of the beam elements and support large deformations
7. OPTION 36 is only applicable for use with element load types ELDS and UDL. Specifying this option makes these element loads follow the element geometry as the analysis progresses.
8. OPTION 229 considers large displacements and large rotations using a co-rotational formulation. When both options 87 and 229 are true, a local Total Lagrangian formulation will be used within a global co-rotational framework. Note that OPTION 87 has no effect when specified without OPTION 229. To

model very flexible members like cables, it is beneficial to use the corotational formulation together with the total Lagrangian formulation to improve convergence and obtain sensible internal displacements.

9. The P-Delta formulation is only applicable to lower order (2-noded) beams, higher order beams used in a P-Delta analysis will default to co-rotational GNL.
10. The Smoothed Multi Crack Concrete Model (109) can be used with this element, however, due to the “plane sections remaining plane” hypothesis, crack widths cannot be computed.
11. Partial fixities and rigid ends are defined via the ELEMENT TOPOLOGY data and follow on the same line after the end releases, for example:

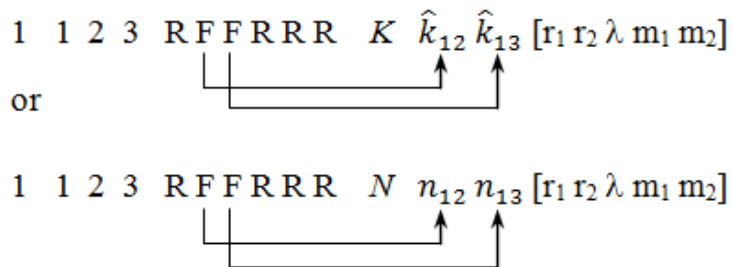

The character K is used to identify that the partial fixity stiffnesses \hat{k}_{12} \hat{k}_{13} are being explicitly defined, while the character N signifies that fixity factors, n_{12} n_{13} are being defined. The fixity factors are used as follows:

$$\hat{k}_{ij} = \frac{n_{ij}}{1 - n_{ij}} \tilde{k}_{ij}$$

The value of the factor n_{ij} ranges from zero for a pinned connection to 1.0 for a fully fixed connection.

The values r_1 and r_2 are the rigid end lengths at nodes 1 and 2 and λ is the rigidity factor (1.0 = fully rigid, the default). The factors m_1 and m_2 dictate how much mass to include for the rigid ends, full mass = 1.0 (default $m_1=m_2=0.0$).

Restrictions

- Ensure mid-side node centrality
- Avoid excessive element curvature

Recommendations on Use

The element may be used for linear and nonlinear analysis of two dimensional beam, frame and arch structures.

3D Thick Beam Elements

General

Element Name

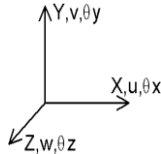

BMI21

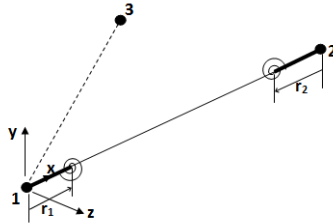

BMI22

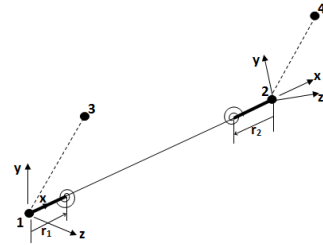

BMI31

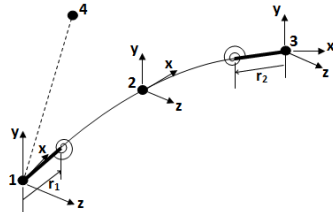

BMI33

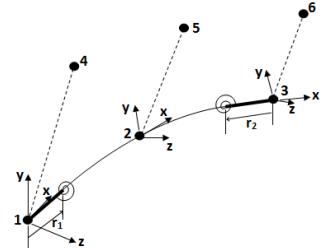

Element Group	Beams
Element Subgroup	Thick Beams
Element Description	Straight and curved isoparametric degenerate thick beam elements in 3D for which shearing deformations are included. The elements can accommodate varying geometric properties along the length. BMI22 and BMI33 can consider initial twist.
Number Of Nodes	3 (BMI21), 4 (BMI22 and BMI31) and 6 (BMI33) with end release conditions.
Freedoms	U, V, W, θ_x , θ_y , θ_z : at each active node.
End Releases	The element node numbers should be followed by: R restrained (default), F free defined in the order U, V, W, θ_x , θ_y , θ_z at node 1 and then U, V, W, θ_x , θ_y , θ_z at node 2 and node 3 (only for BMI31 and BMI33) related to local element axes (see Notes, Assumptions and Limitations).

Partial Fixity	Partial fixity at each end node can be defined for all freedoms; this can take the form of a fixity reduction factor or an explicitly defined stiffness value. Partial fixities are defined with respect to the local element axes (see Notes, Assumptions and Limitations).
End Conditions	Rigid lengths r_1 and r_2 measured from each end node can be specified for these elements. If these lengths are non zero then any end release or partial fixity is applied at the inner point defining the rigid end. A rigidity factor ($1.0 > \lambda > 0.0$) can be specified to make the ends semi-rigid, and options to include/exclude the masses of the rigid ends are also provided (see Notes, Assumptions and Limitations).
Node Coordinates	X, Y, Z: at each node.

Geometric Properties

A, Iyy, Izz, Jxx, Asz, Asy, Iyz, ez, ey	At each node
SF1,SF2,SF3,SF4,SF5,SF6,SF7,SF8,SF9 MF1,MF2,MF3,MF4, MF5,MF6,MF7,MF8,MF9	Optional scale factors applied to the geometric properties in the calculation of the stiffness and mass matrices
A	Cross sectional area.
Iyy, Izz	2nd moment of area about local y, z directions (see Definition).
Jxx	Torsional constant .
Asz, Asy	Effective shear areas on local yz plane in local z, y directions (see shear areas).
Iy, Iz	1st moment of area about local y, z directions (see Definition).
Iyz	Product moment of area about local y, z axes (see Definition).
ez	Eccentricity from beam xy-plane to nodal line. (+ve in the +ve local z direction). (See Notes)
ey	Eccentricity from beam xz-plane to nodal line. (+ve in the +ve local y direction). (See Notes)

Note: For MATERIAL MODEL 29 additional geometric properties are appended to the previous 22 (BMI21 and BMI22) or 33 (BMI31 and BMI33) geometric properties (see Notes, Assumptions and Limitations).

Material Properties

Linear Isotropic:

MATERIAL PROPERTIES (Elastic:

		Isotropic)
	Rigidities:	RIGIDITIES 6 (Rigidities: Beam)
Matrix	Not applicable	
Joint	Not applicable	
Concrete	Not applicable	
Elasto-Plastic	Stress resultant:	MATERIAL PROPERTIES NONLINEAR 29 (Elastic: Isotropic, Plastic: Resultant) (ifcode=1 or 2, see Notes, Assumptions and Limitations)
Creep	AASHTO	MATERIAL PROPERTIES NONLINEAR 86 AASHTO (Concrete creep model to AASHTO Code of Practice)
	CEB-FIP	MATERIAL PROPERTIES NONLINEAR 86 CEB-FIP (Concrete creep model to CEB-FIP Model Code 1990)
	Chinese	MATERIAL PROPERTIES NONLINEAR 86 CHINESE (Chinese creep model to Chinese Code of Practice)
	Eurocode	MATERIAL PROPERTIES NONLINEAR 86 EUROCODE (Concrete creep model to EUROCODE_2)
	IRC	MATERIAL PROPERTIES NONLINEAR 86 IRC (Concrete creep model to Indian IRC Code of Practice)
Damage	Not applicable	
Viscoelastic	Not applicable	
Shrinkage		SHRINKAGE CEB_FIP_90, EUROCODE_2, GENERAL, USER
Rubber	Not applicable	
Generic Polymer	Not applicable	
Composite	Not applicable	

Loading

Prescribed Value	PDSP, TPDSP	Prescribed variable. U, V, W, θ_x , θ_y , θ_z : at active nodes.
-------------------------	-------------	--

Concentrated Loads	CL	Concentrated loads in global directions. Px, Py, Pz, Mx, My, Mz: at active nodes.
Element Loads	ELDS	<p>Element loads on nodal line (load type number LTYPE *10 defines the corresponding element load type on beam axis, see Notes, Assumptions and Limitations) (see Notes, Assumptions and Limitations)</p> <p>LTYPE, S1, Px, Py, Pz, Mx, My, Mz LTYPE=11: point loads and moments in local directions. LTYPE=12: point loads and moments in global directions.</p> <p>LTYPE, 0, Wx, Wy, Wz, Mx, My, Mz LTYPE=21: uniformly distributed loads in local directions. LTYPE=22: uniformly distributed loads in global directions (Mx=0). LTYPE=23: uniformly distributed projected loads in global directions.</p> <p>LTYPE, S1, Wx1, Wy1, Wz1, Mx1, My1, Mz1, S2, Wx2, Wy2, Wz2, Mx2, My2, Mz2 LTYPE=31: distributed loads in local directions. LTYPE=32: distributed loads in global directions. LTYPE=33: distributed projected loads in global directions.</p> <p>LTYPE, S1, Wx, Wy, Wz, Mx, My, Mz LTYPE=41: trapezoidal loads in local directions. LTYPE=42: trapezoidal loads in global directions. LTYPE=43: trapezoidal projected loads in global directions.</p>
Distributed Loads	UDL	Uniformly distributed loads. Wx, Wy, Wz, Mx, My, Mz: local forces and moments / unit length for element (see

	FLD, FLDG	Notes, Assumptions and Limitations).
Body Forces	CBF	Not applicable. Constant body forces for Element. X_{cbf} , Y_{cbf} , Z_{cbf} , Ω_x , Ω_y , Ω_z , α_x , α_y , α_z
	BFP, BFPE	Body force potentials at nodes/for element. ϕ_1 , ϕ_2 , ϕ_3 , 0, X_{cbf} , Y_{cbf} , Z_{cbf}
Velocities	VELO	Velocities. V_x , V_y , V_z : at nodes.
Accelerations	ACCE	Acceleration. A_x , A_y , A_z : at nodes
Viscous Support Loads	VSL	Viscous support loads. VL_x , VL_y , VL_z : at nodes.
Initial Stress/Strains	SSI, SSIE	Initial stresses/strains at nodes/for element. F_x , F_y , F_z , M_x , M_y , M_z : axial force, shear forces, torque and moments in local directions. ϵ_x , ϵ_y , ϵ_z , ψ_x , ψ_y , ψ_z : axial, shear and flexural strains in local directions.
	SSIG	Initial stresses/strains at Gauss points. These stresses/strains are specified in the same manner as SSI and SSIE.
Residual Stresses	SSR, SSRE	Residual stresses at nodes/for element. Resultants (for material model 29). F_x , F_y , F_z , M_x , M_y , M_z : axial force, shear forces, torque and moments in local directions.
	SSRG	Residual stresses at Gauss points. These stresses are specified in the same manner as SSR and SSRE.
Target Stress/Strains	TSSIE, TSSIA	Target stresses/strains at nodes/for element. F_x , F_y , F_z , M_x , M_y , M_z : axial force, shear forces, torque and moments in local directions. ϵ_x , ϵ_y , ϵ_z , ψ_x , ψ_y , ψ_z : axial, shear and flexural strains in local directions.
	TSSIG	Target stresses/strains at Gauss points. These stresses/strains are specified in the same manner as TSSIE and TSSIA.
Temperatures	TEMP, TMPE	Temperatures at nodes/for element. T , 0, dT/dy , dT/dz , T_0 , 0, dT_0/dy , dT_0/dz in local directions
Overburden	Not applicable.	

Phreatic Surface	Not applicable.
Field Loads	Not applicable.
Temp Dependent Loads	Not applicable.

LUSAS Output

Solver	Stress resultants (default): F_x , F_y , F_z , M_x , M_y , M_z : axial force, shear forces, torque and moments in local directions. Strain: ϵ_x , ϵ_y , ϵ_z , ψ_x , ψ_y , ψ_z : Axial, shear, torsional and flexural strains in local directions. By default element output is with respect to the nodal line. OPTION 418 outputs stress/strain resultants with respect to the beam centroidal axes.
Modeller	See Results Tables (Appendix K) .

Local Axes

- [Standard line element](#) For each element/active node, the local xy-plane is defined by the local x-axis and the orientation node. The local y-axis is perpendicular to the local x-axis and positive on the side of the element where the orientation node lies. The local y and z-axes form a right-handed set with the local x-axis. See [Local Element Axes](#) for details

Sign Convention

- [Standard beam element](#)

Formulation

Geometric Nonlinearity

Total Lagrangian	For large displacements and large rotations (see Notes)
Updated Lagrangian	Not applicable.
Eulerian	Not applicable.
Co-rotational	For large displacements and large rotations
P-Delta	Displacements and rotations should be small (see Notes)

Integration Schemes

Stiffness	Default. 1-point (BMI21 and BMI22), 2-point (BMI31 and BMI33). Fine. Same as default.
Mass	Default. 2-point (BMI21 and BMI22), 3-point (BMI31 and BMI33).

Fine. Same as default.

Note: A 3-point [Newton-Cotes integration](#) rule is also available for BMI31 and BMI33 using OPTION 134. This may be more applicable for infinitesimal strain, elasto-plastic analyses of plane frames with straight members since the first and third quadrature points will coincide with the frame joints. See Appendix I of the Theory Manual.

Mass Modelling

- Consistent mass (default).
- Lumped mass.

Options

- 36 Follower loads
- 55 Output strains as well as stresses.
- 87 Total Lagrangian geometric nonlinearity (see Notes).
- 102 Switch off load correction stiffness matrix due to centripetal acceleration
- 105 Lumped mass matrix.
- 134 Gauss to [Newton-Cotes](#) in plane (in the local x direction) integration for elements
- 157 Material model 29 (non cross-section elements), see Notes.
- 229 Co-rotational geometric nonlinearity.
- 403 Introduce residual bending flexibility correction for 2-node thick beam BMI21, see Notes, Assumptions and Limitations (on by default).
- 404 Compute equivalent nodal loading from equilibrium considerations for 2-node thick beam BMI21, see Notes, Assumptions and Limitations.
- 405 Specify geometric properties along beam centroidal axes (on by default).
- 406 Specify CBF, UDL, SSI, SSR and TEMP loads along beam centroidal axes
- 418 Output stress resultants relative to beam centroidal axes for eccentric elements
- 421 P-Delta analysis, see Notes
- 432 Use P-Delta geometric stiffness matrix of thick beams for linear buckling analysis

Notes, Assumptions and Limitations

1. The element is formulated from the so-called degenerate continuum concept, i.e. enforcing directly the modified Timoshenko hypothesis for thick beams to the continuum theory. Plane cross-sections initially normal to the beam axis remain plane and undistorted (the shape of the cross-section remains unchanged) under deformation, but do not necessarily remain normal to the beam axis; the shear centre and centroid of cross-section coincide. Shearing deformations are included. The basic kinematic assumptions correspond to the Timoshenko beam theory and do not allow for warping effects in torsion.

Although warping effects can be considered approximately by using real torsional constants, inaccuracies are likely to occur when eccentricity is present.

2. Input of geometric properties (OPTION 405) and loads (OPTION 406), and output of stress/strain resultants (OPTION 418) are with respect to the beam centroidal axes. CL is always input with respect to the nodal line; displacements are output with respect to the nodal line.
3. When OPTION 403 is specified to introduce residual bending flexibility correction (on by default), for BMI21 and BMI22, the axial force and torsion are constant, while shear forces and moments vary linearly along the length of the beam. For BMI31 and BMI33 the axial force, shear forces, moments and torsion all vary linearly along the length.
4. When BMI21 is used together with OPTION 403 to introduce residual bending flexibility correction, its stiffness matrix is enhanced to the order of a cubic. Note that if OPTION 403 is used with eccentrically stacked elements, slippage can occur.
5. When BMI21 is used together with OPTION 404, loading that varies along the element length is accounted for in the force diagrams (i.e. for a beam under CBF or internal element loading). A post-processing technique has been introduced to obtain accurate quadratic bending moments for BMI31. For BMI21 (with OPTION 404) and BMI31, internal forces and moments are output at intervals of 1/10th of the element length by specifying the Gauss point option from the Output button of the LUSAS Datafile dialog.
6. The end releases for this element allow a joint to be modelled between adjacent elements. These joints allow rotation and translation of one beam with respect to another without load transferral. The rotations and translations remain in the local directions of the beam elements and support large deformations.
7. For nonlinear material model 29 the following geometric properties are appended to those already specified (see Geometric Properties).
 - $A^P, Z_{yy}^P, Z_{zz}^P, Z_y^P, Z_z^P, S^P$ at each node
 - A^P Plastic area (=elastic area)
 - Z_{yy}^P, Z_{zz}^P Plastic moduli for bending about y, z axes
 - Z_y^P, Z_z^P Plastic moduli for torsion about y, z axes.
 - S^P Plastic area for shear ($S^P=0$).

Where the fully plastic torsional moment = $\sigma_y (Z_y^P + Z_z^P)$.

Note that if eccentricity has been specified the plastic properties must be defined with reference to the **nodal line** and **not** the beam axes, i.e. the eccentricity is not

used to automatically modify the plastic properties, they must be defined via modified geometry.

For nonlinear material model 29 the following **ifcode** parameters are applicable: **ifcode=1** for circular hollow sections and **ifcode=2** for solid rectangular sections

8. Temperature dependent properties cannot be used with material model 29.
9. The **rigidity matrix** is evaluated explicitly from the geometric properties for both linear and nonlinear materials.
10. OPTION 36 is only applicable for use with element load types ELDS and UDL. Specifying this option makes these element loads follow the element geometry as the analysis progresses.
11. When a nonlinear material is used with this element the transverse shear stresses are excluded from the plasticity computations i.e. the transverse shear stresses are assumed to remain elastic. This means that if a nonlinear material is used in applications where transverse shear tends to dominate the stress field the equivalent von Mises and maximum principal stresses can exceed the uniaxial yield stress.
12. When a step by step dynamic analysis is carried out using BMI elements with distributed loading, the "free body force diagrams" pertaining to applied loading, are not superimposed on the nodal values, to do so would lead to erroneous results until a steady state is reached. It should therefore be noted that different force diagrams will be obtained for BMI elements if static and dynamic analyses are directly compared.
13. OPTION 229 considers large displacements and large rotations using a co-rotational formulation. When both options 87 and 229 are true, a local Total Lagrangian formulation will be used within a global co-rotational framework. Note that OPTION 87 has no effect when specified without OPTION 229. To model very flexible members like cables, it is beneficial to use the corotational formulation together with the total Lagrangian formulation to improve convergence and obtain sensible internal displacements.
14. Stiffness and mass factors allow different geometric properties to be used in the calculation of the stiffness and mass matrices. Stiffness factors are also used in the processing of stress and strains loads whilst the mass factors are used in the processing of body forces loads. The values are input after all geometric properties and the keyword MODIFICATION_FACTORS must be added to the GEOMETRIC PROPERTIES input command.
15. The P-Delta formulation is only applicable to lower order (2-noded) beams, higher order beams used in a P-Delta analysis will default to co-rotational GNL.
16. Partial fixities and rigid ends are defined via the ELEMENT TOPOLOGY data and follow on the same line after the end releases, for example:

3D Thick Beam Elements with Quadrilateral Cross-Section

General

Element Name

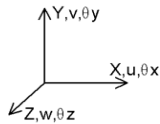

BMX21

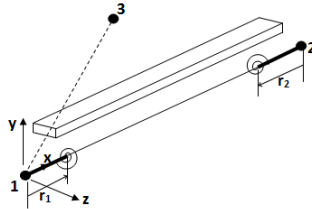

BMX22

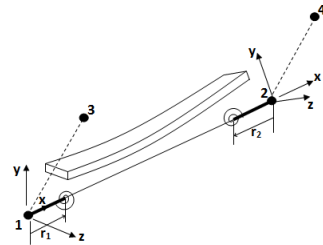

BMX31

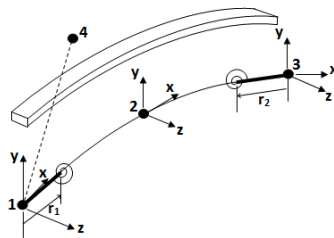

BMX33

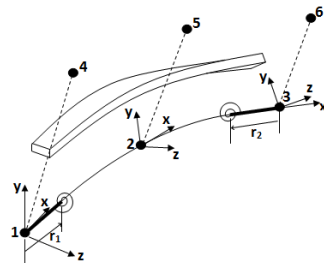

Element Group	Beams
Element Subgroup	Thick Beams
Element Description	Straight and curved isoparametric degenerate thick beam elements in 3D for which shearing deformations are included. The element has a quadrilateral cross section which may vary along the element length. BMX22 and BMX33 can consider initial twist.
Number Of Nodes	3 (BMX21), 4 (BMX22 and BMX31) and 6 (BMX33) with end release conditions.
Freedoms	U, V, W, θ_x , θ_y , θ_z : at each active node.
End Releases	The element node numbers should be followed by: R restrained (default), F free defined in the order U, V, W, θ_x , θ_y , θ_z at node 1 and then U, V, W, θ_x , θ_y , θ_z at node 2 and node 3 (only for

Partial Fixity	BMX31 and BMX33) related to local element axes (see Notes). Partial fixity at each end node can be defined for all freedoms; this can take the form of a fixity reduction factor or an explicitly defined stiffness value. Partial fixities are defined with respect to the local element axes (see Notes, Assumptions and Limitations).
End Conditions	Rigid lengths r_1 and r_2 measured from each end node can be specified for these elements. If these lengths are non zero then any end release or partial fixity is applied at the inner point defining the rigid end. A rigidity factor ($1.0 > \lambda > 0.0$) can be specified to make the ends semi-rigid, and options to include/exclude the masses of the rigid ends are also provided (see Notes, Assumptions and Limitations).
Node Coordinates	X, Y, Z: at each node.

Geometric Properties

$y_1, z_1, y_2, z_2, y_3, z_3, y_4, z_4$: local cross section coordinate pairs at each node; followed by $nt12, nt14$: number of [Newton-Cotes](#) integration points in the direction defined by the local cross-section points 1-2 and 1-4 (zero indicates default values). Multiple quadrilateral cross-sections can be used to build up complex beam cross-sections.

Note. The corners of the quadrilateral are numbered clockwise about the local x-axis (the beam nodal line), that is, a right-hand screw rule in the direction of increasing x.

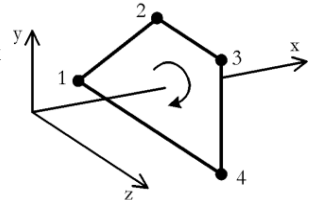

Material Properties

Linear	Isotropic:	MATERIAL PROPERTIES (Elastic: Isotropic)
Matrix	Not applicable	
Joint	Not applicable	
Concrete		MATERIAL PROPERTIES NONLINEAR 109 (Elastic: Isotropic, Plastic: Smoothed Multi Crack Concrete)
Elasto-Plastic	Stress resultant: Tresca:	Not applicable. MATERIAL PROPERTIES NONLINEAR 61 (Elastic: Isotropic, Plastic: Tresca, Hardening: Isotropic Hardening Gradient, Isotropic Plastic Strain or Isotropic Total Strain)
	Drucker-Prager:	MATERIAL PROPERTIES NONLINEAR

		64 (Elastic: Isotropic, Plastic: Drucker-Prager, Hardening: Granular)
	Mohr-Coulomb:	MATERIAL PROPERTIES NONLINEAR 65 (Elastic: Isotropic, Plastic: Mohr-Coulomb, Hardening: Granular with Dilation)
	Optimised Implicit Von Mises:	MATERIAL PROPERTIES NONLINEAR 75 (Elastic: Isotropic, Plastic: Von Mises, Hardening: Isotropic & Kinematic)
	Volumetric Crushing:	Not applicable.
	Stress Potential	STRESS POTENTIAL VON_MISES (Isotropic: von Mises, Modified von Mises)
Creep		CREEP PROPERTIES (Creep)
	AASHTO	MATERIAL PROPERTIES NONLINEAR 86 AASHTO (Concrete creep model to AASHTO code of Practice)
	CEB-FIP	MATERIAL PROPERTIES NONLINEAR 86 CEB-FIP (Concrete creep model to CEB-FIP Model Code 1990)
	Chinese	MATERIAL PROPERTIES NONLINEAR 86 CHINESE (Chinese creep model to Chinese Code of Practice)
	Eurocode	MATERIAL PROPERTIES NONLINEAR 86 EUROCODE (Concrete creep model to EUROCODE_2)
	IRC	MATERIAL PROPERTIES NONLINEAR 86 IRC (Concrete creep model to Indian IRC code of Practice)
Damage		DAMAGE PROPERTIES SIMO, OLIVER (Damage)
Viscoelastic Shrinkage	Not applicable	SHRINKAGE CEB_FIP_90, EUROCODE_2, GENERAL, USER
Rubber	Not applicable	
Generic Polymer	Not applicable	

Composite Not applicable

Loading

Prescribed Value PDSP, TPDSP

Prescribed variable. U, V, W, θ_x , θ_y , θ_z : at active nodes.

Concentrated Loads CL

Concentrated loads in global directions. P_x , P_y , P_z , M_x , M_y , M_z : at active nodes (global).

Element Loads ELDS

Element loads on nodal line (load type number LTYPE *10 defines the corresponding element load type on beam axis, see Notes, Assumptions and Limitations)

LTYPE, S1, P_x , P_y , P_z , M_x , M_y , M_z

LTYPE=11: point loads and moments in local directions.

LTYPE=12: point loads and moments in global directions.

LTYPE, 0, W_x , W_y , W_z , M_x , M_y , M_z

LTYPE=21: uniformly distributed loads in local directions.

LTYPE=22: uniformly distributed loads in global directions ($M_x=0$).

LTYPE=23: uniformly distributed projected loads in global directions.

LTYPE, S1, W_{x1} , W_{y1} , W_{z1} , M_{x1} , M_{y1} , M_{z1} , S2, W_{x2} , W_{y2} , W_{z2} , M_{x2} , M_{y2} , M_{z2}

LTYPE=31: distributed loads in local directions.

LTYPE=32: distributed loads in global directions.

LTYPE=33: distributed projected loads in global directions.

LTYPE, S1, W_x , W_y , W_z , M_x , M_y , M_z

LTYPE=41: trapezoidal loads in local directions.

LTYPE=42: trapezoidal loads in global directions.

LTYPE=43: trapezoidal projected

		loads in global directions.
Distributed Loads	UDL	Uniformly distributed loads. $W_x, W_y, W_z, M_x, M_y, M_z$: local forces and moments / unit length for element in local directions. see Notes, Assumptions and Limitations.
	FLD	Not applicable.
Body Forces	CBF	Constant body forces for Element. $X_{cbf}, Y_{cbf}, Z_{cbf}, \Omega_x, \Omega_y, \Omega_z, \alpha_x, \alpha_y, \alpha_z$
	BFP, BFPE	Body force potentials at nodes/for element. $\phi_1, \phi_2, \phi_3, 0, X_{cbf}, Y_{cbf}, Z_{cbf}$
Velocities	VELO	Velocities. V_x, V_y, V_z : at nodes.
Viscous Support Loads	VSL	Viscous support loads. VL_x, VL_y, VL_z : at nodes.
Accelerations	ACCE	Acceleration. A_x, A_y, A_z : at nodes
Initial Stress/Strains	SSI, SSIE	Initial stresses/strains at nodes/for element. Components: $F_x, F_y, F_z, M_x, M_y, M_z, \epsilon_x, \epsilon_y, \epsilon_z, \psi_x, \psi_y, \psi_z, (\sigma_x, \sigma_{xy}, \sigma_{xz}, \epsilon_x, \epsilon_{xy}, \epsilon_{xz})$ Bracketed terms repeated for each fibre integration point.
	SSIG	Initial stresses/strains at Gauss points. These stresses/strains are specified in the same manner as SSI and SSIE.
Residual Stresses	SSR, SSRE	Residual stresses at nodes/for element. Components: $0, 0, 0, 0, 0, 0, 0, 0, 0, 0, 0, 0, (\sigma_x, \sigma_{xy}, \sigma_{xz})$ Bracketed terms repeated for each fibre integration point.
	SSRG	Residual stresses at Gauss points. These stresses are specified in the same manner as SSR and SSRE.
Target Stress/Strains	TSSIE, TSSIA	Target stresses/strains at nodes/for element. Components: $F_x, F_y, F_z, M_x, M_y, M_z, \epsilon_x, \epsilon_y, \epsilon_z, \psi_x, \psi_y, \psi_z, (\sigma_x, \sigma_{xy}, \sigma_{xz}, \epsilon_x, \epsilon_{xy}, \epsilon_{xz})$ Bracketed terms repeated for each fibre integration point.
	TSSIG	Target stresses/strains at Gauss points. These stresses/strains are specified in the same manner as TSSIE and TSSIA.

Temperatures	TEMP, TMPE	Temperatures at nodes/for element. T, 0, dT/dy, dT/dz, To, 0, dTo/dy, dTo/dz in local directions
Overburden	Not applicable.	
Phreatic Surface	Not applicable.	
Field Loads	Not applicable.	
Temp Dependent Loads	Not applicable.	

LUSAS Output

Solver	Stress resultants (default): Fx, Fy, Fz, Mx, My, Mz: axial force, shear forces, torque and moments in local directions. Continuum stresses (OPTION 172): σ_x , σ_{xy} , σ_{xz} : in local directions. Strain: ϵ_x , ϵ_y , ϵ_z , ψ_x , ψ_y , ψ_z : Axial, shear, torsional and flexural strains in local directions. Continuum strains (OPTION 172): ϵ_x , ϵ_{xy} , ϵ_{xz} : in local directions. By default element output is with respect to the nodal line. OPTION 418 outputs stress/strain resultants with respect to the beam centroidal axes.
Modeller	See Results Tables (Appendix K) .

Local Axes

- [Standard line element](#) For each element/active node, the local xy-plane is defined by the local x-axis and the orientation node. The local y-axis is perpendicular to the local x-axis and positive on the side of the element where the orientation node lies. The local y and z-axes form a right-handed set with the local x-axis. See [Local Element Axes](#) for details

Sign Convention

- [Standard beam element](#)

Formulation

Geometric Nonlinearity

Total Lagrangian	For large displacements and rotations (see Notes)
Updated Lagrangian	Not applicable.
Eulerian	Not applicable.

- Corotational** For large displacements and rotations
P-Delta Displacements and rotations should be small (see Notes)

Integration Schemes

- Stiffness** Default. 1-point (BMX21 and BMX22), 2-point (BMX31 and BMX33).
Fine. Same as default.
- Mass** Default. 2-point (BMX21 and BMX22), 3-point (BMX31 and BMX33).
Fine. Same as default.

Note: A 3-point [Newton-Cotes integration](#) rule is also available for BMX31 and BMX33 using OPTION 134. This may be more applicable for infinitesimal strain, elasto-plastic analyses of plane frames with straight members since the first and third quadrature points will coincide with the frame joints. See Appendix I of the Theory Manual.

Mass Modelling

- Consistent mass (default).
- Lumped mass.

Options

- 36** Follower loads
- 55** Output strains as well as stresses.
- 87** Total Lagrangian geometric nonlinearity (see Notes).
- 102** Switch off load correction stiffness matrix due to centripetal acceleration
- 105** Lumped mass matrix.
- 134** Gauss to [Newton-Cotes](#) in plane (in the local x direction) integration for elements.
- 139** Output yielded integration points only.
- 172** Form the [rigidity matrix](#) by numerical cross section integration.
- 229** Co-rotational geometric nonlinearity.
- 403** Introduce residual bending flexibility correction for 2-node thick beam BMI21, see Notes, Assumptions and Limitations (on by default).
- 404** Compute equivalent nodal loading from equilibrium considerations for 2-node thick beam BMX21, see Notes (on by default).
- 406** Specify CBF, UDL, SSI, SSR and TEMP loads along beam centroidal axes
- 418** Output stress resultants relative to beam centroidal axes for eccentric elements
- 421** P-Delta analysis, see Notes
- 432** Use P-Delta geometric stiffness matrix of thick beams for linear buckling analysis

Notes, Assumptions and Limitations

1. The element is formulated from the so-called degenerate continuum concept, i.e. enforcing directly the modified Timoshenko hypothesis for thick beams to the continuum theory. Plane cross-sections initially normal to the beam axis remain plane and undistorted (the shape of the cross-section remains unchanged) under deformation, but do not necessarily remain normal to the beam axis; the shear centre and centroid of cross-section coincide. Shearing deformations are included.
2. Input of loads (OPTION 406) and output of stress/strain resultants (OPTION 418) are with respect to the beam centroidal axis. CL is always input with respect to the nodal line; displacements are output with respect to the nodal line. Fiber stress/strain results are output at the actual location.
3. When OPTION 403 is specified to introduce residual bending flexibility correction (on by default), for BMX21 and BMX22, the axial force and torsion are constant, while shear forces and moments vary linearly along the length of the beam. For BMX31 and BMX33 the axial force, shear forces, moments and torsion all vary linearly along the length.
4. When BMX21 is used together with OPTION 403 to introduce residual bending flexibility correction, its stiffness matrix is enhanced to the order of a cubic. Note that if OPTION 403 is used with eccentrically stacked elements, slippage can occur.
5. When BMX21 is used together with OPTION 404, loading that varies along the element length is accounted for in the force diagrams (i.e. for a beam under CBF or internal element loading). Internal forces and moments are output at intervals of 1/10th of the element length by specifying the Gauss point option from the Output button of the LUSAS Datafile dialog.
6. The end releases for this element allow a joint to be modelled between adjacent elements. These joints allow rotation and translation of one beam with respect to another without load transferral. The rotations and translations remain in the local directions of the beam elements and support large deformations.
7. Computation of the [rigidity matrix](#) by integration through the cross-section depth of the beam is necessary for all nonlinear material models. By default OPTION 172 is invoked automatically and a 5*5 point [Newton-Cotes integration](#) rule is used. This allows the output of stresses at the numerical cross section integration points.
8. By default, the [rigidity matrix](#) is evaluated explicitly for linear materials. A 3*3 point [Newton-Cotes integration](#) rule may be invoked using OPTION 172. Numerical cross section integration enables top, middle and bottom stress output.

9. OPTION 36 is only applicable for use with element load types ELDS and UDL. Specifying this option makes these element loads follow the element geometry as the analysis progresses.
10. For nonlinear material models, fibre integration is used across the cross-sectional area of the beam. Only axial deformation is considered in the plasticity computations, any torsional deformation is assumed to remain elastic.
11. OPTION 229 considers large displacements and large rotations using a co-rotational formulation. When both options 87 and 229 are true, a local Total Lagrangian formulation will be used within a global co-rotational framework. Note that OPTION 87 has no effect when specified without OPTION 229. To model very flexible members like cables, it is beneficial to use the corotational formulation together with the total Lagrangian formulation to improve convergence and obtain sensible internal displacements.
12. The P-Delta formulation is only applicable to lower order (2-noded) beams, higher order beams used in a P-Delta analysis will default to co-rotational GNL.
13. The Smoothed Multi Crack Concrete Model (109) can be used with this element, however, due to the “plane sections remaining plane” hypothesis, crack widths cannot be computed.
14. Partial fixities and rigid ends are defined via the ELEMENT TOPOLOGY data and follow on the same line after the end releases, for example:

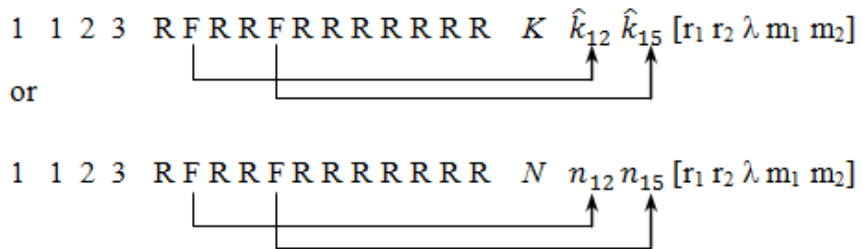

The character K is used to identify that the partial fixity stiffnesses k_{12} k_{15} are being explicitly defined, while the character N signifies that fixity factors, n_{12} n_{15} are being defined. The fixity factors are used as follows:

$$\hat{k}_{ij} = \frac{n_{ij}}{1 - n_{ij}} \tilde{k}_{ij}$$

The value of the factor n_{ij} ranges from zero for a pinned connection to 1.0 for a fully fixed connection.

The values r_1 and r_2 are the rigid end lengths at nodes 1 and 2 and λ is the rigidity factor (1.0 = fully rigid, the default). The factors m_1 and m_2 dictate how much mass to include for the rigid ends, full mass = 1.0 (default $m_1=m_2=0.0$).

Restrictions

- Ensure mid-side node centrality
- Avoid excessive element curvature
- BMX22 and BMX33 elements are not available for selection currently within LUSAS Modeller.

Recommendations on Use

- The elements may be used for linear and nonlinear analysis of three dimensional beam, frame and arch structures. BMX21 and BMX22 may also be used as a stiffener for the QTS4 shell element; while BMX31 and BMX33 may be used as a stiffener for the QTS8 shell element.

3D Thick Beam Elements with Torsional Warping

General

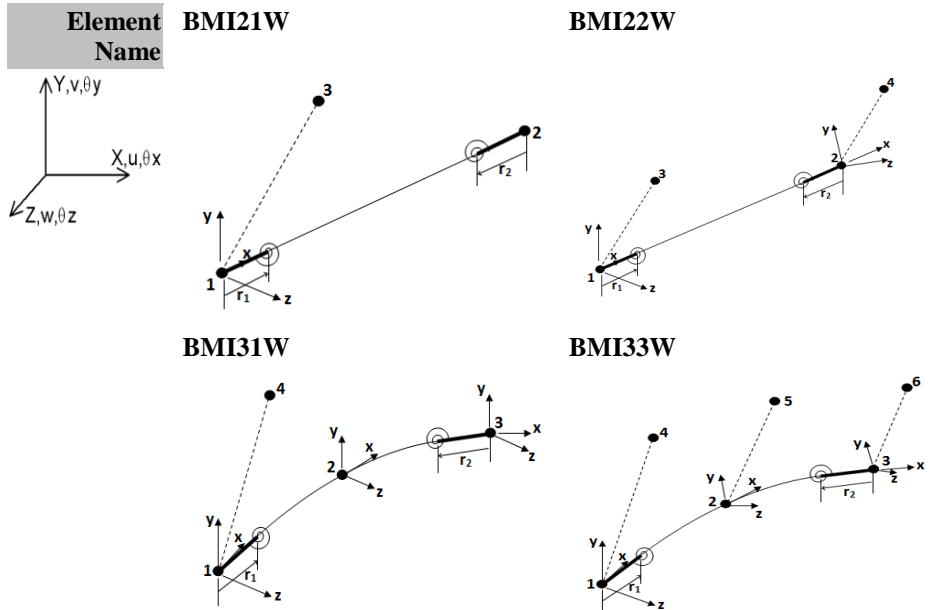

Partial Fixity	element axes (see Notes, see Notes, Assumptions and Limitations).). Partial fixity at each end node can be defined for all freedoms; this can take the form of a fixity reduction factor or an explicitly defined stiffness value. Partial fixities are defined with respect to the local element axes (see Notes, Assumptions and Limitations).
End Conditions	Rigid lengths r_1 and r_2 measured from each end node can be specified for these elements. If these lengths are non zero then any end release or partial fixity is applied at the inner point defining the rigid end. A rigidity factor ($1.0 > \lambda > 0.0$) can be specified to make the ends semi-rigid, and options to include/exclude the masses of the rigid ends are also provided (see Notes, Assumptions and Limitations).
Node Coordinates	X, Y, Z: at each node.

Geometric Properties

<p>A, Iyy, Izz, Jxx, Asz, Asy, Iy, Iz, Iyz, Cw, Cwy, Cwz, Iyr, Izr, Irr, Iwr (default) or A, Iyy, Izz, Jxx, Asz, Asy, ez, ey, Iyz, Cw, zo, yo, Iyr, Izr, Irr, Iwr (option 405)</p> <p>SF1,SF2,SF3,SF4,SF5,SF6,SF7,SF8,SF9, SF10,SF11,SF12,SF13, SF14,SF15,SF16</p> <p>MF1,MF2,MF3,MF4,MF5,MF6,MF7,MF8, MF9,MF10,MF11,MF12,MF13,MF14,MF15,MF16</p>	<p>At each node</p> <p>Optional scale factors applied to the geometric properties in the calculation of the stiffness and mass matrices</p> <p>A Cross sectional area.</p> <p>Iyy, Izz 2nd moment of area about local y, z directions (see Definition).</p> <p>Jxx Torsional constant.</p> <p>Asz, Asy Effective shear areas on local yz plane in local z, y directions (see shear areas).</p> <p>Iy, Iz 1st moment of area about local y, z directions (see Definition).</p> <p>Iyz Product moment of area about local y, z axes (see Definition).</p> <p>Cw Warping constant (see Definition).</p>
---	--

Cwy, Cwz 1st moment of warping about local y, z directions (see [Definition](#)).

ez Eccentricity from beam xy-plane to nodal line. (+ve in the +ve local z direction). (See Notes)

ey Eccentricity from beam xz-plane to nodal line. (+ve in the +ve local y direction). (See Notes)

Zo z-coordinate of the shear center with respect to the centroid (+ve in +ve local z-direction)

Yo y-coordinate of the shear center with respect to the centroid (+ve in +ve local y-direction)

Iyr, Izr, Irr, Iwr Wagner constants. (See Notes)

Material Properties

Linear Isotropic:

Rigidities:

Matrix Not applicable

Joint Not applicable

Concrete Not applicable

Elasto-Plastic Stress resultant:

Creep AASHTO

CEB-FIP

MATERIAL PROPERTIES (Elastic: Isotropic)

RIGIDITIES 6 (Rigidities: Beam)

MATERIAL PROPERTIES NONLINEAR 29

(Elastic: Isotropic, Plastic: Resultant) (ifcode=1 or 2, see Notes, Assumptions and Limitations)

MATERIAL PROPERTIES NONLINEAR 86 AASHTO

(Concrete creep model to AASHTO code of Practice)

MATERIAL PROPERTIES NONLINEAR 86 CEB-FIP

(Concrete creep model to CEB-FIP Model Code 1990)

	Chinese	MATERIAL PROPERTIES NONLINEAR 86 CHINESE (Chinese creep model to Chinese Code of Practice)
	Eurocode	MATERIAL PROPERTIES NONLINEAR 86 EUROCODE (Concrete creep model to EUROCODE_2)
	IRC	MATERIAL PROPERTIES NONLINEAR 86 IRC (Concrete creep model to Indian IRC code of Practice)
Damage	Not applicable	
Viscoelastic	Not applicable	
Shrinkage		SHRINKAGE CEB_FIP_90, EUROCODE_2, GENERAL, USER
Rubber	Not applicable	
Generic Polymer	Not applicable	
Composite	Not applicable	

Loading

Prescribed Value	PDSP, TPDSP	Prescribed variable. U, V, W, θ_x , θ_y , θ_z , α : at active nodes.
Concentrated Loads	CL	Concentrated loads in global directions. Px, Py, Pz, Mx, My, Mz, Mb: at active nodes.
Element Loads	ELDS	Element loads on nodal line (load type number LTYPE *10 defines the corresponding element load type on beam axis, see Notes, Assumptions and Limitations) (see Notes, Assumptions and Limitations) LTYPE, S1, Px, Py, Pz, Mx, My, Mz LTYPE=11: point loads and moments in local directions. LTYPE=12: point loads and moments in global directions. LTYPE, 0, Wx, Wy, Wz, Mx, My, Mz LTYPE=21: uniformly distributed loads in local directions. LTYPE=22: uniformly distributed loads in global

		directions (Mx=0).
		LTYPE=23: uniformly distributed projected loads in global directions.
		LTYPE, S1, Wx1, Wy1, Wz1, Mx1, My1, Mz1, S2, Wx2, Wy2, Wz2, Mx2, My2, Mz2
		LTYPE=31: distributed loads in local directions.
		LTYPE=32: distributed loads in global directions.
		LTYPE=33: distributed projected loads in global directions.
		LTYPE, S1, Wx, Wy, Wz, Mx, My, Mz
		LTYPE=41: trapezoidal loads in local directions.
		LTYPE=42: trapezoidal loads in global directions.
		LTYPE=43: trapezoidal projected loads in global directions.
	DLDL, DLDG	Not applicable.
	DLEL, DLEG	Not applicable.
	PLDL, PLDG	Not applicable.
Distributed Loads	UDL	Uniformly distributed loads. Wx, Wy, Wz, Mx, My, Mz: local forces and moments / unit length for element (see Notes, Assumptions and Limitations).
	FLD, FLDG	Not applicable.
Body Forces	CBF	Constant body forces for Element. Xcbf, Ycbf, Zcbf, Ω_x , Ω_y , Ω_z , α_x , α_y , α_z
	BFP, BFPE	Body force potentials at nodes/for element. ϕ_1 , ϕ_2 , ϕ_3 , 0, Xcbf, Ycbf, Zcbf
Velocities	VELO	Velocities. Vx, Vy, Vz: at nodes.
Accelerations	ACCE	Acceleration. Ax, Ay, Az: at nodes
Viscous Support Loads	VSL	Viscous support loads. VLx, VLy, VLz: at nodes.
Initial	SSI, SSIE	Initial stresses/strains at nodes/for

Stress/Strains		element. Fx, Fy, Fz, Mx, My, Mz, 0, 0: axial force, shear forces, torque and moments in local directions. ϵ_x , ϵ_y , ϵ_z , ψ_x , ψ_y , ψ_z , 0, 0: axial, shear and flexural strains in local directions.
	SSIG	Initial stresses/strains at Gauss points. These stresses/strains are specified in the same manner as SSI and SSIE.
Residual Stresses	SSR, SSRE	Residual stresses at nodes/for element. Resultants (for material model 29). Fx, Fy, Fz, Mx, My, Mz: axial force, shear forces, torque and moments in local directions.
	SSRG	Residual stresses at Gauss points. These stresses are specified in the same manner as SSR and SSRE.
Target Stress/Strains	TSSIE, TSSIA	Target stresses/strains at nodes/for element. Fx, Fy, Fz, Mx, My, Mz, 0,0: axial force, shear forces, torque and moments in local directions. ϵ_x , ϵ_y , ϵ_z , ψ_x , ψ_y , ψ_z , 0, 0: axial, shear and flexural strains in local directions.
	TSSIG	Target stresses/strains at Gauss points. These stresses/strains are specified in the same manner as TSSIE and TSSIA.
Temperatures	TEMP, TMPE	Temperatures at nodes/for element. T, 0, dT/dy, dT/dz, To, 0, dTo/dy, dTo/dz in local directions
Overburden	Not applicable.	
Phreatic Surface	Not applicable.	
Field Loads	Not applicable.	
Temp Dependent Loads	Not applicable.	

LUSAS Output

Solver Force (default): Fx, Fy, Fz, Mx, My, Mz, Fb, Mb: axial force, shear forces, torque, moments, bishear (or warping torsion) and bimoment in local directions.
 Strain: ϵ_x , ϵ_y , ϵ_z , ψ_x , ψ_y , ψ_z , α , α' : axial, shear, torsional,

flexural strains and torsional warping strains in local directions. By default element output is with respect to the nodal line. Option 380 outputs stress/strain resultants with respect to the beam centreline.

Modeller See [Results Tables \(Appendix K\)](#).

Local Axes

- ❑ **Standard line element** For each element/active node, the local xy-plane is defined by the local x-axis and the orientation node. The local y-axis is perpendicular to the local x-axis and positive on the side of the element where the orientation node lies. The local y and z-axes form a right-handed set with the local x-axis. See [Local Element Axes](#) for details

Sign Convention

- ❑ **Standard beam element**

Formulation

Geometric Nonlinearity

Total Lagrangian	For large displacements, large rotations and small strains (see Notes).
Updated Lagrangian	Not applicable.
Eulerian	Not applicable.
Co-rotational	For large displacements, large rotations and small strains.
P-Delta	Displacements and rotations should be small (see Notes)

Integration Schemes

Stiffness	Default.	1-point (BMI21W and BMI22W), 2-point (BMI31W and BMI33W).
	Fine.	Same as default.
Mass	Default.	2-point (BMI21W and BMI22W), 3-point (BMI31W and BMI33W).
	Fine.	Same as default.

Note: A 3-point [Newton-Cotes integration](#) rule is also available for BMI31W and BMI33W using option 134. This may be more applicable for infinitesimal strain, elastoplastic analyses of plane frames with straight members since the first and third quadrature points will coincide with the frame joints. See Appendix I of the Theory Manual

Mass Modelling

- Consistent mass (default).
- Lumped mass.

Options

- 36 Follower loads
- 55 Output strains as well as stresses.
- 87 Total Lagrangian geometric nonlinearity (see Notes).
- 102 Switch off load correction stiffness matrix due to centripetal acceleration
- 105 Lumped mass matrix.
- 134 Gauss to [Newton-Cotes](#) in plane (in the local x direction) integration for elements
- 157 Material model 29 (non cross-section elements), see Notes.
- 229 Co-rotational geometric nonlinearity.
- 380 Output stress/strain resultants relative to beam axes for eccentric elements.
- 403 Introduce residual bending flexibility correction for 2-node thick beam BMI21, see Notes, Assumptions and Limitations.
- 404 Compute equivalent nodal loading from equilibrium considerations for 2-node thick beam BMI21, see Notes, Assumptions and Limitations.
- 405 Specify geometric properties along beam centroidal axes
- 406 Specify CBF, UDL, SSI, SSR and TEMP loads along beam centroidal axes
- 421 P-Delta analysis, see Notes
- 424 Include the Wagner effect in the large deformation formulation for beams
- 432 Use P-Delta geometric stiffness matrix of thick beams for linear buckling analysis

Notes, Assumptions and Limitations

1. The element is formulated from the so-called degenerate continuum concept, i.e. enforcing directly the modified Timoshenko hypothesis for thick beams to the continuum theory. Shearing deformations and torsional warping are included.
2. By default input of geometric properties and loads, and output of element stress/strain resultants are with respect to the nodal line. Option 405 inputs geometric properties, option 406 inputs loads, and option 380 outputs stress/strain resultants with respect to the beam centreline. CL is always input with respect to the nodal line; displacements are output with respect to the nodal line.
3. When OPTION 403 is specified to introduce residual bending flexibility correction (on by default), for BMI21W and BMI22W, the axial force, bishear, bimoment and torsion are constant, while the other shear forces and moments

vary linearly along the length of the beam. For BMI31W and BMI33W the axial force, all shear forces, all moments and torsion vary linearly along the length

4. When BMI21W is used together with OPTION 403 to introduce residual bending flexibility correction, its stiffness matrix is enhanced to the order of a cubic.
5. When BMI21W is used together with OPTION 404, loading that varies along the element length is accounted for in the force diagrams (i.e. for a beam under CBF or internal element loading). Internal forces and moments are output at intervals of 1/10th of the element length by specifying the Gauss point option from the Output button of the LUSAS Datafile dialog.
6. The end releases for this element allow a joint to be modelled between adjacent elements. These joints allow rotation and translation of one beam with respect to another without load transferral as well as different warping conditions in adjacent elements. The rotations and translations remain in the local directions of the beam elements and support large deformations.
7. The [rigidity matrix](#) is evaluated explicitly from the geometric properties for both linear and nonlinear materials.
8. Option 36 is only applicable for use with element load types ELDS and UDL. Specifying this option makes these element loads follow the element geometry as the analysis progresses.
9. For large deformation analyses the following geometric properties (Wagner constants) are required (see Geometric Properties) if Option 424 = T: Iyr, Igr, Irr and Iwr at each node. If these constants are set to zero, the Wagner effect will be ignored, and the results may not be correct if twist rotations are not small.
10. When a step by step dynamic analysis is carried out using BMI elements with distributed loading, the "free body force diagrams" pertaining to applied loading, are not superimposed on the nodal values, to do so would lead to erroneous results until a steady state is reached. It should therefore be noted that different force diagrams will be obtained for BMI elements if static and dynamic analyses are directly compared.
11. OPTION 229 considers large displacements and large rotations using a co-rotational formulation. When both options 87 and 229 are true, a local Total Lagrangian formulation will be used within a global co-rotational framework. Note that OPTION 87 has no effect when specified without OPTION 229.
12. Stiffness and mass factors allow different geometric properties to be used in the calculation of the stiffness and mass matrices. Stiffness factors are also used in the processing of stress and strains loads whilst the mass factors are used in the processing of body forces loads. The values are input after all geometric

3D Thick Beam Elements with Quadrilateral Cross-Section and Torsional Warping

General

Element Name

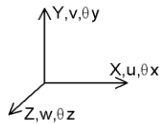

BMX21W

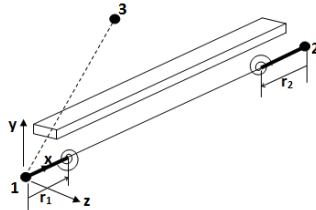

BMX22W

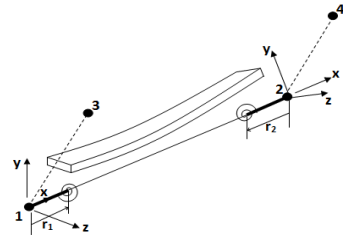

BMX31W

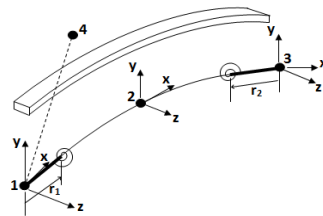

BMX33W

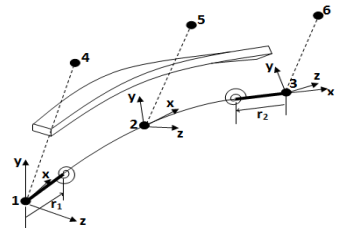

Element Group

Beams

Element Subgroup

Isoparametric Degenerate Beams

Element Description

Straight and curved isoparametric degenerate beam elements in 3D for which shearing deformations and torsional warping are included. The element has a quadrilateral cross section which may vary along the element length. BMX22W and BMX33W can consider initial twisting.

Number of Nodes

3(BMX21W), 4 (BMX22W and BMX31W) and 6(BMX33W) with end release conditions. The orientation node(s) (3rd node of BMX21W, 3rd and 4th nodes of BMX22W, 4th node of BMX31W, 4th, 5th and 6th nodes of BMX33W) are used to define the local xy-plane.

Freedom

U, V, W, θ_x , θ_y , θ_z : at each active node.

End Releases

The element node numbers should be followed by: R restrained (default), F free defined in the order U, V, W, θ_x , θ_y , θ_z at node 1 and then U, V, W, θ_x , θ_y , θ_z at node 2 and node 3 (only for BMX31 and BMX33) related to local element axes (see Notes).

Partial Fixity	<p>The element node numbers should be followed by: R restrained (or continuous or unreleased) (default), F free (or discontinuous or released), C discontinuous and constrained, defined in the order U, V, W, θ_x, θ_y, θ_z, α and then U, V, W, θ_x, θ_y, θ_z, α at node 2 and node 3 (only for BMX31W and BMX33W) related to local element axes (see Notes).</p> <p>Partial fixity at each end node can be defined for all freedoms; this can take the form of a fixity reduction factor or an explicitly defined stiffness value. Partial fixities are defined with respect to the local element axes (see Notes, Assumptions and Limitations).</p>
End Conditions	<p>Rigid lengths r_1 and r_2 measured from each end node can be specified for these elements. If these lengths are non zero then any end release or partial fixity is applied at the inner point defining the rigid end. A rigidity factor ($1.0 > \lambda > 0.0$) can be specified to make the ends semi-rigid, and options to include/exclude the masses of the rigid ends are also provided (see Notes, Assumptions and Limitations).</p>
Node Coordinates	<p>X, Y, Z: at each node.</p>

Geometric Properties

$y_1, z_1, y_2, z_2, y_3, z_3, y_4, z_4$: local cross section coordinate pairs for a triangle at each node; followed by $nt12, nt14$: specifying the number of integration points $nt12 * nt14$ (the value $nt12 * nt14$ determines the integration rule no matter what the values $nt12$ and $nt14$ are except when $nt12 * nt14 = 7$, $nt12 = 1$ defines a cubic rule, while $nt12 = 7$ defines a quintic rule)

or

$y_1, z_1, y_2, z_2, y_3, z_3, y_4, z_4$: local cross section coordinate pairs for a quadrilateral at each node; followed by $nt12, nt14$: specifying the number of Newton-Cotes integration points in the direction defined by the local cross-section points 1-2 and 1-4 (zero indicates default values). Multiple quadrilateral cross-sections can be used to build up complex beam cross-sections. Number of divisions for each coarse quadrilateral (default =5) can be specified for the computation of warping of cross-section

Note. The corners of the quadrilateral are numbered clockwise about the local x-axis (the beam nodal line), that is, a right-hand screw rule in the direction of increasing x.

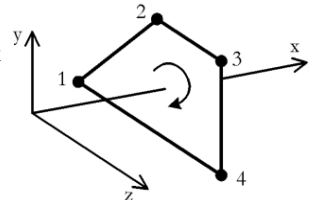

Material Properties

Linear	Isotropic:	MATERIAL PROPERTIES (Elastic: Isotropic)
Matrix	Not applicable	
Joint	Not applicable	
Concrete		MATERIAL PROPERTIES NONLINEAR 109 (Elastic: Isotropic, Plastic: Smoothed Multi Crack Concrete)
Elasto-Plastic	Stress resultant: Tresca:	Not applicable. MATERIAL PROPERTIES NONLINEAR 61 (Elastic: Isotropic, Plastic: Tresca, Hardening: Isotropic Hardening Gradient, Isotropic Plastic Strain or Isotropic Total Strain)
	Drucker-Prager:	MATERIAL PROPERTIES NONLINEAR 64 (Elastic: Isotropic, Plastic: Drucker-Prager, Hardening: Granular)
	Mohr-Coulomb:	MATERIAL PROPERTIES NONLINEAR 65 (Elastic: Isotropic, Plastic: Mohr-Coulomb, Hardening: Granular with Dilation)
	Optimised Implicit Von Mises:	MATERIAL PROPERTIES NONLINEAR 75 (Elastic: Isotropic, Plastic: Von Mises, Hardening: Isotropic & Kinematic)
	Volumetric Crushing:	Not applicable.
	Stress Potential	STRESS POTENTIAL VON_MISES (Isotropic: von Mises, Modified von Mises)
Creep		CREEP PROPERTIES (Creep)
	AASHTO	MATERIAL PROPERTIES NONLINEAR 86 AASHTO (Concrete creep model to AASHTO code of Practice)
	CEB-FIP	MATERIAL PROPERTIES NONLINEAR 86 CEB-FIP (Concrete creep model to CEB-FIP Model Code 1990)
	Chinese	MATERIAL PROPERTIES NONLINEAR 86 CHINESE (Chinese creep model to Chinese Code of Practice)

	Eurocode	MATERIAL PROPERTIES NONLINEAR 86 EUROCODE (Concrete creep model to EUROCODE_2)
	IRC	MATERIAL PROPERTIES NONLINEAR 86 IRC (Concrete creep model to Indian IRC code of Practice)
Damage		DAMAGE PROPERTIES SIMO, OLIVER (Damage)
Viscoelastic Shrinkage	Not applicable	SHRINKAGE CEB_FIP_90, EUROCODE_2, GENERAL, USER
Rubber	Not applicable	
Generic Polymer	Not applicable	
Composite	Not applicable	

Loading

Prescribed Value	PDSP, TPDSP	Prescribed variable. U, V, W, θ_x , θ_y , θ_z : at active nodes.
Concentrated Loads	CL	Concentrated loads in global directions. Px, Py, Pz, Mx, My, Mz, α : at active nodes (global).
Element Loads	ELDS	Element loads on nodal line (load type number LTYPE *10 defines the corresponding element load type on beam axis, see Notes, Assumptions and Limitations) LTYPE, S1, Px, Py, Pz, Mx, My, Mz LTYPE=11: point loads and moments in local directions. LTYPE=12: point loads and moments in global directions. LTYPE, 0, Wx, Wy, Wz, Mx, My, Mz LTYPE=21: uniformly distributed loads in local directions. LTYPE=22: uniformly distributed loads in global directions (Mx=0). LTYPE=23: uniformly distributed projected loads in global directions.

		LTYPE, S1, Wx1, Wy1, Wz1, Mx1, My1, Mz1, S2, Wx2, Wy2, Wz2, Mx2, My2, Mz2
		LTYPE=31: distributed loads in local directions.
		LTYPE=32: distributed loads in global directions.
		LTYPE=33: distributed projected loads in global directions.
		LTYPE, S1, Wx, Wy, Wz, Mx, My, Mz
		LTYPE=41: trapezoidal loads in local directions.
		LTYPE=42: trapezoidal loads in global directions.
		LTYPE=43: trapezoidal projected loads in global directions.
	DLDL, DLDG	Not applicable.
	DLEL, DLEG	Not applicable.
	PLDL, PLDG	Not applicable.
Distributed Loads	UDL	Uniformly distributed loads. Wx, Wy, Wz, Mx, My, Mz: local forces and moments / unit length for element in local directions. see Notes, Assumptions and Limitations.
	FLD, FLDG	Not applicable.
Body Forces	CBF	Constant body forces for Element. Xcbf, Ycbf, Zcbf, Ω_x , Ω_y , Ω_z , α_x , α_y , α_z
	BFP, BFPE	Body force potentials at nodes/for element. ϕ_1 , ϕ_2 , ϕ_3 , 0, Xcbf, Ycbf, Zcbf
Velocities	VELO	Velocities. Vx, Vy, Vz: at nodes.
Accelerations	ACCE	Acceleration. Ax, Ay, Az: at nodes
Viscous Support Loads	VSL	Viscous support loads. VLx, VLy, VLz: at nodes.
Initial Stress/Strains	SSI, SSIE	Initial stresses/strains at nodes/for element. Components: Fx, Fy, Fz, Mx, My, Mz, 0, 0, ϵ_x , ϵ_y , ϵ_z , ψ_x , ψ_y , ψ_z , 0, 0, (σ_x , σ_{xy} , σ_{xz} , ϵ_x , ϵ_{xy} , ϵ_{xz}) Bracketed terms repeated for each fibre integration point.
	SSIG	Initial stresses/strains at Gauss points.

Modeller See Results Tables (Appendix K).

Local Axes

- [Standard line element](#) For each element/active node, the local xy-plane is defined by the local x-axis and the orientation node. The local y-axis is perpendicular to the local x-axis and positive on the side of the element where the orientation node lies. The local y and z-axes form a right-handed set with the local x-axis. See [Local Element Axes](#) for details

Sign Convention

- [Standard beam element](#)

Formulation

Geometric Nonlinearity

Total Lagrangian	For large displacements and large rotations (see Notes).
Updated Lagrangian	Not applicable.
Eulerian	Not applicable.
Co-rotational	For large displacements and large rotations.
P-Delta	Displacements and rotations should be small (see Notes)

Integration Schemes

Stiffness	Default.	1-point (BMX21W and BMX22W), 2-point (BMX31W and BMX33W).
	Fine.	Same as default.
Mass	Default.	2-point (BMX21W and BMX22W), 3-point (BMX31W and BMX33W).
	Fine.	Same as default.

Note: A 3-point [Newton-Cotes integration](#) rule is also available for BMX31W and BMX33W using option 134. This may be more applicable for infinitesimal strain, elastoplastic analyses of plane frames with straight members since the first and third quadrature points will coincide with the frame joints. See Appendix I of the Theory manual.

Mass Modelling

- Consistent mass (default).
- Lumped mass.

Options

- 36 Follower loads
- 55 Output strains as well as stresses.
- 87 Total Lagrangian geometric nonlinearity (see Notes)
- 102 Switch off load correction stiffness matrix due to centripetal acceleration
- 105 Lumped mass matrix.
- 134 Gauss to [Newton-Cotes](#) in plane (in the local x direction) integration for elements.
- 139 Output yielded integration points only.
- 172 Form the [rigidity matrix](#) by numerical cross section integration.
- 229 Co-rotational geometric nonlinearity.
- 380 Output stress/strain resultants relative to beam axes for eccentric elements
- 403 Introduce residual bending flexibility correction for 2-node thick beam BMI21, see Notes, Assumptions and Limitations (on by default).
- 404 Compute equivalent nodal loading from equilibrium considerations for 2-node thick beam BMX21, see Notes (on by default).
- 405 Specify geometric properties along beam centroidal axes.
- 406 Specify CBF, UDL, SSI, SSR and TEMP loads along beam centroidal axes
- 418 Output stress resultants relative to beam centroidal axes for eccentric elements
- 421 P-Delta analysis, see Notes
- 432 Use P-Delta geometric stiffness matrix of thick beams for linear buckling analysis

Notes, Assumptions and Limitations

1. The element is formulated from the so-called degenerate continuum concept, i.e. enforcing directly the modified Timoshenko hypothesis for thick beams to the continuum theory. Shearing deformations and torsional warping are included.
2. By default input of loads and output of element stress/strain resultants are with respect to the nodal line. Option 381 inputs loads, and option 380 outputs stress/strain resultants with respect to the beam centreline. CL is always input with respect to the nodal line; displacements are output with respect to the nodal line.
3. When OPTION 403 is specified to introduce residual bending flexibility correction (on by default), for BMX21W and BMX22W, the axial force, torsion, bi-shear and bi-moment are constant, while the other shear forces and moments vary linearly along the length of the beam. For BMX31W and BMX33W the axial force, all shear forces, all moments and the torsion vary linearly along the length.

4. When BMX21W is used together with OPTION 403 to introduce residual bending flexibility correction, its stiffness matrix is enhanced to the order of a cubic. Note that if OPTION 403 is used with eccentrically stacked elements, slippage can occur.
5. The end releases for this element allow a joint to be modelled between adjacent elements. These joints allow rotation and translation of one beam with respect to another without load transferral as well as different warping conditions in adjacent elements. The rotations and translations remain in the local directions of the beam elements and support large deformations.
6. Computation of the [rigidity matrix](#) by integration through the cross-section depth of the beam is necessary for all linear and nonlinear material models. By default OPTION 172 is invoked automatically and a 3*3 and 5*5 point [Newton-Cotes integration](#) rule is used respectively for linear and nonlinear materials for quadrilaterals; and a 7 point cubic rule is used for both linear and nonlinear materials for triangles. This allows the output of stresses at the numerical cross section integration points.
7. OPTION 36 is only applicable for use with element load types ELDS and UDL. Specifying this option makes these element loads follow the element geometry as the analysis progresses.
8. For large deformation analyses the following geometric properties (Wagner constants) are required (see Geometric Properties) if Option 424 = T: Iyr, Igr, Irr and Iwr at each node. If these constants are set to zero, the Wagner effect will be ignored, and the results may not be correct if twist rotations are not small.
9. When a step by step dynamic analysis is carried out using BMI elements with distributed loading, the "free body force diagrams" pertaining to applied loading, are not superimposed on the nodal values, to do so would lead to erroneous results until a steady state is reached. It should therefore be noted that different force diagrams will be obtained for BMI elements if static and dynamic analyses are directly compared.
10. OPTION 229 considers large displacements and large rotations using a co-rotational formulation. When both options 87 and 229 are true, a local Total Lagrangian formulation will be used within a global co-rotational framework. Note that OPTION 87 has no effect when specified without OPTION 229.
11. Stiffness and mass factors allow different geometric properties to be used in the calculation of the stiffness and mass matrices. Stiffness factors are also used in the processing of stress and strains loads whilst the mass factors are used in the processing of body forces loads. The values are input after all geometric properties and the keyword MODIFICATION_FACTORS must be added to the GEOMETRIC PROPERTIES input command.

2D Kirchhoff Thin Beam Elements

General

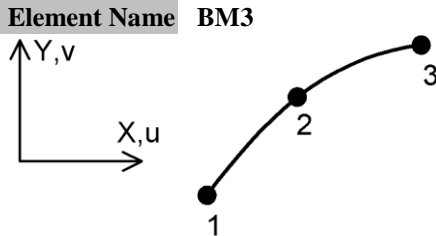

Element Group	Beams
Element Subgroup	Kirchhoff Beams
Element Description	Parabolically curved thin beam element in which shear deformations are excluded. The element can accommodate varying geometric properties along the length.
Number Of Nodes	3
Freedoms	U, V, θ_z : at end nodes. dU: (relative displacement) at mid-side node.
Node Coordinates	X, Y: at each node.

Geometric Properties

- A, Izz, ey** At each node
- SF1,SF2,SF3** Optional scale factors applied to the geometric properties in the calculation of the stiffness and mass matrices
- MF1,MF2,MF3** Optional scale factors applied to the geometric properties in the calculation of the stiffness and mass matrices
- A** Cross sectional area
- Izz** 2nd moment of area about local z-axis (see [Definition](#)).
- ey** Eccentricity from beam xz-plane to nodal line (+ve in +ve local y-direction)

For a beam with [eccentricity](#) e from the nodal line then $I_{zz}=e^2A+I_{na}$ and $I_z=eA$ ($I_{na}=I$ about centroidal axis).

For MATERIAL MODEL 29 additional geometric properties are appended to the previous 9 geometric properties; see *Notes*.

Material Properties

- Linear ..** Isotropic: MATERIAL PROPERTIES (Elastic: Isotropic)
- Rigidities: RIGIDITIES 3 (Rigidities:Beam)

Matrix	Not applicable	
Joint	Not applicable	
Concrete	Not applicable	
Elasto-Plastic	Stress resultant:	MATERIAL PROPERTIES NONLINEAR 29 (Elastic: Isotropic, Plastic: Resultant) (ifcode=1 or 2, see <i>Notes</i>)
Creep		CREEP PROPERTIES (Creep)
	AASHTO	MATERIAL PROPERTIES NONLINEAR 86 AASHTO (Concrete creep model to AASHTO code of Practice)
	CEB-FIP	MATERIAL PROPERTIES NONLINEAR 86 CEB-FIP (Concrete creep model to CEB-FIP Model Code 1990)
	Chinese	MATERIAL PROPERTIES NONLINEAR 86 CHINESE (Chinese creep model to Chinese Code of Practice)
	Eurocode	MATERIAL PROPERTIES NONLINEAR 86 EUROCODE (Concrete creep model to EUROCODE_2)
	IRC	MATERIAL PROPERTIES NONLINEAR 86 IRC (Concrete creep model to Indian IRC code of Practice)
Damage	Not applicable	
Viscoelastic	Not applicable	
Shrinkage		SHRINKAGE CEB_FIP_90, EUROCODE_2, GENERAL, USER
Rubber	Not applicable	
Generic Polymer	Not applicable	
Composite	Not applicable	

Loading

Prescribed Value	PDSP, TPDSP	Prescribed variable. U, V, θ_z : at end nodes.
Concentrated Loads	CL	Concentrated loads. Px, Py, Mz: at end nodes. dPx: in local x direction at mid-side node.
Element Loads	ELDS	<p>Element loads on nodal line (load type number LTYPE *10 defines the corresponding element load type on beam axis).</p> <p>LTYPE, S1, Px, Py, Mz LTYPE=11: point loads and moments in local directions. LTYPE=12: point loads and moments in global directions. LTYPE, 0, Wx, Wy, Mz LTYPE=21: uniformly distributed loads in local directions. LTYPE=22: uniformly distributed loads in global directions. LTYPE=23: uniformly distributed projected loads in global directions LTYPE, S1, Wx1, Wy1, Mz1, S2, Wx2, Wy2, Mz2 LTYPE=31: distributed loads in local directions. LTYPE=32: distributed loads in global directions. LTYPE=33: distributed projected loads in global directions LTYPE, S1, Wx, Wy, Mz LTYPE=41: trapezoidal loads in local directions. LTYPE=42: trapezoidal loads in global directions. LTYPE=43: trapezoidal projected loads in global directions</p>
Distributed Loads	UDL	Uniformly distributed loads. Wx, Wy: force/unit length in local directions.
	FLD, FLDG	Not applicable.
Body Forces	CBF	Constant body forces for element. Xcbf, Ycbf, Ω_x , Ω_y , Ω_z , α_z
	BFP, BFPE	Body force potentials at nodes/for element. φ_1 , φ_2 , 0, 0, Xcbf, Ycbf

Velocities	VELO	Velocities. V_x, V_y : at nodes.
Viscous Support Loads	VSL	Viscous support loads. VL_x, VL_y : at nodes.
Accelerations	ACCE	Acceleration A_x, A_y : at nodes
Initial Stress/Strains	SSI, SSIE	Initial stresses/strains at nodes/for element. $F_x, M_z, 0$: forces, moments in local directions. $\epsilon_x, \psi_z, 0$: strains in local directions.
	SSIG	Initial stresses/strains at Gauss points $F_x, M_z, 0$: forces, moments in local directions. $\epsilon_x, \psi_z, 0$: strains in local directions.
Residual Stresses	SSR, SSRE	Residual stresses at nodes/for element. $F_x, M_z, 0$: forces, moments in local directions.
	SSRG	Residual stresses at Gauss points $F_x, M_z, 0$: forces, moments in local directions.
Temperatures	TEMP, TMPE	Temperatures at nodes/for element. $T, 0, dT/dy, 0, T_0, 0, dT_0/dy, 0$
Target Stress/Strains	TSSIE, TSSIA	Target stresses/strains at nodes/for element. $F_x, M_z, 0$: forces, moments in local directions. $\epsilon_x, \psi_z, 0$: strains in local directions.
	TSSIG	Target stresses/strains at Gauss points $F_x, M_z, 0$: forces, moments in local directions. $\epsilon_x, \psi_z, 0$: strains in local directions.
Overburden	Not applicable.	
Phreatic Surface	Not applicable.	
Field Loads	Not applicable.	
Temp Dependent Loads	Not applicable.	

LUSAS Output

Solver	Force (default): F_x, F_y, M_z : forces, moments in local directions (see <i>Notes</i>). Strain: $\epsilon_x, \epsilon_y, \psi_z$: axial, flexural strains in local directions. By default element output is with respect to the nodal line. OPTION 418 outputs stress/strain resultants with respect to the beam centroidal axis.
Modeller	See Results Tables (Appendix K) .

Local Axes

- [Standard line element](#)

Sign Convention

- [Standard beam element](#)

Formulation

Geometric Nonlinearity

Total Lagrangian	For large displacements, small rotations and small strains.
Updated Lagrangian	For large displacements, large rotations and small strains.
Eulerian	Not applicable.
Co-rotational	Not applicable.

Integration Schemes

Stiffness	Default.	2-point.
	Fine (see <i>Options</i>).	3-point.
Mass	Default.	2-point.
	Fine (see <i>Options</i>).	3-point.

A 3-point [Newton-Cotes integration](#) rule is also available using option 134. This may be more applicable for infinitesimal strain, elastoplastic analyses of plane frames with straight members since the first and third quadrature points will coincide with the frame joints. See Appendix I of the Theory manual.

Mass Modelling

- Consistent mass (default).
- Lumped mass.

Options

- 18** Invokes fine integration rule for element.
- 54** Updated Lagrangian geometric nonlinearity.
- 55** Output strains as well as stresses.
- 87** Total Lagrangian geometric nonlinearity.
- 105** Lumped mass matrix
- 134** Gauss to [Newton-Cotes](#) in plane (in the local x direction) integration for elements.
- 157** Material model 29 (non cross-section elements), see *Notes*.

- 170 Suppress transfer of shape function arrays to disk.
- 405 Specify geometric properties along beam centroidal axes
- 406 Specify CBF, UDL, SSI, SSR and TEMP loads along beam centroidal axes.
- 418 Output stress resultants relative to beam centroidal axes for eccentric elements

Notes on Use

1. The element formulation is based on the constrained super-parametric approach. The variation of axial force along the beam is linear. The variation of displacement is quadratic in the local x-direction and cubic in the local y-direction. Shear force is constant.
2. Input of geometric properties (OPTION 405) and loads (OPTION 406), and output of stress/strain resultants (OPTION 418) are with respect to the beam centroidal axis. CL is always input with respect to the nodal line; displacements are output with respect to the nodal line
3. For nonlinear material model 29 the following geometric properties are appended to those already specified (see *Geometric Properties*).
 - A^P , Zzz^P , S^P at each node (i.e. nodes 1, 2, 3)
 - A^P Plastic area (=elastic area)
 - Zzz^P Plastic modulus for bending about z axis
 - S^P Plastic area for shear ($S^P=0$)
4. For nonlinear material model 29 the following ifcode parameters should be
 - ifcode=1 for circular hollow sections.
 - ifcode=2 for solid rectangular sections.
5. Temperature dependent properties cannot be used with material model 29.
6. The element should not be coupled to the face of a two dimensional continuum element because of the midside node incompatibility.
7. The **rigidity matrix** for BM3 is evaluated explicitly from the material and geometric properties for both linear and nonlinear materials.
8. Stiffness and mass factors allow different geometric properties to be used in the calculation of the stiffness and mass matrices. Stiffness factors are also used in the processing of stress and strains loads whilst the mass factors are used in the processing of body forces loads. The values are input after all geometric properties and the keyword MODIFICATION_FACTORS must be added to the GEOMETRIC PROPERTIES input command

Restrictions

- ❑ [Ensure mid-side node centrality](#)
- ❑ Avoid excessive element curvature

Recommendations on Use

The element may be used for linear and nonlinear analysis of two dimensional beam, frame and arch structures. The 2-noded straight beam (BMI2 is more effective for the linear analysis of structures containing straight members of constant cross-section, e.g. plane frames.

2D Kirchhoff Thin Beam Element with Quadrilateral Cross-Section

General

Element Name BMX3

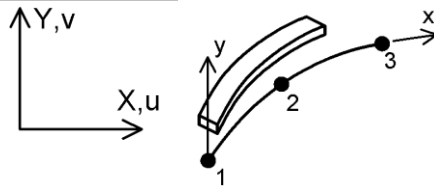

Element Group Beams

Element Subgroup [Kirchhoff](#) Beams

Element Description Parabolically curved thin beam elements in which shear deformations are excluded. The quadrilateral cross-section may be eccentric and can vary along the element length.

Number Of Nodes 3

Freedom U, V, θ_z : at end nodes.
dU: (relative displacement) at mid-side node.

Node Coordinates X, Y: at each node.

Geometric Properties

$y_1, z_1, y_2, z_2, y_3, z_3, y_4, z_4$: local cross section coordinate pairs at each node; followed by nt_{12}, nt_{14} : specifying the number of [Newton-Cotes integration](#) points in the direction defined by the local cross-section points 1-2 and 1-4 (zero indicates default values). See *Notes*. Multiple quadrilateral cross-sections can be used to build up complex beam cross-sections.

Note. The coordinates of the cross section are numbered clockwise about the local x-axis (the beam nodal line). That is, a right-hand screw rule in the direction of increasing x.

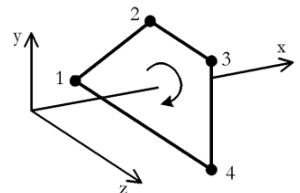

Material Properties

Linear	Isotropic:	MATERIAL PROPERTIES (Elastic: Isotropic)	
Matrix	Not applicable		
Joint	Not applicable		
Concrete	Not applicable		
Elasto-Plastic	Stress resultant:	MATERIAL PROPERTIES NONLINEAR 29 (Elastic: Isotropic, Plastic: Resultant) (ifcode=2, see <i>Notes</i>)	
	Tresca:	MATERIAL PROPERTIES NONLINEAR 61 (Elastic: Isotropic, Plastic: Tresca, Hardening: Isotropic Hardening Gradient, Isotropic Plastic Strain or Isotropic Total Strain)	
	Drucker-Prager:	MATERIAL PROPERTIES NONLINEAR 64 (Elastic: Isotropic, Plastic: Drucker-Prager, Hardening: Granular)	
	Mohr-Coulomb:	MATERIAL PROPERTIES NONLINEAR 65 (Elastic: Isotropic, Plastic: Mohr-Coulomb, Hardening: Granular with Dilation)	
	Optimised Implicit Von Mises:	MATERIAL PROPERTIES NONLINEAR 75 (Elastic: Isotropic, Plastic: Von Mises, Hardening: Isotropic & Kinematic)	
	Volumetric Crushing:	Not applicable	
	Stress Potential	STRESS POTENTIAL VON_MISES (Isotropic: von Mises, Modified von Mises)	
	Creep		CREEP PROPERTIES (Creep)
		AASHTO	MATERIAL PROPERTIES NONLINEAR 86 AASHTO (Concrete creep model to AASHTO code of Practice)
		CEB-FIP	MATERIAL PROPERTIES NONLINEAR 86 CEB-FIP (Concrete creep model to CEB-FIP Model Code 1990)
Chinese		MATERIAL PROPERTIES NONLINEAR 86 CHINESE (Chinese creep model to Chinese Code of Practice)	
Eurocode		MATERIAL PROPERTIES NONLINEAR 86 EUROCODE (Concrete creep model to EUROCODE_2)	

	IRC	MATERIAL PROPERTIES NONLINEAR 86 IRC (Concrete creep model to Indian IRC code of Practice)
Damage		DAMAGE PROPERTIES SIMO, OLIVER (Damage)
Viscoelastic Shrinkage	Not applicable	SHRINKAGE CEB_FIP_90, EUROCODE_2, GENERAL, USER
Rubber	Not applicable	
Generic Polymer	Not applicable	
Composite	Not applicable	

Loading

Prescribed Value	PDSP, TPDSP	Prescribed variable. U, V, θ_z : at end nodes. dU at mid-side node.
Concentrated Loads	CL	Concentrated loads. Px, Py, Mz: at end nodes (global). dPx: at mid-side node (local).
Element Loads	ELDS	Element loads on nodal line (load type number LTYPE *10 defines the corresponding element load type on beam axis). LTYPE, S1, Px, Py, Mz LTYPE=11: point loads and moments in local directions. LTYPE=12: point loads and moments in global directions. LTYPE, 0, Wx, Wy, Mz LTYPE=21: uniformly distributed loads in local directions. LTYPE=22: uniformly distributed loads in global directions. LTYPE=23: uniformly distributed projected loads in global directions LTYPE, S1, Wx1, Wy1, Mz1, S2, Wx2, Wy2, Mz2 LTYPE=31: distributed loads in local directions. LTYPE=32: distributed loads in global directions. LTYPE=33: distributed projected loads in global directions LTYPE, S1, Wx, Wy, Mz LTYPE=41: trapezoidal loads in local

		directions.
		LTYPE=42: trapezoidal loads in global directions.
		LTYPE=43: trapezoidal projected loads in global directions
Distributed Loads	UDL	Uniformly distributed loads. W_x, W_y : force/unit length in local directions.
	FLD, FLDG	Not applicable.
Body Forces	CBF	Constant body forces for element. $X_{cbf}, Y_{cbf}, \Omega_x, \Omega_y, \Omega_z, \alpha_z$
	BFP, BFPE	Body force potentials at nodes/for element. $\phi_1, \phi_2, 0, 0, X_{cbf}, Y_{cbf}$
Velocities	VELO	Velocities. V_x, V_y : at nodes.
Accelerations	ACCE	Acceleration A_x, A_y : at nodes
Viscous Support Loads	VSL	Viscous support loads. V_{Lx}, V_{Ly} : at nodes.
Initial Stress/Strains	SSI, SSIE	Initial stresses/strains at nodes/for element. Resultants (for linear material models without numerical cross section integration and model 29, see <i>Notes</i>): $F_x, M_z, 0$: forces, moments in local directions. $\epsilon_x, \psi_z, 0$: strains in local directions.
	SSIG	Initial stresses/strains at Gauss points. (1) Resultants (for linear material models without numerical cross section integration and model 29, see <i>Notes</i>). $F_x, M_z, 0$: forces, moments in local directions. $\epsilon_x, \psi_z, 0$ strains in local directions. (2) Components (for linear material models with numerical cross section integration and all non-linear material models except 29): $F_x, M_z, 0, \epsilon_x, \psi_z, 0, (\sigma_x, \epsilon_x)$. Bracketed terms repeated at each fibre integration point.
Residual Stresses	SSR, SSRE SSRG	Not applicable. Residual stresses at Gauss points. (1) Resultants (material model 29): $F_x, M_z, 0$ (2) Components (all nonlinear material models except 29, also linear material models with numerical cross section integration): $0, 0, 0, 0, 0, 0, (\sigma_x, \epsilon_x)$ Bracketed term repeated for each fibre integration point.
Target	TSSIE,	Target stresses/strains at nodes/for element.

Stress/Strains	TSSIA	Resultants (for linear material models without numerical cross section integration and model 29, see <i>Notes</i>): F_x , M_z , 0: forces, moments in local directions. ϵ_x , ψ_z , 0: strains in local directions.
	TSSIG	Target stresses/strains at Gauss points. (1) Resultants (for linear material models without numerical cross section integration and model 29, see <i>Notes</i>). F_x , M_z , 0: forces, moments in local directions. ϵ_x , ψ_z , 0 strains in local directions. (2) Components (for linear material models with numerical cross section integration and all non-linear material models except 29): F_x , M_z , 0, ϵ_x , ψ_z , 0, (σ_x, ϵ_x) . Bracketed terms repeated at each fibre integration point.
Temperatures	TEMP, TMPE	Temperatures at nodes/for element T, 0, dT/dy , 0, T_0 , 0, dT_0/dy , 0: in local directions.
Overburden	Not applicable.	
Phreatic Surface	Not applicable.	
Field Loads	Not applicable.	
Temp Dependent Loads	Not applicable.	

LUSAS Output

Solver	Force (default): F_x , M_z , F_y : forces, moment in local directions (see <i>Notes</i>) Continuum stresses (OPTION 172): σ_x : in local directions. Strain: ϵ_x , ψ_z , 0 : axial, flexural strains in local directions. Continuum strains (OPTION 172): ϵ_x : in local directions. By default element output is with respect to the nodal line. OPTION 418 outputs stress/strain resultants with respect to the beam centroidal axis.
Modeller	See Results Tables (Appendix K) .

Local Axes

- Standard line element

Sign Convention

- [Standard beam element](#)

Formulation

Geometric Nonlinearity

Total Lagrangian	For large displacements, small rotations and small strains.
Updated Lagrangian	For large displacements, large rotations and small strains.
Eulerian	Not applicable.
Co-rotational	Not applicable.

Integration Schemes

Stiffness	Default.	2-point.
	Fine (see <i>Options</i>).	3-point.
Mass	Default.	2-point.
	Fine (see <i>Options</i>).	3-point.

A 3-point [Newton-Cotes integration](#) rule is also available using option 134. This may be more applicable for infinitesimal strain, elastoplastic analyses of plane frames with straight members since the first and third quadrature points will coincide with the frame joints. See Appendix I of the Theory manual.

Mass Modelling

- Consistent mass (default).
- Lumped mass.

Options

- 18** Invokes fine integration rule for element.
- 32** Suppress stress output but not resultants
- 54** Updated Lagrangian geometric nonlinearity.
- 55** Output strains as well as stresses
- 87** Total Lagrangian geometric nonlinearity
- 105** Lumped mass matrix
- 134** Gauss to [Newton-Cotes](#) in plane (in the local x direction) integration for elements.
- 157** Material model 29 (non cross-section elements), see *Notes*.
- 170** Suppress transfer of shape function arrays to disk.
- 172** Formulate [rigidity matrix](#) by integrating across the cross-section

406 Specify CBF, UDL, SSI, SSR and TEMP loads along beam centroidal axes

418 Output stress resultants relative to beam centroidal axes for eccentric elements

Notes on Use

1. The element formulation is based on the constrained super-parametric approach. The variation of axial force along the beam is linear. The variation of displacement is quadratic in the local x-direction and cubic in the local y-direction. Shear force is constant.
2. Input of loads (OPTION 406), and output of stress/strain resultants (OPTION 418) are with respect to the beam centroidal axis. CL is always input with respect to the nodal line; displacements are output with respect to the nodal line. Fiber stress/strain results are output at the actual location
3. Initial strain resultants may be input for any material model.
4. The number of numerical cross-section integration points, nt12 and nt14, may be specified but for improved performance the number of integration points corresponding to the y direction can be defined correctly (the beam bends about the local z-axis) and the integration rule in the other direction may be set to 1.
5. For nonlinear material model 29 ifcode must be set to 2 for solid rectangular sections. Multiple quadrilateral cross-sections can be used to build up complex beam cross-sections.
6. Temperature dependent properties cannot be used with material model 29.
7. The element should not be coupled to the face of a two dimensional continuum element because of the midside node incompatibility.
8. Computing the [rigidity matrix](#) by integration through the cross-section depth of the beam is necessary for all nonlinear material models (except 29). By default option 172 is invoked automatically and a 5 point [Newton-Cotes integration](#) rule is used.
9. By default, the [rigidity matrix](#) is evaluated explicitly for linear materials. A 3 point [Newton-Cotes](#) rule may be invoked using option 172. Numerical cross section integration enables top, middle and bottom stress output.

Restrictions

- [Ensure mid-side node centrality](#)
- Avoid excessive element curvature

Recommendations on Use

The element may be used for linear and nonlinear analysis of two dimensional beam, frame and arch structures. The 2-noded straight beam (BMI2) is more effective for

linear analysis of structures containing straight members of constant cross-section, e.g. plane frames.

3D Kirchhoff Thin Beam Elements

General

Element Name	BS3	
Element Group	Beams	
Element Subgroup	Kirchhoff Beams	
Element Description	Curved beam elements in 3D for which shearing deformations are excluded. The elements can accommodate varying geometric properties along the length.	
Number Of Nodes	3 (BS3).	
Freedom	4 (BS4). The 4th node is used to define the local xy-plane. U, V, W, θ_x , θ_y , θ_z : at end nodes (1 and 3) dU, d θ_x : (relative displacement/rotation) at mid-length node.	
Node Coordinates	X, Y, Z: at each node.	

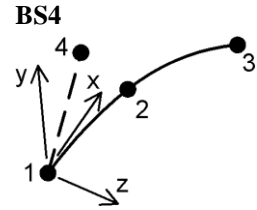

Geometric Properties

A, Iyy, Izz, Jxx, Iy, Iz, Iyz, ez, ey	At each node
SF1,SF2,SF3,SF4,SF5,SF6,SF7,SF8,SF9	Optional scale factors applied to the geometric properties in the calculation of the stiffness and mass matrices
MF1,MF2,MF3,MF4,MF5,MF6,MF7,MF8,MF9	
A	Cross sectional area
Iyy, Izz	2nd moment of area about local y, z directions (see Definition)
Jxx	Torsional constant .
Iy, Iz	1st moment of area about local y, z directions (see Definition)
Iyz	Product moment of area (see Definition)
ez	Eccentricity from beam xy-plane to nodal line. (+ve in the +ve

local z direction). (See Notes)
ey Eccentricity from beam xz-plane to nodal line. (+ve in the +ve local y direction). (See Notes)

For MATERIAL MODEL 29 additional geometric properties are appended to the previous 21 geometric properties (see *Notes*).

Material Properties

Linear	Isotropic: Rigidities:	MATERIAL PROPERTIES (Elastic: Isotropic) RIGIDITIES 6 (Rigidities: Beam)
Matrix	Not applicable	
Joint	Not applicable	
Concrete	Not applicable	
Elasto-Plastic	Stress resultant:	MATERIAL PROPERTIES NONLINEAR 29 (Elastic: Isotropic, Plastic: Resultant) (ifcode=1 or 2, see <i>Notes</i>)
Creep	AASHTO	CREEP PROPERTIES (Creep) MATERIAL PROPERTIES NONLINEAR 86 AASHTO (Concrete creep model to AASHTO code of Practice)
	CEB-FIP	MATERIAL PROPERTIES NONLINEAR 86 CEB-FIP (Concrete creep model to CEB-FIP Model Code 1990)
	Chinese	MATERIAL PROPERTIES NONLINEAR 86 CHINESE (Chinese creep model to Chinese Code of Practice)
	Eurocode	MATERIAL PROPERTIES NONLINEAR 86 EUROCODE (Concrete creep model to EUROCODE_2)
	IRC	MATERIAL PROPERTIES NONLINEAR 86 IRC (Concrete creep model to Indian IRC code of Practice)
Damage	Not applicable	

Viscoelastic	Not applicable	
Shrinkage		SHRINKAGE CEB_FIP_90, EUROCODE_2, GENERAL, USER
Rubber	Not applicable	
Generic Polymer	Not applicable	
Composite	Not applicable	

Loading

Prescribed Value	PDSP, TPDSP	Prescribed variable. U, V, W, θ_x , θ_y , θ_z : at end nodes (1 and 3). dU, d θ_x : at mid-length node.
Concentrated Loads	CL	Concentrated loads. P _x , P _y , P _z , M _x , M _y , M _z : at end nodes. dP _x , dM _y : at mid-length node.
Element Loads	ELDS	<p>Element loads on nodal line (load type number LTYPE *10 defines the corresponding element load type on beam axis)</p> <p>LTYPE, S1, P_x, P_y, P_z, M_x, M_y, M_z LTYPE=11: point loads and moments in local directions. LTYPE=12: point loads and moments in global directions. LTYPE, 0, W_x, W_y, W_z, M_x, M_y, M_z LTYPE=21: uniformly distributed loads in local directions. LTYPE=22: uniformly distributed loads in global directions. LTYPE=23: uniformly distributed projected loads in global directions. LTYPE, S1, W_{x1}, W_{y1}, W_{z1}, M_{x1}, M_{y1}, M_{z1}, S2, W_{x2}, W_{y2}, W_{z2}, M_{x2}, M_{y2}, M_{z2} LTYPE=31: distributed loads in local directions. LTYPE=32: distributed loads in global directions. LTYPE=33: distributed projected loads in global directions. LTYPE, S1, W_x, W_y, W_z, M_x, M_y, M_z LTYPE=41: trapezoidal loads in local directions. LTYPE=42: trapezoidal loads in global</p>

		directions.
		LTYPE=43: trapezoidal projected loads in global directions.
Distributed Loads	UDL	Uniformly distributed loads. W_x , W_y , W_z : local forces/unit length.
	FLD, FLDG	Not applicable.
Body Forces	CBF	Constant body forces for element. X_{cbf} , Y_{cbf} , Z_{cbf} , Ω_x , Ω_y , Ω_z
	BFP, BFPE	Body force potentials at nodes/for element. ϕ_1 , ϕ_2 , ϕ_3 , 0, X_{cbf} , Y_{cbf} , Z_{cbf}
Velocities	VELO	Velocities. V_x , V_y , V_z : at nodes.
Accelerations	ACCE	Acceleration A_x , A_y , A_z : at nodes
Viscous Support Loads	VSL	Viscous support loads. VL_x , VL_y , VL_z : at nodes.
Initial Stress/Strains	SSI, SSIE	Initial stresses/strains at nodes/for element. F_x , M_y , M_z , T_{xz} , T_{xy} , 0: axial force, moments and torques in local directions. ϵ_x , ψ_y , ψ_z , ψ_{xz} , ψ_{xy} , 0: axial, flexural and torsional strains in local directions. Total torque = $T_{xz} + T_{xy}$, total torsional strain = $y_{xz} + \psi_{xy}$.
	SSIG	Not applicable.
Residual Stresses	SSR, SSRE	Not applicable.
	SSRG	Residual stresses at Gauss points. Resultants (for material model 29). F_x , M_y , M_z , T_{xz} , T_{xy} , 0: axial force, moments and torques in local directions. Total torque = $T_{xz} + T_{xy}$, total torsional strain = $y_{xz} + \psi_{xy}$.
Target Stress/Strains	TSSIE, TSSIA	Target stresses/strains at nodes/for element. F_x , M_y , M_z , T_{xz} , T_{xy} , 0: axial force, moments and torques in local directions. ϵ_x , ψ_y , ψ_z , ψ_{xz} , ψ_{xy} , 0: axial, flexural and torsional strains in local directions. Total torque = $T_{xz} + T_{xy}$, total torsional strain = $y_{xz} + \psi_{xy}$.
	TSSIG	Not applicable.
Temperatures	TEMP, TMPE	Temperatures at nodes/for element. T , 0, dT/dy , dT/dz , To , 0, dTo/dy , dTo/dz
Overburden	Not applicable.	
Phreatic Surface	Not applicable.	

Field Loads	Not applicable.
Temp Dependent Loads	Not applicable.

LUSAS Output

Solver	Force (default): F_x , F_y , F_z , M_y , M_z , T_{xz} , T_{xy} : axial force, moments, torques and shear forces in local directions. (Total torque = $T_{xz}+T_{xy}$). Strain: ϵ_x , ψ_y , ψ_z , ψ_{xz} , ψ_{xy} , 0: axial, flexural and torsional strains in local directions. By default element output is with respect to the nodal line. OPTION 418 outputs stress/strain resultants with respect to the beam centroidal axes.
Modeller	See Results Tables (Appendix K) .

Local Axes

For BS3 the local xy-plane is defined by the 3 element nodes. The local y-axis is perpendicular to the local x-axis and positive on the convex side of the element. The local y and z-axes form a right handed set with the local x-axis.

For BS4 the local xy-plane is defined by the 2 end nodes of the beam and the 4th node. The local y-axis is perpendicular to the local x-axis and positive on the side of the element where the 4th node lies. The local y and z-axes form a right handed set with the local x-axis. See [Local Element Axes](#) for more details.

Sign Convention

- [Standard beam element](#)

Formulation

Geometric Nonlinearity

Total Lagrangian	For large displacements, small rotations and small strains.
Updated Lagrangian	For large displacements, large rotations and small strains.
Eulerian	Not applicable.
Co-rotational	Not applicable.

Integration Schemes

Stiffness	Default.	2-point.
	Fine (see	3-point.

Options).
Mass Default. 2-point.
Fine (see 3-point.
Options).

A 3-point [Newton-Cotes](#) integration rule is also available using option 134. This may be more applicable for infinitesimal strain, elastoplastic analyses of plane frames with straight members since the first and third quadrature points will coincide with the frame joints. See Appendix I of the Theory manual.

Mass Modelling

- Consistent mass (default).
- Lumped mass.

Options

- 18 Invokes fine integration rule for element.
- 54 Updated Lagrangian geometric nonlinearity.
- 55 Output strains as well as stresses.
- 87 Total Lagrangian geometric nonlinearity.
- 102 Switch off load correction stiffness matrix due to centripetal acceleration.
- 105 Lumped mass matrix.
- 134 Gauss to [Newton-Cotes](#) in plane (in the local x direction) integration for elements.
- 157 Material model 29 (non cross-section elements), see *Notes*.
- 170 Suppress transfer of shape function arrays to disk.
- 405 Specify geometric properties along beam centroidal axes
- 406 Specify CBF, UDL, SSI, SSR and TEMP loads along beam centroidal axes
- 418 Output stress resultants relative to beam centroidal axes for eccentric elements

Notes on Use

1. The element formulation is based on the [Kirchhoff](#) hypothesis for thin beams (i.e. the exclusion of shearing deformations).
2. The variation of axial force, moments and torsion along the length of the beam can be regarded as linear. Shear force variations are constant.
3. Input of geometric properties (OPTION 405) and loads (OPTION 406), and output of stress/strain resultants (OPTION 418) are with respect to the beam centroidal axes. CL is always input with respect to the nodal line; displacements are output with respect to the nodal line.
4. For nonlinear material model 29 the following geometric properties are appended to those already specified (see *Geometric Properties*).

- $A^P, Z_{yy}^P, Z_{zz}^P, Z_y^P, Z_z^P, S^P$ at each node (i.e. nodes 1, 2, 3).
- A^P Plastic area (=elastic area)
- Z_{yy}^P, Z_{zz}^P Plastic moduli for bending about y, z axes
- Z_y^P, Z_z^P Plastic moduli for torsion about y, z axes.
- S^P Plastic area for shear ($S^P=0$).

Where the fully plastic torsional moment = $\sigma_y (Z_y^P + Z_z^P)$.

5. For nonlinear material model 29 the following ifcode parameters should be used
 - ifcode=1 for circular hollow sections.
 - ifcode=2 for solid rectangular sections.
6. Temperature dependent properties cannot be used with material model 29.
7. The element should not be coupled to the edges of either continuum or shell elements because of midside node incompatibility.
8. The [rigidity matrix](#) for BS3 and BS4 is evaluated explicitly from the geometric properties for both linear and nonlinear materials.
9. Stiffness and mass factors allow different geometric properties to be used in the calculation of the stiffness and mass matrices. Stiffness factors are also used in the processing of stress and strains loads whilst the mass factors are used in the processing of body forces loads. The values are input after all geometric properties and the keyword `MODIFICATION_FACTORS` must be added to the `GEOMETRIC PROPERTIES` input command.

Restrictions

- [Ensure mid-side node centrality](#)
- Avoid excessive element curvature

Recommendations on Use

The elements may be used for linear and nonlinear analysis of three dimensional beam, frame and arch structures. The 2-noded straight beam (BMI21) is more effective for linear analysis of structures containing straight members of constant cross-section, e.g. space frames.

3D Kirchhoff Thin Beam Element with Quadrilateral Cross-Section

General

Element Name

BSX4

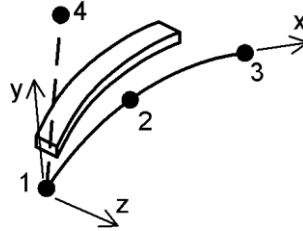
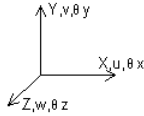

Element Group

Beams

Element Subgroup

[Kirchhoff](#) Beams

Element Description

Curved beam elements in 3D for which shearing deformations are excluded. The element has a quadrilateral cross section which may vary along the element length.

Number Of Nodes

4. The 4th node is used to define the local xy-plane.

Freedom

U, V, W, θ_x , θ_y , θ_z : at the end nodes (1 and 3)
 dU , $d\theta_x$: (relative displacement/rotation) at the mid-length node.

Node Coordinates

X, Y, Z: at each node.

Geometric Properties

$y_1, z_1, y_2, z_2, y_3, z_3, y_4, z_4$: local cross section coordinate pairs at each node; followed by nt_{12}, nt_{14} : specifying the number of [Newton-Cotes](#) integration points in the direction defined by the local cross-section points 1-2 and 1-4 (zero indicates default values). Multiple quadrilateral cross-sections can be used to build up complex beam cross-sections.

Note. The coordinates of the cross section are numbered clockwise about the local x-axis (the beam nodal line). That is, a right-hand screw rule in the direction of increasing x.

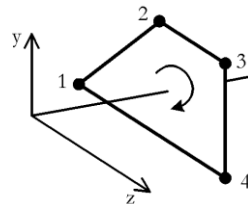

Material Properties

Linear	Isotropic:	MATERIAL PROPERTIES (Elastic: Isotropic)	
Matrix	Not applicable		
Joint	Not applicable		
Concrete	Not applicable		
Elasto-Plastic	Stress resultant:	Not applicable.	
	Tresca:	MATERIAL PROPERTIES NONLINEAR 61 (Elastic: Isotropic, Plastic: Tresca, Hardening: Isotropic Hardening Gradient, Isotropic Plastic Strain or Isotropic Total Strain)	
	Drucker-Prager:	MATERIAL PROPERTIES NONLINEAR 64 (Elastic: Isotropic, Plastic: Drucker-Prager, Hardening: Granular)	
	Mohr-Coulomb:	MATERIAL PROPERTIES NONLINEAR 65 (Elastic: Isotropic, Plastic: Mohr-Coulomb, Hardening: Granular with Dilation)	
	Optimised Implicit Von Mises:	MATERIAL PROPERTIES NONLINEAR 75 (Elastic: Isotropic, Plastic: Von Mises, Hardening: Isotropic & Kinematic)	
	Volumetric Crushing:	Not applicable	
	Stress Potential	STRESS POTENTIAL VON_MISES (Isotropic: von Mises, Modified von Mises)	
	Creep		CREEP PROPERTIES (Creep)
		AASHTO	MATERIAL PROPERTIES NONLINEAR 86 AASHTO (Concrete creep model to AASHTO code of Practice)
		CEB-FIP	MATERIAL PROPERTIES NONLINEAR 86 CEB-FIP (Concrete creep model to CEB-FIP Model Code 1990)
Chinese		MATERIAL PROPERTIES NONLINEAR 86 CHINESE (Chinese creep model to Chinese Code of Practice)	
Eurocode		MATERIAL PROPERTIES NONLINEAR 86 EUROCODE (Concrete creep model to EUROCODE_2)	
IRC		MATERIAL PROPERTIES NONLINEAR 86	

		IRC (Concrete creep model to Indian IRC code of Practice)
Damage		DAMAGE PROPERTIES SIMO, OLIVER (Damage)
Viscoelastic Shrinkage	Not applicable	SHRINKAGE CEB_FIP_90, EUROCODE_2, GENERAL, USER
Rubber	Not applicable	
Generic Polymer	Not applicable	
Composite	Not applicable	

Loading

Prescribed Value	PDSP, TPDSP	Prescribed variable. U, V, W, θ_x , θ_y , θ_z : at the end nodes. dU, d θ_x : at the mid-length node.
Concentrated Loads	CL	Concentrated loads. P _x , P _y , P _z , M _x , M _y , M _z : at end nodes (global). dP _x , dM _x : at mid-length local node.
Element Loads	ELDS	<p>Element loads on nodal line (load type number LTYPE *10 defines the corresponding element load type on beam axis)</p> <p>LTYPE, S1, P_x, P_y, P_z, M_x, M_y, M_z LTYPE=11: point loads and moments in local directions. LTYPE=12: point loads and moments in global directions. LTYPE, 0, W_x, W_y, W_z, M_x, M_y, M_z LTYPE=21: uniformly distributed loads in local directions. LTYPE=22: uniformly distributed loads in global directions. LTYPE=23: uniformly distributed projected loads in global directions. LTYPE, S1, W_{x1}, W_{y1}, W_{z1}, M_{x1}, M_{y1}, M_{z1}, S2, W_{x2}, W_{y2}, W_{z2}, M_{x2}, M_{y2}, M_{z2} LTYPE=31: distributed loads in local directions. LTYPE=32: distributed loads in global directions. LTYPE=33: distributed projected loads in global directions. LTYPE, S1, W_x, W_y, W_z, M_x, M_y, M_z LTYPE=41: trapezoidal loads in local</p>

		directions.
		LTYPE=42: trapezoidal loads in global directions.
		LTYPE=43: trapezoidal projected loads in global directions.
Distributed Loads	UDL	Uniformly distributed loads. W_x, W_y, W_z : forces/unit length in local directions.
	FLD, FLDG	Not applicable
Body Forces	CBF	Constant body forces for element. $X_{cbf}, Y_{cbf}, Z_{cbf}, \Omega_x, \Omega_y, \Omega_z, \alpha_x, \alpha_y, \alpha_z$
	BFP, BFPE	Body force potentials at nodes/for element. $\phi_1, \phi_2, \phi_3, 0, X_{cbf}, Y_{cbf}, Z_{cbf}$
Velocities	VELO	Velocities. V_x, V_y, V_z : at nodes.
Accelerations	ACCE	Acceleration A_x, A_y, A_z : at nodes
Viscous Support Loads	VSL	Viscous support loads. VL_x, VL_y, VL_z : at nodes.
Initial Stress/Strains	SSI, SSIE	Initial stresses/strains at nodes/for element. Components: $F_x, M_y, M_z, 0, 0, 0, \epsilon_x, \psi_y, \psi_z, 0, 0, 0, (\sigma_x, \sigma_{xy}, \sigma_{xz}, \sigma_{yz}, \epsilon_{yz}, \epsilon_x, \epsilon_{xz}, \epsilon_{yz})$ Bracketed terms repeated for each fibre integration point.
	SSIG	Initial stresses/strains at Gauss points. These stresses/strains are specified in the same manner as SSI and SSIE.
Residual Stresses	SSR, SSRE	Residual stresses at nodes/for element. Components: $0, 0, 0, 0, 0, 0, 0, 0, 0, 0, 0, 0, (\sigma_x, \sigma_{xy}, \sigma_{xz}, \sigma_{yz},)$ Bracketed terms repeated for each fibre integration point.
	SSRG	Residual stresses at Gauss points. These stresses are specified in the same manner as SSR and SSRE.
Target Stress/Strains	TSSIE, TSSIA	Target stresses/strains at nodes/for element. Components: $F_x, M_y, M_z, 0, 0, 0, \epsilon_x, \psi_y, \psi_z, 0, 0, 0, 0, 0, 0, 0, 0, 0, 0, 0, 0, 0, 0, 0, 0, 0, 0, (\sigma_x, \sigma_{xy}, \sigma_{xz}, \sigma_{yz}, \epsilon_{yz}, \epsilon_x, \epsilon_{xz}, \epsilon_{yz})$ Bracketed terms repeated for each fibre integration point.
	TSSIG	Target stresses/strains at Gauss points. These stresses/strains are specified in the same manner as TSSIE and TSSIA.
Temperatures	TEMP, TMPE	Temperatures at nodes/for element. $T, 0, dT/dy,$

dT/dz , T_0 , 0 , dT_0/dy , dT_0/dz : in local directions.

Overburden	Not applicable.
Phreatic Surface	Not applicable.
Field Loads	Not applicable
Temp Dependent Loads	Not applicable

LUSAS Output

Solver	Force (default): F_x , M_y , M_z , T_{xz} , T_{xy} , F_y , F_z : axial force, moments, torques and shear forces in local directions. (Total Torque = $T_{xz} + T_{xy}$). Continuum stresses (OPTION 172): σ_x , σ_{xy} , σ_{xz} , σ_{yz} : in local directions. Strain: ϵ_x , ψ_y , ψ_z , ψ_{xz} , ψ_{xy} : axial, flexural and torsional strains in local directions. Continuum strains (OPTION 172): ϵ_x , ϵ_{xy} , ϵ_{xz} , ϵ_{yz} : in local directions. By default element output is with respect to the nodal line. OPTION 418 outputs stress/strain resultants with respect to the beam centroidal axes.
Modeller	See Results Tables (Appendix K) .

Local Axes

[Standard line element](#). The local xy -plane is defined by the 2 end nodes of the beam and the 4th node. The local y -axis is perpendicular to the x -axis and positive on the side of the element where the 4th node lies.

The local y and z -axes form a right-hand set with the local x -axis.

Sign Convention

- [Standard beam element](#)

Formulation

Geometric Nonlinearity

Total Lagrangian	For large displacements, small rotations and small strains.
Updated	For large displacements, large rotations and small strains.

Lagrangian	
Eulerian	Not applicable.
Co-rotational	Not applicable.

Integration Schemes

Stiffness	Default.	2-point.
	Fine (see <i>Options</i>).	3-point.
Mass	Default.	2-point.
	Fine (see <i>Options</i>).	3-point.

A 3-point [Newton-Cotes](#) integration rule is also available using option 134. This may be more applicable for infinitesimal strain, elastoplastic analyses of plane frames with straight members since the first and third quadrature points will coincide with the frame joints. See Appendix I of the Theory manual.

Mass Modelling

- Consistent mass (default).
- Lumped mass.

Options

- 18** Invokes fine integration rule for element.
- 54** Updated Lagrangian geometric nonlinearity.
- 55** Output strains as well as stresses.
- 87** Total Lagrangian geometric nonlinearity.
- 102** Switch off load correction stiffness matrix due to centripetal acceleration.
- 105** Lumped mass matrix.
- 134** Gauss to [Newton-Cotes](#) in plane (in the local x direction) integration for elements.
- 139** Output yielded integration points only.
- 170** Suppress transfer of shape function arrays to disk.
- 172** Form the [rigidity matrix](#) by numerical cross section integration.
- 406** Specify CBF, UDL, SSI, SSR and TEMP loads along beam centroidal axes
- 418** Output stress resultants relative to beam centroidal axes for eccentric elements

Notes, Assumptions and Limitations

1. The element formulation is based on the [Kirchhoff](#) hypothesis for thin beams (i.e. the exclusion of shearing deformations)
2. The variation of axial force, moments and torsion along the length of the beam can be regarded as linear. Shear force is constant.

3. Input of loads (OPTION 406), and output of stress/strain resultants (OPTION 418) are with respect to the beam centroidal axes. CL is always input with respect to the nodal line; displacements are output with respect to the nodal line. Fiber stress/strain results are output at their actual location
4. Computation of the [rigidity matrix](#) by integration over the thickness is necessary for all nonlinear material models. For nonlinear models a 5x5 [Newton-Cotes integration](#) rule is used as default. For linear models a 3x3 rule is used as the default. This allows the output of stresses at the numerical cross section integration points.
5. The torsional constant is estimated from the computed values for I_{yy} and I_{zz} , $J_{xx} = I_{yy} + I_{zz}$.
6. For nonlinear material models, fibre integration is used across the cross-sectional area of the beam. Only axial deformation is considered in the plasticity computations, any torsional deformation is assumed to remain elastic.
7. The element should not be coupled to the face of a two dimensional continuum element because of the midside node incompatibility
8. Computing the [rigidity matrix](#) by integration through the cross-section depth of the beam is necessary for all nonlinear material models (except 29). By default OPTION 172 is invoked automatically and a 5*5 point [Newton-Cotes integration](#) rule is used.
9. By default, the [rigidity matrix](#) is evaluated explicitly for linear materials. A 3*3 point [Newton-Cotes integration](#) rule may be invoked using OPTION 172. Numerical cross section integration enables top, middle and bottom stress output.

Restrictions

- [Ensure mid-side node centrality](#)
- Avoid excessive element curvature

Recommendations on Use

The elements may be used for linear and nonlinear analysis of three dimensional beam, frame and arch structures. The 2-noded straight beam (BMI21) is more effective for linear analysis of structures containing straight members of constant cross-section, e.g. space frames.

3D Semiloof Thin Beam Elements

General

Element Name BSL3, BSL4

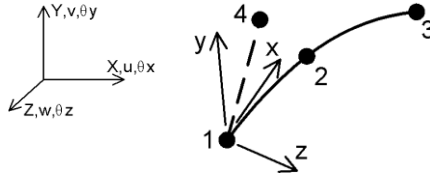

Element Group	Beams
Element Subgroup	Semiloof Beams
Element Description	Curved beam elements in 3D which can be mixed with the semiloof shell elements TSL6 and QSL8. The elements can accommodate varying geometric properties. Shearing deformations are excluded.
Number Of Nodes	3 or 4. For BSL4 the 4th node is used to define the local xy-plane.
Freedom	U, V, W, θ_x , θ_y , θ_z : at end nodes (1 and 3). U, V, W, θ_1 , θ_2 : at mid-side node (node 2) (see <i>Notes</i>).
Node Coordinates	X, Y, Z: at each node.

Geometric Properties

A, Iyy, Izz, Jxx, Iy, Iz, Iyz, ez, ey	at nodes 1, 2 and 3
SF1,SF2,SF3,SF4,SF5,SF6,SF7,SF8,SF9	Optional scale factors applied to the geometric properties in the calculation of the stiffness and mass matrices
MF1,MF2,MF3,MF4,MF5,MF6,MF7,MF8,MF9	
A	Cross sectional area
Iyy, Izz	2nd moments of area in local y, z axes (see Definition)
Jxx	Torsional constant .
Iy, Iz	1st moment of area in local y, z axes (see Definition)
Iyz	Product moment of area (see Definition).
ez	Eccentricity from beam xy-plane to nodal line (+ve in +ve local z-direction)

ey Eccentricity from beam xz-plane to nodal line (+ve in +ve local y-direction)

For MATERIAL MODEL 29 additional geometric properties are appended to the 21 properties above; see *Notes*.

Material Properties

Linear	Isotropic: Rigidities:	MATERIAL PROPERTIES (Elastic: Isotropic) RIGIDITIES Rigidities 6 (Rigidities: Beam)
Matrix	Not applicable	
Joint	Not applicable	
Concrete	Not applicable	
Elasto-Plastic	Stress resultant:	MATERIAL PROPERTIES NONLINEAR 29 (Elastic: Isotropic, Plastic: Resultant) (ifcode=1 or 2, see <i>Notes</i>)
Creep	AASHTO	CREEP PROPERTIES (Creep) MATERIAL PROPERTIES NONLINEAR 86 AASHTO (Concrete creep model to AASHTO code of Practice)
	CEB-FIP	MATERIAL PROPERTIES NONLINEAR 86 CEB-FIP (Concrete creep model to CEB-FIP Model Code 1990)
	Chinese	MATERIAL PROPERTIES NONLINEAR 86 CHINESE (Chinese creep model to Chinese Code of Practice)
	Eurocode	MATERIAL PROPERTIES NONLINEAR 86 EUROCODE (Concrete creep model to EUROCODE_2)
	IRC	MATERIAL PROPERTIES NONLINEAR 86 IRC (Concrete creep model to Indian IRC code of Practice)
Damage	Not applicable	
Viscoelastic	Not	

	applicable	
Shrinkage		SHRINKAGE CEB_FIP_90, EUROCODE_2, GENERAL, USER
Rubber	Not applicable	
Generic Polymer	Not applicable	
Composite	Not applicable	

Loading

Prescribed Value	PDSP, TPDSP	Prescribed variable. U, V, W, θ_x , θ_y , θ_z : at end nodes. U, V, W, θ_1 , θ_2 : at mid-side node.
Concentrated Loads	CL	Concentrated loads. Px, Py, Pz, Mx, My, Mz: at end nodes (global). Px, Py, Pz, M1, M2: at mid-side node (M1 and M2 local).
Element Loads	ELDS	<p>Element loads on nodal line (load type number LTYPE *10 defines the corresponding element load type on beam axis)</p> <p>LTYPE, S1, Px, Py, Pz, Mx, My, Mz</p> <p>LTYPE=11: point loads and moments in local directions.</p> <p>LTYPE=12: point loads and moments in global directions.</p> <p>LTYPE, 0, Wx, Wy, Wz, Mx, My, Mz</p> <p>LTYPE=21: uniformly distributed loads in local directions.</p> <p>LTYPE=22: uniformly distributed loads in global directions.</p> <p>LTYPE=23: uniformly distributed projected loads in global directions.</p> <p>LTYPE, S1, Wx1, Wy1, Wz1, Mx1, My1, Mz1, S2, Wx2, Wy2, Wz2, Mx2, My2, Mz2</p> <p>LTYPE=31: distributed loads in local directions.</p> <p>LTYPE=32: distributed loads in global directions.</p> <p>LTYPE=33: distributed projected loads in global directions.</p> <p>LTYPE, S1, Wx, Wy, Wz, Mx, My, Mz</p> <p>LTYPE=41: trapezoidal loads in local directions.</p> <p>LTYPE=42: trapezoidal loads in global</p>

		directions.
		LTYPE=43: trapezoidal projected loads in global directions.
Distributed Loads	UDL	Uniformly distributed loads. W_x, W_y, W_z : force/unit length in local directions for element.
	FLD, FLDG	Not applicable.
Body Forces	CBF	Constant body forces for element. $X_{cbf}, Y_{cbf}, Z_{cbf}, \Omega_x, \Omega_y, \Omega_z, \alpha_x, \alpha_y, \alpha_z$
	BFP, BFPE	Body force potentials at nodes/for element. $\phi_1, \phi_2, \phi_3, 0, X_{cbf}, Y_{cbf}, Z_{cbf}$
Velocities	VELO	Velocities. V_x, V_y, V_z : at nodes.
Accelerations	ACCE	Accelerations. A_x, A_y, A_z : at nodes.
Viscous Support Loads	VSL	Viscous support loads. VL_x, VL_y, VL_z : at nodes.
Initial Stress/Strains	SSI, SSIE	Initial stresses/strains at nodes/for element. $F_x, M_y, M_z, T_{xz}, T_{xy}, 0$ in local directions. $\epsilon_x, \psi_y, \psi_z, \psi_{xz}, \psi_{xy}, 0$: in local directions. (see <i>Notes</i>). Total torque = $T_{xz} + T_{xy}$
	SSIG	Not applicable.
Residual Stresses	SSR, SSRE	Residual stresses at nodes/for element. Resultants (nonlinear model 29): $F_x, M_y, M_z, T_{xz}, T_{xy}, 0$: in local directions.
	SSRG	Not applicable.
Target Stress/Strains	TSSE, TSSIA	Target stresses/strains at nodes/for element. $F_x, M_y, M_z, T_{xz}, T_{xy}, 0$ in local directions. $\epsilon_x, \psi_y, \psi_z, \psi_{xz}, \psi_{xy}, 0$: in local directions. (see <i>Notes</i>). Total torque = $T_{xz} + T_{xy}$
	TSSIG	Not applicable.
Temperatures	TEMP, TMPE	Temperatures at nodes/for element. $T, 0, dT/dy, dT/dz, T_0, 0, dT_0/dy, dT_0/dz$: in local directions.
Overburden	Not applicable.	
Phreatic Surface	Not applicable.	
Field Loads	Not applicable.	
Temp Dependent Loads	Not applicable.	

LUSAS Output

Solver Force (default): F_x , M_y , M_z , T_{xz} , T_{xy} , F_y , F_z : in local directions.
(Total torque = $T_{xz} + T_{xy}$)
Strain: ϵ_x , ψ_y , ψ_z , ψ_{xz} , ψ_{xy} : in local directions. (see *Notes*).
Total torsional strain = $\psi_{xz} + \psi_{xy}$
By default element output is with respect to the nodal line.
OPTION 418 outputs stress/strain resultants with respect to the beam centroidal axes.

Modeller See [Results Tables \(Appendix K\)](#).

Local Axes

Standard line element. For BSL3 the local xy-plane is defined by the 3 element nodes. The local y-axis is perpendicular to the local x-axis and positive on the convex side of the element. The local y and z-axes form a right-hand set with the local x-axis. For BSL4 the local xy-plane is defined by the 2 end nodes of the beam and the 4th node. The local y-axis is perpendicular to the x-axis and positive on the side of the element where the 4th node lies. The local y and z-axes form a right-hand set with the local x-axis.

Sign Convention

- Standard beam element

Formulation

Geometric Nonlinearity

Total Lagrangian	For large displacements, small rotations and small strains.
Updated Lagrangian	Not applicable.
Eulerian	Not applicable.
Co-rotational	Not applicable.

Integration Schemes

Stiffness	Default.	3-point torsion, 2-point bending.
	Fine.	As default.
Mass	Default.	3-point.
	Fine.	As default.

Mass Modelling

- Consistent mass (default).
- Lumped mass.

Options

- 55 Output strains as well as stresses.
- 87 Total Lagrangian geometric nonlinearity
- 102 Switch off load correction stiffness matrix due to centripetal acceleration.
- 105 Lumped mass matrix.
- 157 Material model 29 (non cross-section elements), see *Notes*.
- 170 Suppress transfer of shape function arrays to disk.
- 405 Specify geometric properties along beam centroidal axes
- 406 Specify CBF, UDL, SSI, SSR and TEMP loads along beam centroidal axes
- 418 Output stress resultants relative to beam centroidal axes for eccentric elements

Notes on Use

1. The semiloof beam element is based on a [Kirchhoff](#) hypothesis for thin beams (i.e. the exclusion of shearing deformations).
2. The variation of axial force, moments and torsion can be regarded as linear along the length of the element. Shear forces are constant along the length of the element.
3. The loof rotations θ_1 and θ_2 refer to rotations about the element at the loof positions. A positive loof rotation is defined by a right-hand screw rule applied to a vector running in the local x-axis direction along the element edge.
4. Input of geometric properties (OPTION 405) and loads (OPTION 406), and output of stress/strain resultants (OPTION 418) are with respect to the beam centroidal axes. CL is always input with respect to the nodal line; displacements are output with respect to the nodal line.
5. For nonlinear material model 29 the following geometric properties are appended to those already specified (see *Geometric Properties*).
 - A^P , Z_{yy}^P , Z_{zz}^P , Z_y^P , Z_z^P , S^P at each node (i.e. nodes 1, 2, 3).
 - A^P Plastic area (=elastic area)
 - Z_{yy}^P , Z_{zz}^P Plastic moduli for bending about y, z axes
 - Z_y^P , Z_z^P Plastic moduli for torsion about y, z axes.
 - S^P Plastic area for shear ($S^P=0$).

Where the fully plastic torsional moment = $\sigma_y (Z_y^P + Z_z^P)$

6. For nonlinear material model 29 the following ifcode parameters should be
 - ifcode=1 for circular hollow sections.
 - ifcode=2 for solid rectangular sections.
7. Semiloof beam elements should be used with semiloof shell elements. For beam only problems, BS3/BS4 elements should be used.
8. Temperature dependent properties cannot be used with material model 29.
9. Integration of the element stiffness matrix is performed using selective integration, with a 2-point Gauss rule for the axial and flexural strain energy, and a 3-point Gauss rule for the torsional strain energy. The selective integration technique is implemented in a similar manner to the method proposed by Hughes [H4], i.e. the strain-displacement matrix for the bending and axial strains is evaluated at the reduced rule quadrature points and then extrapolated to the sampling locations of the 3-point quadrature rule. The material response is then assessed at the 3-point Gauss rule.
10. The [rigidity matrix](#) for BSL3 and BSL4 is evaluated explicitly from the geometric properties for both linear and nonlinear materials.
11. Stiffness and mass factors allow different geometric properties to be used in the calculation of the stiffness and mass matrices. Stiffness factors are also used in the processing of stress and strains loads whilst the mass factors are used in the processing of body forces loads. The values are input after all geometric properties and the keyword MODIFICATION_FACTORS must be added to the GEOMETRIC PROPERTIES input command

Restrictions

- [Ensure mid-side node centrality](#)
- Avoid excessive element curvature

Recommendations on Use

- The primary use of this element is to provide a beam stiffener for the semiloof shell (QSL8) for analysing stiffened shell structures.
- The BS3 and BS4 elements are more effective for linear analysis of 3D frame structures with curved members and nonlinear analysis of three dimensional beam, frame and arch structures.

- The 2-noded straight beam (BM121) is the most effective for linear analysis of structures containing straight members of constant cross-section, e.g. space frames.

3D Semiloof Thin Beam Element with Quadrilateral Cross-Section

General

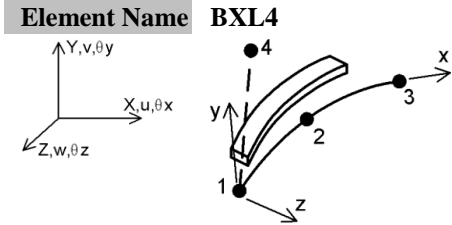

Element Group	Beams
Element Subgroup	Semiloof Beams
Element Description	A curved beam element in 3D which can be mixed with the semiloof shell element. The element has a quadrilateral cross section which may vary along the element. Shearing deformations are excluded.
Number Of Nodes	4. The 4th node is used to define the local xy-plane.
Freedom	U, V, W, θ_x , θ_y , θ_z : at end nodes. U, V, W, θ_1 , θ_2 : at mid-length node.
Node Coordinates	X, Y, Z: at each node.

Geometric Properties

$y_1, z_1, y_2, z_2, y_3, z_3, y_4, z_4$: local cross section coordinate pairs at each node; followed by nt_{12}, nt_{14} : number of [Newton-Cotes](#) integration points in the direction defined by the local cross-section points 1-2 and 1-4 (zero indicates default values). Multiple quadrilateral cross-sections can be used to build up complex beam cross-sections.

Note. The corners of the quadrilateral are numbered clockwise about the local x-axis (the beam nodal line), that is, a right-hand screw rule in the direction of increasing x.

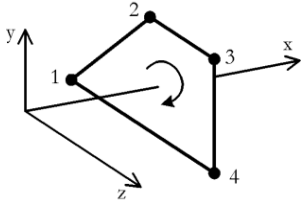

Material Properties

Linear Isotropic: MATERIAL PROPERTIES (Elastic: Isotropic)

Matrix	Not applicable
Joint	Not applicable
Concrete	Not applicable
Elasto-Plastic	Stress resultant: Not applicable.
	Tresca: MATERIAL PROPERTIES NONLINEAR 61 (Elastic: Isotropic, Plastic: Tresca, Hardening: Isotropic Hardening Gradient, Isotropic Plastic Strain or Isotropic Total Strain)
	Drucker-Prager: MATERIAL PROPERTIES NONLINEAR 64 (Elastic: Isotropic, Plastic: Drucker-Prager, Hardening: Granular)
	Mohr-Coulomb: MATERIAL PROPERTIES NONLINEAR 65 (Elastic: Isotropic, Plastic: Mohr-Coulomb, Hardening: Granular with Dilation)
	Optimised Implicit Von Mises: MATERIAL PROPERTIES NONLINEAR 75 (Elastic: Isotropic, Plastic: Von Mises, Hardening: Isotropic & Kinematic)
	Volumetric Crushing: Not applicable
	Stress Potential: STRESS POTENTIAL VON_MISES (Isotropic: von Mises, Modified von Mises)
Creep	CREEP PROPERTIES (Creep)
	AASHTO MATERIAL PROPERTIES NONLINEAR 86 AASHTO (Concrete creep model to AASHTO code of Practice)
	CEB-FIP MATERIAL PROPERTIES NONLINEAR 86 CEB-FIP (Concrete creep model to CEB-FIP Model Code 1990)
	Chinese MATERIAL PROPERTIES NONLINEAR 86 CHINESE (Chinese creep model to Chinese Code of Practice)
	Eurocode MATERIAL PROPERTIES NONLINEAR 86 EUROCODE (Concrete creep model to EUROCODE_2)
	IRC MATERIAL PROPERTIES NONLINEAR 86 IRC (Concrete creep model to Indian IRC code of Practice)

Damage		DAMAGE PROPERTIES SIMO, OLIVER (Damage)
Viscoelastic Shrinkage	Not applicable	SHRINKAGE CEB_FIP_90, EUROCODE_2, GENERAL, USER
Rubber	Not applicable	
Generic Polymer	Not applicable	
Composite	Not applicable	

Loading

Prescribed Value	PDSP, TPDSP	Prescribed variable. U, V, W, θ_x , θ_y , θ_z : at end nodes. U, V, W, θ_1 , θ_2 at mid-side node.
Concentrated Loads	CL	Concentrated loads Px, Py, Pz, Mx, My, Mz at end nodes (global). Px, Py, Pz, M1, M2: at mid-side node (M1 and M2 local).
Element Loads	ELDS	Element loads on nodal line (load type number LTYPE *10 defines the corresponding element load type on beam axis) LTYPE, S1, Px, Py, Pz, Mx, My, Mz LTYPE=11: point loads and moments in local directions. LTYPE=12: point loads and moments in global directions. LTYPE, 0, Wx, Wy, Wz, Mx, My, Mz LTYPE=21: uniformly distributed loads in local directions. LTYPE=22: uniformly distributed loads in global directions. LTYPE=23: uniformly distributed projected loads in global directions. LTYPE, S1, Wx1, Wy1, Wz1, Mx1, My1, Mz1, S2, Wx2, Wy2, Wz2, Mx2, My2, Mz2 LTYPE=31: distributed loads in local directions. LTYPE=32: distributed loads in global directions. LTYPE=33: distributed projected loads in global directions. LTYPE, S1, Wx, Wy, Wz, Mx, My, Mz LTYPE=41: trapezoidal loads in local directions. LTYPE=42: trapezoidal loads in global directions.

		LTYPE=43: trapezoidal projected loads in global directions.
Distributed Loads	UDL	Uniformly distributed loads. W_x, W_y, W_z : for element in local directions.
	FLD, FLDG	Not applicable.
Body Forces	CBF	Constant body forces for element. $X_{cbf}, Y_{cbf}, Z_{cbf}, \Omega_x, \Omega_y, \Omega_z, \alpha_x, \alpha_y, \alpha_z$
	BFP, BFPE	Body force potentials at nodes/for element. $\varphi_1, \varphi_2, \varphi_3, 0, X_{cbf}, Y_{cbf}, Z_{cbf}$
Velocities	VELO	Velocities. V_x, V_y, V_z : at nodes.
Accelerations	ACCE	Accelerations. A_x, A_y, A_z : at nodes.
Viscous Support Loads	VSL	Viscous support loads. VL_x, VL_y, VL_z : at nodes.
Initial Stress/Strains	SSI, SSIE	Initial stresses/strains at nodes/for element. Components: $F_x, M_y, M_z, 0, 0, 0, \varepsilon_x, \psi_y, \psi_z, 0, 0, 0, (\sigma_x, \sigma_{xy}, \sigma_{xz}, \sigma_{yz}, \varepsilon_x, \varepsilon_{xy}, \varepsilon_{xz}, \varepsilon_{yz})$ Bracketed terms repeated for each fibre integration point.
	SSIG	Initial stresses/strains at Gauss points. These stresses/strains are specified in the same manner as SSI and SSIE
Residual Stresses	SSR, SSRE	Residual stresses at nodes/for element. Components: $0, 0, 0, 0, 0, 0, 0, 0, 0, 0, 0, 0, (\sigma_x, \sigma_{xy}, \sigma_{xz}, \sigma_{yz}, \varepsilon_x, \varepsilon_{xy}, \varepsilon_{xz}, \varepsilon_{yz})$ Bracketed terms repeated for each fibre integration point.
	SSRG	Residual stresses at Gauss points. These stresses are specified in the same manner as SSR and SSRE.
Target Stress/Strains	TSSIE, TSSIA	Target stresses/strains at nodes/for element. Components: $F_x, M_y, M_z, 0, 0, 0, \varepsilon_x, \psi_y, \psi_z, 0, 0, 0, (\sigma_x, \sigma_{xy}, \sigma_{xz}, \sigma_{yz}, \varepsilon_x, \varepsilon_{xy}, \varepsilon_{xz}, \varepsilon_{yz})$ Bracketed terms repeated for each fibre integration point.
	TSSIG	Target stresses/strains at Gauss points. These stresses/strains are specified in the same manner as TSSIE and TSSIA
Temperatures	TEMP, TMPE	Temperatures at nodes/for element. $T, 0, dT/dy, dT/dz, T_0, 0, dT_0/dy, dT_0/dz$
Overburden	Not applicable.	
Phreatic Surface	Not	

	applicable.
Field Loads	Not applicable.
Temp Dependent Loads	Not applicable.

LUSAS Output

Solver	Force (default): $F_x, M_y, M_z, T_{xz}, T_{xy}, F_y, F_z$: in local directions. Total torque = $T_{xz} + T_{xy}$. Continuum stresses (Option 172): $\sigma_x, \sigma_{xy}, \sigma_{xz}, \sigma_{yz}$: in local directions. Strain/curvatures (default): $\epsilon_x, \psi_y, \psi_z, \psi_{xz}, \psi_{xy}, \gamma_{yz}$: in local directions (see <i>Notes</i>). Total torsional strain = $\psi_{xy} + \psi_{yz}$. Continuum strains (Option 172): $\epsilon_x, \epsilon_{xy}, \epsilon_{xz}, \epsilon_{yz}$: in local directions. By default element output is with respect to the nodal line. OPTION 418 outputs stress/strain resultants with respect to the beam centroidal axes.
Modeller	See Results Tables (Appendix K) .

Local Axes

- [Standard line element](#) The local xy-plane is defined by the 2 end nodes of the beam and the 4th node. The local y-axis is perpendicular to the x-axis and positive on the side of the element where the 4th node lies. The local y and z-axes form a right-hand set with the local x-axis.

Sign Convention

- [Standard beam element](#)

Formulation

Geometric Nonlinearity

Total Lagrangian	For large displacements, large rotations and small strains.
Updated Lagrangian	Not applicable.
Eulerian	Not applicable.
Co-rotational	Not applicable.

Integration Schemes

Stiffness	Default.	2-point torsion, 2-point bending.
	Fine.	As default.
Mass	Default.	3-point.
	Fine.	As default.

Mass Modelling

- Consistent mass (default).
- Lumped mass.

Options

- 32** Suppress stress output (but not stress resultant).
- 55** Output strains as well as stresses.
- 87** Total Lagrangian geometric nonlinearity.
- 102** Disable load correction stiffness matrix due to centripetal acceleration.
- 105** Lumped mass matrix
- 139** Output inelastic Gauss points only
- 170** Suppress transfer of shape function arrays to disk
- 172** Form the [rigidity matrix](#) by numerical cross section integration.
- 406** Specify CBF, UDL, SSI, SSR and TEMP loads along beam centroidal axes
- 418** Output stress resultants relative to beam centroidal axes for eccentric elements

Notes, Assumptions and Limitations

1. The semiloof beam element formulation is based on a [Kirchhoff](#) hypothesis for thin beams (i.e. shearing deformations are excluded). The variation of axial force, bending and torsion along the length of the element may be considered as linear. Shear forces are constant.
2. Input of loads (OPTION 406), and output of stress/strain resultants (OPTION 418) are with respect to the beam centroidal axes. CL is always input with respect to the nodal line; displacements are output with respect to the nodal line. Fiber stress/strain results are output at their actual location.
3. The torsional constant is estimated from the computed values for I_{yy} and I_{zz} , $J_{xx} = I_{yy} + I_{zz}$.
4. For nonlinear material models, fibre integration is used across the cross-sectional area of the beam. Only axial deformation is considered in the plasticity computations, any torsional deformation is assumed to remain elastic.
5. Computing the [rigidity matrix](#) by integration through the cross-section depth of the beam is necessary for all nonlinear material models (except 29). By

default option 172 is invoked automatically and a 5*5 point [Newton-Cotes integration](#) rule is used.

6. By default, the [rigidity matrix](#) is evaluated explicitly for linear materials. A 3*3 point [Newton-Cotes integration](#) rule may be invoked using option 172. Numerical cross section integration enables top, middle and bottom stress output.
7. Integration of the element stiffness matrix is performed using selective integration, with a 2-point Gauss rule for the axial and flexural strain energy, and a 3-point Gauss rule for the torsional strain energy. The selective integration technique is implemented in a similar manner to the method proposed by Hughes, i.e. the strain-displacement matrix for the bending and axial strains is evaluated at the reduced rule quadrature points and then extrapolated to the sampling locations of the 3-point quadrature rule. The material response is then assessed at the 3-point Gauss rule.

Restrictions

- [Ensure mid-side node centrality](#)
- Avoid excessive element curvature

Recommendations on Use

- The element's primary use is to provide a beam stiffener for the semiloof shell (QSL8) for analysing stiffened shell structures.
- The BSX4 element is more effective for linear analysis of 3D frame structures with curved members and nonlinear analysis of three dimensional beam, frame and arch structures.
- The 2-noded straight beam (BMS21) is the most effective for linear analysis of structures containing straight members of constant cross-section, e.g. space frames.

2D Plane Strain Beam Elements

General

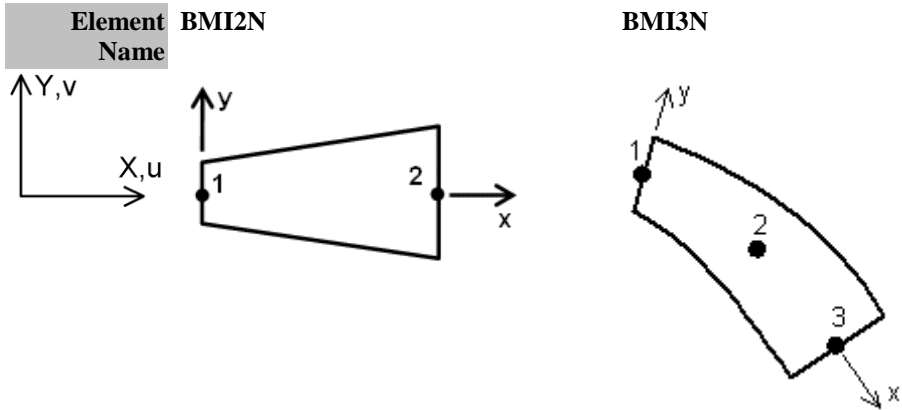

Element Group	Beams
Element Subgroup	Plane Strain Beam
Element Description	Straight and curved isoparametric degenerate thick beam elements in 2D for which shearing deformations are included. The element thickness may vary along its length.
Number Of Nodes	2 (BMI2N) 3 (BMI3N)
Freedom	U, V, θ_z : at each node.
End Releases	The element node numbers should be followed by: R restrained (default) F free defined in the order U, V, θ_z for node 1 and then U, V, θ_z for the other end node (node 2 for BMI2N, node 3 for BMI3N). The releases relate to the local element axes (see Notes, Assumptions and Limitations).
Node Coordinates	X, Y: at each node.

Geometric Properties

t1, t2, t3 Thickness at each node.

Linear Isotropic: MATERIAL PROPERTIES (Elastic: Isotropic)

Matrix Not applicable

Joint Not applicable

Concrete	Not applicable	
Elasto-Plastic	Stress resultant Tresca:	Not applicable. MATERIAL PROPERTIES NONLINEAR 61 (Elastic: Isotropic, Plastic: Tresca, Hardening: Isotropic Hardening Gradient, Isotropic Plastic Strain or Isotropic Total Strain)
	Drucker-Prager:	MATERIAL PROPERTIES NONLINEAR 64 (Elastic: Isotropic, Plastic: Drucker- Prager, Hardening: Granular)
	Mohr-Coulomb:	MATERIAL PROPERTIES NONLINEAR 65 (Elastic: Isotropic, Plastic: Mohr- Coulomb, Hardening: Granular with Dilation)
	Optimised Implicit Von Mises:	MATERIAL PROPERTIES NONLINEAR 75 (Elastic: Isotropic, Plastic: Von Mises, Hardening: Isotropic & Kinematic)
	Volumetric Crushing:	Not applicable.
	Stress Potential	STRESS POTENTIAL VON_MISES, HILL, HOFFMAN (Isotropic: von Mises, Modified von Mises Orthotropic: Hill, Hoffman)
Creep		CREEP PROPERTIES (Creep)
	AASHTO	MATERIAL PROPERTIES NONLINEAR 86 AASHTO (Concrete creep model to AASHTO code of Practice)
	CEB-FIP	MATERIAL PROPERTIES NONLINEAR 86 CEB-FIP (Concrete creep model to CEB-FIP Model Code 1990)
	Chinese	MATERIAL PROPERTIES NONLINEAR 86 CHINESE (Chinese creep model to Chinese Code of Practice)
	Eurocode	MATERIAL PROPERTIES NONLINEAR 86 EUROCODE (Concrete creep model to EUROCODE_2)
	IRC	MATERIAL PROPERTIES NONLINEAR 86 IRC

		(Concrete creep model to Indian IRC code of Practice)
Damage		DAMAGE PROPERTIES SIMO, OLIVER (Damage)
Viscoelastic Shrinkage	Not applicable	SHRINKAGE CEB_FIP_90, EUROCODE_2, GENERAL, USER
Rubber	Not applicable	
Generic Polymer	Not applicable	
Composite	Not applicable	

Loading

Prescribed Value	PDSP, TPDSP	Prescribed variable. U, V, θ_z : at nodes.
Concentrated Loads	CL	Concentrated loads. Px, Py, Mz: at nodes (global).
Element Loads	ELDS	<p>Element loads on nodal line (load type number LTYPE *10 defines the corresponding element load type on beam axis, see Notes)</p> <p>LTYPE, S1, Px, Py, Mz</p> <p>LTYPE=11: point loads and moments in local directions.</p> <p>LTYPE=12: point loads and moments in global directions.</p> <p>LTYPE, 0, Wx, Wy, 0</p> <p>LTYPE=21: uniformly distributed loads in local directions.</p> <p>LTYPE=22: uniformly distributed loads in global directions.</p> <p>LTYPE=23: uniformly distributed projected loads in global directions</p> <p>LTYPE, S1, Wx1, Wy1, 0, S2, Wx2, Wy2, 0</p> <p>LTYPE=31: distributed loads in local directions.</p> <p>LTYPE=32: distributed loads in global directions.</p> <p>LTYPE=33: distributed projected loads in global directions</p> <p>LTYPE, S1, Wx, Wy, 0</p> <p>LTYPE=41: trapezoidal loads in local directions.</p> <p>LTYPE=42: trapezoidal loads in global</p>

		directions.
		LTYPE=43: trapezoidal projected loads in global directions
Distributed Loads	UDL	Uniformly distributed loads. W_x , W_y : forces/unit length for element in local directions.
	FLD	Not applicable.
Body Forces	CBF	Constant body forces for element. X_{cbf} , Y_{cbf} , Ω_x , Ω_y , Ω_z , α_z
	BFP, BFPE	Body force potentials at nodes/for element. ϕ_1 , ϕ_2 , 0, 0, X_{cbf} , Y_{cbf}
Velocities	VELO	Velocities. V_x , V_y : at nodes.
Accelerations	ACCE	Acceleration. A_x , A_y : at nodes.
Viscous Support Loads	VSL	Viscous support loads. VL_x , Vl_y : at nodes.
Initial Stress/Strains	SSI, SSIE	Initial stresses/strains at nodes/for element. Components: N_x , 0, M_x , 0, S_{xy} , ϵ_x , 0, γ_x , 0, ϵ_{xy} , (σ_x , σ_{xy} , σ_z , ϵ_x , ϵ_{xy} , ϵ_z) Bracketed terms repeated for each fibre integration point.
	SSIG	Initial stresses/strains at Gauss points. These stresses/strains are specified in the same manner as SSI and SSIE.
Residual Stresses	SSR, SSRE,	Residual stresses at nodes/for element. Components: 0, 0, 0, 0, 0, 0, 0, 0, 0, 0, (σ_x , σ_{xy} , σ_z) Bracketed terms repeated for each fibre integration point.
	SSRG	Residual stresses at Gauss points for element.. Components: 0, 0, 0, 0, 0, 0, 0, 0, 0, 0, (σ_x , σ_{xy} , σ_z) Bracketed terms repeated for each fibre integration point.
Target Stress/Strains	TSSIE, TSSIA	Target stresses/strains at nodes/for element. F_x , F_y , M_z : axial force, shear force and moment in local directions. ϵ_x , ϵ_y , ψ_z : axial, shear and flexural strains in local directions.
	TSSIG	Target stresses/strains at Gauss points. These stresses/strains are specified in the same manner as TSSIE and TSSIA.
Temperatures	TEMP, TMPE	Temperatures at nodes/for elements. T , 0, dT/dy , 0, T_0 , 0, dT_0/dy , 0 in local

Phreatic surface	Face_Pressure	directions. The fluid pressure is applied in the $-y$ direction of the element y axis..
Field Loads	Not applicable.	
Temp Dependent Loads	Not applicable.	

LUSAS Output

Solver	Force. $N_x, N_z, M_x, M_z, S_{xy}$: axial and normal forces, moments/unit width in local directions, shear force. NB. The plate/shell convention is used for the moment definition. Strain. $\epsilon_x, \epsilon_z, \gamma_x, \gamma_z, \epsilon_{xy}$ axial, normal, flexural and shear strains. Continuum stresses: $\sigma_x, \sigma_{xy}, \sigma_z$ in local directions. Strain: $\epsilon_x, \epsilon_{xy}, \epsilon_z$: Axial, shear and normal strains in local directions.
Modeller	See Results Tables (Appendix K) .

Local Axes

- ❑ The local x -axis lies along the line of the element in the direction in which the nodes are numbered. The local y and z -axes form a right-hand set with the local x -axis such that the y -axis lies in the global XY -plane with the z -axis parallel to the global Z -axis.

Sign Convention

- ❑ Standard shell element. Axial and circumferential moments are positive for tension on element top fibre (the top fibre lies on the positive local y side of the element).

Formulation

Geometric Nonlinearity

Total Lagrangian	For large displacements, small rotations and small strains
Updated Lagrangian	Not applicable.
Eulerian	Not applicable.
Co-rotational	Not applicable.

Integration Schemes

Stiffness Default. 1-point (BMI2N), 2-point (BMI3N).

	Fine.	Same as default.
Mass	Default.	2-point (BMI2N), 3-point (BMI3N).
	Fine.	Same as default.

Note: A 3-point [Newton-Cotes integration](#) rule is also available for BMI3N using OPTION 134. This may be more applicable for infinitesimal strain, elasto-plastic analyses of plane frames with straight members since the first and third quadrature points will coincide with the frame joints. See Appendix I of the Theory Manual.

Mass Modelling

- Consistent mass (default).
- Lumped mass.

Options

- 36** Follower loads
- 55** Output strains as well as stresses.
- 87** Total Lagrangian geometric nonlinearity.
- 102** Switch off load correction stiffness matrix due to centripetal acceleration
- 105** Lumped mass matrix.
- 134** Gauss to [Newton-Cotes](#) in plane (in the local x direction) integration for elements
- 139** Output yielded integration points only.
- 403** Introduce residual bending flexibility correction for 2-node thick beam BMI21, see Notes, Assumptions and Limitations.
- 404** Compute equivalent nodal loading from equilibrium considerations for 2-node thick beam BMI21, see Notes, Assumptions and Limitations.

Notes, Assumptions and Limitations

1. The element is formulated from the degenerate continuum concept, i.e. enforcing directly the modified Timoshenko hypothesis for thick beams to the continuum theory. Plane cross-sections initially normal to the beam axis remain plane and undistorted (the shape of the cross-section remains unchanged) under deformation, but do not necessarily remain normal to the beam axis. Shearing deformations are included.
2. OPTION 36 is only applicable for use with element load types FLD, ELDS, UDL and phreatic surface pressure. Specifying this option makes these element loads follow the element geometry as the analysis progresses.
3. When OPTION 403 is specified to introduce residual bending flexibility correction (on by default), for BMI2N, the axial force is constant, while the shear force and moment vary linearly along the length of the beam. For BMI3N the axial force, shear force and moment all vary linearly along the length

4. When BMI2N is used together with OPTION 403 to introduce residual bending flexibility correction, its stiffness matrix is enhanced to the order of a cubic. As the plane strain beam can only be of rectangular cross section, a shear area based on 5/6 of the nodal thicknesses is assumed in this process.
5. When BMI2N is used together with OPTION 404, loading that varies along the element length is accounted for in the force diagrams (i.e. for a beam under CBF or internal element loading). A post-processing technique has been introduced to obtain accurate quadratic bending moments for BMI3N. For BMI2N (with OPTION 404) and BMI3, internal forces and moments are output at intervals of 1/10th of the element length by specifying the Gauss point option from the Output button of the LUSAS Datafile dialog.
6. The end releases for this element allow a joint to be modelled between adjacent elements. These joints allow rotation and translation of one beam with respect to another without load transferral. The rotations and translations remain in the local directions of the beam elements and support large deformations.
7. When a nonlinear material is used with this element the transverse shear stresses are excluded from the plasticity computations i.e. the transverse shear stresses are assumed to remain elastic. This means that if a nonlinear material is used in applications where transverse shear tends to dominate the stress field the equivalent von Mises and maximum principal stresses can exceed the uniaxial yield stress.
8. When a step by step dynamic analysis is carried out using BMI elements with distributed loading, the "free body force diagrams" pertaining to applied loading, are not superimposed on the nodal values, to do so would lead to erroneous results until a steady state is reached. It should therefore be noted that different force diagrams will be obtained for BMI elements if static and dynamic analyses are directly compared.
9. OPTION 87 considers large displacements and large rotations using a Total Lagrangian formulation; OPTION 229 considers large displacements and large rotations using a co-rotational formulation. In general the co-rotational formulation works better. When both options 87 and 229 are true, a local Total Lagrangian formulation will be used within a global co-rotational framework.
10. End releases for these elements are currently not valid for use in step-by-step dynamic analyses.

Restrictions

- Ensure mid-side node centrality
- Avoid excessive element curvature

Recommendations on Use

- The element may be used for linear and nonlinear analysis of two dimensional long structures of box girder cross-sections such as tunnel linings and retaining walls for which the plane strain assumption is appropriate.

Chapter 3 : 2D Continuum Elements

2D Plane Stress Continuum Elements

General

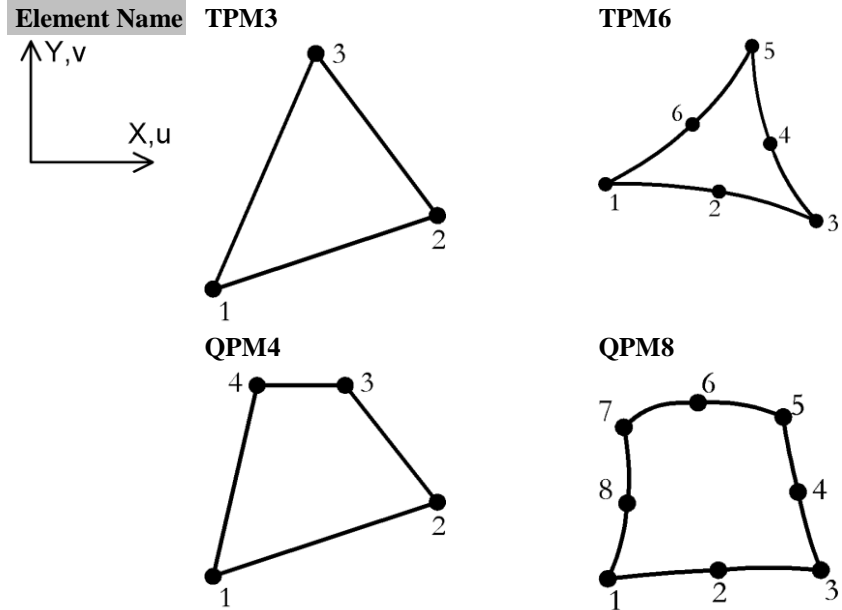

Element Group	2D Continuum
Element Subgroup	Plane Stress Continuum
Element Description	A family of 2D isoparametric elements with the higher order elements capable of modelling curved boundaries. The elements are numerically integrated.
Number Of Nodes	3, 4, 6 or 8, numbered anticlockwise.
Freedom	U, V: at each node.
Node Coordinates	X, Y: at each node.

Geometric Properties

$t_1 \dots t_n$ Thickness at each node.

Material Properties

Linear	Isotropic:	MATERIAL PROPERTIES (Elastic: Isotropic)
	Orthotropic:	MATERIAL PROPERTIES ORTHOTROPIC (Elastic: Orthotropic Plane Stress)
	Anisotropic:	MATERIAL PROPERTIES ANISOTROPIC 3 (Elastic: Anisotropic Thin Plate)
	Rigidities:	RIGIDITIES 3 (Rigidities: Membrane/Thin Plate)
Matrix	Not applicable	
Joint	Not applicable	
Concrete		MATERIAL PROPERTIES NONLINEAR 105 (Elastic: Isotropic, Plastic: Transient Smoothed Multi-Crack Concrete)
		MATERIAL PROPERTIES NONLINEAR 109 (Elastic: Isotropic, Plastic: Smoothed Multi-Crack Concrete)
Elasto-Plastic	Stress resultant:	Not applicable.
	Tresca:	MATERIAL PROPERTIES NONLINEAR 61 (Elastic: Isotropic, Plastic: Tresca, Hardening: Isotropic Hardening Gradient, Isotropic Plastic Strain or Isotropic Total Strain)
	Drucker-Prager:	MATERIAL PROPERTIES NONLINEAR 64 (Elastic: Isotropic, Plastic: Drucker-Prager, Hardening: Granular)
	Mohr-Coulomb:	MATERIAL PROPERTIES NONLINEAR 65 (Elastic: Isotropic, Plastic: Mohr-Coulomb, Hardening: Granular with Dilation)
	Volumetric Crushing:	Not applicable
	Interface:	MATERIAL PROPERTIES NONLINEAR 27
	Stress Potential	STRESS POTENTIAL VON_MISES, HILL, HOFFMAN (Isotropic: von Mises, Modified von Mises Orthotropic: Hill, Hoffman)
Creep		CREEP PROPERTIES (Creep)
	AASHTO	MATERIAL PROPERTIES NONLINEAR 86 AASHTO (Concrete creep model to AASHTO code of Practice)
	CEB-FIP	MATERIAL PROPERTIES NONLINEAR 86

		CEB-FIP (Concrete creep model to CEB-FIP Model Code 1990)
	Chinese	MATERIAL PROPERTIES NONLINEAR 86 CHINESE (Chinese creep model to Chinese Code of Practice)
	Eurocode	MATERIAL PROPERTIES NONLINEAR 86 EUROCODE (Concrete creep model to EUROCODE_2)
	IRC	MATERIAL PROPERTIES NONLINEAR 86 IRC (Concrete creep model to Indian IRC code of Practice)
	Damage	DAMAGE PROPERTIES SIMO, OLIVER (Damage)
	Viscoelastic Shrinkage	Not applicable
	Ko Initialisation	Not applicable
	Rubber	Not applicable
	Generic Polymer	Isotropic
	Composite	Not applicable
		SHRINKAGE CEB_FIP_90, EUROCODE_2, GENERAL, USER
		MATERIAL PROPERTIES NONLINEAR 89 (Generic Polymer Model)

Loading

Prescribed Value	PDSP, TPDSP	Prescribed variable. U, V: at nodes.
Concentrated Loads	CL	Concentrated loads. Px, Py: at nodes.
Element Loads	Not applicable.	
Distributed Loads	UDL	Not applicable.
	FLD	Face Loads . Px, Py: Local Face Axis Pressures At Nodes.
	FLDG	Global Face Loads. σ_x , σ_y , σ_{xy} at nodes
Body Forces	CBF	Constant body forces for element. Xcbf, Ycbf, Ω_x , Ω_y , Ω_z , α_z
	BFP, BFPE	Body force potentials at nodes/for element. 0, 0, 0, ϕ_4 , Xcbf, Ycbf
Velocities	VELO	Velocities. Vx, Vy: at nodes.

Accelerations	ACCE	Accelerations. Ax, Ay: at nodes.
Viscous Support Loads	VSL	Viscous support loads. VLx, VLy: at nodes.
Initial Stress/Strains	SSI, SSIE	Initial stresses/strains at nodes/for element. σ_x , σ_y , σ_{xy} : global stresses. ϵ_x , ϵ_y , γ_{xy} : global strains.
	SSIG	Initial stresses/strains at Gauss points. σ_x , σ_y , σ_{xy} : global stresses. ϵ_x , ϵ_y , γ_{xy} : global strains.
Residual Stresses	SSR, SSRE	Residual stresses at nodes/for element. σ_x , σ_y , σ_{xy} : global stresses.
	SSRG	Residual stresses at Gauss points. σ_x , σ_y , σ_{xy} : global stresses.
Target Stress/Strains	TSSIE, TSSIA	Target stresses/strains at nodes/for element. σ_x , σ_y , σ_{xy} : global stresses. ϵ_x , ϵ_y , γ_{xy} : global strains.
	TSSIG	Target stresses/strains at Gauss points. σ_x , σ_y , σ_{xy} : global stresses. ϵ_x , ϵ_y , γ_{xy} : global strains.
Temperatures	TEMP, TMPE	Temperatures at nodes/for element. T, 0, 0, 0, To, 0, 0, 0
Overburden	Applicable.	
Phreatic Surface	Applicable.	
Field Loads	Not applicable.	
Temp Dependent Loads	Not applicable.	

LUSAS Output

Solver	Stress resultants: Nx, Ny, Nxy, Nmax, Nmin, β , Ns, Ne Stress (default): σ_x , σ_y , σ_{xy} , σ_{max} , σ_{min} , β , σ_s , σ_e (see description of principal stresses) Strain: ϵ_x , ϵ_y , γ_{xy} , ϵ_{max} , ϵ_{min} , β , ϵ_s , ϵ_e
Modeller	See Results Tables (Appendix K) .

Local Axes

Not applicable (global axes are the reference).

Sign Convention

- [Standard 2D continuum element](#)

Formulation

Geometric Nonlinearity

Total Lagrangian	For large displacements and large rotations.
Updated Lagrangian	For large displacements and large rotations.
Eulerian	For large displacement, large rotations and moderately large strains.
Co-rotational	For large displacements and large rotations.

Integration Schemes

Stiffness	Default.	1-point (TPM3), 3-point (TPM6), 2x2 (QPM4, QPM8)
	Fine (see <i>Options</i>).	3x3 (QPM8), 3-point (TPM3).
Mass	Default.	1-point (TPM3), 3-point (TPM6), 2x2 (QPM4, QPM8)
	Fine (see <i>Options</i>).	3x3 (QPM8), 3-point (TPM3).

Mass Modelling

- Consistent mass (default).
- Lumped mass.

Options

- 18** Invokes fine integration rule.
- 34** Output element stress resultants.
- 36** Follower loads (see Notes)
- 54** Updated Lagrangian geometric nonlinearity.
- 55** Output strains as well as stresses.
- 87** Total Lagrangian geometric nonlinearity.
- 91** Invokes fine integration rule for mass matrix.
- 105** Lumped mass matrix.
- 123** Clockwise node numbering.

- 139** Output yielded Gauss points only
- 167** Eulerian geometric nonlinearity.
- 229** Co-rotational geometric nonlinearity

Notes on Use

1. The element formulations are based on the standard isoparametric approach. The variation of stresses within an element can be regarded as constant for the lower order (corner node only) elements, and linear for the higher (mid-side node) elements.
2. All elements pass the [patch test](#).
3. Non-conservative loading is available with these elements when using either Updated Lagrangian or Eulerian geometric nonlinear formulations together with the face loading (FLD).
4. Option 123 will not operate on a mesh with a mixture of clockwise and anti-clockwise elements, it is only applicable if **every** element is numbered **clockwise**. Surface normals should be visualised and if necessary corrected in the pre-processing stage.
5. If applying an initial stress/strain or thermal load that varies across an element, a higher order element (6 or 8 nodes) should be used. A limitation of the standard isoparametric approach when used for lower order elements (3 or 4 nodes) is that only constant stress/strain fields can be imposed correctly.

Restrictions

- [Ensure mid-side node centrality](#)
- [Avoid excessive element curvature](#)
- Avoid excessive aspect ratio

Recommendations on Use

- The 8-noded element with a 2*2 Gauss rule is usually the most effective element, as the under-integration of the stiffness matrix prevents locking, which may occur either when the element is subjected to [parasitic shear](#), or as the material reaches the incompressible limit (elasto-plasticity). The Gauss point stresses are also sampled at the most accurate locations for the element. However, the element does possess one spurious zero energy mode. This mode is very rarely activated in linear analysis, but it may occur in both materially and geometrically nonlinear analyses. Therefore, a careful examination of the solution should be performed, to check for spurious stress oscillations and peculiarities in the deformed configuration.

- The 8-noded element with a 3*3 Gauss rule may be used if a spurious mechanism is excited with the 2*2 Gauss rule.
- The 4-noded element should not be used for analyses where in-plane bending effects are significant as the element tends to lock in [parasitic shear](#) [C1], e.g. if QPM4 elements are employed to model a cantilever subject to a point load, the solution obtained will be over-stiff.

2D Plane Stress Continuum Element with Enhanced Strains

General

Element Name

QPM4M

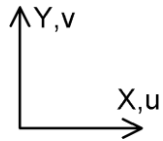

Element Group

2D Continuum

Element Subgroup

Plane Stress Continuum

Element Description

A 2D isoparametric element with an assumed strain field. This mixed assumed strain element demonstrates a superior performance to QPM4 (see Notes). The elements are numerically integrated.

Number Of Nodes

4, numbered anticlockwise.

Freedoms

U, V: at each node.

Node Coordinates

X, Y: at each node.

Geometric Properties

$t_1 \dots t_n$ Thickness at each node.

Material Properties

Linear

Isotropic:

MATERIAL PROPERTIES (Elastic: Isotropic)

Orthotropic:

MATERIAL PROPERTIES ORTHOTROPIC (Elastic: Orthotropic Plane Stress)

Anisotropic:

MATERIAL PROPERTIES ANISOTROPIC 3 (Elastic: Anisotropic Thin Plate)

Rigidities:

RIGIDITIES 3 (Rigidities: Membrane/Thin Plate)

Matrix

Not applicable

Joint

Not applicable

Concrete

MATERIAL PROPERTIES NONLINEAR 105

		(Elastic: Isotropic, Plastic: Transient Smoothed Multi-Crack Concrete)
		MATERIAL PROPERTIES NONLINEAR 109 (Elastic: Isotropic, Plastic: Smoothed Multi-Crack Concrete)
Elasto-Plastic	Stress resultant:	Not applicable
	Tresca:	MATERIAL PROPERTIES NONLINEAR 61 (Elastic: Isotropic, Plastic: Tresca, Hardening: Isotropic Hardening Gradient, Isotropic Plastic Strain or Isotropic Total Strain)
	Drucker-Prager:	MATERIAL PROPERTIES NONLINEAR 64 (Elastic: Isotropic, Plastic: Drucker-Prager, Hardening: Granular)
	Mohr-Coulomb:	MATERIAL PROPERTIES NONLINEAR 65 (Elastic: Isotropic, Plastic: Mohr-Coulomb, Hardening: Granular with Dilation)
	Volumetric Crushing:	Not applicable
	Stress Potential	STRESS POTENTIAL VON_MISES, HILL, HOFFMAN (Isotropic: von Mises, Modified von Mises Orthotropic: Hill, Hoffman)
Creep		CREEP PROPERTIES (Creep)
	AASHTO	MATERIAL PROPERTIES NONLINEAR 86 AASHTO (Concrete creep model to AASHTO code of Practice)
	CEB-FIP	MATERIAL PROPERTIES NONLINEAR 86 CEB-FIP (Concrete creep model to CEB-FIP Model Code 1990)
	Chinese	MATERIAL PROPERTIES NONLINEAR 86 CHINESE (Chinese creep model to Chinese Code of Practice)
	Eurocode	MATERIAL PROPERTIES NONLINEAR 86 EUROCODE (Concrete creep model to EUROCODE_2)
	IRC	MATERIAL PROPERTIES NONLINEAR 86 IRC (Concrete creep model to Indian IRC code of

		Practice)
Damage		DAMAGE PROPERTIES SIMO, OLIVER (Damage)
Viscoelastic Shrinkage	Not applicable	SHRINKAGE CEB_FIP_90, EUROCODE_2, GENERAL, USER
Ko Initialisation	Not applicable	
Rubber	Ogden:	MATERIAL PROPERTIES RUBBER OGDEN (Rubber: Ogden) (Rubber: Ogden)
	Mooney-Rivlin:	MATERIAL PROPERTIES RUBBER MOONEY_RIVLIN (Rubber: Mooney-Rivlin)
	Neo-Hookean:	MATERIAL PROPERTIES RUBBER NEO_HOOKEAN (Rubber: Neo-Hookean)
	Hencky:	MATERIAL PROPERTIES RUBBER HENCKY (Rubber: Hencky)
Generic Polymer	Isotropic	MATERIAL PROPERTIES NONLINEAR 89 (Generic Polymer Model)
Composite	Not applicable	

Loading

Prescribed Value	PDSP, TPDSP	Prescribed variable. U, V: at nodes.
Concentrated Loads	CL	Concentrated loads. Px, Py: at nodes.
Element Loads	Not applicable.	
Distributed Loads	UDL	Not applicable.
	FLD	Face loads . Px, Py: local face axis pressures at nodes.
	FLD	Global Face Loads. σ_x , σ_y , σ_{xy} at nodes
Body Forces	CBF	Constant body forces for element. Xcbf, Ycbf, Ω_x , Ω_y , Ω_z , α_z
	BFP, BFPE	Body force potentials at nodes/for element. 0, 0, 0, ϕ^4 , Xcbf, Ycbf
Velocities	VELO	Velocities. Vx, Vy: at nodes.
Accelerations	ACCE	Accelerations. Ax, Ay: at nodes.
Viscous Support Loads	VSL	Viscous support loads. VLx, VLy: at nodes.
Initial Stress/Strains	SSI, SSIE	Initial stresses/strains at nodes/for element. σ_x , σ_y , σ_{xy} : global stresses. ϵ_x , ϵ_y , γ_{xy} : global strains.

	SSIG	Initial stresses/strains at Gauss points. σ_x , σ_y , σ_{xy} : global stresses. ϵ_x , ϵ_y , γ_{xy} : global strains.
Residual Stresses	SSR, SSRE	Residual stresses at nodes/for element. σ_x , σ_y , σ_{xy} : global stresses.
	SSRG	Residual stresses at Gauss points. σ_x , σ_y , σ_{xy} : global stresses.
Target Stress/Strains	TSSIE, TSSIA	Target stresses/strains at nodes/for element. σ_x , σ_y , σ_{xy} : global stresses. ϵ_x , ϵ_y , γ_{xy} : global strains.
	TSSIG	Target stresses/strains at Gauss points. σ_x , σ_y , σ_{xy} : global stresses. ϵ_x , ϵ_y , γ_{xy} : global strains.
Temperatures	TEMP, TMPE	Temperatures at nodes/for element. T, 0, 0, 0, T_0 , 0, 0, 0
Overburden	Applicable.	
Phreatic Surface	Applicable.	
Field Loads	Not applicable.	
Temp Dependent Loads	Not applicable.	

Output

Solver	Stress resultants: N_x , N_y , N_{xy} , N_{max} , N_{min} , β , N_s , N_e Stress (default): σ_x , σ_y , σ_{xy} , σ_{max} , σ_{min} , β , σ_s , σ_e (see description of principal stresses) Strain: ϵ_x , ϵ_y , γ_{xy} , ϵ_{max} , ϵ_{min} , β , ϵ_s , ϵ_e Stretch (for rubber only): V_{11} , V_{22} , V_{12} , λ_1 , λ_2 , λ_3 , $\theta\lambda$, $\det F$. Where V_{ii} are components of the left stretch tensors, λ_i the principal stretches, $\theta\lambda$ the angle between the maximum principal stretch and the global X axis, and $\det F$ the determinant of the deformation gradient or volume ratio.
Modeller	See Results Tables (Appendix K) .

Local Axes

Not applicable (global axes are the reference).

Sign Convention

- Standard 2D continuum element

Formulation

Geometric Nonlinearity

Total Lagrangian	For large displacements and large rotations.
Updated Lagrangian	For large displacements and large rotations.
Eulerian	For large displacements, large rotations and moderately large strains.
Co-rotational	For large displacements and large rotations (large strains with rubber).

Integration Schemes

Stiffness Default.	2x2
Fine.	As default.
Mass Default.	2x2
Fine.	As default.

Mass Modelling

- Consistent mass (default).
- Lumped mass.

Options

- 34** Output element stress resultants.
- 36** Follower loads.
- 39** Stress smoothing for rubber material models.
- 54** Updated Lagrangian geometric nonlinearity.
- 55** Output strains as well as stresses.
- 87** Total Lagrangian geometric nonlinearity.
- 91** Invokes fine integration rule for mass matrix.
- 105** Lumped mass matrix.
- 123** Clockwise node numbering (see *Notes*).
- 139** Output yielded Gauss points only
- 167** Eulerian geometric nonlinearity.
- 225** Use alternative number of parameters for enhanced strain interpolation (see *Notes*).

229 Co-rotational geometric nonlinearity.

Notes on Use

1. The variation of stresses within an element can be regarded as linear.
2. The element passes the patch test and the large strain patch test for rubber.
3. The strain field for this element consists of two parts: the compatible strains derived from an assumed displacement field and the assumed enhanced strains (see *LUSAS Theory Manual*). The assumed enhanced strain field is defined using 5 or 4 parameters for linear and nonlinear applications respectively. Option 225 switches on the higher 5 parameter enhanced strain interpolation function for nonlinear analysis.
4. Non-conservative loading is available with these elements when using either Updated Lagrangian or Eulerian geometric nonlinear formulations together with the FLD loading facility. The load does not have to be normal to the face and may also vary over the face.
5. To apply a non-conservative (follower) pressure load (load type FLD) with co-rotational geometric nonlinearity, Option 36 must be specified. Note that this load must be normal to the face and constant for all the nodes of the element face.
6. The converged stresses for rubber are Kirchoff stresses (see *LUSAS Theory Manual*).
7. When using the rubber material model, converged strain output is replaced by the left stretch tensor, the principal stretches and the angle defining these principal directions. The value of $\det F = \lambda_1 \lambda_2$ (the Volume ratio) is only available for Gauss-point output. (Refer to the *LUSAS Theory Manual* for more details.)
8. For rubber, the iterative values of stress and strain are output in local co-rotated directions at the Gauss points only.
9. Option 123 will not operate on a mesh with a mixture of clockwise and anti-clockwise elements, it is only applicable if **every** element is numbered **clockwise**. Surface normals should be visualised and if necessary corrected in the pre-processing stage.
10. Using Option 123 with local loading types, such as FLD and UDL, will cause load reversal.
11. Convergence difficulties can sometimes arise when using enhanced strain elements with nonlinear materials, particularly if the material is elastic perfectly plastic or if a very shallow hardening curve is defined. In such cases it is recommended that the standard element formulation is used.

12. In analyses where significant in-plane bending is thermally induced it is recommended that a nonlinear solution is used. If a linear solution is required, then quadratic plane strain elements QPN8 are recommended.

Restrictions

- [Avoid excessive aspect ratio](#)
- Rubber material models can only be applied in conjunction with the co-rotational formulation, Option 229.

Recommendations on Use

These elements exhibit an improved performance when compared with the parent element QPM4. The integration rules are the same as those given for QPM4, but the elements do not suffer from locking due to parasitic shear when the material approaches the incompressible limit. The elements are also free of any zero energy modes.

2D Plane Stress Continuum Crack Tip Elements

General

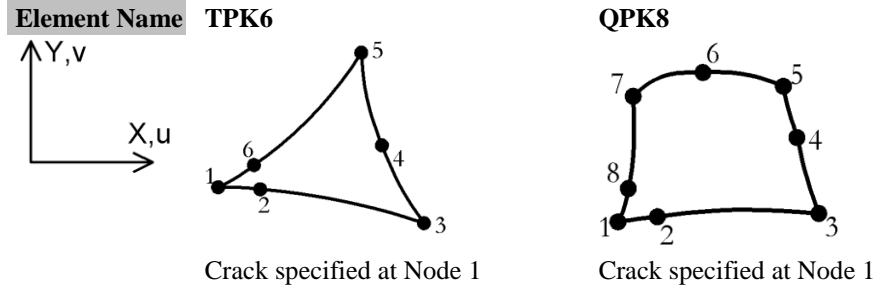

Element Group	2D Continuum
Element Subgroup	Plane Stress Continuum
Element Description	A family of 2D isoparametric crack tip elements where the crack tip can be located at any corner node. The mid-side nodes are moved to the quarter points to produce a singularity at the crack tip. The strains vary as the square root of $1/R$, where R is the distance from the crack tip. These elements are used at the crack tip only and should be mixed with the higher order plane strain continuum elements. The elements are numerically integrated.
Number Of Nodes	6 or 8 numbered anticlockwise.
End Releases	
Freedom Node	U, V: at each node.
Coordinates	X, Y: at each node.

Geometric Properties

$t_1... t_n$ Thickness at each node.

Material Properties

Linear	Isotropic:	MATERIAL PROPERTIES (Elastic: Isotropic)
	Orthotropic	MATERIAL PROPERTIES ORTHOTROPIC (Elastic: Orthotropic Plane Stress)
	Anisotropic:	MATERIAL PROPERTIES ANISOTROPIC 3 (Elastic: Anisotropic Thin Plate)
	Rigidities.	RIGIDITIES 3 (Rigidities: Membrane/Thin Plate)

Matrix	Not applicable	
Joint	Not applicable	
Concrete		MATERIAL PROPERTIES NONLINEAR 109 (Elastic: Isotropic, Plastic: Smoothed Multi-Crack Concrete)
Elasto-Plastic	Stress resultant:	Not applicable.
	Interface:	MATERIAL PROPERTIES NONLINEAR 27
	Tresca:	MATERIAL PROPERTIES NONLINEAR 61 (Elastic: Isotropic, Plastic: Tresca, Hardening: Isotropic Hardening Gradient, Isotropic Plastic Strain or Isotropic Total Strain)
	Drucker-Prager:	MATERIAL PROPERTIES NONLINEAR 64 (Elastic: Isotropic, Plastic: Drucker-Prager, Hardening: Granular)
	Mohr-Coulomb:	MATERIAL PROPERTIES NONLINEAR 65 (Elastic: Isotropic, Plastic: Mohr-Coulomb, Hardening: Granular with Dilatation)
	Volumetric Crushing:	Not applicable.
	Stress Potential	STRESS POTENTIAL VON_MISES, HILL, HOFFMAN (Isotropic: von Mises, Modified von Mises Orthotropic: Hill, Hoffman)
Creep		CREEP PROPERTIES (Creep)
	AASHTO	MATERIAL PROPERTIES NONLINEAR 86 AASHTO (Concrete creep model to AASHTO code of Practice)
	CEB-FIP	MATERIAL PROPERTIES NONLINEAR 86 CEB-FIP (Concrete creep model to CEB-FIP Model Code 1990)
	Chinese	MATERIAL PROPERTIES NONLINEAR 86 CHINESE (Chinese creep model to Chinese Code of Practice)
	Eurocode	MATERIAL PROPERTIES NONLINEAR 86 EUROCODE (Concrete creep model to EUROCODE_2)
	IRC	MATERIAL PROPERTIES NONLINEAR 86 IRC

		(Concrete creep model to Indian IRC code of Practice)
Damage		DAMAGE PROPERTIES SIMO, OLIVER (Damage)
Viscoelastic Shrinkage	Not applicable	SHRINKAGE CEB_FIP_90, EUROCODE_2, GENERAL, USER
Ko Initialisation	Not applicable	
Rubber	Not applicable	
Generic Polymer	Isotropic	MATERIAL PROPERTIES NONLINEAR 89 (Generic Polymer Model)
Composite	Not applicable	

Loading

Prescribed Value	PDSP, TPDSP	Prescribed variable. U, V: at nodes.
Concentrated Loads	CL	Concentrated loads. Px, Py: at nodes.
Element Loads	Not applicable.	
Distributed Loads	UDL	Not applicable.
	FLD	Face loads . Px, Py: local face axis pressures at nodes.
	FLDG	Global Face Loads. σ_x , σ_y , σ_{xy} at nodes
Body Forces	CBF	Constant body forces for element. Xcbf, Ycbf, Ω_x , Ω_y , Ω_z , α_z
	BFP, BFPE	Body force potentials at nodes/for element. 0, 0, 0, φ_4 , Xcbf, Ycbf
Velocities	VELO	Velocities. Vx, Vy: at nodes.
Accelerations	ACCE	Accelerations. Ax, Ay: at nodes.
Viscous Support Loads	VSL	Viscous support loads. VLx, VLy: at nodes.
Initial Stress/Strains	SSI, SSIE	Initial stresses/strains at nodes/for element. σ_x , σ_y , σ_{xy} : global stresses. ϵ_x , ϵ_y , γ_{xy} : global strains.
	SSIG	Initial stresses/strains at Gauss points. σ_x , σ_y , σ_{xy} : global stresses. ϵ_x , ϵ_y , γ_{xy} : global strains.
Residual Stresses	SSR, SSRE	Residual stresses at nodes/for element. σ_x , σ_y , σ_{xy} : global stresses.

	SSRG	Residual stresses at Gauss points. σ_x , σ_y , σ_{xy} : global stresses.
Target Stress/Strains	TSSIE, TSSIA	Target stresses/strains at nodes/for element. σ_x , σ_y , σ_{xy} : global stresses. ϵ_x , ϵ_y , γ_{xy} : global strains.
	TSSIG	Target stresses/strains at Gauss points. σ_x , σ_y , σ_{xy} : global stresses. ϵ_x , ϵ_y , γ_{xy} : global strains.
Temperatures	TEMP, TMPE	Temperatures at nodes/for element. T, 0, 0, 0, T_0 , 0, 0, 0
Overburden	Applicable.	
Phreatic Surface	Applicable.	
Field Loads	Not applicable.	
Temp Dependent Loads	Not applicable.	

LUSAS Output

Solver	Stress resultants: N_x , N_y , N_{xy} , N_{max} , N_{min} , β , N_s , N_e Stress (default): σ_x , σ_y , σ_{xy} , σ_{max} , σ_{min} , β , σ_s , σ_e (see description of principal stresses) Strain: ϵ_x , ϵ_y , γ_{xy} , ϵ_{max} , ϵ_{min} , β , ϵ_s , ϵ_e
Modeller	See Results Tables (Appendix K) .

Local Axes

Not applicable (global axes are the reference).

Sign Convention

- [Standard 2D continuum element](#)

Formulation

Geometric Nonlinearity

Total Lagrangian	For large displacements and large rotations.
Updated Lagrangian	For large displacements and large rotations.
Eulerian	For large displacements, large rotations and moderately large strains.
Co-rotational	For large displacements and large rotations.

Integration Schemes

Stiffness	Default.	6-point (TPK6), 3x3 (QPK8)
	Fine (see <i>Options</i>).	12-point (TPK6).
Mass	Default.	6-point (TPK6), 3x3 (QPK8)
	Fine (see <i>Options</i>).	12-point (TPK6).

Mass Modelling

- Consistent mass (default).
- Lumped mass.

Options

- 18** Invokes finer integration rule.
- 34** Output element stress resultants.
- 54** Updated Lagrangian geometric nonlinearity.
- 55** Output strains as well as stresses.
- 87** Total Lagrangian geometric nonlinearity.
- 91** Invokes fine integration rule for mass matrix.
- 105** Lumped mass matrix.
- 123** Clockwise node numbering.
- 139** Output yielded Gauss points only.
- 167** Eulerian geometric nonlinearity.
- 229** Co-rotational geometric nonlinearity.

Notes on Use

1. The element formulations are based on the standard isoparametric approach. Moving the mid-side nodes to the quarter points creates a singularity with theoretically infinite stress at the corner node.
2. Non-conservative loading is available with these elements when using either Updated Lagrangian or Eulerian geometric nonlinear formulations together with the FLD loading facility.
3. Option 123 will not operate on a mesh with a mixture of clockwise and anti-clockwise elements, it is only applicable if **every** element is numbered **clockwise**. Surface normals should be visualised and if necessary corrected in the pre-processing stage.
4. Using Option 123 with local loading types, such as FLD and UDL, will cause load reversal.

Restrictions

- Avoid excessive element curvature
- Avoid excessive aspect ratio

Recommendations on Use

The QPK8 and TPK6 elements are specifically designed for application to fracture mechanics problems and may be used to model the singularities that occur at the crack tip. The mid-side nodes near the crack tip are shifted to the quarter point. This ensures a singularity is present at the crack tip and that the strains vary as $1/\sqrt{r}$ where r is the distance from the crack tip. The triangular TPK6 element is more effective than the quadrilateral element.

2D Plane Stress Explicit Dynamics Elements

General

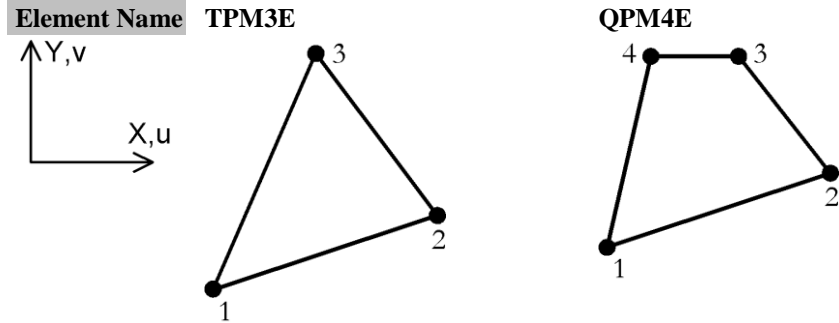

Element Group	2D Continuum
Element Subgroup	Plane Stress Continuum
Element Description	A family of 2D isoparametric elements for explicit dynamic analyses. The elements are numerically integrated.
Number Of Nodes	3 or 4 numbered anticlockwise.
End Releases	
Freedom Node	U, V: at each node. X, Y: at each node.
Coordinates	

Geometric Properties

$t_1... t_n$ Thickness at each node.

Material Properties

Linear	Isotropic:	MATERIAL PROPERTIES (Elastic: Isotropic)
	Orthotropic:	MATERIAL PROPERTIES ORTHOTROPIC (Elastic: Orthotropic Plane Stress)
	Anisotropic:	Not applicable
	Rigidities:	Not applicable
Matrix	Not applicable	
Joint	Not applicable	
Concrete	Not applicable	
Elasto-Plastic	Stress resultant:	Not applicable

Tresca:	MATERIAL PROPERTIES NONLINEAR 61 (Elastic: Isotropic, Plastic: Tresca, Hardening: Isotropic Hardening Gradient, Isotropic Plastic Strain or Isotropic Total Strain)
Drucker-Prager:	MATERIAL PROPERTIES NONLINEAR 64 (Elastic: Isotropic, Plastic: Drucker-Prager, Hardening: Granular)
Mohr-Coulomb:	MATERIAL PROPERTIES NONLINEAR 65 (Elastic: Isotropic, Plastic: Mohr-Coulomb, Hardening: Granular with Dilation)
Volumetric Crushing:	Not applicable
Stress Potential	STRESS POTENTIAL VON_MISES, HILL, HOFFMAN (Isotropic: von Mises, Modified von Mises Orthotropic: Hill, Hoffman)
Creep	Not applicable
Damage	Not applicable
Viscoelastic	Not applicable
Shrinkage	Not applicable
Ko Initialisation	Not applicable
Rubber	Not applicable
Generic Polymer	Not applicable
Composite	Not applicable

Loading

Prescribed Value	PDSP, TPDSP	Prescribed variable. U, V: at each node.
Concentrated Loads	CL	Concentrated loads. Px, Py: at each node.
Element Loads	Not applicable.	
Distributed Loads	UDL FLD FLDG	Not applicable. Face loads . Px, Py: local face axis pressures at nodes. Not applicable.
Body Forces	CBF BFP, BFPE	Constant body forces for element. Xcbf, Ycbf, $\Omega_x, \Omega_y, \Omega_z, \alpha_z$ Body force potentials at nodes/for element. 0, 0, 0, $\phi_4, Xcbf, Ycbf$
Velocities	VELO	Velocities. Vx, Vy: at nodes.
Accelerations	ACCE	Accelerations. Ax, Ay: at nodes.

Viscous Support Loads	VSL	Viscous support loads. V_{Lx} , V_{Ly} : at nodes.
Initial Stress/Strains	SSI, SSIE	Initial stresses/strains at nodes/for element. σ_x , σ_y , σ_{xy} : global stresses. ϵ_x , ϵ_y , γ_{xy} : global strains.
	SSIG	Initial stresses/strains at Gauss points σ_x , σ_y , σ_{xy} : global stresses. ϵ_x , ϵ_y , γ_{xy} : global strains.
Residual Stresses	SSR, SSRE	Residual stresses at nodes/for element. σ_x , σ_y , σ_{xy} : global stresses.
	SSRG	Residual stresses at Gauss points. σ_x , σ_y , σ_{xy} : global stresses.
Target Stress/Strains	Not applicable.	
Temperatures	TEMP, TMPE	Temperatures at nodes/for element. T, 0, 0, 0, T_0 , 0, 0, 0
Overburden	Not applicable.	
Phreatic Surface	Not applicable.	
Field Loads	Not applicable.	
Temp Dependent Loads	Not applicable.	

LUSAS Output

Solver	Stress (default): σ_x , σ_y , σ_{xy} , σ_{max} , σ_{min} , β , σ_s , σ_e (see description of principal stresses) Strain: ϵ_x , ϵ_y , γ_{xy} , ϵ_{max} , ϵ_{min} , β , ϵ_s , ϵ_e
Modeller	See Results Tables (Appendix K) .

Local Axes

Not applicable (global axes are the reference).

Sign Convention

- [Standard 2D continuum element](#)

Formulation

Geometric Nonlinearity

Total Lagrangian	Not applicable.
Updated Lagrangian	Not applicable.
Eulerian	For large displacements, large rotations and moderately large strains.
Co-rotational	For large displacements and large rotations.

Integration Schemes

Stiffness	Default.	1-point (see <i>Notes</i>).
	Fine.	As default.
Mass	Default.	1-point (see <i>Notes</i>).
	Fine.	As default.

Mass Modelling

Lumped mass only (see *Notes*).

Options

34	Output element stress resultants.
55	Output strains as well as stresses.
105	Lumped mass matrix (see <i>Notes</i>).
139	Output yielded Gauss points only.

Notes on Use

1. The element formulations are based on the standard isoparametric approach. The variation of stresses within an element can be regarded as constant.
2. The system parameter HGVISC is used to restrict element mechanisms due to under-integration. The default value is usually sufficient.
3. The bulk viscosity coefficients are used to restrict numerical oscillations due to the traversal of stress waves. The default bulk viscosity coefficients (BULKLF and BULKQF) may be altered as SYSTEM parameters.
4. These elements **must** be used with the dynamic central difference scheme and a lumped mass matrix.
5. These elements are **not** applicable. for static or eigenvalue analyses.
6. Automatic time step calculations are implemented.

7. As the element geometry is always updated in an explicit dynamic analysis, a nonlinear solution is obtained. When using explicit dynamics elements nonlinear control must be specified.
8. If creep properties are defined, explicit time integration must be specified.
9. Non-conservative loading is invoked when the FLD loading facility is applied.
10. Rayleigh damping coefficients are not supported by these elements.
11. Constraint equations are not available for use with these elements.
12. Nodes **must** be specified in an anticlockwise order. Option 123 is **not** applicable for this element. When using Modeller ensure surface normal is in the +ve z direction.

Restrictions

- ❑ [Avoid excessive aspect ratio](#)

Recommendations on Use

Explicit dynamics elements may be used to define surface boundaries which will be active in a slideline analysis.

2D Plane Strain Continuum Elements

General

Element Name

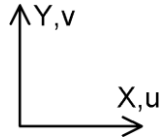

TPN3

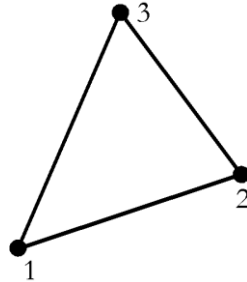

TPN6

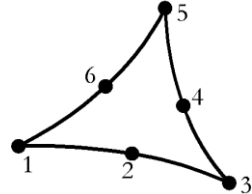

QPN4

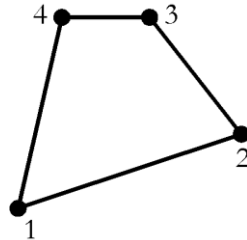

QPN8

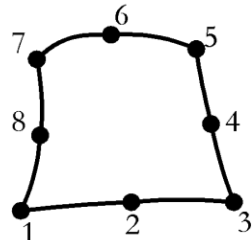

Element Group

2D Continuum

Element

Plane Strain Continuum

Subgroup

Element
Description

A family of 2D isoparametric elements with higher order models capable of modelling curved boundaries. The elements are numerically integrated.

Number Of
Nodes

3, 4, 6, or 8 numbered anticlockwise.

Freedom

U, V: at each node.

Node
Coordinates

X, Y: at each node.

Geometric Properties

Not applicable (a unit thickness is assumed).

Material Properties

Linear

Isotropic:

MATERIAL PROPERTIES (Elastic: Isotropic)

Orthotropic:

MATERIAL PROPERTIES ORTHOTROPIC

		PLANE STRAIN (Elastic: Orthotropic Plane Strain)
	Anisotropic:	MATERIAL PROPERTIES ANISOTROPIC 4 (Not supported in LUSAS Modeller)
	Rigidities.	RIGIDITIES 4 (Not supported in LUSAS Modeller)
Matrix	Not applicable	
Joint	Not applicable	
Concrete		MATERIAL PROPERTIES NONLINEAR 105 (Elastic: Isotropic, Plastic: Transient Smoothed Multi-Crack Concrete)
		MATERIAL PROPERTIES NONLINEAR 109 (Elastic: Isotropic, Plastic: Smoothed Multi-Crack Concrete)
Elasto-Plastic	Stress resultant:	Not applicable.
	Tresca:	MATERIAL PROPERTIES NONLINEAR 61 (Elastic: Isotropic, Plastic: Tresca, Hardening: Isotropic Hardening Gradient, Isotropic Plastic Strain or Isotropic Total Strain)
	Drucker-Prager:	MATERIAL PROPERTIES NONLINEAR 64 (Elastic: Isotropic, Plastic: Drucker-Prager, Hardening: Granular)
	Mohr-Coulomb:	MATERIAL PROPERTIES NONLINEAR 65 (Elastic: Isotropic, Plastic: Mohr-Coulomb, Hardening: Granular with Dilation)
	Modified Mohr-Coulomb:	MATERIAL PROPERTIES MODIFIED MOHR_COULOMB (Elastic: Isotropic, Plastic: Mohr-Coulomb/Tresca, non-associative Hardening with tension/compression cut-off)
	Modified Cam-clay	MATERIAL PROPERTIES CAM_CLAY MODIFIED (Elastic: Isotropic, Plastic)
	Optimised Implicit Von Mises:	MATERIAL PROPERTIES NONLINEAR 75 (Elastic: Isotropic, Plastic: Von Mises, Hardening: Isotropic & Kinematic)
	Volumetric Crushing:	MATERIAL PROPERTIES NONLINEAR 81 (Volumetric Crushing or Crushable Foam)
	Interface:	MATERIAL PROPERTIES NONLINEAR 27
	Stress Potential	STRESS POTENTIAL VON_MISES, HILL, HOFFMAN

		(Isotropic: von Mises, Modified von Mises Orthotropic: Hill, Hoffman)
Creep		CREEP PROPERTIES (Creep)
	AASHTO	MATERIAL PROPERTIES NONLINEAR 86 AASHTO (Concrete creep model to AASHTO code of Practice)
	CEB-FIP	MATERIAL PROPERTIES NONLINEAR 86 CEB-FIP (Concrete creep model to CEB-FIP Model Code 1990)
	Chinese	MATERIAL PROPERTIES NONLINEAR 86 CHINESE (Chinese creep model to Chinese Code of Practice)
	Eurocode	MATERIAL PROPERTIES NONLINEAR 86 EUROCODE (Concrete creep model to EUROCODE_2)
	IRC	MATERIAL PROPERTIES NONLINEAR 86 IRC (Concrete creep model to Indian IRC code of Practice)
Damage		DAMAGE PROPERTIES SIMO, OLIVER (Damage)
Viscoelastic Shrinkage		VISCO ELASTIC PROPERTIES SHRINKAGE CEB_FIP_90, EUROCODE_2, GENERAL, USER
Ko Initialisation	Applicable	
Rubber	Not applicable	
Generic Polymer	Isotropic	MATERIAL PROPERTIES NONLINEAR 89 (Generic Polymer Model)
Composite	Not applicable	
Loading		
Prescribed Value	PDSP, TPDSP	Prescribed variable. U, V: at nodes.
Concentrated Loads	CL	Concentrated loads. Px, Py: at nodes.
Element Loads	Not applicable.	

Distributed Loads	UDL	Not applicable.
	FLD	Face Loads . P_x, P_y : local face axis pressures at nodes.
	FLDG	Global Face Loads. $\sigma_x, \sigma_y, \sigma_{xy}$ at nodes
Body Forces	CBF	Constant body forces for element. $X_{cbf}, Y_{cbf}, 0, 0, \Omega_z, \alpha_z$
	BFP, BFPE	Body force potentials at nodes/for element. $0, 0, 0, \varphi_4, X_{cbf}, Y_{cbf}$
Velocities	VELO	Velocities. V_x, V_y : at nodes.
Accelerations	ACCE	Acceleration A_x, A_y : at nodes.
Viscous Support Loads	VSL	Viscous support loads. VL_x, VL_y : at nodes.
Initial Stress/Strains	SSI, SSIE	Initial stresses/strains at nodes/for element. $\sigma_x, \sigma_y, \sigma_{xy}, \sigma_z$: global stresses. $\epsilon_x, \epsilon_y, \gamma_{xy}$: global strains.
	SSIG	Initial stresses/strains at Gauss points. $\sigma_x, \sigma_y, \sigma_{xy}, \sigma_z$: global stresses. $\epsilon_x, \epsilon_y, \gamma_{xy}$: global strains.
Residual Stresses	SSR, SSRE	Residual stresses at nodes/for element. $\sigma_x, \sigma_y, \sigma_{xy}, \sigma_z$: global stresses.
	SSRG	Residual stresses at Gauss points. $\sigma_x, \sigma_y, \sigma_{xy}, \sigma_z$ global stresses.
Target Stress/Strains	TSSIE, TSSIA	Target stresses/strains at nodes/for element. $\sigma_x, \sigma_y, \sigma_{xy}, \sigma_z$: global stresses. $\epsilon_x, \epsilon_y, \gamma_{xy}$: global strains.
	TSSIG	Target stresses/strains at Gauss points. $\sigma_x, \sigma_y, \sigma_{xy}, \sigma_z$: global stresses. $\epsilon_x, \epsilon_y, \gamma_{xy}$: global strains.
Temperatures	TEMP, TMPE	Temperatures at nodes/for element. $T, 0, 0, 0, T_0, 0, 0, 0$
Overburden	Applicable.	
Phreatic Surface	Applicable.	
Field Loads	Not applicable.	
Temp Dependent Loads	Not applicable.	

LUSAS Output

Solver	Stress (default): σ_x , σ_y , σ_{xy} , σ_z , σ_{max} , σ_{min} , β , σ_s , σ_e (see description of principal stresses)
	Strain: ϵ_x , ϵ_y , γ_{xy} , $\epsilon_z = 0$, ϵ_{max} , ϵ_{min} , β , ϵ_s , ϵ_e
Modeller	See Results Tables (Appendix K) .

Local Axes

Not applicable (global axes are the reference).

Sign Convention

- Standard 2D continuum element

Formulation

Geometric Nonlinearity

Total Lagrangian	For large displacements and large rotations.
Updated Lagrangian	For large displacements and large rotations.
Eulerian	For large displacements, large rotations and moderately large strains.
Co-rotational	For large displacements and large rotations.

Integration Schemes

Stiffness	Default.	1-point (TPN3), 3-point (TPN6), 2x2 (QPN4, QPN8)
	Fine (see <i>Options</i>).	3x3 (QPN8), 3-point (TPN3).
Mass	Default.	1-point (TPN3), 3-point (TPN6), 2x2 (QPN4, QPN8)
	Fine (see <i>Options</i>).	3x3 (QPN8), 3-point (TPN3).

Mass Modelling

- Consistent mass (default).
- Lumped mass.

Options

- 18 Invokes finer integration rule.

- 36 Follower loads.
- 54 Updated Lagrangian geometric nonlinearity
- 55 Output strains as well as stresses.
- 87 Total Lagrangian geometric nonlinearity.
- 91 Invokes fine integration rule for mass matrix.
- 105 Lumped mass matrix.
- 123 Clockwise node numbering.
- 139 Output yielded Gauss points only.
- 167 Eulerian geometric nonlinearity.
- 229 Co-rotational geometric nonlinearity

Notes on Use

1. The element formulations are based on the standard isoparametric approach. The variation of stresses within an element can be regarded as constant for the lower order (corner node only) elements, and linear for the higher order (mid-side node) elements.
2. All elements pass the [patch test](#).
3. Non-conservative loading is available with these elements when using either Updated Lagrangian or Eulerian geometric nonlinear formulations together with the FLD loading facility.
4. Option 123 will not operate on a mesh with a mixture of clockwise and anti-clockwise elements, it is only applicable if **every** element is numbered **clockwise**. Surface normals should be visualised and if necessary corrected in the pre-processing stage.
5. Using Option 123 with local loading types, such as FLD and UDL, will cause load reversal.
6. If applying an initial stress/strain or thermal load that varies across an element, a higher order element (6 or 8 nodes) should be used. A limitation of the standard isoparametric approach when used for lower order elements (3 or 4 nodes) is that only constant stress/strain fields can be imposed correctly.

Restrictions

- [Ensure mid-side node centrality](#)
- [Avoid excessive element curvature](#)
- Avoid excessive aspect ratio

Recommendations on Use

- The 8-noded element with a 2*2 Gauss rule is usually the most effective element, as the under-integration of the stiffness matrix prevents locking, which

may occur either when the element is subjected to [parasitic shear](#), or as the material reaches the incompressible limit (elasto-plasticity). The Gauss point stresses are also sampled at the most accurate locations for the element. However, the element does possess one spurious zero energy mode. This mode is very rarely activated in linear analysis, but it may occur in both materially and geometrically nonlinear analyses. Therefore, a careful examination of the solution should be performed, to check for spurious stress oscillations and peculiarities in the deformed configuration.

- The 8-noded element with a 3*3 Gauss rule may be used if a spurious mechanism is excited with the 2*2 Gauss rule.
- The 4-noded element should not be used for analyses where in-plane bending effects are significant as the element tends to lock in [parasitic shear](#), e.g. if QPN4 elements are employed to model a cantilever subject to a point load, the solution obtained will be over-stiff.

2D Plane Strain Continuum Element with Enhanced Strains

General

Element Name

QPN4M

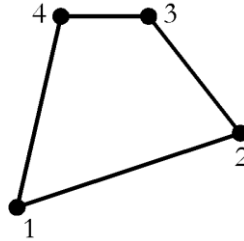
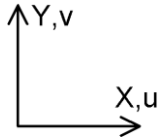

Element Group

2D Continuum

Element Subgroup

Plane Strain Continuum

Element Description

A 2D isoparametric element with an assumed strain field. This mixed assumed strain element demonstrates a superior performance to QPN4 (see Notes). The element is numerically integrated.

Number Of Nodes

4, numbered anticlockwise.

Freedom

U, V: at each node.

Node

X, Y: at each node.

Coordinates

Geometric Properties

Not applicable (a unit thickness is assumed).

Material Properties

Linear	Isotropic:	MATERIAL PROPERTIES (Elastic: Isotropic)
	Orthotropic:	MATERIAL PROPERTIES ORTHOTROPIC PLANE STRAIN (Elastic: Orthotropic Plane Strain)
	Anisotropic:	MATERIAL PROPERTIES ANISOTROPIC 4 (Not supported in LUSAS Modeller)
	Rigidities.	RIGIDITIES 4 (Not supported in LUSAS Modeller)
Matrix	Not applicable	
Joint	Not	

	applicable	
Concrete		MATERIAL PROPERTIES NONLINEAR 105 (Elastic: Isotropic, Plastic: Transient Smoothed Multi-Crack Concrete)
		MATERIAL PROPERTIES NONLINEAR 109 (Elastic: Isotropic, Plastic: Smoothed Multi-Crack Concrete)
Elasto-Plastic	Stress resultant:	Not applicable.
	Tresca:	MATERIAL PROPERTIES NONLINEAR 61 (Elastic: Isotropic, Plastic: Tresca, Hardening: Isotropic Hardening Gradient, Isotropic Plastic Strain or Isotropic Total Strain)
	Drucker-Prager:	MATERIAL PROPERTIES NONLINEAR 64 (Elastic: Isotropic, Plastic: Drucker-Prager, Hardening: Granular)
	Modified Mohr-Coulomb:	MATERIAL PROPERTIES MODIFIED MOHR_COULOMB (Elastic: Isotropic, Plastic: Mohr-Coulomb/Tresca, non-associative Hardening with tension/compression cut-off)
	Modified Cam-clay	MATERIAL PROPERTIES CAM_CLAY MODIFIED (Elastic: Isotropic, Plastic)
	Optimised Implicit Von Mises:	MATERIAL PROPERTIES NONLINEAR 75 (Elastic: Isotropic, Plastic: Von Mises, Hardening: Isotropic & Kinematic)
	Volumetric Crushing:	MATERIAL PROPERTIES NONLINEAR 81 (Volumetric Crushing or Crushable Foam)
	Stress Potential	STRESS POTENTIAL VON_MISES, HILL, HOFFMAN (Isotropic: von Mises, Modified von Mises Orthotropic: Hill, Hoffman)
Creep	AASHTO	MATERIAL PROPERTIES NONLINEAR 86 AASHTO (Concrete creep model to AASHTO code of Practice)
	CEB-FIP	MATERIAL PROPERTIES NONLINEAR 86 CEB-FIP (Concrete creep model to CEB-FIP Model Code 1990)
	Chinese	MATERIAL PROPERTIES NONLINEAR 86 CHINESE

		(Chinese creep model to Chinese Code of Practice)
	Eurocode	MATERIAL PROPERTIES NONLINEAR 86 EUROCODE (Concrete creep model to EUROCODE_2)
	IRC	MATERIAL PROPERTIES NONLINEAR 86 IRC (Concrete creep model to Indian IRC code of Practice)
Damage		DAMAGE PROPERTIES SIMO, OLIVER (Damage)
Viscoelastic Shrinkage		VISCO ELASTIC PROPERTIES SHRINKAGE CEB_FIP_90, EUROCODE_2, GENERAL, USER
Ko Initialisation	Applicable	
Rubber	Ogden	MATERIAL PROPERTIES RUBBER OGDEN (Rubber: Ogden)
	Mooney-Rivlin	MATERIAL PROPERTIES RUBBER MOONEY_RIVLIN (Rubber: Mooney-Rivlin)
	Neo-Hookean	MATERIAL PROPERTIES RUBBER NEO_HOOKEAN (Rubber: Neo-Hookean)
	Hencky	MATERIAL PROPERTIES RUBBER HENCKY (Rubber: Hencky)
Generic Polymer	Isotropic	MATERIAL PROPERTIES NONLINEAR 89 (Generic Polymer Model)
Composite	Not applicable	

Loading

Prescribed Value	PDSP, TPDSP	Prescribed variable. U, V: at nodes.
Concentrated Loads	CL	Concentrated loads. Px, Py: at nodes.
Element Loads	Not applicable.	
Distributed Loads	UDL	Not applicable.
	FLD	Face loads. Px, Py: local face axis pressures at nodes.
	FLDG	Global Face Loads. σ_x , σ_y , σ_{xy} at nodes
Body Forces	CBF	Constant body forces for element. Xcbf, Ycbf, 0, 0, Ω_z , α_z
	BFP, BFPE	Body force potentials at nodes/for element. 0,

		0, 0, φ_4 , Xcbf, Ycbf
Velocities	VELO	Velocities. Vx, Vy: at nodes.
Accelerations	ACCE	Acceleration Ax, Ay: at nodes.
Viscous Support Loads	VSL	Viscous support loads. VLx, VLy: at nodes.
Initial Stress/Strains	SSI, SSIE	Initial stresses/strains at nodes/for element. σ_x , σ_y , σ_{xy} , σ_z : global stresses. ϵ_x , ϵ_y , γ_{xy} : global strains.
	SSIG	Initial stresses/strains at Gauss points. σ_x , σ_y , σ_{xy} , σ_z : global stresses. ϵ_x , ϵ_y , γ_{xy} : global strains.
Residual Stresses	SSR, SSRE	Residual stresses at nodes/for element. σ_x , σ_y , σ_{xy} , σ_z : global stresses.
	SSRG	Residual stresses at Gauss points. σ_x , σ_y , σ_{xy} , σ_z global stresses.
Target Stress/Strains	TSSIE TSSIA	Target stresses/strains at nodes/for element. σ_x , σ_y , σ_{xy} , σ_z : global stresses. ϵ_x , ϵ_y , γ_{xy} : global strains.
	TSSIG	Target stresses/strains at Gauss points. σ_x , σ_y , σ_{xy} , σ_z : global stresses. ϵ_x , ϵ_y , γ_{xy} : global strains.
Temperatures	TEMP, TMPE	Temperatures at nodes/for element. T, 0, 0, 0, To, 0, 0, 0
Overburden	Applicable.	
Phreatic Surface	Applicable.	
Field Loads	Not applicable.	
Temp Dependent Loads	Not applicable.	

LUSAS Output

Solver Stress (default): σ_x , σ_y , σ_{xy} , σ_z , σ_{max} , σ_{min} , β , σ_s , σ_e (see [description of principal stresses](#))

Strain: ϵ_x , ϵ_y , γ_{xy} , $\epsilon_z = 0$, ϵ_{max} , ϵ_{min} , β , ϵ_s , ϵ_e

Stretch (for rubber only): V_{11} , V_{22} , V_{12} , λ_1 , λ_2 , $\lambda_3=1$, $\theta\lambda$, $\det F$.
 Where V_{ii} are components of the left stretch tensors, λ_i the principal stretches, $\theta\lambda$ the angle between the maximum principal

stretch and the global X axis, and $\det F$ the determinant of the deformation gradient or volume ratio.

Modeller See [Results Tables \(Appendix K\)](#).

Local Axes

Not applicable (global axes are the reference).

Sign Convention

- [Standard 2D continuum element](#)

Formulation

Geometric Nonlinearity

Total Lagrangian	For large displacements and large rotations.
Updated Lagrangian	For large displacements and large rotations.
Eulerian	For large displacements, large rotations and moderately large strains.
Co-rotational	For large displacements and large rotations (large strains with rubber).

Integration Schemes

Stiffness	Default.	2x2
	Fine.	As default.
Mass	Default.	2x2
	Fine.	As default.

Mass Modelling

- Consistent mass (default).
- Lumped mass.

Output

- 36** Follower loads.
- 39** Stress smoothing for rubber material models.
- 54** Updated Lagrangian geometric nonlinearity.
- 55** Output strains as well as stresses.
- 87** Total Lagrangian geometric nonlinearity.

- 91 Invokes fine integration rule for mass matrix.
- 105 Lumped mass matrix.
- 123 Clockwise node numbering.
- 139 Output yielded Gauss points only
- 167 Eulerian geometric nonlinearity.
- 225 Use alternative number of parameters for enhanced strain interpolation (see *Notes*).
- 229 Co-rotational geometric nonlinearity.

Notes on Use

1. The variation of stresses within an element can be regarded as linear.
2. The element passes the patch test and the large strain patch test for rubber.
3. The strain field for this element consists of two parts: the compatible strains derived from an assumed displacement field and the assumed enhanced strains; see *LUSAS Theory Manual*. The assumed enhanced strain field is defined using 5 or 4 parameters for linear and nonlinear applications respectively. Option 225 switches on the higher 5 parameter enhanced strain interpolation function for nonlinear analysis.
4. Non-conservative loading is available with these elements when using either Updated Lagrangian or Eulerian geometric nonlinear formulations together with the FLD loading facility. The load does not have to be normal to the face and may also vary over the face.
5. To apply a non-conservative (follower) pressure load (load type FLD) with co-rotational geometric nonlinearity, Option 36 must be specified. Note that this load should be normal to the face and constant for all the nodes of the element face.
6. The converged stresses for rubber are [Kirchhoff](#) stresses (see *LUSAS Theory Manual*).
7. Option 39 is used to smooth the stress output. It is particularly useful when the rubber material model is applied and the element is under very high compression where oscillatory stresses may appear (checker-board pattern).
8. When using the rubber material model, converged strain output is replaced by the left stretch tensor, the principal stretches and the angle defining these principal directions. The value of $\det F = \lambda_1 \lambda_2$ (the Volume ratio) is only available for Gauss-point output. (Refer to the *LUSAS Theory Manual* for more details.)
9. For rubber, the iterative values of stress and strain are output in local co-rotated directions at the Gauss points only.

10. Option 123 will not operate on a mesh with a mixture of clockwise and anti-clockwise elements, it is only applicable if **every** element is numbered **clockwise**. Surface normals should be visualised and if necessary corrected in the pre-processing stage.
11. Using Option 123 with local loading types, such as FLD and UDL, will cause load reversal.
12. Convergence difficulties can sometimes arise when using enhanced strain elements with nonlinear materials, particularly if the material is elastic-perfectly plastic or if a very shallow hardening curve is defined. In such cases it is recommended that the standard element formulation is used.
13. In analyses where significant in-plane bending is thermally induced it is recommended that a nonlinear solution is used. If a linear solution is required, then quadratic plane strain elements QPN8 are recommended.

Restrictions

- Rubber material models can only be applied in conjunction with the co-rotational formulation, Option 229.
- Avoid excessive aspect ratio

Recommendations on Use

These elements exhibit an improved performance when compared with the parent element QPN4. The integration rules are the same as the parent element. The elements do not suffer from locking due to parasitic shear or when the material approaches the incompressible limit. The elements are also free of any zero energy modes.

2D Plane Strain Continuum Element for Large Strains

General

Element Name QPN4L

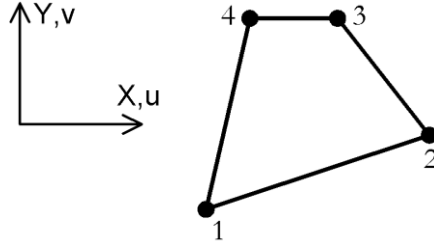

Element Group	2D Continuum
Element Subgroup	Plane Strain Continuum
Element Description	A 2D isoparametric element incorporating an internal pressure variable. This element should be used for analyses involving large strains. The element is numerically integrated
Number Of Nodes	4, numbered anticlockwise.
Freedom Node Coordinates	U, V: at each node. X, Y: at each node.

Geometric Properties

Not applicable (a unit thickness is assumed).

Material Properties

Linear	Not applicable
Matrix	Not applicable
Joint	Not applicable
Concrete	Not applicable
Elasto-Plastic	Implicit Optimised Von Mises Stress
	MATERIAL PROPERTIES NONLINEAR 75 (Elastic: Isotropic, Plastic: Von Mises, Hardening: Isotropic)
	STRESS POTENTIAL VON_MISES (Isotropic)

	Potential	von Mises)
Creep	Not applicable	
Damage	Not applicable	
Viscoelastic	Not applicable	
Shrinkage	Not applicable	
Ko Initialisation	Not applicable	
Rubber	Ogden	MATERIAL PROPERTIES RUBBER OGDEN (Rubber: Ogden)
	Mooney-Rivlin	MATERIAL PROPERTIES RUBBER MOONEY_RIVLIN (Rubber: Mooney-Rivlin)
	Neo-Hookean	MATERIAL PROPERTIES RUBBER NEO_HOOKEAN (Rubber: Neo-Hookean)
	Hencky	MATERIAL PROPERTIES RUBBER HENCKY (Rubber: Hencky)
Generic Polymer	Not applicable	
Composite	Not applicable	

Loading

Prescribed Value	PDSP, TPDSP	Prescribed variable. U, V: at nodes.
Concentrated Loads	CL	Concentrated loads. Px, Py: at nodes.
Element Loads	Not applicable.	
Distributed Loads	UDL	Not applicable.
	FLD	Face loads . Px, Py: local face axis pressures at nodes.
	FLDG	Global Face Loads. σ_x , σ_y , σ_{xy} at nodes
Body Forces	CBF	Constant body forces for element. Xcbf, Ycbf, 0,0, Ω_z , α_z
	BFP, BFPE	Body force potentials at nodes/for element. 0, 0, 0, φ^4 , Xcbf, Ycbf
Velocities	VELO	Velocities. Vx, Vy: at nodes.
Accelerations	ACCE	Acceleration Ax, Ay: at nodes.
Viscous Support	VSL	Viscous support loads. VLx, VLy: at nodes.

Loads		
Initial Stress/Strains	SSI, SSIE	Initial stresses/strains at nodes/for element. σ_x , σ_y , σ_{xy} , σ_z : global stresses. ϵ_x , ϵ_y , γ_{xy} : global strains.
	SSIG	Initial stresses/strains at Gauss points. σ_x , σ_y , σ_{xy} , σ_z : global stresses. ϵ_x , ϵ_y , γ_{xy} : global strains.
Residual Stresses	SSR, SSRE	Residual stresses at nodes/for element. σ_x , σ_y , σ_{xy} , σ_z : global stresses.
	SSRG	Residual stresses at Gauss points. σ_x , σ_y , σ_{xy} , σ_z global stresses.
Target Stress/Strains	TSSIE, TSSIA	Target stresses/strains at nodes/for element. σ_x , σ_y , σ_{xy} , σ_z : global stresses. ϵ_x , ϵ_y , γ_{xy} : global strains.
	TSSIG	Target stresses/strains at Gauss points. σ_x , σ_y , σ_{xy} , σ_z : global stresses. ϵ_x , ϵ_y , γ_{xy} : global strains.
Temperatures	TEMP, TMPE	Temperatures at nodes/for element. T, 0, 0, 0, To, 0, 0, 0
Overburden	Applicable.	
Phreatic Surface	Applicable.	
Field Loads	Not applicable.	
Temp Dependent Loads	Not applicable.	

LUSAS Output

Solver Stress (default): σ_x , σ_y , σ_{xy} , σ_z , σ_{max} , σ_{min} , β , σ_s , σ_e (see [description of principal stresses](#))

Principal stretches, λ_1 , λ_2 , $\lambda_3=1$, $\theta\lambda$, $\det F$. Where V_{ii} are components of the left stretch tensors, λ_i the principal stretches, $\theta\lambda$ the angle between the maximum principal stretch and the global X axis, and $\det F$ the determinant of the deformation gradient or volume ratio.

Modeller See [Results Tables \(Appendix K\)](#).

Local Axes

Not applicable (global axes are the reference).

Sign Convention

- [Standard 2D continuum element](#)

Formulation

Geometric Nonlinearity

Total Lagrangian	Not applicable.
Updated Lagrangian	Not applicable.
Eulerian	For large displacements and large strains.
Co-rotational	For large displacements and large rotations.

Integration Schemes

Stiffness	Default.	2x2
	Fine.	As default.
Mass	Default.	2x2
	Fine.	As default.

Mass Modelling

- Consistent mass (default).
- Lumped mass.

Options

- 55** Output stretches as well as stresses.
- 91** Invokes fine integration rule for mass matrix.
- 105** Lumped mass matrix.
- 123** Clockwise node numbering.

Notes on Use

- The element formulations are based on the standard [isoparametric](#) approach. The variation of stresses within an element can be regarded as linear.
- The element passes the large strain patch test for rubber.
- Non-conservative loading is available with this element when using FLD loading.

4. The stresses output are **Kirchhoff** stresses (see *LUSAS Theory Manual*).
5. Stretch output consists of the principal stretches and the angle defining the principal directions. The value of $\det F = \lambda_1 \lambda_2$ is also output. (Refer to the *LUSAS Theory Manual*.)
6. Option 123 will not operate on a mesh with a mixture of clockwise and anti-clockwise elements, it is only applicable if **every** element is numbered **clockwise**. Surface normals should be visualised and if necessary corrected in the pre-processing stage.
7. Using Option 123 with local loading types, such as FLD and UDL, will cause load reversal.
8. This element is based on a formulation that tackles the problem of volumetric locking in a different way to that used in QPN4M. It should be preferred to the QPN4M in cases where Eulerian description (with a current configuration taken as reference) is more appropriate than the co-rotational description (e.g. inflation problems).

Restrictions

- Avoid excessive aspect ratio
- Avoid non-uniform initial and thermal strains with coarse meshes.

2D Plane Strain Continuum Crack Tip Elements

General

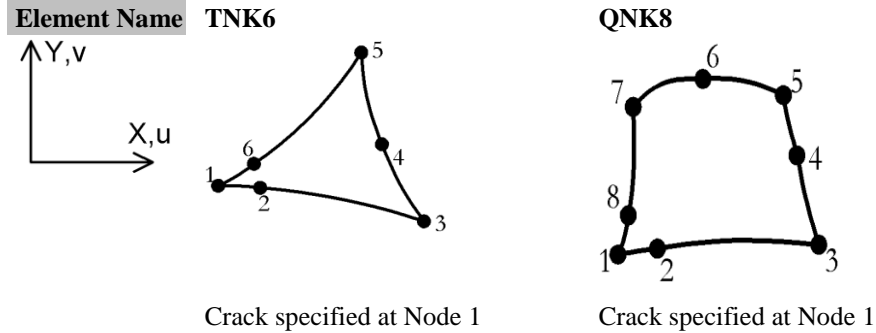

Element Group	2D Continuum
Element Subgroup	Plane Strain Continuum
Element Description	A family of 2D isoparametric crack tip elements where the crack tip can be located at any corner node. The mid-side nodes are moved to the quarter points to produce a singularity at the crack tip. The strains vary as the square root of $1/R$, where R is the distance from the crack tip. These elements are used at the crack tip only and should be mixed with the higher order plane strain continuum elements. The elements are numerically integrated.
Number Of Nodes	6 or 8, numbered anticlockwise.
Freedom Node Coordinates	U, V: at each node. X, Y: at each node.

Geometric Properties

Not applicable (a unit thickness is assumed).

Material Properties

Linear	Isotropic:	MATERIAL PROPERTIES (Elastic: Isotropic)
	Orthotropic:	MATERIAL PROPERTIES ORTHOTROPIC PLANE STRAIN (Elastic: Orthotropic Plane Strain)
	Anisotropic:	MATERIAL PROPERTIES ANISOTROPIC 4 (Not supported in LUSAS Modeller)

	Rigidities.	RIGIDITIES 4 (Not supported in LUSAS Modeller)
Matrix	Not applicable	
Joint	Not applicable	
Concrete		MATERIAL PROPERTIES NONLINEAR 109 (Elastic: Isotropic, Plastic: Smoothed Multi-Crack Concrete)
Elasto-Plastic	Stress resultant:	Not applicable.
	Interface:	MATERIAL PROPERTIES NONLINEAR 27
	Tresca:	MATERIAL PROPERTIES NONLINEAR 61 (Elastic: Isotropic, Plastic: Tresca, Hardening: Isotropic Hardening Gradient, Isotropic Plastic Strain or Isotropic Total Strain)
	Drucker-Prager:	MATERIAL PROPERTIES NONLINEAR 64 (Elastic: Isotropic, Plastic: Drucker-Prager, Hardening: Granular)
	Mohr-Coulomb:	MATERIAL PROPERTIES NONLINEAR 65 (Elastic: Isotropic, Plastic: Mohr-Coulomb, Hardening: Granular with Dilation)
	Modified Mohr-Coulomb:	MATERIAL PROPERTIES MODIFIED MOHR_COULOMB (Elastic: Isotropic, Plastic: Mohr-Coulomb/Tresca, non-associative Hardening with tension/compression cut-off)
	Modified Cam-clay	MATERIAL PROPERTIES CAM_CLAY MODIFIED (Elastic: Isotropic, Plastic)
	Optimised Implicit Von Mises:	MATERIAL PROPERTIES NONLINEAR 75 (Elastic: Isotropic, Plastic: Von Mises, Hardening: Isotropic & Kinematic)
	Volumetric Crushing:	MATERIAL PROPERTIES NONLINEAR 81 (Volumetric Crushing or Crushable Foam)
	Stress Potential	STRESS POTENTIAL VON_MISES, HILL, HOFFMAN (Isotropic: von Mises, Modified von Mises Orthotropic: Hill, Hoffman)
Creep		CREEP PROPERTIES (Creep)

	AASHTO	MATERIAL PROPERTIES NONLINEAR 86 AASHTO (Concrete creep model to AASHTO code of Practice)
	CEB-FIP	MATERIAL PROPERTIES NONLINEAR 86 CEB-FIP (Concrete creep model to CEB-FIP Model Code 1990)
	Chinese	MATERIAL PROPERTIES NONLINEAR 86 CHINESE (Chinese creep model to Chinese Code of Practice)
	Eurocode	MATERIAL PROPERTIES NONLINEAR 86 EUROCODE (Concrete creep model to EUROCODE_2)
	IRC	MATERIAL PROPERTIES NONLINEAR 86 IRC (Concrete creep model to Indian IRC code of Practice)
Damage		DAMAGE PROPERTIES SIMO, OLIVER (Damage)
Viscoelastic		VISCO ELASTIC PROPERTIES
Shrinkage		SHRINKAGE CEB_FIP_90, EUROCODE_2, GENERAL, USER
Ko Initialisation	Applicable	
Rubber	Not applicable	
Generic Polymer	Isotropic	MATERIAL PROPERTIES NONLINEAR 89 (Generic Polymer Model)
Composite	Not applicable	

Loading

Prescribed Value	PDSP, TPDSP	Prescribed variable. U, V: at nodes.
Concentrated Loads	CL	Concentrated loads. Px, Py: at nodes.
Element Loads	Not applicable.	
Distributed Loads	UDL	Not applicable.

	FLD	Face loads. Px, Py: local face axis pressures at nodes.
	FLDG	Global Face Loads. $\sigma_x, \sigma_y, \sigma_{xy}$ at nodes
Body Forces	CBF	Constant body forces for element. Xcbf, Ycbf, 0, 0, Ω_z, α_z
	BFP, BFPE	Body force potentials at nodes/for element. 0, 0, 0, $\phi_4, Xcbf, Ycbf$
Velocities	VELO	Velocities. Vx, Vy: at nodes.
Accelerations	ACCE	Acceleration Ax, Ay: at nodes.
Viscous Support Loads	VSL	Viscous support loads. VLx, VLy: at nodes.
Initial Stress/Strains	SSI, SSIE	Initial stresses/strains at nodes/for element. $\sigma_x, \sigma_y, \sigma_{xy}, \sigma_z$: global stresses. $\epsilon_x, \epsilon_y, \gamma_{xy}$: global strains.
	SSIG	Initial stresses/strains at Gauss points. $\sigma_x, \sigma_y, \sigma_{xy}, \sigma_z$: global stresses. $\epsilon_x, \epsilon_y, \gamma_{xy}$: global strains.
Residual Stresses	SSR, SSRE	Residual stresses at nodes/for element. $\sigma_x, \sigma_y, \sigma_{xy}, \sigma_z$: global stresses.
	SSRG	Residual stresses at Gauss points. $\sigma_x, \sigma_y, \sigma_{xy}, \sigma_z$: global stresses.
Target Stress/Strains	TSSIE, TSSIA	Target stresses/strains at nodes/for element. $\sigma_x, \sigma_y, \sigma_{xy}, \sigma_z$: global stresses. $\epsilon_x, \epsilon_y, \gamma_{xy}$: global strains.
	TSSIG	Target stresses/strains at Gauss points. $\sigma_x, \sigma_y, \sigma_{xy}, \sigma_z$: global stresses. $\epsilon_x, \epsilon_y, \gamma_{xy}$: global strains.
Temperatures	TEMP, TMPE	Temperatures at nodes/for element. T, 0, 0, 0, To, 0, 0, 0
Overburden	Applicable.	
Phreatic Surface	Applicable.	
Field Loads	Not applicable.	
Temp Dependent Loads	Not applicable.	

LUSAS Output

- Solver** Stress (default): σ_x , σ_y , σ_{xy} , σ_{max} , σ_{min} , β , σ_s , σ_e (see [description of principal stresses](#))
- Strain: ϵ_x , ϵ_y , γ_{xy} , ϵ_{max} , ϵ_{min} , β , ϵ_s , ϵ_e
- Modeller** See [Results Tables \(Appendix K\)](#).

Local Axes

Not applicable (global axes are the reference).

Sign Convention

- Standard 2D continuum element

Formulation

Geometric Nonlinearity

- Total Lagrangian** For large displacements and large rotations.
- Updated Lagrangian** For large displacements and large rotations.
- Eulerian** For large displacements, large rotations and moderately large strains.
- Co-rotational** For large displacements and large rotations.

Integration Schemes

- | | | |
|------------------|-----------------------------|----------------------------|
| Stiffness | Default. | 6-point (TNK6), 3x3 (QNK8) |
| | Fine (see <i>Options</i>). | 12-point (TNK6) |
| Mass | Default. | 6-point (TNK6), 3x3 (QNK8) |
| | Fine (see <i>Options</i>). | 12-point (TNK6) |

Mass Modelling

- Consistent mass (default).
- Lumped mass.

Options

- 18** Invokes finer integration rule.
- 54** Updated Lagrangian geometric nonlinearity.
- 55** Output strains as well as stresses.
- 87** Total Lagrangian geometric nonlinearity.

- 91** Invokes fine integration rule for mass matrix.
- 105** Lumped mass matrix.
- 123** Clockwise node numbering.
- 139** Output yielded Gauss points only.
- 167** Eulerian geometric nonlinearity.
- 229** Co-rotational geometric nonlinearity.

Notes on Use

1. The element formulations are based on the standard isoparametric approach. Moving the mid-side nodes to the quarter points creates a singularity with theoretically infinite stress at the corner node.
2. Non-conservative loading is available with these elements when using either Updated Lagrangian or Eulerian geometric nonlinear formulations together with the FLD loading facility.
3. Option 123 will not operate on a mesh with a mixture of clockwise and anti-clockwise elements, it is only applicable if **every** element is numbered **clockwise**. Surface normals should be visualised and if necessary corrected in the pre-processing stage.
4. Using Option 123 with local loading types, such as FLD and UDL, will cause load reversal.

Restrictions

- [Avoid excessive element curvature](#)
- Avoid excessive aspect ratio

Recommendations on Use

Elements QNK8 and TNK6 are specifically designed for application to fracture mechanics problems and may be used to model the singularities that occur at the crack tip. The mid-side nodes near the crack tip are shifted to the quarter point. This ensures a singularity is present at the crack tip and that the strains vary as $1/\sqrt{r}$ where r is the distance from the crack tip. The triangular TNK6 element is more effective than the quadrilateral element.

2D Plane Strain Explicit Dynamics Elements

General

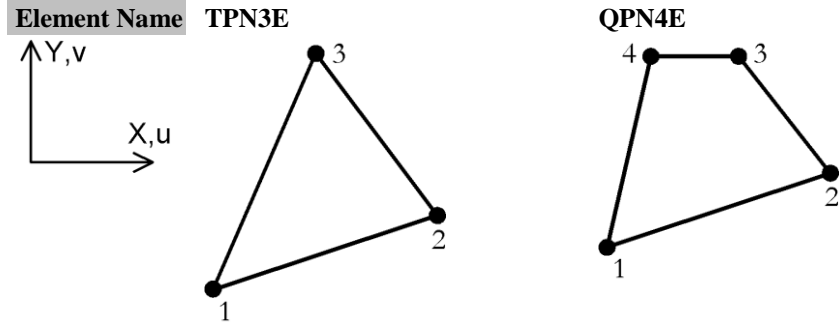

Element Group	2D Continuum
Element Subgroup	Plane Strain Continuum
Element Description	A family of 2D isoparametric elements for explicit dynamic analyses. The elements are numerically integrated.
Number Of Nodes	3 or 4 numbered anticlockwise.
Freedom Node	U, V: at each node.
Coordinates	X, Y: at each node.

Geometric Properties

Not applicable (a unit thickness is assumed).

Material Properties

Linear	Isotropic:	MATERIAL PROPERTIES (Elastic: Isotropic)
	Orthotropic:	MATERIAL PROPERTIES ORTHOTROPIC PLANE STRAIN (Elastic: Orthotropic Plane Strain)
	Anisotropic:	Not applicable.
Matrix	Rigidities:	Not applicable.
	Not applicable	
Joint	Not applicable	
	Not applicable	
Concrete	Not applicable	
	Not applicable	

Elasto-Plastic	Stress resultant:	Not applicable.
	Tresca:	MATERIAL PROPERTIES NONLINEAR 61 (Elastic: Isotropic, Plastic: Tresca, Hardening: Isotropic Hardening Gradient, Isotropic Plastic Strain or Isotropic Total Strain)
	Drucker-Prager:	MATERIAL PROPERTIES NONLINEAR 64 (Elastic: Isotropic, Plastic: Drucker-Prager, Hardening: Granular)
	Mohr-Coulomb:	MATERIAL PROPERTIES NONLINEAR 65 (Elastic: Isotropic, Plastic: Mohr-Coulomb, Hardening: Granular with Dilation)
	Modified Mohr-Coulomb:	MATERIAL PROPERTIES MODIFIED MOHR_COULOMB (Elastic: Isotropic, Plastic: Mohr-Coulomb/Tresca, non-associative Hardening with tension/compression cut-off)
	Optimised Implicit Von Mises:	MATERIAL PROPERTIES NONLINEAR 75 (Elastic: Isotropic, Plastic: Von Mises, Hardening: Isotropic & Kinematic)
	Volumetric Crushing:	MATERIAL PROPERTIES NONLINEAR 81 (Volumetric Crushing or Crushable Foam)
	Stress Potential	STRESS POTENTIAL VON_MISES, HILL, HOFFMAN (Isotropic: von Mises, Modified von Mises Orthotropic: Hill, Hoffman)
	Creep	CREEP PROPERTIES (Creep) (see <i>Notes</i>)
	Damage	DAMAGE PROPERTIES SIMO, OLIVER (Damage)
	Viscoelastic	VISCO ELASTIC PROPERTIES
	Shrinkage	Not applicable
	Ko Initialisation	Not applicable
	Rubber	Not applicable
	Generic Polymer	Not applicable
	Composite	Not applicable

Loading

Prescribed Value PDSP, Prescribed variable. U, V: at each node.

	TPDSP	
Concentrated Loads	CL	Concentrated loads. Px, Py: at each node.
Element Loads	Not applicable.	
Distributed Loads	UDL	Not applicable.
	FLD	Face loads. Px, Py: local face axis pressures at nodes.
	FLDG	Not applicable
Body Forces	CBF	Constant body forces for element. Xcbf, Ycbf, 0, 0, Ω_z , α_z
	BFP, BFPE	Body force potentials at nodes/for element. 0, 0, 0, ϕ_4 , Xcbf, Ycbf
Velocities	VELO	Velocities. Vx, Vy: at nodes.
Accelerations	ACCE	Acceleration Ax, Ay: at nodes.
Viscous Support Loads	VSL	Viscous support loads. VLx, VLy: at nodes.
Initial Stress/Strains	SSI, SSIE	Initial stresses/strains at nodes/for element. σ_x , σ_y , σ_{xy} , σ_z : global stresses. ϵ_x , ϵ_y , γ_{xy} global strains.
	SSIG	Initial stresses/strains at Gauss points. σ_x , σ_y , σ_{xy} , σ_z : global stresses. ϵ_x , ϵ_y , γ_{xy} : global strains.
Residual Stresses	SSR, SSRE	Residual stresses at nodes/for element. σ_x , σ_y , σ_{xy} , σ_z : global stresses.
	SSRG	Residual stresses at Gauss points. σ_x , σ_y , σ_{xy} , σ_z : global stresses.
Target Stress/Strains	Not applicable.	
Temperatures	TEMP, TMPE	Temperatures at nodes/for element. T, 0, 0, 0, To, 0, 0, 0
Overburden	Not applicable.	
Phreatic Surface	Not applicable.	
Field Loads	Not applicable.	
Temp Dependent Loads	Not applicable.	

LUSAS Output

Solver	Stress (default): σ_x , σ_y , σ_{xy} , σ_z , σ_{\max} , σ_{\min} , β , σ_s , σ_e (see description of principal stresses)
	Strain: ϵ_x , ϵ_y , γ_{xy} , ϵ_{\max} , ϵ_{\min} , β , ϵ_s , ϵ_e
Modeller	See Results Tables (Appendix K) .

Local Axes

Not applicable (global axes are the reference).

Sign Convention

- Standard 2D continuum element

Formulation

Geometric Nonlinearity

Total Lagrangian	Not applicable.
Updated Lagrangian	Not applicable.
Eulerian	For large displacements, large rotations and moderately large strains.
Co-rotational	For large displacements and large rotations.

Integration Schemes

Stiffness	Default.	1-point (see <i>Notes</i>).
	Fine.	As default.
Mass	Default.	1-point (see <i>Notes</i>).
	Fine.	As default.

Mass Modelling

- Lumped mass only (see *Notes*).

Options

55	Output strains as well as stresses.
105	Lumped mass matrix (see <i>Notes</i>).
139	Output yielded Gauss points only.

Notes on Use

1. The element formulations are based on the standard
2. The system parameter HGVISC is used to restrict element mechanisms due to under-integration. The default value is usually sufficient.
3. The bulk viscosity coefficients are used to restrict numerical oscillations due to the traversal of stress waves. The default bulk viscosity coefficients (BULKLF and BULKQF) may be altered as SYSTEM parameters.
4. These elements must be used with a dynamic central difference scheme and a lumped mass matrix in order to obtain the maximum efficiency from the numerical algorithms.
5. These elements are not applicable for static or eigenvalue analyses.
6. Automatic time step calculations are implemented.
7. As the element geometry is always updated in an explicit dynamic analysis, a nonlinear solution is obtained. When using explicit dynamics elements NONLINEAR CONTROL must be specified.
8. If CREEP PROPERTIES are defined, explicit time integration must be specified in VISCOUS CONTROL.
9. Non-conservative loading is invoked when the FLD loading facility is applied.
10. Rayleigh damping coefficients are not supported by these elements.
11. Constraint equations are not available for use with these elements.
12. Nodes **must** be specified in an anticlockwise order. Option 123 is **not** applicable for this element. When using Modeller ensure surface normal is in the +ve z direction.

Restrictions

- ❑ [Avoid excessive aspect ratio](#)

Recommendations on Use

Explicit dynamics elements may be used to define surface boundaries which will be active in a slideline analysis.

2D Plane Strain Two Phase Continuum Elements

General

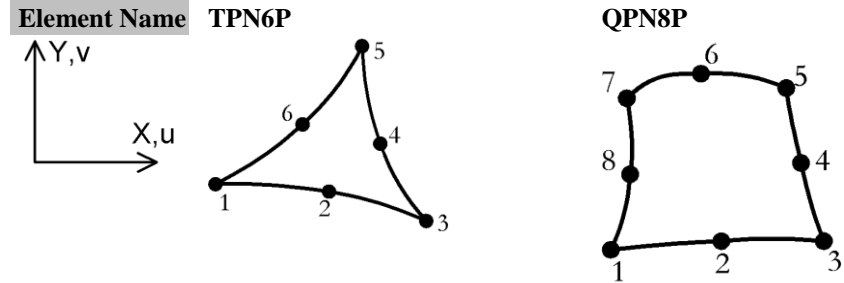

Element Group	2D Continuum
Element Subgroup	Plane Strain Continuum
Element Description	A family of 2D isoparametric elements with higher order models capable of modelling curved boundaries. The elements are numerically integrated.
Number Of Nodes	6 or 8 numbered anticlockwise.
Freedom Node Coordinates	U, V, P at corner nodes. U, V at midside nodes. X, Y: at each node.

Geometric Properties

Not applicable (a unit thickness is assumed).

Material Properties

Linear	Isotropic:	MATERIAL PROPERTIES (Elastic: Isotropic)
	Orthotropic:	MATERIAL PROPERTIES ORTHOTROPIC PLANE STRAIN (Elastic: Orthotropic Plane Strain)
	Anisotropic:	MATERIAL PROPERTIES ANISOTROPIC 4 (Not supported in LUSAS Modeller)
	Rigidities.	RIGIDITIES 4 (Not supported in LUSAS Modeller)
Matrix	Not applicable	
Joint	Not applicable	

Concrete		MATERIAL PROPERTIES NONLINEAR 109 (Elastic: Isotropic, Plastic: Smoothed Multi Crack Concrete)
Elasto-Plastic	Stress resultant:	Not applicable.
	Tresca:	MATERIAL PROPERTIES NONLINEAR 61 (Elastic: Isotropic, Plastic: Tresca, Hardening: Isotropic Hardening Gradient, Isotropic Plastic Strain or Isotropic Total Strain)
	Drucker-Prager:	MATERIAL PROPERTIES NONLINEAR 64 (Elastic: Isotropic, Plastic: Drucker-Prager, Hardening: Granular)
	Mohr-Coulomb:	MATERIAL PROPERTIES NONLINEAR 65 (Elastic: Isotropic, Plastic: Mohr-Coulomb, Hardening: Granular with Dilation)
	Modified Mohr-Coulomb:	MATERIAL PROPERTIES MODIFIED MOHR_COULOMB (Elastic: Isotropic, Plastic: Mohr-Coulomb/Tresca, non-associative Hardening with tension/compression cut-off)
	Modified Cam-clay	MATERIAL PROPERTIES CAM_CLAY MODIFIED (Elastic: Isotropic, Plastic)
	Optimised Implicit Von Mises:	MATERIAL PROPERTIES NONLINEAR 75 (Elastic: Isotropic, Plastic: Von Mises, Hardening: Isotropic & Kinematic)
	Volumetric Crushing:	MATERIAL PROPERTIES NONLINEAR 81 (Volumetric Crushing or Crushable Foam)
	Interface Stress Potential	MATERIAL PROPERTIES NONLINEAR 27 STRESS POTENTIAL VON_MISES, HILL, HOFFMAN (Isotropic: von Mises, Modified von Mises Orthotropic: Hill, Hoffman)
Creep		CREEP PROPERTIES (Creep)
Damage		DAMAGE PROPERTIES SIMO, OLIVER (Damage)
Viscoelastic Shrinkage		VISCOELASTIC PROPERTIES SHRINKAGE CEB_FIP_90, EUROCODE_2, GENERAL, USER
Ko Initialisation	Not applicable	
Rubber	Not applicable	

Generic Polymer Composite Not applicable

MATERIAL PROPERTIES NONLINEAR 89
(Generic Polymer Model)

Loading

Prescribed Value	PDSP, TPDSP	Prescribed variable. U, V, P at corner nodes. U, V at midside nodes.
Concentrated Loads	CL	Concentrated loads. Px, Py, Q at corner nodes. Px, Py at midside nodes.
Element Loads	Not applicable.	
Distributed Loads	UDL FLD	Not applicable. Face Loads. Px, Py, Q: face pressures/flux per unit area at corner nodes relative to local face axes. Px, Py: face pressures at midside nodes relative to local face axes.
Body Forces	FLDG CBF BFP, BFPE	Global Face Loads. $\sigma_x, \sigma_y, \sigma_{xy}$ at nodes Constant body forces for element. Xcbf, Ycbf, 0, 0, $\Omega_z, \alpha_z, g_x, g_y$ (see Notes on Use) Body force potentials at nodes/for element. 0, 0, 0, $\phi_4, Xcbf, Ycbf, g_x, g_y$ (see Notes on Use)
Velocities	VELO	Velocities. Vx, Vy: at nodes.
Accelerations	ACCE	Acceleration Ax, Ay: at nodes.
Viscous Support Loads	VSL	Viscous support loads. VLx, VLy: at nodes.
Initial Stress/Strains	SSI, SSIE SSIG	Initial stresses/strains at nodes/for element. $\sigma_x, \sigma_y, \sigma_{xy}, \sigma_z, \sigma_p$ global stresses. $\epsilon_x, \epsilon_y, \gamma_{xy}$: global strains. Initial stresses/strains at Gauss points. $\sigma_x, \sigma_y, \sigma_{xy}, \sigma_z, \sigma_p$: global stresses. $\epsilon_x, \epsilon_y, \gamma_{xy}$: global strains.
Residual Stresses	SSR, SSRE SSRG	Residual stresses at nodes/for element. $\sigma_x, \sigma_y, \sigma_{xy}, \sigma_z, \sigma_p$: global stresses. Residual stresses at Gauss points. $\sigma_x, \sigma_y, \sigma_{xy}, \sigma_z, \sigma_p$ global stresses.
Target Stress/Strains	TSSIE, TSSIA	Target stresses/strains at nodes/for element. $\sigma_x, \sigma_y, \sigma_{xy}, \sigma_z, \sigma_p$ global stresses. $\epsilon_x, \epsilon_y,$

	TSSIG	γ_{xy} : global strains. Target stresses/strains at Gauss points. σ_x , σ_y , σ_{xy} , σ_z , σ_p : global stresses. ϵ_x , ϵ_y , γ_{xy} : global strains.
Temperatures	TEMP, TMPE	Temperatures at nodes/for element. T, 0, 0, 0, T_0 , 0, 0, 0
Overburden	Applicable.	
Phreatic Surface	Applicable.	
Field Loads	Not applicable.	
Temp Dependent Loads	Not applicable.	

LUSAS Output

Solver	Stress (default): σ_x , σ_y , σ_{xy} , σ_z , σ_p , σ_{max} , σ_{min} , β , σ_s , σ_e (see description of principal stresses) Strain: ϵ_x , ϵ_y , γ_{xy} , $\epsilon_z = 0$, ϵ_v , ϵ_{max} , ϵ_{min} , β , ϵ_s , ϵ_e
Modeller	See Results Tables (Appendix K) .

Local Axes

Not applicable (global axes are the reference).

Sign Convention

- [Standard 2D continuum element](#)

Formulation

Geometric Nonlinearity

Total Lagrangian	For large displacements and large rotations.
Updated Lagrangian	For large displacements and large rotations.
Eulerian	For large displacements, large rotations and moderately large strains.
Co-rotational	For large displacements and large rotations.

Integration Schemes

Stiffness	Default.	3-point (TPN6P), 2x2 (QPN8P)
------------------	----------	------------------------------

	Fine (see <i>Options</i>).	3x3 (QPN8P)
Mass	Default.	3-point (TPN6P), 2x2 (QPN8P)
	Fine (see <i>Options</i>).	3x3 (QPN8P)

Mass Modelling

- Consistent mass (default).
- Lumped mass.

Options

- 18** Invokes finer integration rule.
- 36** Follower loads.
- 54** Updated Lagrangian geometric nonlinearity
- 55** Output strains as well as stresses
- 87** Total Lagrangian geometric nonlinearity.
- 91** Invokes fine integration rule for mass matrix.
- 105** Lumped mass matrix.
- 123** Clockwise node numbering.
- 139** Output yielded Gauss points only.
- 167** Eulerian geometric nonlinearity.
- 229** Co-rotational geometric nonlinearity.

Notes on Use

1. Two phase material parameters must be used with these elements for undrained and consolidation analysis.
2. The element formulations are based on the standard isoparametric approach. The variation of isoparametric stresses and pore pressures within an element can be considered linear.
3. All elements pass the [patch test](#).
4. Option 123 will not operate on a mesh with a mixture of clockwise and anti-clockwise elements, it is only applicable if **every** element is numbered **clockwise**. Surface normals should be visualised and if necessary corrected in the pre-processing stage. Using Option 123 with local loading types, such as FLD and UDL, will cause load reversal.

5. Non-conservative loading is available with these elements when using Updated Lagrangian, Eulerian or co-rotational (with OPTION 36) geometric nonlinear formulations together with the FLD loading facility.
6. The global components of gravity acting on the fluid phase are defined by g_x and g_y under CBF and BFP loading.

Restrictions

- Ensure mid-side node centrality
- Avoid excessive element curvature
- Avoid excessive aspect ratio

2D Axisymmetric Solid Continuum Elements

General

Element Name TAX3

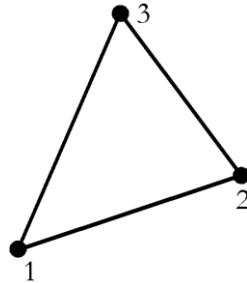
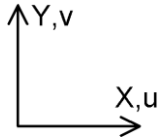

Element Name TAX6

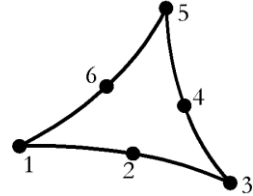

Element Name QAX4

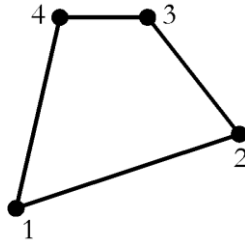

Element Name QAX8

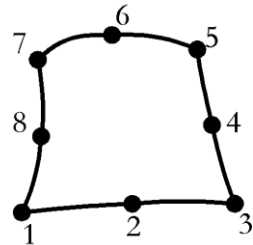

Element Group

2D Continuum

Element

Axisymmetric Solid

Subgroup

Element
Description

A family of 2D [isoparametric](#) elements with higher order models capable of modelling curved boundaries. The formulations apply over a unit radian segment of the structure and the loading and boundary conditions are axisymmetric. By default, the Y-axis is taken as the axis of symmetry. The elements are numerically integrated.

Number Of
Nodes

3, 4, 6, or 8 numbered anticlockwise.

Freedom

U, V; at each node.

Node
Coordinates

X, Y; at each node.

Geometric Properties

Not applicable (a unit radian segment is assumed).

Material Properties

Linear	Isotropic:	MATERIAL PROPERTIES (Elastic: Isotropic)
	Orthotropic:	MATERIAL PROPERTIES ORTHOTROPIC AXISYMMETRIC (Elastic: orthotropic Axisymmetric)
	Anisotropic:	MATERIAL PROPERTIES ANISOTROPIC 4 (Not supported in LUSAS Modeller)
	Rigidities:	Not applicable.
Matrix	Not applicable	
Joint	Not applicable	
Concrete		MATERIAL PROPERTIES NONLINEAR 105 (Elastic: Isotropic, Plastic: Transient Smoothed Multi-Crack Concrete)
		MATERIAL PROPERTIES NONLINEAR 109 (Elastic: Isotropic, Plastic: Smoothed Multi-Crack Concrete)
Elasto-Plastic	Stress resultant:	Not applicable.
	Interface:	MATERIAL PROPERTIES NONLINEAR 27.
	Tresca:	MATERIAL PROPERTIES NONLINEAR 61 (Elastic: Isotropic, Plastic: Tresca, Hardening: Isotropic Hardening Gradient, Isotropic Plastic Strain or Isotropic Total Strain)
	Drucker-Prager:	MATERIAL PROPERTIES NONLINEAR 64 (Elastic: Isotropic, Plastic: Drucker-Prager, Hardening: Granular)
	Mohr-Coulomb:	MATERIAL PROPERTIES NONLINEAR 65 (Elastic: Isotropic, Plastic: Mohr-Coulomb, Hardening: Granular with Dilation)
	Modified Mohr-Coulomb:	MATERIAL PROPERTIES MODIFIED MOHR_COULOMB (Elastic: Isotropic, Plastic: Mohr-Coulomb/Tresca, non-associative Hardening with tension/compression cut-off)
	Modified Cam-clay	MATERIAL PROPERTIES CAM_CLAY MODIFIED (Elastic: Isotropic, Plastic)
	Optimised Implicit Von Mises:	MATERIAL PROPERTIES NONLINEAR 75 (Elastic: Isotropic, Plastic: Von Mises, Hardening: Isotropic & Kinematic)
	Volumetric Crushing:	MATERIAL PROPERTIES NONLINEAR 81 (Volumetric Crushing or Crushable Foam)
	Stress Potential	STRESS POTENTIAL VON_MISES, HILL, HOFFMAN

		(Isotropic: von Mises, Modified von Mises Orthotropic: Hill, Hoffman)
Creep		CREEP PROPERTIES (Creep)
	CEB-FIP	MATERIAL PROPERTIES NONLINEAR 86 CEB-FIP (Concrete creep model to CEB-FIP Model Code 1990)
	AASHTO	MATERIAL PROPERTIES NONLINEAR 86 AASHTO (Concrete creep model to AASHTO code of Practice)
	CEB-FIP	MATERIAL PROPERTIES NONLINEAR 86 CEB-FIP (Concrete creep model to CEB-FIP Model Code 1990)
	Chinese	MATERIAL PROPERTIES NONLINEAR 86 CHINESE (Chinese creep model to Chinese Code of Practice)
	Eurocode	MATERIAL PROPERTIES NONLINEAR 86 EUROCODE (Concrete creep model to EUROCODE_2)
	IRC	MATERIAL PROPERTIES NONLINEAR 86 IRC (Concrete creep model to Indian IRC code of Practice)
Damage		DAMAGE PROPERTIES SIMO, OLIVER (Damage)
Viscoelastic		VISCO ELASTIC PROPERTIES
Shrinkage		SHRINKAGE CEB_FIP_90, EUROCODE_2, GENERAL, USER
Ko Initialisation	Applicable	
Rubber	Not applicable	
Generic	Isotropic	MATERIAL PROPERTIES NONLINEAR 89
Polymer		(Generic Polymer Model)
Composite	Not applicable	
Loading		
Prescribed Value	PDSP, TPDSP	Prescribed variable. U, V: at nodes.
Concentrated	CL	Concentrated loads. Px, Py: force per unit
Loads		radian at nodes.

Element Loads	Not applicable.	
Distributed Loads	UDL	Not available.
	FLD	Face loads. P_x, P_y : local face pressures at nodes (force per unit area).
	FLDG	Global Face Loads. $\sigma_x, \sigma_y, \sigma_{xy}$ at nodes
Body Forces	CBF	Constant body forces for element. $X_{cbf}, Y_{cbf}, \Omega_x, \Omega_y$ (angular velocity must be applied about axis of symmetry), 0, 0.
	BFP, BFPE	Body force potentials at nodes/for element. 0, 0, 0, ϕ_4, X_{cbf}, Y_{cbf}
Velocities	VELO	Velocities. V_x, V_y : at nodes.
Accelerations	ACCE	Acceleration A_x, A_y : at nodes.
Viscous Support Loads	VSL	Viscous support loads. VL_x, VL_y : at nodes.
Initial Stress/Strains	SSI, SSIE	Initial stresses/strains at nodes/for element. $\sigma_x, \sigma_y, \sigma_{xy}, \sigma_z$: global stresses. $\epsilon_x, \epsilon_y, \gamma_{xy}, \epsilon_z$: global strains.
	SSIG	Initial stresses/strains at Gauss points. $\sigma_x, \sigma_y, \sigma_{xy}, \sigma_z$: global stresses. $\epsilon_x, \epsilon_y, \gamma_{xy}, \epsilon_z$: global strains.
Residual Stresses	SSR, SSRE	Residual stresses at nodes/for element. $\sigma_x, \sigma_y, \sigma_{xy}, \sigma_z$: global stresses.
	SSRG	Residual stresses at Gauss points. $\sigma_x, \sigma_y, \sigma_{xy}, \sigma_z$: global stresses.
Target Stress/Strains	TSSIE, TSSIA	Target stresses/strains at nodes/for element. $\sigma_x, \sigma_y, \sigma_{xy}, \sigma_z$: global stresses. $\epsilon_x, \epsilon_y, \gamma_{xy}, \epsilon_z$: global strains.
	TSSIG	Target stresses/strains at Gauss points. $\sigma_x, \sigma_y, \sigma_{xy}, \sigma_z$: global stresses. $\epsilon_x, \epsilon_y, \gamma_{xy}, \epsilon_z$: global strains.
Temperatures	TEMP, TMPE	Temperatures at nodes/for element. T, 0, 0, 0, $T_0, 0, 0, 0$
Overburden	Applicable.	
Phreatic Surface	Applicable.	
Field Loads	Not applicable.	
Temp Dependent	Not	

Loads applicable.

LUSAS Output

Solver	Stress (default): σ_x , σ_y , σ_{xy} , σ_z , σ_{max} , σ_{min} , β , σ_s , σ_e (see description of principal stresses)
	Strain: ϵ_x , ϵ_y , γ_{xy} , ϵ_z , ϵ_{max} , ϵ_{min} , β , ϵ_s , ϵ_e
Modeller	See Results Tables (Appendix K) .

Local Axes

Not applicable (global axes are the reference).

Sign Convention

- Standard 2D continuum element

Formulation

Geometric Nonlinearity

Total Lagrangian	For large displacements and large rotations.
Updated Lagrangian	For large displacements and large rotations.
Eulerian	For large displacements, large rotations and moderately large strains.
Co-rotational	Not applicable.

Integration Schemes

Stiffness	Default.	1-point (TAX3), 3-point (TAX6), 2x2 (QAX4, QAX8)
	Fine (see <i>Options</i>).	3x3 (QAX8), 3-point (TAX3).
Mass	Default.	1-point (TAX3), 3-point (TAX6), 2x2 (QAX4, QAX8)
	Fine (see <i>Options</i>).	3x3 (QAX8), 3-point (TAX3).

Mass Modelling

- Consistent mass (default).
- Lumped mass.

Options

- 18 Invokes finer integration rule.
- 47 X-axis taken as axis of symmetry
- 54 Updated Lagrangian geometric nonlinearity.
- 55 Output strains as well as stresses.
- 87 Total Lagrangian geometric nonlinearity.
- 91 Invokes fine integration rule for mass matrix.
- 105 Lumped mass matrix.
- 123 Clockwise node numbering.
- 139 Output yielded Gauss points only.
- 167 Eulerian geometric nonlinearity.

Notes on Use

1. The element formulations are based on the standard [isoparametric](#) approach. The variation of stresses within an element can be regarded as constant for the lower order (corner node only) elements, and linear for the higher order (mid-side node) elements.
2. All elements pass the [patch test](#).
3. Non-conservative loading is available with these elements when using either Updated Lagrangian or Eulerian geometric nonlinear formulations together with the FLD loading facility.
4. Option 123 will not operate on a mesh with a mixture of clockwise and anti-clockwise elements, it is only applicable if **every** element is numbered **clockwise**. Surface normals should be visualised and if necessary corrected in the pre-processing stage.
5. Using Option 123 with local loading types, such as FLD and UDL, will cause load reversal.
6. The maximum and minimum principal stress computations for axisymmetric elements do not include the σ_z term as this is implicitly a principal stress in a biaxial stress field.
7. An initial stress/strain or thermal load that varies across an element should not be applied to this element. A limitation of the standard isoparametric approach when used for lower order elements is that only constant stress/strain fields can be imposed correctly.

Restrictions

- [Ensure mid-side node centrality](#)
- [Avoid excessive element curvature](#)

- Avoid excessive aspect ratio

Recommendations on Use

- The 8-noded element with a 2*2 Gauss rule is usually the most effective element, as the under-integration of the stiffness matrix prevents locking, which may occur either when the element is subjected to [parasitic shear](#), or as the material reaches the incompressible limit (elasto-plasticity). The Gauss point stresses are also sampled at the most accurate locations for the element. However, the element does possess one spurious zero energy mode. This mode is very rarely activated in linear analysis, but it may occur in both materially and geometrically nonlinear analyses. Therefore, a careful examination of the solution should be performed, to check for spurious stress oscillations and peculiarities in the deformed configuration.
- The 8-noded element with a 3*3 Gauss rule may be used if a spurious mechanism is excited with the 2*2 Gauss rule.
- The 4-noded element should not be used for analyses where in-plane bending effects are significant as the element tends to lock in [parasitic shear](#).

2D Axisymmetric Solid Continuum Element with Enhanced Strains

General

Element Name

QAX4M

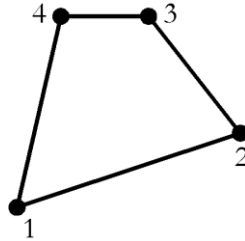
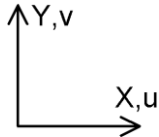

Element Group

2D Continuum

Element Subgroup

Axisymmetric Solid

Element Description

A 2D [isoparametric](#) element with an assumed strain field. This mixed assumed strain element demonstrates a superior performance to QAX4 (see Notes). The formulations apply over a unit radian segment of the structure, and the loading and boundary conditions are axisymmetric. By default, the Y-axis is taken as the axis of symmetry. The element is numerically integrated.

Number Of Nodes

4, numbered anticlockwise.

Freedom

U, V: at each node.

Node

X, Y: at each node.

Coordinates

Geometric Properties

Not applicable (a unit radian segment is assumed).

Material Properties

Linear	Isotropic:	MATERIAL PROPERTIES (Elastic: Isotropic)
	Orthotropic:	MATERIAL PROPERTIES ORTHOTROPIC AXISYMMETRIC (Elastic: Orthotropic Axisymmetric)
	Anisotropic:	MATERIAL PROPERTIES ANISOTROPIC 4 (Not supported in LUSAS Modeller)
	Rigidities:	Not applicable
Matrix	Not	

	applicable	
Joint	Not applicable	
Concrete		MATERIAL PROPERTIES NONLINEAR 105 (Elastic: Isotropic, Plastic: Transient Smoothed Multi-Crack Concrete)
		MATERIAL PROPERTIES NONLINEAR 109 (Elastic: Isotropic, Plastic: Smoothed Multi-Crack Concrete)
Elasto-Plastic	Stress resultant:	Not applicable.
	Tresca:	MATERIAL PROPERTIES NONLINEAR 61 (Elastic: Isotropic, Plastic: Tresca, Hardening: Isotropic Hardening Gradient, Isotropic Plastic Strain or Isotropic Total Strain)
	Drucker-Prager:	MATERIAL PROPERTIES NONLINEAR 64 (Elastic: Isotropic, Plastic: Drucker-Prager, Hardening: Granular)
	Mohr-Coulomb:	MATERIAL PROPERTIES NONLINEAR 65 (Elastic: Isotropic, Plastic: Mohr-Coulomb, Hardening: Granular with Dilation)
	Modified Mohr-Coulomb:	MATERIAL PROPERTIES MODIFIED MOHR_COULOMB (Elastic: Isotropic, Plastic: Mohr-Coulomb/Tresca, non-associative Hardening with tension/compression cut-off)
	Modified Cam-clay	MATERIAL PROPERTIES CAM_CLAY MODIFIED (Elastic: Isotropic, Plastic)
	Optimised Implicit Von Mises:	MATERIAL PROPERTIES NONLINEAR 75 (Elastic: Isotropic, Plastic: Von Mises, Hardening: Isotropic & Kinematic)
	Volumetric Crushing:	MATERIAL PROPERTIES NONLINEAR 81 (Volumetric Crushing or Crushable Foam)
	Stress Potential	STRESS POTENTIAL VON_MISES, HILL, HOFFMAN (Isotropic: von Mises, Modified von Mises Orthotropic: Hill, Hoffman)
Creep		CREEP PROPERTIES (Creep)
	AASHTO	MATERIAL PROPERTIES NONLINEAR 86 AASHTO (Concrete creep model to AASHTO code of Practice)
	CEB-FIP	MATERIAL PROPERTIES NONLINEAR 86

		CEB-FIP (Concrete creep model to CEB-FIP Model Code 1990)
	Chinese	MATERIAL PROPERTIES NONLINEAR 86 CHINESE (Chinese creep model to Chinese Code of Practice)
	Eurocode	MATERIAL PROPERTIES NONLINEAR 86 EUROCODE (Concrete creep model to EUROCODE_2)
	IRC	MATERIAL PROPERTIES NONLINEAR 86 IRC (Concrete creep model to Indian IRC code of Practice)
Damage		DAMAGE PROPERTIES SIMO, OLIVER (Damage)
Viscoelastic		VISCO ELASTIC PROPERTIES
Shrinkage		SHRINKAGE CEB_FIP_90, EUROCODE_2, GENERAL, USER
Ko Initialisation	Applicable	
Rubber	Not applicable	
Generic Polymer	Isotropic	MATERIAL PROPERTIES NONLINEAR 89 (Generic Polymer Model)
Composite	Not applicable	

Loading

Prescribed Value	PDSP, TPDSP	Prescribed variable. U, V: at nodes.
Concentrated Loads	CL	Concentrated loads. Px, Py: force per unit radian at nodes.
Element Loads	Not applicable.	
Distributed Loads	UDL	Not available.
	FLD	Face loads. Px, Py: local face pressures at nodes (force per unit area).
	FLDG	Global Face Loads. σ_x , σ_y , σ_{xy} at nodes
Body Forces	CBF	Constant body forces for element. Xcbf, Ycbf, Ω_x , Ω_y (angular velocity must be applied about axis of symmetry), 0,0.
	BFP, BFPE	Body force potentials at nodes/for element. 0,

		0, 0, φ_4 , Xcbf, Ycbf
Velocities	VELO	Velocities. Vx, Vy: at nodes.
Accelerations	ACCE	Acceleration Ax, Ay: at nodes.
Viscous Support Loads	VSL	Viscous support loads. VLx, VLy: at nodes.
Initial Stress/Strains	SSI, SSIE	Initial stresses/strains at nodes/for element. σ_x , σ_y , σ_{xy} , σ_z : global stresses. ϵ_x , ϵ_y , γ_{xy} , ϵ_z : global strains.
	SSIG	Initial stresses/strains at Gauss points. σ_x , σ_y , σ_{xy} , σ_z : global stresses. ϵ_x , ϵ_y , γ_{xy} , ϵ_z : global strains.
Residual Stresses	SSR, SSRE	Residual stresses at nodes/for element. σ_x , σ_y , σ_{xy} , σ_z : global stresses.
	SSRG	Residual stresses at Gauss points. σ_x , σ_y , σ_{xy} , σ_z : global stresses.
Target Stress/Strains	TSSIE, TSSIA	Target stresses/strains at nodes/for element. σ_x , σ_y , σ_{xy} , σ_z : global stresses. ϵ_x , ϵ_y , γ_{xy} , ϵ_z : global strains.
	TSSIG	Target stresses/strains at Gauss points. σ_x , σ_y , σ_{xy} , σ_z : global stresses. ϵ_x , ϵ_y , γ_{xy} , ϵ_z : global strains.
Temperatures	TEMP, TMPE	Temperatures at nodes/for element. T, 0, 0, 0, To, 0, 0, 0
Overburden	Applicable.	
Phreatic Surface	Applicable.	
Field Loads	Not applicable.	
Temp Dependent Loads	Not applicable.	

LUSAS Output

Solver	Stress (default): σ_x , σ_y , σ_{xy} , σ_z , σ_{max} , σ_{min} , β , σ_s , σ_e (see description of principal stresses)
	Strain: ϵ_x , ϵ_y , γ_{xy} , ϵ_z , ϵ_{max} , ϵ_{min} , β , ϵ_s , ϵ_e
Modeller	See Results Tables (Appendix K) .

Local Axes

Not applicable (global axes are the reference).

Sign Convention

- [Standard 2D continuum element](#)

Formulation

Geometric Nonlinearity

Total Lagrangian	For large displacements and large rotations.
Updated Lagrangian	For large displacements and large rotations.
Eulerian	For large displacements, large rotations and moderately large strains.
Co-rotational	Not applicable.

Integration Schemes

Stiffness Default.	2x2
Fine.	As default.
Mass Default.	2x2
Fine.	As default.

Mass Modelling

- Consistent mass (default).
- Lumped mass.

Options

- 47** X-axis taken as axis of symmetry
- 54** Updated Lagrangian geometric nonlinearity
- 55** Output strains as well as stresses.
- 87** Total Lagrangian geometric nonlinearity.
- 91** Invokes fine integration rule for mass matrix.
- 105** Lumped mass matrix.
- 123** Clockwise node numbering.
- 139** Output yielded Gauss points only.
- 167** Eulerian geometric nonlinearity.

Notes on Use

1. The element formulations are based on the standard [isoparametric](#) approach. The variation of stresses within an element can be regarded as linear.
2. All elements pass the [patch test](#).
3. The strain field for this element consists of two parts: the compatible strains derived from an assumed displacement field and the assumed enhanced strains; see *LUSAS Theory Manual*. The assumed enhanced strain field is defined using 5 parameters for both linear and nonlinear applications.
4. Non-conservative loading is available with these elements when using either Updated Lagrangian or Eulerian geometric nonlinear formulations together with the FLD loading facility.
5. Option 123 will not operate on a mesh with a mixture of clockwise and anti-clockwise elements, it will only work if **every** element is numbered **clockwise**. The best way to avoid a mixture is to check and appropriately reverse the surface definitions in the pre-processing stage of modelling.
6. Using Option 123 with local loading types, such as FLD and UDL, will cause load reversal.
7. The maximum and minimum principal stress computations for axisymmetric elements do not include the σ_z term as this is implicitly a principal stress in a biaxial stress field.
8. Convergence difficulties can sometimes arise when using enhanced strain elements with nonlinear materials, particularly if the material is elastic-perfectly plastic or if a very shallow hardening curve is defined. In such cases it is recommended that the standard element formulation is used.
9. This element exhibits an improved performance when compared with its parent element QAX4. The integration rules are the same as the parent element. The elements do not suffer from locking due to [parasitic shear](#) or when the material approaches the incompressible limit. The elements are also free of any [zero energy modes](#).
10. In analyses where significant in-plane bending is thermally induced it is recommended that a nonlinear solution is used. If a linear solution is required, then quadratic plane strain elements QPN8 are recommended.

Restrictions

- [Avoid excessive aspect ratio](#)

2D Axisymmetric Solid Continuum Element for Large Strains

General

Element Name

QAX4L

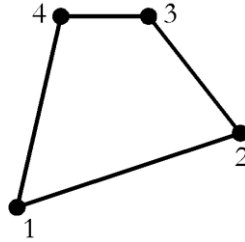
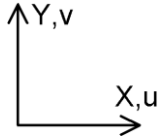

Element Group

2D Continuum

Element Subgroup

Axisymmetric Solid

Element Description

A 2D [isoparametric](#) element incorporating an internal pressure variable. This element should be used for analyses involving large strains. The formulations apply over a unit radian segment of the structure and the loading and boundary conditions are axisymmetric. By default, the Y-axis is taken as the axis of symmetry. The element is numerically integrated.

Number of Nodes

4, numbered anticlockwise.

Freedom

U, V: at each node.

Node Coordinates

X, Y: at each node.

Geometric Properties

Not applicable (a unit radian segment is assumed).

Material Properties

Linear Not applicable

Matrix Not applicable

Joint Not applicable

Concrete Not applicable

Elasto-Plastic	Implicit Optimised Von Mises Stress Potential	MATERIAL PROPERTIES NONLINEAR 75 (Elastic: Isotropic, Plastic: Von Mises, Hardening: Isotropic) STRESS POTENTIAL VON_MISES (Isotropic: von Mises)
Creep	Not applicable	
Damage	Not applicable	
Viscoelastic	Not applicable	
Shrinkage	Not applicable	
Ko Initialisation	Not applicable	
Rubber	Ogden	MATERIAL PROPERTIES RUBBER OGDEN (Rubber: Ogden)
	Mooney- Rivlin	MATERIAL PROPERTIES RUBBER MOONEY_RIVLIN (Rubber: Mooney-Rivlin)
	Neo-Hookean	MATERIAL PROPERTIES RUBBER NEO_HOOKEAN (Rubber: Neo-Hookean)
	Hencky	MATERIAL PROPERTIES RUBBER HENCKY (Rubber: Hencky)
Generic Polymer	Not applicable	
Composite	Not applicable	

Loading

Prescribed Value	PDSP, TPDSP	Prescribed variable. U, V: at nodes.
Concentrated Loads	CL	Concentrated loads. Px, Py: force per unit radian at nodes.
Element Loads	Not applicable.	
Distributed Loads	UDL	Not available.
	FLD	Face loads. Px, Py: local face pressures at nodes (force per unit area).
	FLDG	Global Face Loads. σ_x , σ_y , σ_{xy} at nodes
Body Forces	CBF	Constant body forces for element. Xcbf, Ycbf, Ω_x , Ω_y , (angular velocity must be applied about axis of symmetry), 0,0.
	BFP, BFPE	Body force potentials at nodes/for element. 0, 0, 0, φ_4 , Xcbf, Ycbf

Velocities	VELO	Velocities. V_x, V_y : at nodes.
Accelerations	ACCE	Acceleration A_x, A_y : at nodes.
Viscous Support Loads	VSL	Viscous support loads. VL_x, VL_y : at nodes.
Initial Stress/Strains	SSI, SSIE	Initial stresses/strains at nodes/for element. $\sigma_x, \sigma_y, \sigma_{xy}, \sigma_z$: global stresses. $\epsilon_x, \epsilon_y, \gamma_{xy}, \epsilon_z$: global strains.
	SSIG	Initial stresses/strains at Gauss points. $\sigma_x, \sigma_y, \sigma_{xy}, \sigma_z$: global stresses. $\epsilon_x, \epsilon_y, \gamma_{xy}, \epsilon_z$: global strains.
Residual Stresses	SSR, SSRE	Residual stresses at nodes/for element. $\sigma_x, \sigma_y, \sigma_{xy}, \sigma_z$: global stresses.
	SSRG	Residual stresses at Gauss points. $\sigma_x, \sigma_y, \sigma_{xy}, \sigma_z$: global stresses.
Target Stress/Strains	TSSIE, TSSIA	Target stresses/strains at nodes/for element. $\sigma_x, \sigma_y, \sigma_{xy}, \sigma_z$: global stresses. $\epsilon_x, \epsilon_y, \gamma_{xy}, \epsilon_z$: global strains.
	TSSIG	Target stresses/strains at Gauss points. $\sigma_x, \sigma_y, \sigma_{xy}, \sigma_z$: global stresses. $\epsilon_x, \epsilon_y, \gamma_{xy}, \epsilon_z$: global strains.
Temperatures	TEMP, TMPE	Temperatures at nodes/for element. $T, 0, 0, 0, T_0, 0, 0, 0$
Overburden	Applicable.	
Phreatic Surface	Applicable.	
Field Loads	Not applicable.	
Temp Dependent Loads	Not applicable.	

LUSAS Output

Solver	Stress (default): $\sigma_x, \sigma_y, \sigma_{xy}, \sigma_z, \sigma_{max}, \sigma_{min}, \beta, \sigma_s, \sigma_e$ (see description of principal stresses) Principal stretches, $\lambda_1, \lambda_2, \lambda_{31}, \theta\lambda, \det F$. Where λ_i are the principal stretches, $\theta\lambda$ the angle between the maximum principal stretch and the global X axis, and $\det F$ the determinant of the deformation gradient or volume ratio.
Modeller	See Results Tables (Appendix K) .

Local Axes

Not applicable (global axes are the reference).

Sign Convention

- [Standard 2D continuum element](#)

Formulation

Geometric Nonlinearity

Total Lagrangian	Not applicable.
Updated Lagrangian	Not applicable.
Eulerian	For large displacements and large strains.
Co-rotational	Not applicable.

Integration Schemes

Stiffness	Default.	2x2
	Fine.	As default.
Mass	Default.	2x2
	Fine.	As default.

Mass Modelling

- Consistent mass (default).
- Lumped mass.

Options

- 47** X-axis taken as axis of symmetry.
- 55** Output stretches as well as stresses.
- 91** Invokes fine integration rule for mass matrix.
- 105** Lumped mass matrix
- 123** Clockwise node numbering.

Notes on Use

1. The element formulations are based on the standard [isoparametric](#) approach. The variation of stresses within an element can be regarded as linear.
2. The element passes the large strain patch test for rubber.

3. Non-conservative loading is available with this element when using FLD loading.
4. The stresses output are [Kirchhoff](#) stresses (see *LUSAS Theory Manual*).
5. Stretch output consists of the principal stretches and the angle defining the principal directions. The value of $\det F = \lambda_1 \lambda_2$ is also output. (Refer to the *LUSAS Theory Manual* for more details.)
6. Option 123 will not operate on a mesh with a mixture of clockwise and anti-clockwise elements, it will only work if **every** element is numbered **clockwise**. The best way to avoid a mixture is to check and appropriately reverse the surface definitions in the pre-processing stage of modelling.
7. Using Option 123 with local loading types, such as FLD and UDL, will cause load reversal.
8. The maximum and minimum principal stress computations for axisymmetric elements do not include the σ_z term as this is implicitly a principal stress in a biaxial stress field.

Restrictions

- Avoid excessive aspect ratio
- Avoid non-uniform initial and thermal strains with coarse meshes

2D Axisymmetric Solid Continuum Crack Tip Elements

General

Element Name TXK6

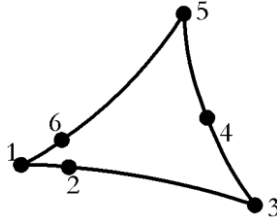
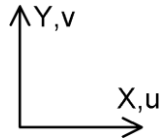

Crack specified at Node 1

Element Name QXK8

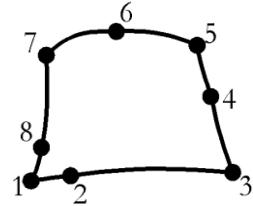

Crack specified at Node 1

Element Group 2D Continuum

Element Axisymmetric Solid

Subgroup

Element Description A family of 2D [isoparametric](#) crack tip elements where the crack tip can be located at any node. The mid-side nodes are moved to the quarter points to produce a singularity at the crack tip. The strains vary as the square root of $1/R$, where R is the distance from the crack tip. These elements are used at the crack tip only and should be mixed with the higher order axisymmetric solid continuum elements. The formulations apply over a unit radian segment of the structure, and the loading and boundary conditions are axisymmetric. By default, the Y-axis is taken as the axis of symmetry. The elements are numerically integrated.

Number Of Nodes 6 or 8 numbered anticlockwise.

Freedom U, V: at each node.

Node Coordinates X, Y: at each node.

Geometric Properties

Not applicable (a unit radian segment is assumed).

Material Properties

Linear Isotropic:	MATERIAL PROPERTIES (Elastic: Isotropic)
Orthotropic:	MATERIAL PROPERTIES ORTHOTROPIC AXISYMMETRIC (Elastic: Orthotropic Axisymmetric)
Anisotropic:	MATERIAL PROPERTIES ANISOTROPIC 4

		(Not supported in LUSAS Modeller)
	Rigidities.	Not applicable.
Matrix	Not applicable	
Joint	Not applicable	
Concrete		MATERIAL PROPERTIES NONLINEAR 109 (Elastic: Isotropic, Plastic: Smoothed Multi-Crack Concrete)
Elasto-Plastic	Stress resultant:	Not applicable.
	Interface:	MATERIAL PROPERTIES NONLINEAR 27
	Tresca:	MATERIAL PROPERTIES NONLINEAR 61 (Elastic: Isotropic, Plastic: Tresca, Hardening: Isotropic Hardening Gradient, Isotropic Plastic Strain or Isotropic Total Strain)
	Drucker-Prager:	MATERIAL PROPERTIES NONLINEAR 64 (Elastic: Isotropic, Plastic: Drucker-Prager, Hardening: Granular)
	Mohr-Coulomb:	MATERIAL PROPERTIES NONLINEAR 65 (Elastic: Isotropic, Plastic: Mohr-Coulomb, Hardening: Granular with Dilation)
	Modified Mohr-Coulomb:	MATERIAL PROPERTIES MODIFIED MOHR_COULOMB (Elastic: Isotropic, Plastic: Mohr-Coulomb/Tresca, non-associative Hardening with tension/compression cut-off)
	Modified Cam-clay	MATERIAL PROPERTIES CAM_CLAY MODIFIED (Elastic: Isotropic, Plastic)
	Optimised Implicit Von Mises:	MATERIAL PROPERTIES NONLINEAR 75 (Elastic: Isotropic, Plastic: Von Mises, Hardening: Isotropic & Kinematic)
	Volumetric Crushing:	MATERIAL PROPERTIES NONLINEAR 81 (Volumetric Crushing or Crushable Foam)
	Stress Potential	STRESS POTENTIAL VON_MISES, HILL, HOFFMAN (Isotropic: von Mises, Modified von Mises Orthotropic: Hill, Hoffman)
Creep		CREEP PROPERTIES (Creep)
	AASHTO	MATERIAL PROPERTIES NONLINEAR 86 AASHTO (Concrete creep model to AASHTO code of Practice)
	CEB-FIP	MATERIAL PROPERTIES NONLINEAR 86

		CEB-FIP (Concrete creep model to CEB-FIP Model Code 1990)
	Chinese	MATERIAL PROPERTIES NONLINEAR 86 CHINESE (Chinese creep model to Chinese Code of Practice)
	Eurocode	MATERIAL PROPERTIES NONLINEAR 86 EUROCODE (Concrete creep model to EUROCODE_2)
	IRC	MATERIAL PROPERTIES NONLINEAR 86 IRC (Concrete creep model to Indian IRC code of Practice)
Damage		DAMAGE PROPERTIES SIMO, OLIVER (Damage)
Viscoelastic		VISCO ELASTIC PROPERTIES
Shrinkage		SHRINKAGE CEB_FIP_90, EUROCODE_2, GENERAL, USER
Shrinkage	Applicable	
Rubber	Not applicable	
Generic Polymer	Isotropic	MATERIAL PROPERTIES NONLINEAR 89 (Generic Polymer Model)
Composite	Not applicable	

Loading

Prescribed Value	PDSP, TPDSP	Prescribed variable. U, V: at nodes.
Concentrated Loads	CL	Concentrated loads. Px, Py: at nodes.
Element Loads	Not applicable.	
Distributed Loads	UDL	Not applicable.
	FLD	Face loads. Px, Py: local face axis pressures at nodes.
	FLDG	Global Face Loads. σ_x , σ_y , σ_{xy} at nodes
Body Forces	CBF	Constant body forces for element. Xcbf, Ycbf, Ω_x , Ω_y (angular velocity must be applied about axis of symmetry), 0, 0.
	BFP, BFPE	Body force potentials at nodes/for element. 0, 0, 0,

		$\varphi_4, X_{cbf}, Y_{cbf}$
Velocities	VELO	Velocities. V_x, V_y : at nodes.
Accelerations	ACCE	Acceleration A_x, A_y : at nodes.
Viscous	VSL	Viscous support loads. VL_x, VL_y : at nodes.
Support Loads		
Initial Stress/Strains	SSI, SSIE	Initial stresses/strains at nodes/for element. $\sigma_x, \sigma_y, \sigma_{xy}, \sigma_z$: global stresses. $\epsilon_x, \epsilon_y, \gamma_{xy}, \epsilon_z$: global strains.
	SSIG	Initial stresses/strains at Gauss points. $\sigma_x, \sigma_y, \sigma_{xy}, \sigma_z$: global stresses. $\epsilon_x, \epsilon_y, \gamma_{xy}, \epsilon_z$: global strains.
Residual Stresses	SSR, SSRE	Residual stresses at nodes/for element. $\sigma_x, \sigma_y, \sigma_{xy}, \sigma_z$: global stresses.
	SSRG	Residual stresses at Gauss points. $\sigma_x, \sigma_y, \sigma_{xy}, \sigma_z$: global stresses.
Target Stress/Strains	TSSIE, TSSIA	Target stresses/strains at nodes/for element. $\sigma_x, \sigma_y, \sigma_{xy}, \sigma_z$: global stresses. $\epsilon_x, \epsilon_y, \gamma_{xy}, \epsilon_z$: global strains.
	TSSIG	Target stresses/strains at Gauss points. $\sigma_x, \sigma_y, \sigma_{xy}, \sigma_z$: global stresses. $\epsilon_x, \epsilon_y, \gamma_{xy}, \epsilon_z$: global strains.
Temperatures	TEMP, TMPE	Temperatures at nodes/for element. $T, 0, 0, 0, T_0, 0, 0, 0$
Overburden	Applicable.	
Phreatic Surface	Applicable.	
Field Loads	Not applicable.	
Temp Dependent Loads	Not applicable.	

LUSAS Output

Solver	Stress (default): $\sigma_x, \sigma_y, \sigma_{xy}, \sigma_z, \sigma_{max}, \sigma_{min}, \beta, \sigma_s, \sigma_e$ (see description of principal stresses)
	Strain: $\epsilon_x, \epsilon_y, \gamma_{xy}, \epsilon_z, \epsilon_{max}, \epsilon_{min}, \beta, \epsilon_s, \epsilon_e$

Modeller See [Results Tables \(Appendix K\)](#).

Local Axes

Not applicable (global axes are the reference).

Sign Convention

- Standard 2D continuum element

Formulation

Geometric Nonlinearity

Total Lagrangian	For large displacements and large rotations.
Updated Lagrangian	For large displacements and large rotations.
Eulerian	For large displacements, large rotations and moderately large strains.
Co-rotational	Not applicable.

Integration Schemes

Stiffness	Default.	6-point (TXK6), 3x3 (QXK8)
	Fine (see <i>Options</i>).	12-point (TXK6).
Mass	Default.	6-point (TXK6), 3x3 (QXK8)
	Fine (see <i>Options</i>).	12-point (TXK6).

Mass Modelling

- Consistent mass (default).
- Lumped mass.

Options

- 18** Invokes finer integration rule.
- 47** X-axis taken as axis of symmetry.
- 54** Updated Lagrangian geometric nonlinearity.
- 55** Output strains as well as stresses.
- 87** Total Lagrangian geometric nonlinearity.
- 91** Invokes fine integration rule for mass matrix.
- 105** Lumped mass matrix
- 123** Clockwise node numbering.

- 139 Output yielded Gauss points only.
- 167 Eulerian geometric nonlinearity.

Notes on Use

1. The element formulations are based on the standard [isoparametric](#) approach. Moving the mid-side nodes to the quarter points creates a singularity with theoretically infinite stress at the corner node.
2. Non-conservative loading is available with these elements when using either Updated Lagrangian or Eulerian geometric nonlinear formulations together with the FLD loading facility.
3. Option 123 will not operate on a mesh with a mixture of clockwise and anti-clockwise elements, it will only work if **every** element is numbered **clockwise**. The best way to avoid a mixture is to check and appropriately reverse the surface definitions in the pre-processing stage of modelling.
4. Using Option 123 with local loading types, such as FLD and UDL, will cause load reversal.
5. The maximum and minimum principal stress computations for axisymmetric elements do not include the σ_z term as this is implicitly a principal stress in a biaxial stress field.

Restrictions

- [Avoid excessive element curvature](#)
- Avoid excessive aspect ratio

Recommendations on Use

The QXK8 and TXK6 elements are specifically designed for application to fracture mechanics problems and may be used to model the singularities that occur at the crack tip. The mid-side nodes near the crack tip are shifted to the quarter point. This ensures a singularity is present at the crack tip and that the strains vary as $1/\sqrt{r}$ where r is the distance from the crack tip. The triangular TPK6 element is more effective than the quadrilateral element.

2D Axisymmetric Solid Explicit Dynamics Elements

General

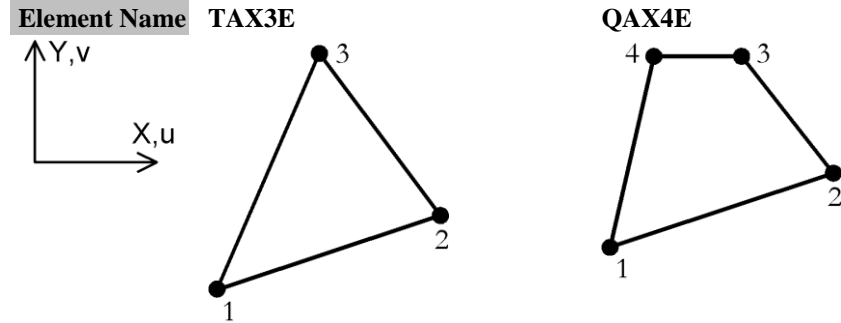

Element Group	2D Continuum
Element Subgroup	Axisymmetric Solid Continuum
Element Description	A family of 2D isoparametric elements for explicit dynamic analyses. The formulations apply over a unit radian segment of structure and loading boundary conditions are axisymmetric. By default, the Y-axis is taken as the axis of symmetry. The elements are numerically integrated.
Number Of Nodes	3 or 4 numbered anticlockwise.
Freedoms	U, V: at each node.
Node Coordinates	X, Y: at each node.

Geometric Properties

Not applicable (a unit radian segment is assumed).

Material Properties

Linear	Isotropic:	MATERIAL PROPERTIES (Elastic: Isotropic)
	Orthotropic:	MATERIAL PROPERTIES ORTHOTROPIC AXISYMMETRIC (Elastic: Orthotropic Axisymmetric)
	Anisotropic:	Not applicable
	Rigidities:	Not applicable
Matrix	Not applicable	
Joint	Not applicable	

	applicable	
Concrete	Not applicable	
Elasto-Plastic	Stress resultant: Tresca:	Not applicable MATERIAL PROPERTIES NONLINEAR 61 (Elastic: Isotropic, Plastic: Tresca, Hardening: Isotropic Hardening Gradient, Isotropic Plastic Strain or Isotropic Total Strain)
	Drucker-Prager:	MATERIAL PROPERTIES NONLINEAR 64 (Elastic: Isotropic, Plastic: Drucker-Prager, Hardening: Granular)
	Mohr-Coulomb:	MATERIAL PROPERTIES NONLINEAR 65 (Elastic: Isotropic, Plastic: Mohr-Coulomb, Hardening: Granular with Dilation)
	Modified Mohr-Coulomb:	MATERIAL PROPERTIES MODIFIED MOHR_COULOMB (Elastic: Isotropic, Plastic: Mohr-Coulomb/Tresca, non-associative Hardening with tension/compression cut-off)
	Optimised Implicit Von Mises:	MATERIAL PROPERTIES NONLINEAR 75 (Elastic: Isotropic, Plastic: Von Mises, Hardening: Isotropic & Kinematic)
	Volumetric Crushing: Stress Potential	MATERIAL PROPERTIES NONLINEAR 81 (Volumetric Crushing or Crushable Foam) STRESS POTENTIAL VON_MISES, HILL, HOFFMAN (Isotropic: von Mises, Modified von Mises Orthotropic: Hill, Hoffman)
Creep	AASHTO	CREEP PROPERTIES (Creep) (See <i>Notes</i>) MATERIAL PROPERTIES NONLINEAR 86 AASHTO (Concrete creep model to AASHTO code of Practice)
	CEB-FIP	MATERIAL PROPERTIES NONLINEAR 86 CEB-FIP (Concrete creep model to CEB-FIP Model Code 1990)
	Chinese	MATERIAL PROPERTIES NONLINEAR 86 CHINESE (Chinese creep model to Chinese Code of Practice)

	Eurocode	MATERIAL PROPERTIES NONLINEAR 86 EUROCODE (Concrete creep model to EUROCODE_2)
	IRC	MATERIAL PROPERTIES NONLINEAR 86 IRC (Concrete creep model to Indian IRC code of Practice)
Damage		DAMAGE PROPERTIES SIMO, OLIVER (Damage)
Viscoelastic		VISCO ELASTIC PROPERTIES
Shrinkage	Not applicable	
Ko Initialisation	Applicable	
Rubber	Not applicable	
Generic Polymer	Not applicable	
Composite	Not applicable	
Loading		
Prescribed Value	PDSP, TPDSP	Prescribed variable. U, V: at each node.
Concentrated Loads	CL	Concentrated loads. Px, Py: at each node.
Element Loads	Not applicable.	
Distributed Loads	UDL	Not applicable.
	FLD	Face loads. Px, Py: local face axis pressures at nodes.
	FLDG	Not applicable.
Body Forces	CBF	Constant body forces for element. Xcbf, Ycbf, Ω_x , Ω_y (angular velocity must be applied about axis of symmetry), 0,0.
	BFP, BFPE	Body force potentials at nodes/for element. 0, 0, 0, ϕ_4 , Xcbf, Ycbf
Velocities	VELO	Velocities. Vx, Vy at nodes.
Accelerations	ACCE	Acceleration. Ax, Ay at nodes.
Viscous Support Loads	VSL	Viscous support loads. VLx, VLy: at nodes.

Initial Stress/Strains	SSI, SSIE	Initial stresses/strains at nodes/for element. σ_x , σ_y , σ_{xy} , σ_z : global stresses. ϵ_x , ϵ_y , γ_{xy} , ϵ_z : global strains.
	SSIG	Initial stress/strains at Gauss points. σ_x , σ_y , σ_{xy} , σ_z : global stress. ϵ_x , ϵ_y , γ_{xy} , ϵ_z : global strains.
Residual Stresses	SSR, SSRE	Residual stresses at nodes/for element σ_x , σ_y , σ_{xy} , σ_z : global stresses.
	SSRG	Residual stresses at Gauss points. σ_x , σ_y , σ_{xy} , σ_z : global stresses.
Target Stress/Strains	Not applicable.	
Temperatures	TEMP, TMPE	Temperatures at nodes/for element. T, 0, 0, 0, To, 0, 0, 0
Overburden	Not applicable	
Phreatic Surface	Not applicable.	
Field Loads	Not applicable.	
Temp Dependent Loads	Not applicable.	

LUSAS Output

Solver	Stress (default): σ_x , σ_y , σ_{xy} , σ_z , σ_{max} , σ_{min} , β , σ_s , σ_e (see description of principal stresses) Strain: ϵ_x , ϵ_y , γ_{xy} , ϵ_z , ϵ_{max} , ϵ_{min} , β , ϵ_s , ϵ_e
Modeller	See Results Tables (Appendix K)

Local Axes

Not applicable.

Sign Convention

- [Standard 2D continuum element](#)

Formulation

Geometric Nonlinearity

Total Lagrangian	Not applicable.
Updated Lagrangian	Not applicable.
Eulerian	For large displacements, large rotations and moderately large strains.
Co-rotational	Not applicable.

Integration Schemes

Stiffness	Default.	1-point (see <i>Notes</i>)
	Fine.	As default.
Mass	Default.	1-point (see <i>Notes</i>)
	Fine.	As default.

Mass Modelling

- Lumped mass (see *Notes*).

Options

47	X-axis taken as axis of symmetry
55	Output strains as well as stresses.
105	Lumped mass matrix (see <i>Notes</i>).
139	Output yielded Gauss points only.

Notes on Use

1. The element formulations are based on the standard
2. The system parameter HGVISC is used to restrict element mechanisms due to under-integration. The default value is usually sufficient.
3. The bulk viscosity coefficients are used to restrict numerical oscillations due to the traversal of stress waves. The default bulk viscosity coefficients (BULKLF and BULKQF) may be altered as a SYSTEM parameter.
4. These elements must be used with a dynamic central difference scheme and a lumped mass matrix.
5. These elements are not applicable to static or eigenvalue analyses.
6. Automatic time step calculations are implemented.

7. As the element geometry is always updated in an explicit dynamic analysis, a nonlinear solution is obtained. When using explicit dynamics elements Nonlinear Control must be specified.
8. If CREEP PROPERTIES are defined explicit time integration must be specified in VISCOUS CONTROL.
9. Non-conservative loading is invoked when the face loading (FLD) is applied.
10. Rayleigh damping coefficients are not supported by these elements.
11. Constraint equations are not available for use with these elements.
12. Nodes **must** be specified in an anticlockwise order. Option 123 is **not** applicable for this element. When using Modeller ensure surface normal is in the +ve z direction.
13. The maximum and minimum principal stress computations for axisymmetric elements do not include the σ_z term as this is implicitly a principal stress in a biaxial stress field.

Restrictions

- ❑ [Avoid excessive aspect ratio](#)

Recommendations on Use

Explicit dynamics elements may be used to define surface boundaries which will be active in a slideline analysis.

2D Axisymmetric Solid Two Phase Continuum Elements

General

Element Name TAX6P

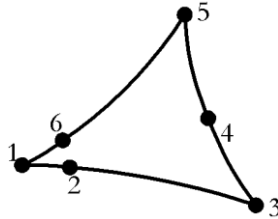
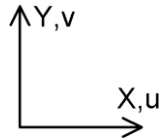

Element Name QAX8P

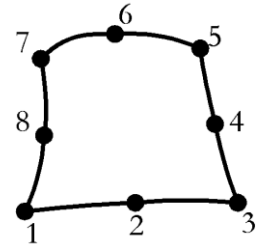

Element Group 2D Continuum
Element Subgroup Axisymmetric Solid

Element Description A family of 2D **isoparametric** elements with higher order models capable of modelling curved boundaries. The formulations apply over a unit radian segment of the structure and the loading and boundary conditions are axisymmetric. By default, the Y-axis is taken as the axis of symmetry. The elements are numerically integrated.

Number Of Nodes 6 or 8 numbered anticlockwise.

Freedom Node U, V, P: at corner nodes. U, V: at midside nodes.

Coordinates X, Y: at each node.

Geometric Properties

Not applicable (a unit radian segment is assumed).

Material Properties

Linear Isotropic:	MATERIAL PROPERTIES (Elastic: Isotropic)
Orthotropic:	MATERIAL PROPERTIES ORTHOTROPIC AXISYMMETRIC (Elastic: orthotropic, Axisymmetric)
Anisotropic:	MATERIAL PROPERTIES ANISOTROPIC 4 (Not supported in LUSAS Modeller)
Rigidities:	Not applicable.

Matrix	Not applicable	
Joint	Not applicable	
Concrete		MATERIAL PROPERTIES NONLINEAR 109 (Elastic: Isotropic, Plastic: Smoothed Multi-Crack Concrete)
Elasto-Plastic	Stress resultant:	Not applicable.
	Interface:	MATERIAL PROPERTIES NONLINEAR 27.
	Tresca:	MATERIAL PROPERTIES NONLINEAR 61 (Elastic: Isotropic, Plastic: Tresca, Hardening: Isotropic Hardening Gradient, Isotropic Plastic Strain or Isotropic Total Strain)
	Drucker-Prager:	MATERIAL PROPERTIES NONLINEAR 64 (Elastic: Isotropic, Plastic: Drucker-Prager, Hardening: Granular)
	Mohr-Coulomb:	MATERIAL PROPERTIES NONLINEAR 65 (Elastic: Isotropic, Plastic: Mohr-Coulomb, Hardening: Granular with Dilation)
	Modified Mohr-Coulomb:	MATERIAL PROPERTIES MODIFIED MOHR_COULOMB (Elastic: Isotropic, Plastic: Mohr-Coulomb/Tresca, non-associative Hardening with tension/compression cut-off)
	Modified Cam-clay	MATERIAL PROPERTIES CAM_CLAY MODIFIED (Elastic: Isotropic, Plastic)
	Optimised Implicit Von Mises:	MATERIAL PROPERTIES NONLINEAR 75 (Elastic: Isotropic, Plastic: Von Mises, Hardening: Isotropic & Kinematic)
	Volumetric Crushing:	MATERIAL PROPERTIES NONLINEAR 81 (Volumetric Crushing or Crushable Foam)
	Stress Potential	STRESS POTENTIAL VON_MISES, HILL, HOFFMAN (Isotropic: von Mises, Modified von Mises Orthotropic: Hill, Hoffman)
Creep		CREEP PROPERTIES (Creep)
Damage		DAMAGE PROPERTIES SIMO, OLIVER (Damage)
Viscoelastic		VISCO ELASTIC PROPERTIES
Shrinkage		SHRINKAGE CEB_FIP_90, EUROCODE_2, GENERAL, USER
Ko Initialisation	Applicable	
Rubber	Not applicable	
Generic	Isotropic	MATERIAL PROPERTIES NONLINEAR 89

Polymer Composite Not applicable (Generic Polymer Model)

Loading

Prescribed Value	PDSP, TPDSP	Prescribed variable. U, V, P: at corner nodes. U, V: at midsaide nodes.
Concentrated Loads	CL	Concentrated loads. Px, Py, Q: force/flux per unit radian at corner nodes. Px,Py: force per unit radian at midside nodes.
Element Loads	Not applicable.	
Distributed Loads	UDL FLD	Not available. Face loads. Px, Py, Q: local face pressures/flux at corner nodes (force/flux per unit area). Px, Py: local face pressures at midside nodes.
Body Forces	FLDG CBF BFP, BFPE	Global Face Loads. $\sigma_x, \sigma_y, \sigma_{xy}$ at nodes Constant body forces for element. Xcbf, Ycbf, Ω_x, Ω_y (angular velocity must be applied about axis of symmetry), 0, 0, gx, gy. (See Notes on Use) Body force potentials at nodes/for element. 0, 0, 0, ϕ_4 , Xcbf, Ycbf, gx, gy. (See Notes on Use)
Velocities	VELO	Velocities. Vx, Vy: at nodes.
Accelerations	ACCE	Acceleration Ax, Ay: at nodes.
Viscous Support Loads	VSL	Viscous support loads. VLx, VLy: at nodes.
Initial Stress/Strains	SSI, SSIE SSIG	Initial stresses/strains at nodes/for element. $\sigma_x, \sigma_y, \sigma_{xy}, \sigma_z, \sigma_p$: global stresses. $\epsilon_x, \epsilon_y, \gamma_{xy}, \epsilon_z$: global strains. Initial stresses/strains at Gauss points. $\sigma_x, \sigma_y, \sigma_{xy}, \sigma_z, \sigma_p$: global stresses. $\epsilon_x, \epsilon_y, \gamma_{xy}, \epsilon_z$: global strains.
Residual Stresses	SSR, SSRE SSRG	Residual stresses at nodes/for element. $\sigma_x, \sigma_y, \sigma_{xy}, \sigma_z, \sigma_p$: global stresses. Residual stresses at Gauss points. $\sigma_x, \sigma_y, \sigma_{xy}, \sigma_z, \sigma_p$: global stresses.
Target Stress/Strains	TSSIE, TSSIA	Target stresses/strains at nodes/for element. $\sigma_x, \sigma_y, \sigma_{xy}, \sigma_z, \sigma_p$: global stresses. $\epsilon_x, \epsilon_y, \gamma_{xy}, \epsilon_z$: global strains.

	TSSIG	Target stresses/strains at Gauss points. σ_x , σ_y , σ_{xy} , σ_z , σ_p : global stresses. ϵ_x , ϵ_y , γ_{xy} , ϵ_z : global strains.
Temperatures	TEMP, TMPE	Temperatures at nodes/for element. T, 0, 0, 0, T ₀ , 0, 0, 0
Overburden		Applicable.
Phreatic Surface		Applicable.
Field Loads		Not applicable.
Temp Dependent Loads		Not applicable.

LUSAS Output

Solver	Stress (default): σ_x , σ_y , σ_{xy} , σ_z , σ_p , σ_{max} , σ_{min} , β , σ_s , σ_e (see description of principal stresses) Strain: ϵ_x , ϵ_y , γ_{xy} , ϵ_z , ϵ_{max} , ϵ_{min} , β , ϵ_s , ϵ_e
Modeller	See Results Tables (Appendix K) .

Local Axes

Not applicable (global axes are the reference).

Sign Convention

- ❑ [Standard 2D continuum element](#)

Formulation

Geometric Nonlinearity

Total Lagrangian	For large displacements and large rotations.
Updated Lagrangian	For large displacements and large rotations.
Eulerian	For large displacements, large rotations and moderately large strains.
Co-rotational	Not applicable.

Integration Schemes

Stiffness	Default.	3-point (TAX6P), 2x2 (QAX8P)
	Fine (see <i>Options</i>).	3x3 (QAX8P)

Mass	Default.	3-point (TAX6P), 2x2 (QAX8P)
	Fine (see <i>Options</i>).	3x3 (QAX8P)

Mass Modelling

- Consistent mass (default).
- Lumped mass.

Options

- 18** Invokes finer integration rule.
- 47** X-axis taken as axis of symmetry
- 54** Updated Lagrangian geometric nonlinearity.
- 55** Output strains as well as stresses.
- 87** Total Lagrangian geometric nonlinearity.
- 91** Invokes fine integration rule for mass matrix.
- 105** Lumped mass matrix.
- 123** Clockwise node numbering.
- 139** Output yielded Gauss points only.
- 167** Eulerian geometric nonlinearity.

Notes on Use

1. Two phase material parameters must be used with these elements for undrained and consolidation analysis.
2. The element formulations are based on the standard [isoparametric](#) approach. The variation of isoparametric stresses and pore pressures within an element can be regarded as linear.
3. All elements pass the [patch test](#).
4. Non-conservative loading is available with these elements when using either Updated Lagrangian or Eulerian geometric nonlinear formulations together with the FLD loading facility.
5. Option 123 will not operate on a mesh with a mixture of clockwise and anti-clockwise elements, it is only applicable if **every** element is numbered **clockwise**. Surface normals should be visualised and if necessary corrected in the pre-processing stage.
6. Using Option 123 with local loading types, such as FLD and UDL, will cause load reversal.
7. The global components of gravity acting on the fluid phase are defined by gx and gy under CBF and BFP loading.

8. The maximum and minimum principal stress computations for axisymmetric elements do not include the σ_z term as this is implicitly a principal stress in a biaxial stress field.

Restrictions

- Ensure mid-side node centrality
- Avoid excessive element curvature
- Avoid excessive aspect ratio

Recommendations on Use

- The 8-noded element with a 2*2 Gauss rule is usually the most effective element, as the under-integration of the stiffness matrix prevents locking, which may occur either when the element is subjected to [parasitic shear](#), or as the material reaches the incompressible limit (elasto-plasticity). The Gauss point stresses are also sampled at the most accurate locations for the element. However, the element does possess one spurious zero energy mode. This mode is very rarely activated in linear analysis, but it may occur in both materially and geometrically nonlinear analyses. Therefore, a careful examination of the solution should be performed, to check for spurious stress oscillations and peculiarities in the deformed configuration.
- The 8-noded element with a 3*3 Gauss rule may be used if a spurious mechanism is excited with the 2*2 Gauss rule.

2D Axisymmetric Fourier Ring Elements

General

Element Name

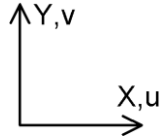

TAX3F

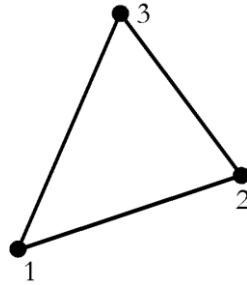

TAX6F

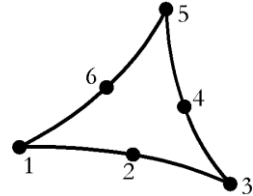

QAX4F

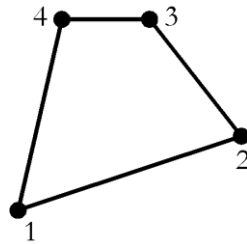

QAX8F

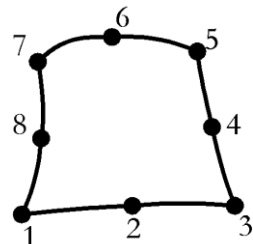

Element Group 2D Continuum

Element Subgroup Fourier Ring

Element Description A family of 2D [isoparametric](#) elements with higher order models capable of modelling curved boundaries. The structure must be axisymmetric but the loading need not be. By default the Y-axis is taken to be the axis of symmetry. The elements are numerically integrated.

Number Of Nodes 3, 4, 6 or 8 numbered anticlockwise.

Freedom U, V, W: at each node (in cylindrical coordinates, see [local coordinates](#)).

Node Coordinates X, Y: at each node.

Geometric Properties

Not applicable.

Material Properties

Linear	Isotropic:	MATERIAL PROPERTIES (Elastic: Isotropic)
	Orthotropic:	MATERIAL PROPERTIES ORTHOTROPIC (Elastic: Orthotropic Plane Stress)
		MATERIAL PROPERTIES ORTHOTROPIC SOLID (Elastic: Orthotropic Solid)
	Anisotropic: Rigidities.	Not applicable Not applicable
Matrix	Not applicable	
Joint	Not applicable	
Concrete	Not applicable	
Elasto-Plastic	Not applicable	
Creep	Not applicable	
Damage	Not applicable	
Viscoelastic	Not applicable	
Shrinkage	Not applicable	
Ko Initialisation	Not applicable	
Rubber	Not applicable	
Generic Polymer	Not applicable	
Composite	Not applicable	

Loading

Prescribed Value	PDSP, TPDSP	Prescribed variable. U, V, W: at each node.
Concentrated Loads	CL	Concentrated loads. Px, Py, Pz: at each node (global, may also be applied locally, see options).
Element Loads	Not applicable.	
Distributed Loads	UDL FLD FLDG	Not applicable. Face loads. Px, Py, Pz: local face axis pressures at nodes Pz in the direction of increasing θ . Not applicable.
Body Forces	CBF	Constant body forces for element (see <i>Notes</i>).

		Xcbf, Ycbf, Zcbf, Ω_x , Ω_y , Ω_z , α_x , α_y , α_z , Xo, Yo, Zo, d θ /dt
	BFP, BFPE	Body force potentials at nodes/for element. Xcbf, Ycbf, Zcbf
Velocities	VELO	Velocities. Vx, Vy, Vz at nodes.
Accelerations	ACCE	Acceleration. Ax, Ay, Az at nodes.
Viscous Support Loads	VSL	Not applicable.
Initial Stress/Strains	SSI, SSIE	Initial stresses/strains at nodes/for element. σ_x , σ_y , σ_z , σ_{xy} , σ_{yz} , σ_{xz} : local stresses. ϵ_x , ϵ_y , ϵ_z , γ_{xy} , γ_{yz} , γ_{xz} : local strains.
	SSIG	Initial stresses/strains at Gauss points. σ_x , σ_y , σ_z , σ_{xy} , σ_{yz} , σ_{xz} : local stresses. ϵ_x , ϵ_y , ϵ_z , γ_{xy} , γ_{yz} , γ_{xz} : local strains.
Residual Stresses	Not applicable.	
Target Stress/Strains	Not applicable.	
Temperatures	TEMP, TMPE	Temperatures at nodes/for element. T, 0, 0, 0, To, 0, 0, 0
Overburden	Not applicable.	
Phreatic Surface	Not applicable.	
Field Loads	Not applicable.	
Temp Dependent Loads	Not applicable.	

LUSAS Output

Solver	Stress (default): σ_x , σ_y , σ_z , σ_{xy} , σ_{yz} , σ_{xz} , σ_{max} , σ_{min} , β , σ_s , σ_e (see description of principal stresses) Strain: ϵ_x , ϵ_y , ϵ_z , γ_{xy} , γ_{yz} , γ_{xz} , ϵ_{max} , ϵ_{min} , β , ϵ_s , ϵ_e Use LUSAS Modeller to access results at various angles around the structure. See Local and Global Results in the <i>Modeller User Manual</i>
Modeller	See Results Tables (Appendix K) .

Local Axes

- Cylindrical coordinates (see *Appendix F*).
- The element axes are defined in the cylindrical coordinate system x,y,z , with associated displacements u,v,w . The tangential displacement w is positive in the direction of increasing θ , where θ is the positive rotation defined by the right-hand coordinate system about the axis of symmetry. u and v are positive in the direction of increasing x and y respectively and may be either axial or radial displacements depending on the definition of the axis of symmetry.

Sign Convention

- Standard 3D continuum element

Formulation

Geometric Nonlinearity

Not applicable.

Integration Schemes

Stiffness	Default.	1-point (TAX3F), 3-point (TAX6F), 2x2 (QAX4F, QAX8F)
	Fine (see <i>Options</i>).	3x3 (QAX8F), 3-point (TAX3F)
Mass	Default.	1-point (TAX3F), 3-point (TAX6F), 2x2 (QAX4F, QAX8F)
	Fine (see <i>Options</i>).	3x3 (QAX8F), 3-point (TAX3F)

Mass Modelling

- Consistent mass (default).
- Lumped mass.

Options

- 18** Invokes fine integration rule.
- 47** X-axis taken as axis of symmetry.
- 55** Output strains as well as stresses.
- 102** Switch off load correction stiffness matrix due to centripetal acceleration.
- 105** Lumped mass matrix.
- 202** Apply concentrated loads in cylindrical coordinates.

Notes on Use

1. CBF loads are always applied as acceleration loading. X_o , Y_o , Z_o , permit a shift in the original point of the global coordinate system (about which the rotations are applied). $d\theta/dt$ is the local angular velocity about the finite element coordinate system.
2. The application of the CBF loading depends on the particular element material model selected. See the description of Fourier analysis in *Chapter 2* of the *LUSAS User Guide*.
3. If CBF loads are used the structure must be axisymmetric about the X-axis (option 47).
4. Fourier elements cannot be mixed with other element types.
5. Temperature fields cannot be used in dynamic or harmonic response analyses.
6. Centripetal load stiffening has been applied to the $n=0$ term, but there is no nonlinear stress stiffening contribution. The centripetal load stiffening matrix, contrary, to its name, actually decreases the stiffness of the structure. Centripetal forces are proportional to the angular rotation squared and the lever arm of the mass from the centre of rotation. As the body spins, the lever arm is lengthened by positive displacements, which increases the applied load. This may, conversely, be thought of as reducing the stiffness. The centripetal load stiffness is applied by default, but is may be omitted by setting option 102.
7. The maximum and minimum principal stress computations for axisymmetric elements do not include the σ_z term as this is implicitly a principal stress in a biaxial stress field.

Restrictions

- [Ensure mid-side node centrality](#)
- [Avoid excessive element curvature](#)
- Avoid excessive aspect ratio

Recommendations on Use

- The element is designed to model fairly solid structures, but it also performs well in comparison to standard shell analyses and may be an effective alternative for axisymmetric problems. The QAX8F is the most effective element of the family.
- If eigenvalues are required from a thin shelled structure such as a cylinder, the Fourier elements provide an efficient means of checking a range of circumferential harmonics and will indicate the permissible coarseness of a finite element mesh which will adequately represent the 3D variation.

Chapter 4 : 3D Continuum Elements

3D Solid Continuum Elements

General

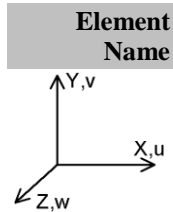

TH4

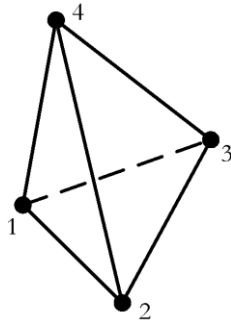

TH10

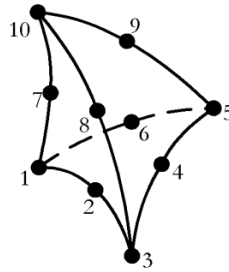

PN6

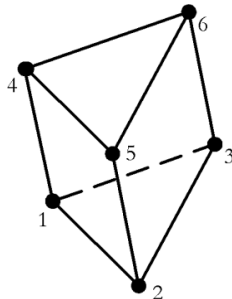

PN12

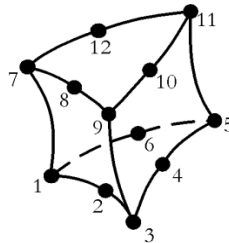

PN15

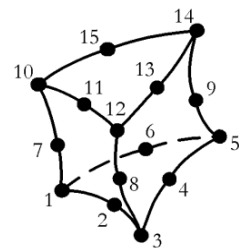

HX8

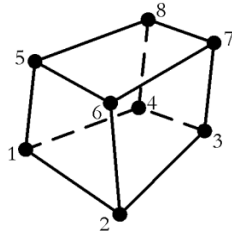

HX16

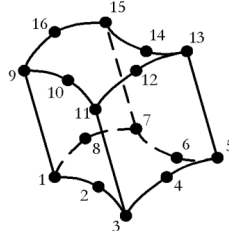

HX20

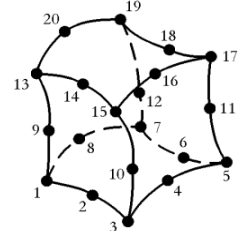

Element Group
Element
Subgroup
Element
Description

3D Continuum
 Solid Continuum

A family of 3D isoparametric solid continuum elements with higher order models capable of modelling curved boundaries. The elements are numerically integrated.

Number Of Nodes	4 or 10 (tetrahedra). 6, 12 or 15 (pentahedra). 8, 16 or 20 (hexahedra). The elements are numbered according to a right-hand screw rule in the local z-direction.
Freedom Node	U, V, W: at each node.
Coordinates	X, Y, Z: at each node.

Geometric Properties

Not applicable.

Material Properties

Linear	Isotropic:	MATERIAL PROPERTIES (Elastic: Isotropic)
	Orthotropic:	MATERIAL PROPERTIES ORTHOTROPIC SOLID (Elastic: Orthotropic Solid)
	Anisotropic:	MATERIAL PROPERTIES ANISOTROPIC SOLID (Elastic: Anisotropic Solid)
	Rigidities.	Not applicable.
Matrix	Not applicable.	
Joint	Not applicable.	
Concrete		MATERIAL PROPERTIES NONLINEAR 105 (Elastic: Isotropic, Plastic: Transient Smoothed Multi-Crack Concrete)
		MATERIAL PROPERTIES NONLINEAR 109 (Elastic: Isotropic, Plastic: Smoothed Multi-Crack Concrete)
Elasto-Plastic	Stress resultant:	Not applicable.
	Tresca:	MATERIAL PROPERTIES NONLINEAR 61 (Elastic: Isotropic, Plastic: Tresca, Hardening: Isotropic Hardening Gradient, Isotropic Plastic Strain or Isotropic Total Strain)
	Drucker-Prager:	MATERIAL PROPERTIES NONLINEAR 64 (Elastic: Isotropic, Plastic: Drucker-Prager, Hardening: Granular)
	Mohr-Coulomb:	MATERIAL PROPERTIES NONLINEAR 65 (Elastic: Isotropic, Plastic: Mohr-Coulomb, Hardening: Granular with Dilation)
	Modified Mohr-Coulomb:	MATERIAL PROPERTIES MODIFIED MOHR_COULOMB (Elastic: Isotropic, Plastic: Mohr-Coulomb/Tresca, non-

		associative Hardening with tension/compression cut-off)
	Modified Cam-clay	MATERIAL PROPERTIES CAM_CLAY MODIFIED (Elastic: Isotropic, Plastic)
	Optimised Implicit Von Mises:	MATERIAL PROPERTIES NONLINEAR 75 (Elastic: Isotropic, Plastic: Von Mises, Hardening: Isotropic & Kinematic)
	Volumetric Crushing:	MATERIAL PROPERTIES NONLINEAR 81 (Volumetric Crushing or Crushable Foam)
	Stress Potential:	STRESS POTENTIAL VON_MISES, HILL, HOFFMAN (Isotropic: von Mises, Modified von Mises Orthotropic: Hill, Hoffman)
Creep		CREEP PROPERTIES (Creep)
	AASHTO	MATERIAL PROPERTIES NONLINEAR 86 AASHTO (Concrete creep model to AASHTO code of Practice)
	CEB-FIP	MATERIAL PROPERTIES NONLINEAR 86 CEB-FIP (Concrete creep model to CEB-FIP Model Code 1990)
	Chinese	MATERIAL PROPERTIES NONLINEAR 86 CHINESE (Chinese creep model to Chinese Code of Practice)
	Eurocode	MATERIAL PROPERTIES NONLINEAR 86 EUROCODE (Concrete creep model to EUROCODE_2)
	IRC	MATERIAL PROPERTIES NONLINEAR 86 IRC (Concrete creep model to Indian IRC code of Practice)
Damage		DAMAGE PROPERTIES SIMO, OLIVER (Damage)
Viscoelastic		VISCO ELASTIC PROPERTIES
Shrinkage		SHRINKAGE CEB_FIP_90, EUROCODE_2, GENERAL, USER

Ko Initialisation Applicable

Elasto- Plastic Interface Rubber	Not applicable.	MATERIAL PROPERTIES NONLINEAR 26
Generic Polymer	Isotropic	MATERIAL PROPERTIES NONLINEAR 89 (Generic Polymer Model)
Composite	Not applicable	

Loading

Prescribed Value Concentrated Loads	PDSP, TPDSP CL	Prescribed variable. U, V, W: at each node. Concentrated loads. Px, Py, Pz: at each node.
Element Loads	Not applicable.	
Distributed Loads	UDL FLD FLDG	Not applicable. Face Loads. Px, Py, Pz: local face pressures at nodes. Global Face Loads. $\sigma_x, \sigma_y, \sigma_z, \sigma_{xy}, \sigma_{yz}, \sigma_{xz}$ at nodes
Body Forces	CBF BFP, BFPE	Constant body forces for element. Xcbf, Ycbf, Zcbf, $\Omega_x, \Omega_y, \Omega_z, \alpha_x, \alpha_y, \alpha_z$ Body force potentials at nodes/for element. 0, 0, 0, $\phi_4, Xcbf, Ycbf, Zcbf$
Velocities	VELO	Velocities. Vx, Vy, Vz: at nodes.
Accelerations	ACCE	Acceleration Ax, Ay, Az: at nodes.
Viscous Support Loads	VSL	Viscous support loads. VLx, VLy, VLz: at nodes.
Initial Stress/Strains	SSI, SSIE SSIG	Initial stresses/strains at nodes/for element. $\sigma_x, \sigma_y, \sigma_z, \sigma_{xy}, \sigma_{yz}, \sigma_{xz}$: global stresses. $\epsilon_x, \epsilon_y, \epsilon_z, \gamma_{xy}, \gamma_{yz}, \gamma_{xz}$: global strains. Initial stresses/strains at Gauss points $\sigma_x, \sigma_y, \sigma_z, \sigma_{xy}, \sigma_{yz}, \sigma_{xz}$: global stresses. $\epsilon_x, \epsilon_y, \epsilon_z, \gamma_{xy}, \gamma_{yz}, \gamma_{xz}$: global strains.
Residual Stresses	SSR, SSRE SSRG	Residual stresses at nodes/for element. $\sigma_x, \sigma_y, \sigma_z, \sigma_{xy}, \sigma_{yz}, \sigma_{xz}$: global stresses. Residual stresses at Gauss points. $\sigma_x, \sigma_y, \sigma_z,$

		$\sigma_{xy}, \sigma_{yz}, \sigma_{xz}$ global stresses.
Target Stress/Strains	TSSIE, TSSIA	Target stresses/strains at nodes/for element. $\sigma_x, \sigma_y, \sigma_z, \sigma_{xy}, \sigma_{yz}, \sigma_{xz}$: global stresses. $\epsilon_x, \epsilon_y, \epsilon_z, \gamma_{xy}, \gamma_{yz}, \gamma_{xz}$: global strains.
	TSSIG	Target stresses/strains at Gauss points $\sigma_x, \sigma_y, \sigma_z, \sigma_{xy}, \sigma_{yz}, \sigma_{xz}$: global stresses. $\epsilon_x, \epsilon_y, \epsilon_z, \gamma_{xy}, \gamma_{yz}, \gamma_{xz}$: global strains.
Temperatures	TEMP, TMPE	Temperatures at nodes/for element. T, 0, 0, 0, To, 0, 0, 0
Overburden	Applicable.	
Phreatic Surface	Applicable.	
Field Loads	Not applicable.	
Temp Dependent Loads	Not applicable.	

LUSAS Output

Solver	Stress (default): $\sigma_x, \sigma_y, \sigma_z, \sigma_{xy}, \sigma_{yz}, \sigma_{xz}, \sigma_e$: global stresses. Strain: $\epsilon_x, \epsilon_y, \epsilon_z, \gamma_{xy}, \gamma_{yz}, \gamma_{xz}, \epsilon_e$: global strains. For optional principal stress/strain output, together with the corresponding direction cosines, use Option 77.
Modeller	See Results Tables (Appendix K) .

Local Axes

Not applicable (global axes are the reference).

Sign Convention

- [Standard 3D continuum element](#)

Formulation

Geometric Nonlinearity

Total Lagrangian	For large displacements and large rotations.
Updated Lagrangian	For large displacements and large rotations.
Eulerian	For large displacements, large rotations and moderately large

strains.

Co-rotational For large displacements and large rotations.

Integration Schemes

Stiffness	Default.	1-point (TH4), 4-point (TH10), 3x2 (PN6, PN12, PN15), 2x2x2 (HX8, HX16, HX20)
	Fine (see <i>Options</i>).	5-point (TH10), 3x3x2 (HX16), 3x3x3 (HX20)
	Coarse (see <i>Options</i>)	13-point (HX20), 14-point (HX20)
Mass	Default.	1-point (TH4), 4-point (TH10), 3x2 (PN6, PN12, PN15), 2x2x2 (HX8, HX16, HX20)
	Fine (see <i>Options</i>).	4-point (TH4) 11-point (TH10), 14-point (TH10) 3x3x2 (HX16), 3x3x3 (HX20)
	Coarse (see <i>Options</i>)	13-point (HX20), 14-point (HX20)

Mass Modelling

- Consistent mass (default).
- Lumped mass.

Options

- 18** Invokes fine integration rule.
- 36** Follower loads
- 54** Updated Lagrangian geometric nonlinearity
- 55** Output strains as well as stresses.
- 77** Output principal stresses and direction cosines.
- 87** Total Lagrangian geometric nonlinearity.
- 91** Invoke finer integration of the mass matrix.
- 102** Switch off load correction stiffness due to centripetal acceleration.
- 105** Lumped mass matrix.
- 139** Output yielded Gauss points only.
- 155** Use 14-point integration rule for HX20.
- 156** Use 13-point integration rule for HX20.
- 167** Eulerian geometric nonlinearity.
- 229** Co-rotational geometric nonlinearity.
- 395** Use 14-point integration rule for mass matrix of TH10 (used together with Option 91).
- 398** For HX20 and HX16 with fine integration use all integration points for stress

extrapolation.

Notes on Use

1. The elements are based on the standard isoparametric approach. The variation of stresses within an element may be regarded as constant for the lower order elements (corner nodes only), and linear for the higher order elements (with mid-side nodes).
2. All elements pass the [patch test](#).
3. When using table input format for temperature dependent ORTHOTROPIC SOLID or ANISOTROPIC SOLID material properties, the value of nset used is that defined in the first line of the property table.
4. Non-conservative loading is available with these elements when using either Updated Lagrangian or Eulerian geometric nonlinear formulations together with the FLD loading facility.

Restrictions

- [Ensure mid-side node centrality](#)
- [Avoid excessive element curvature](#)
- Avoid excessive aspect ratio

Recommendations on Use

- The 3D solid elements should be used if the stress field is fully 3D, i.e. it cannot be approximated with any of the 2D elements, e.g. as for a non-axisymmetric pressure vessel.
- For linear materials, the 20-noded element with a 2*2*2 Gauss rule is usually the most effective element, as this under-integration of the stiffness matrix prevents locking, i.e. over-stiff solutions will occur if the elements are used with a 3*3*3 Gauss integration rule to model structures subjected to bending. However, the element possesses six [zero energy modes](#). Therefore, a careful examination of the solution should be performed to check for spurious stress oscillations and peculiarities in the deformed configuration. Either the 14-point or 3*3*3 Gauss rules should be used for materially nonlinear problems or materially linear problems that exhibit spurious deformations.
- The 8-noded element should not be used for analyses where bending effects are significant as the element tends to lock in [parasitic shear](#) [C1]. The 8-noded element will perform poorly if it is highly distorted. The 4-noded tetrahedron TH4 element is generally not effective and should only be used if the geometry requires elements of this shape.

3D Solid Continuum Element with Enhanced Strains

General

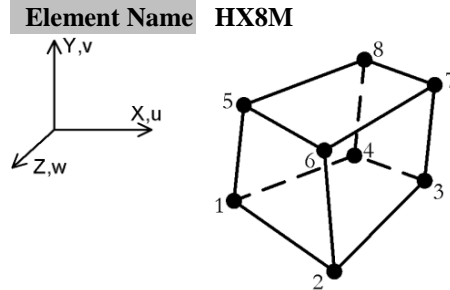

Element Group	3D Continuum
Element Subgroup	Solid Continuum
Element Description	A 3D isoparametric solid element with an incompatible strain field. This mixed assumed strain element demonstrates a much superior performance to that of the HX8 element.
Number Of Nodes	8. The element is numbered according to a right-hand screw rule in the local z-direction.
Freedom Node	U, V, W: at each node.
Coordinates	X, Y, Z: at each node.

Geometric Properties

Not applicable.

Material Properties

Linear	Isotropic:	MATERIAL PROPERTIES (Elastic: Isotropic)
	Orthotropic:	MATERIAL PROPERTIES ORTHOTROPIC SOLID (Elastic: Orthotropic Solid)
	Anisotropic:	MATERIAL PROPERTIES ANISOTROPIC SOLID (Elastic: Anisotropic Solid)
	Rigidities.	Not applicable.
Matrix	Not applicable.	
Joint	Not applicable.	
Concrete		MATERIAL PROPERTIES NONLINEAR 105 (Elastic: Isotropic, Plastic: Transient Smoothed)

		Multi-Crack Concrete)
		MATERIAL PROPERTIES NONLINEAR 109 (Elastic: Isotropic, Plastic: Smoothed Multi-Crack Concrete)
Elasto-Plastic	Stress resultant:	Not applicable.
	Tresca:	MATERIAL PROPERTIES NONLINEAR 61 (Elastic: Isotropic, Plastic: Tresca, Hardening: Isotropic Hardening Gradient, Isotropic Plastic Strain or Isotropic Total Strain)
	Drucker-Prager:	MATERIAL PROPERTIES NONLINEAR 64 (Elastic: Isotropic, Plastic: Drucker-Prager, Hardening: Granular)
	Mohr-Coulomb:	MATERIAL PROPERTIES NONLINEAR 65 (Elastic: Isotropic, Plastic: Mohr-Coulomb, Hardening: Granular with Dilatation)
	Modified Mohr-Coulomb:	MATERIAL PROPERTIES MODIFIED MOHR_COULOMB (Elastic: Isotropic, Plastic: Mohr-Coulomb/Tresca, non-associative Hardening with tension/compression cut-off)
	Modified Cam-clay	MATERIAL PROPERTIES CAM_CLAY MODIFIED (Elastic: Isotropic, Plastic)
	Optimised Implicit Von Mises:	MATERIAL PROPERTIES NONLINEAR 75 (Elastic: Isotropic, Plastic: Von Mises, Hardening: Isotropic & Kinematic)
	Volumetric Crushing:	MATERIAL PROPERTIES NONLINEAR 81 (Volumetric Crushing or Crushable Foam)
	Stress Potential	STRESS POTENTIAL VON_MISES, HILL, HOFFMAN (Isotropic: von Mises, Modified von Mises Orthotropic: Hill, Hoffman)
Creep	AASHTO	MATERIAL PROPERTIES NONLINEAR 86 AASHTO (Concrete creep model to AASHTO code of Practice)
	CEB-FIP	MATERIAL PROPERTIES NONLINEAR 86 CEB-FIP (Concrete creep model to CEB-FIP Model Code 1990)
	Chinese	MATERIAL PROPERTIES NONLINEAR 86 CHINESE (Chinese creep model to Chinese Code of

		Practice)
	Eurocode	MATERIAL PROPERTIES NONLINEAR 86 EUROCODE (Concrete creep model to EUROCODE_2)
	IRC	MATERIAL PROPERTIES NONLINEAR 86 IRC (Concrete creep model to Indian IRC code of Practice)
Damage		DAMAGE PROPERTIES SIMO, OLIVER (Damage)
Viscoelastic Shrinkage		VISCO ELASTIC PROPERTIES SHRINKAGE CEB_FIP_90, EUROCODE_2, GENERAL, USER
Ko Initialisation	Applicable	
Rubber	Ogden:	MATERIAL PROPERTIES RUBBER OGDEN (Rubber: Ogden)
	Mooney- Rivlin:	MATERIAL PROPERTIES RUBBER MOONEY_RIVLIN (Rubber: Mooney-Rivlin)
	Neo- Hookean:	MATERIAL PROPERTIES RUBBER NEO_HOOKEAN (Rubber: Neo-Hookean)
	Hencky:	MATERIAL PROPERTIES RUBBER HENCKY (Rubber: Hencky)
Generic Polymer	Isotropic	MATERIAL PROPERTIES NONLINEAR 89 (Generic Polymer Model)
Composite	Not applicable.	

Loading

Prescribed Value	PDSP, TPDSP	Prescribed variable. U, V, W: at each node.
Concentrated Loads	CL	Concentrated loads. Px, Py, Pz: at each node.
Element Loads	Not applicable.	
Distributed Loads	UDL	Not applicable.
	FLD	Face Loads. Px, Py, Pz: local face pressures at nodes.
	FLDG	Global Face Loads. $\sigma_x, \sigma_y, \sigma_z, \sigma_{xy}, \sigma_{yz}, \sigma_{xz}$ at nodes
Body Forces	CBF	Constant body forces for element. Xcbf, Ycbf, Zcbf, $\Omega_x, \Omega_y, \Omega_z, \alpha_x, \alpha_y, \alpha_z$
	BFP, BFPE	Body force potentials at nodes/for element. 0,

		0, 0, φ_4 , Xcbf, Ycbf, Zcbf
Velocities	VELO	Velocities. Vx, Vy, Vz: at nodes.
Accelerations	ACCE	Acceleration Ax, Ay, Az: at nodes.
Viscous Support Loads	VSL	Viscous support loads. VLx, VLy, VLz: at nodes.
Initial Stress/Strains	SSI, SSIE	Initial stresses/strains at nodes/for element. σ_x , σ_y , σ_z , σ_{xy} , σ_{yz} , σ_{xz} : global stresses. ϵ_x , ϵ_y , ϵ_z , γ_{xy} , γ_{yz} , γ_{xz} : global strains.
	SSIG	Initial stresses/strains at Gauss points σ_x , σ_y , σ_z , σ_{xy} , σ_{yz} , σ_{xz} : global stresses. ϵ_x , ϵ_y , ϵ_z , γ_{xy} , γ_{yz} , γ_{xz} : global strains.
Residual Stresses	SSR, SSRE	Residual stresses at nodes/for element. σ_x , σ_y , σ_z , σ_{xy} , σ_{yz} , σ_{xz} : global stresses.
	SSRG	Residual stresses at Gauss points. σ_x , σ_y , σ_z , σ_{xy} , σ_{yz} , σ_{xz} global stresses.
Target Stress/Strains	TSSIE, TSSIA	Target stresses/strains at nodes/for element. σ_x , σ_y , σ_z , σ_{xy} , σ_{yz} , σ_{xz} : global stresses. ϵ_x , ϵ_y , ϵ_z , γ_{xy} , γ_{yz} , γ_{xz} : global strains.
	TSSIG	Target stresses/strains at Gauss points σ_x , σ_y , σ_z , σ_{xy} , σ_{yz} , σ_{xz} : global stresses. ϵ_x , ϵ_y , ϵ_z , γ_{xy} , γ_{yz} , γ_{xz} : global strains.
Temperatures	TEMP, TMPE	Temperatures at nodes/for element. T, 0, 0, 0, To, 0, 0, 0
Overburden	Applicable.	
Phreatic Surface	Applicable.	
Field Loads	Not applicable.	
Temp Dependent Loads	Not applicable.	

LUSAS Output

Solver Stress (default): σ_x , σ_y , σ_z , σ_{xy} , σ_{yz} , σ_{xz} , σ_e : global stresses.
 Strain: ϵ_x , ϵ_y , ϵ_z , γ_{xy} , γ_{yz} , γ_{xz} , ϵ_e : global strains.
 Stretch (for rubber only): V11, V22, V33, V12, V23, V13, λ_1 , λ_2 , λ_3 , det F. Where V_{ii} are components of the left stretch tensors, λ_i the

principal stretches, $\theta\lambda$ the angle between the maximum principal stretch and the global X axis, and $\det F$ the determinant of the deformation gradient or volume ratio.

For optional principal stress/strain output, together with the corresponding direction cosines, use Option 77.

Modeller See [Results Tables \(Appendix K\)](#).

Local Axes

Not applicable (global axes are the reference).

Sign Convention

- Standard 3D continuum element

Formulation

Geometric Nonlinearity

Total Lagrangian For large displacements and large rotations.

Updated Lagrangian For large displacements and large rotations.

Eulerian

Eulerian For large displacements, large rotations and moderately large strains.

Co-rotational For large displacements and large rotations (large strains with the rubber material model).

Integration Schemes

Stiffness	Default.	2x2x2
	Fine.	As default.
Mass	Default.	2x2x2
	Fine.	As default.

Mass Modelling

- Consistent mass (default).
- Lumped mass.

Options

- 39** Stress smoothing for rubber material models.
- 54** Updated Lagrangian geometric nonlinearity.
- 55** Output strains as well as stresses.

- 77 Output principal stresses and direction cosines.
- 87 Total Lagrangian geometric nonlinearity.
- 102 Switch off load correction stiffness due to centripetal acceleration.
- 105 Lumped mass matrix.
- 139 Output yielded Gauss points only.
- 167 Eulerian geometric nonlinearity.
- 225 Use alternative number of parameters for enhanced strain interpolation (see *Notes*).
- 229 Co-rotational geometric nonlinearity.

Notes on Use

1. The element is based on the standard isoparametric approach. The variation of stresses within an element may be regarded as linear.
2. The strain field for this element consists of two parts: the compatible strains derived from the assumed displacement field and the assumed enhanced strains; see *LUSAS Theory Manual*. By default, 18 parameters are used to define the assumed enhanced strain. In general, the default number of parameters should be used. However, 9 parameters may be specified using Option 225. In most cases the use of 9 or 18 parameters will give an equivalent solution. However, in some instances a better response may be obtained using more parameters at the expense of increased computation time.
3. The element passes the [patch test](#) and the large strain patch test for rubber.
4. When using table input format for temperature dependent ORTHOTROPIC SOLID or ANISOTROPIC SOLID material properties, the value of nset used is that defined in the first line of the property table.
5. Non-conservative (follower) loading is available with these elements when using either Updated Lagrangian or Eulerian geometric nonlinear formulations together with the FLD loading facility. The load does not have to be normal to the face and may also vary over the face.
6. To apply a non-conservative (follower) pressure load (load type FLD) with co-rotational geometric nonlinearity, Option 36 must be specified. Note that this load must be normal to the face and constant for all the nodes of the element face.
7. The converged stresses for the rubber material model are [Kirchhoff](#) stresses (see *LUSAS Theory Manual*).
8. Option 39 is used to smooth the stress output. It is particularly useful when the rubber material model is applied and the element is under very high compression where oscillatory stresses may appear (checker-board pattern).
9. For the rubber material model, converged values for strain output are replaced by the left stretch tensor V , the principal stretches of the vectors defining these

principal directions. The principal stretches and directions can be obtained using Option 77. The value of $\det F = \lambda_1 \lambda_2 \lambda_3$ (the volume ratio) is only available for Gauss point output.

10. For the rubber material model, the iterative values of stress and strain are output in local co-rotated directions at the Gauss points only.
11. Convergence difficulties can sometimes arise when using enhanced strain elements with nonlinear materials, particularly if the material is elastic-perfectly plastic or if a very shallow hardening curve is defined. In such cases it is recommended that the standard element formulation is used.

Restrictions

- [Avoid excessive aspect ratio](#)
- Rubber material models can only be applied in conjunction with the co-rotational formulation, Option 229.

Recommendations on Use

This element exhibits an improved performance when compared with the parent element HX8. The integration rules are the same as the parent element. The HX8M element does not suffer from locking due to [parasitic shear](#) or when the material approaches the incompressible limit. No [zero energy modes](#) exist for this element.

3D Solid Continuum Crack Tip Elements

General

Element Name

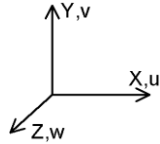

TH10K

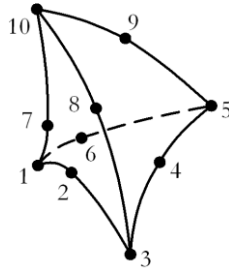

Crack specified at Node 1

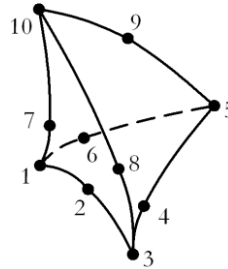

Crack specified along edge 1-2-3

PN15K

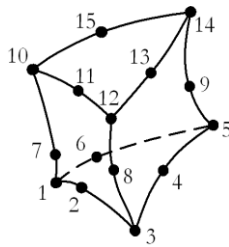

Crack specified at Node 1

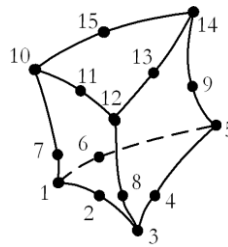

Crack specified along edge 1-2-3

HX20K

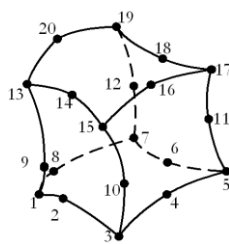

Crack specified at Node 1

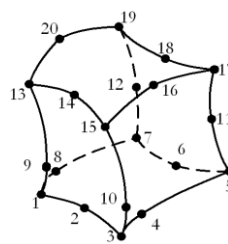

Crack specified along edge 1-2-3

Element Group
Element
Subgroup
Element
Description

3D Continuum
Solid Continuum

A family of 3D isoparametric crack tip elements where the crack tip can be located at any corner node or along any edge of an element. The mid-side nodes are moved to the quarter points to produce a singularity at the crack tip. The strains vary as the square root of

Number Of Nodes	1/R, where R is the distance from the crack tip. These elements are used at the crack tip only. The elements are numerically integrated. 10 (tetrahedra). 15 (pentahedra). 20 (hexahedra). The elements are numbered according to a right-hand screw rule in the local z-direction.
Freedom Node	U, V, W: at each node.
Coordinates	X, Y, Z: at each node.

Geometric Properties

Not applicable.

Material Properties

Linear	Isotropic:	MATERIAL PROPERTIES (Elastic: Isotropic)
	Orthotropic:	MATERIAL PROPERTIES ORTHOTROPIC SOLID (Elastic: Orthotropic Solid)
	Anisotropic:	MATERIAL PROPERTIES ANISOTROPIC SOLID (Elastic: Anisotropic Solid)
	Rigidities.	Not applicable.
Matrix	Not applicable.	
Joint	Not applicable.	
Concrete		MATERIAL PROPERTIES NONLINEAR 109 (Elastic: Isotropic, Plastic: Smoothed Multi-Crack Concrete)
Elasto-Plastic	Stress resultant:	Not applicable.
	Tresca:	MATERIAL PROPERTIES NONLINEAR 61 (Elastic: Isotropic, Plastic: Tresca, Hardening: Isotropic Hardening Gradient, Isotropic Plastic Strain or Isotropic Total Strain)
	Drucker-Prager:	MATERIAL PROPERTIES NONLINEAR 64 (Elastic: Isotropic, Plastic: Drucker-Prager, Hardening: Granular)
	Mohr-Coulomb:	MATERIAL PROPERTIES NONLINEAR 65 (Elastic: Isotropic, Plastic: Mohr-Coulomb, Hardening: Granular with Dilation)
	Modified Mohr-Coulomb:	MATERIAL PROPERTIES MODIFIED MOHR_COULOMB (Elastic: Isotropic, Plastic: Mohr-Coulomb/Tresca, non-associative Hardening with

		tension/compression cut-off)
	Modified Cam-clay	MATERIAL PROPERTIES CAM_CLAY MODIFIED (Elastic: Isotropic, Plastic)
	Optimised Implicit Von Mises:	MATERIAL PROPERTIES NONLINEAR 75 (Elastic: Isotropic, Plastic: Von Mises, Hardening: Isotropic & Kinematic)
	Volumetric Crushing:	MATERIAL PROPERTIES NONLINEAR 81 (Volumetric Crushing or Crushable Foam)
	Stress Potential:	STRESS POTENTIAL VON_MISES, HILL, HOFFMAN (Isotropic: von Mises, Modified von Mises Orthotropic: Hill, Hoffman)
	Creep	CREEP PROPERTIES (Creep)
	AASHTO	MATERIAL PROPERTIES NONLINEAR 86 AASHTO (Concrete creep model to AASHTO code of Practice)
	CEB-FIP	MATERIAL PROPERTIES NONLINEAR 86 CEB-FIP (Concrete creep model to CEB-FIP Model Code 1990)
	Chinese	MATERIAL PROPERTIES NONLINEAR 86 CHINESE (Chinese creep model to Chinese Code of Practice)
	Eurocode	MATERIAL PROPERTIES NONLINEAR 86 EUROCODE (Concrete creep model to EUROCODE_2)
	IRC	MATERIAL PROPERTIES NONLINEAR 86 IRC (Concrete creep model to Indian IRC code of Practice)
	Damage	DAMAGE PROPERTIES SIMO, OLIVER (Damage)
	Viscoelastic	VISCO ELASTIC PROPERTIES
	Shrinkage	SHRINKAGE CEB_FIP_90, EUROCODE_2, GENERAL, USER
Ko Initialisation	Applicable	
Elasto- Plastic Interface		MATERIAL PROPERTIES NONLINEAR 26

Rubber	Not applicable.	
Generic Polymer	Isotropic	MATERIAL PROPERTIES NONLINEAR 89 (Generic Polymer Model)
Composite	Not applicable	

Loading

Prescribed Value	PDSP, TPDSP	Prescribed variable. U, V, W: at each node.
Concentrated Loads	CL	Concentrated loads. Px, Py, Pz: at each node.
Element Loads	Not applicable.	
Distributed Loads	UDL	Not applicable.
	FLD	Face Loads. Px, Py, Pz: local face pressures at nodes.
	FLDG	Global Face Loads. $\sigma_x, \sigma_y, \sigma_z, \sigma_{xy}, \sigma_{yz}, \sigma_{xz}$ at nodes
Body Forces	CBF	Constant body forces for element. Xcbf, Ycbf, Zcbf, $\Omega_x, \Omega_y, \Omega_z, \alpha_x, \alpha_y, \alpha_z$
	BFP, BFPE	Body force potentials at nodes/for element. 0, 0, 0, $\phi_4, Xcbf, Ycbf, Zcbf$
Velocities	VELO	Velocities. Vx, Vy, Vz: at nodes.
Accelerations	ACCE	Acceleration Ax, Ay, Az: at nodes.
Viscous Support Loads	VSL	Viscous support loads. VLx, VLy, VLz: at nodes.
Initial Stress/Strains	SSI, SSIE	Initial stresses/strains at nodes/for element. $\sigma_x, \sigma_y, \sigma_z, \sigma_{xy}, \sigma_{yz}, \sigma_{xz}$: global stresses. $\epsilon_x, \epsilon_y, \epsilon_z, \gamma_{xy}, \gamma_{yz}, \gamma_{xz}$: global strains.
	SSIG	Initial stresses/strains at Gauss points $\sigma_x, \sigma_y, \sigma_z, \sigma_{xy}, \sigma_{yz}, \sigma_{xz}$: global stresses. $\epsilon_x, \epsilon_y, \epsilon_z, \gamma_{xy}, \gamma_{yz}, \gamma_{xz}$: global strains.
Residual Stresses	SSR, SSRE	Residual stresses at nodes/for element. $\sigma_x, \sigma_y, \sigma_z, \sigma_{xy}, \sigma_{yz}, \sigma_{xz}$: global stresses.
	SSRG	Residual stresses at Gauss points. $\sigma_x, \sigma_y, \sigma_z, \sigma_{xy}, \sigma_{yz}, \sigma_{xz}$ global stresses.
Target	TSSIE,	Target stresses/strains at nodes/for element. $\sigma_x,$

Stress/Strains	TSSIA	$\sigma_y, \sigma_z, \sigma_{xy}, \sigma_{yz}, \sigma_{xz}$: global stresses. $\epsilon_x, \epsilon_y, \epsilon_z, \gamma_{xy}, \gamma_{yz}, \gamma_{xz}$: global strains.
	TSSIG	Target stresses/strains at Gauss points $\sigma_x, \sigma_y, \sigma_z, \sigma_{xy}, \sigma_{yz}, \sigma_{xz}$: global stresses. $\epsilon_x, \epsilon_y, \epsilon_z, \gamma_{xy}, \gamma_{yz}, \gamma_{xz}$: global strains.
Temperatures	TEMP, TMPE	Temperatures at nodes/for element. T, 0, 0, 0, T ₀ , 0, 0, 0
Overburden	Applicable.	
Phreatic Surface	Applicable.	
Field Loads	Not applicable.	
Temp Dependent Loads	Not applicable.	

LUSAS Output

Solver	Stress (default): $\sigma_x, \sigma_y, \sigma_z, \sigma_{xy}, \sigma_{yz}, \sigma_{xz}, \sigma_e$: global stresses. Strain: $\epsilon_x, \epsilon_y, \epsilon_z, \gamma_{xy}, \gamma_{yz}, \gamma_{xz}, \epsilon_e$: global strains. For optional principal stress/strain output, together with the corresponding direction cosines, use Option 77.
Modeller	See Results Tables (Appendix K) .

Local Axes

Not applicable (global axes are the reference).

Sign Convention

- [Standard 3D continuum element](#)

Formulation

Geometric Nonlinearity

Total Lagrangian	For large displacements and large rotations.
Updated Lagrangian	For large displacements and large rotations.
Eulerian	For large displacements, large rotations and moderately large strains.
Co-rotational	For large displacements and large rotations.

Integration Schemes

Stiffness	Default.	4-point (TH10K), 6x3 (PN15K), 3x3x3 (HX20K)
	Fine (see <i>Options</i>).	11-point (TH10K), 12x4 (HX15K)
Mass	Default.	4-point (TH10K), 6x3 (PN15K), 3x3x3 (HX20K)
	Fine (see <i>Options</i>).	11-point (TH10K), 14-point (TH10K), 12x4 (HX15K)

Mass Modelling

- Consistent mass (default).
- Lumped mass.

Options

- 18** Invokes fine integration rule.
- 36** Follower loads
- 54** Updated Lagrangian geometric nonlinearity
- 55** Output strains as well as stresses.
- 77** Output principal stresses and direction cosines.
- 87** Total Lagrangian geometric nonlinearity.
- 91** Invoke finer integration of the mass matrix.
- 102** Switch off load correction stiffness due to centripetal acceleration.
- 105** Lumped mass matrix.
- 139** Output yielded Gauss points only.
- 167** Eulerian geometric nonlinearity.
- 229** Co-rotational geometric nonlinearity.
- 395** Use 14-point integration rule for mass matrix of TH10 (used together with Option 91).
- 398** For HX20 and HX16 with fine integration use all integration points for stress extrapolation.

Notes on Use

1. The elements are based on the standard isoparametric approach. Moving the mid-side nodes to the quarter points creates a singularity with theoretically infinite stress at the crack tip.
2. When using table input format for temperature dependent ORTHOTROPIC SOLID or ANISOTROPIC SOLID material properties, the value of nset used is that defined in the first line of the property table.

3. Non-conservative loading is available with these elements when using either Updated Lagrangian or Eulerian geometric nonlinear formulations together with the FLD loading facility.

Restrictions

- [Avoid excessive element curvature](#)
- Avoid excessive aspect ratio

Recommendations on Use

- The 3D solid crack tip elements should be used if the stress field is fully 3D, i.e. it cannot be approximated with any of the 2D crack tip elements.
- Elements TH10K, PN15K and HX20K are specifically designed for application to fracture mechanics problems and may be used to model the singularities that occur at the crack tip. The mid-side nodes near the crack tip are shifted to the quarter point. This ensures a singularity is present at the crack tip and that strains vary as $1/\sqrt{r}$ - where r is the distance from the crack tip.

3D Solid Continuum Composite Elements (Tetrahedral)

General

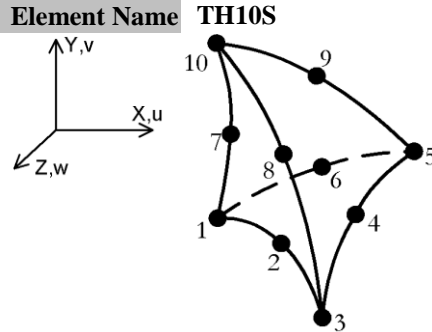

Element Group	3D Continuum
Element Subgroup	Solid Continuum
Element Description	A 3D tetrahedral element capable of modelling curved boundaries. The element can be arbitrarily oriented with respect to the laminate and allows for the fully automatic mesh generation of laminate geometric models imported from CAD packages.
Number Of Nodes	10. The element is numbered according to a right-hand screw rule in the local z-direction.
Freedom Node	U, V, W: at each node. X, Y, Z: at each node.
Coordinates	

Geometric Properties

See [Composites](#) in the *Modeller Reference Manual*

Material Properties

Linear	Isotropic:	MATERIAL PROPERTIES (Elastic: Isotropic)
	Orthotropic:	MATERIAL PROPERTIES ORTHOTROPIC SOLID (Elastic: Orthotropic Solid)
	Anisotropic:	MATERIAL PROPERTIES ANISOTROPIC SOLID (Elastic: Anisotropic Solid)
	Rigidities.	Not applicable.
Matrix	Not applicable.	
Joint	Not applicable.	

Concrete		MATERIAL PROPERTIES NONLINEAR 109 (Elastic: Isotropic, Plastic: Smoothed Multi-Crack Concrete)
Elasto-Plastic	Stress resultant:	Not applicable.
	Tresca:	MATERIAL PROPERTIES NONLINEAR 61 (Elastic: Isotropic, Plastic: Tresca, Hardening: Isotropic Hardening Gradient, Isotropic Plastic Strain or Isotropic Total Strain)
	Drucker-Prager:	MATERIAL PROPERTIES NONLINEAR 64 (Elastic: Isotropic, Plastic: Drucker-Prager, Hardening: Granular)
	Mohr-Coulomb:	MATERIAL PROPERTIES NONLINEAR 65 (Elastic: Isotropic, Plastic: Mohr-Coulomb, Hardening: Granular with Dilation)
	Modified Mohr-Coulomb:	MATERIAL PROPERTIES MODIFIED MOHR_COULOMB (Elastic: Isotropic, Plastic: Mohr-Coulomb/Tresca, non-associative Hardening with tension/compression cut-off)
	Volumetric Crushing:	Not applicable.
	Stress Potential	STRESS POTENTIAL VON_MISES, HILL, HOFFMAN (Isotropic: von Mises, Modified von Mises Orthotropic: Hill, Hoffman)
Creep	AASHTO	MATERIAL PROPERTIES NONLINEAR 86 AASHTO (Concrete creep model to AASHTO code of Practice)
	CEB-FIP	MATERIAL PROPERTIES NONLINEAR 86 CEB-FIP (Concrete creep model to CEB-FIP Model Code 1990)
	Chinese	MATERIAL PROPERTIES NONLINEAR 86 CHINESE (Chinese creep model to Chinese Code of Practice)
	Eurocode	MATERIAL PROPERTIES NONLINEAR 86 EUROCODE (Concrete creep model to EUROCODE_2)
	IRC	MATERIAL PROPERTIES NONLINEAR 86

		IRC (Concrete creep model to Indian IRC code of Practice)
Damage		DAMAGE PROPERTIES SIMO, OLIVER (Damage)
Viscoelastic Shrinkage		VISCO ELASTIC PROPERTIES SHRINKAGE CEB_FIP_90, EUROCODE_2, GENERAL, USER
Ko Initialisation	Not applicable	
Rubber	Not applicable.	
Generic Polymer Resin Cure Model		MATERIAL PROPERTIES NONLINEAR 89 (Generic Polymer Model) MATERIAL PROPERTIES NONLINEAR CURE LAYER, FIBRE_RESIN
Composite	Composite solid:	COMPOSITE PROPERTIES (Elastic: Orthotropic Solid)

Loading

Prescribed Value Concentrated Loads	PDSP, TPDSP CL	Prescribed variable. U, V, W: at each node. Concentrated loads. Px, Py, Pz: at each node.
Element Loads	Not applicable.	
Distributed Loads	UDL FLD FLDG	Not applicable. Face Loads. Px, Py, Pz: local face pressures at nodes. Global Face Loads. $\sigma_x, \sigma_y, \sigma_z, \sigma_{xy}, \sigma_{yz}, \sigma_{xz}$ at nodes
Body Forces	CBF BFP, BFPE	Constant body forces for element. Xcbf, Ycbf, Zcbf, $\Omega_x, \Omega_y, \Omega_z, \alpha_x, \alpha_y, \alpha_z$ Body force potentials at nodes/for element. 0, 0, 0, $\varphi_4, Xcbf, Ycbf, Zcbf$
Velocities	VELO	Velocities. Vx, Vy, Vz: at nodes.
Accelerations	ACCE	Acceleration Ax, Ay, Az: at nodes.
Viscous Support Loads	VSL	Viscous support loads. VLx, VLy, VLz: at nodes.
Initial Stress/Strains	SSI, SSIE	Initial stresses/strains at nodes/for element. $\sigma_x, \sigma_y, \sigma_z, \sigma_{xy}, \sigma_{yz}, \sigma_{xz}$: global stresses.

		$\epsilon_x, \epsilon_y, \epsilon_z, \gamma_{xy}, \gamma_{yz}, \gamma_{xz}$: global strains.
	SSIG	Initial stresses/strains at Gauss points (see <i>Notes</i>).
		$\sigma_x, \sigma_y, \sigma_z, \sigma_{xy}, \sigma_{yz}, \sigma_{xz}$: global stresses.
Residual Stresses	SSR, SSRE	$\epsilon_x, \epsilon_y, \epsilon_z, \gamma_{xy}, \gamma_{yz}, \gamma_{xz}$: global strains. Residual stresses at nodes/for element.
	SSRG	$\sigma_x, \sigma_y, \sigma_z, \sigma_{xy}, \sigma_{yz}, \sigma_{xz}$: global stresses. Residual stresses at Gauss points (see <i>Notes</i>).
Target Stress/Strains	TSSIE, TSSIA	$\sigma_x, \sigma_y, \sigma_z, \sigma_{xy}, \sigma_{yz}, \sigma_{xz}$ global stresses. Target stresses/strains at nodes/for element.
	TSSIG	$\epsilon_x, \epsilon_y, \epsilon_z, \gamma_{xy}, \gamma_{yz}, \gamma_{xz}$: global strains. Target stresses/strains at Gauss points (see <i>Notes</i>).
		$\sigma_x, \sigma_y, \sigma_z, \sigma_{xy}, \sigma_{yz}, \sigma_{xz}$: global stresses.
Temperatures	TEMP, TMPE	$\epsilon_x, \epsilon_y, \epsilon_z, \gamma_{xy}, \gamma_{yz}, \gamma_{xz}$: global strains. Temperatures at nodes/for element. T, 0, 0, 0, To, 0, 0, 0
Overburden	Applicable.	
Phreatic Surface	Applicable.	
Field Loads	Not applicable.	
Temp Dependent Loads	Not applicable.	

LUSAS Output

Solver	Stress (default): $\sigma_x, \sigma_y, \sigma_z, \sigma_{xy}, \sigma_{yz}, \sigma_{xz}$: local stresses. Strain: $\epsilon_x, \epsilon_y, \epsilon_z, \gamma_{xy}, \gamma_{yz}, \gamma_{xz}$: local strains. Stresses and strains are output at the Gauss and corner points of the subdivision(s) of each layer. For optional principal stress/strain output, together with the corresponding direction cosines, use Option 77.
Modeller	See Results Tables (Appendix K) .

Local Axes

The local axes for each layer are defined by the LAMINAR DIRECTIONS specified for its bottom surface. The three node set in LAMINAR DIRECTIONS define the local

Cartesian set origin, the x-axis and the positive quadrant of the xy-plane respectively. The local z-axis forms an orthonormal coordinate system with x and y.

Sign Convention

- Standard 3D continuum element

Formulation

Geometric Nonlinearity

Total Lagrangian	Not applicable.
Updated Lagrangian	Not applicable.
Eulerian	Not applicable.
Co-rotational	For large displacements and large rotations.

Integration Schemes

Stiffness	Default.	1-point for a tetrahedral subdivision (see Notes), 3-point for a pentahedral/pyramid subdivision, 2x2 for a hexahedral/wrick subdivision
	Fine (see <i>Options</i>).	1-point for a tetrahedral subdivision (see Notes), 3x2 for a pentahedral/pyramid subdivision, 2x2 x2 for a hexahedral/wrick subdivision
Mass	Default	5-point for the whole element or (see Options) 1-point for a tetrahedral subdivision, 3x2 for a pentahedral/pyramid subdivision, 2x2 x2 for a hexahedral/wrick subdivision
	Fine (see <i>Options</i>).	11-point or (see Options) 14 -point for the whole element

Mass Modelling

- Consistent mass (default).
- Lumped mass.

Options

- 18** Invokes fine integration rule.
- 36** Follower loads.
- 55** Output strains as well as stresses.
- 77** Output principal stresses and direction cosines.
- 91** Formulate element mass with fine integration.
- 105** Lumped mass matrix.

- 139 Output yielded Gauss points only.
- 229 Co-rotational geometric nonlinearity.
- 266 Layer by layer computation of mass matrix.
- 394 Lamina directions supported.
- 395 Use 14-point fine integration rule for mass matrix of TH10 family (used together with 91).

Notes on Use

1. The element is based on the standard isoparametric approach. The variation of strains within an element may be regarded as linear.
2. All elements pass the [patch test](#).
3. The LAMINAR DIRECTIONS and COMPOSITE PROPERTIES data chapters must be used with this element in conjunction with the COMPOSITE ASSIGNMENTS data chapter.
4. The stresses obtained from a geometric nonlinear analysis are [Kirchhoff](#) stresses.
5. If the whole tetrahedral element is embedded in a single lamina, a 4-point integration rule will be used for this tetrahedral subdivision; otherwise a 1-point rule will be used.
6. The mass matrix can be computed using a layer by layer integration (OPTION 266), however this should only be used when the densities of the layers vary considerably because the computation time can be greatly increased when this OPTION is specified.
7. Numerical integration through the thickness is performed. The integration points are located in the subdivisions of each layer. Each subdivision forms the shape of a regular 3D solid continuum element and the integration points are located accordingly within the subdivision as described above.
8. SSIG and SSRG loads have to be applied at the Gauss point positions for the subdivision(s) of each layer.
9. Layer 1 is always the bottom layer.

Restrictions

- [Ensure mid-side node centrality](#)
- [Avoid excessive element curvature](#)
- Avoid excessive aspect ratio

Recommendations on Use

- 3D solid composite elements should be used for modelling thick composite structures comprising laminae of differing material properties where the computational cost of modelling each lamina with an individual solid element would be prohibitive.
- As these elements can be arbitrarily oriented with respect to the laminate, they are particularly aimed at the use of fully automatic mesh generation of laminate geometric models imported from CAD packages.

3D Solid Continuum Composite Elements (Pentahedral and Hexahedral)

General

Element Name PN6L

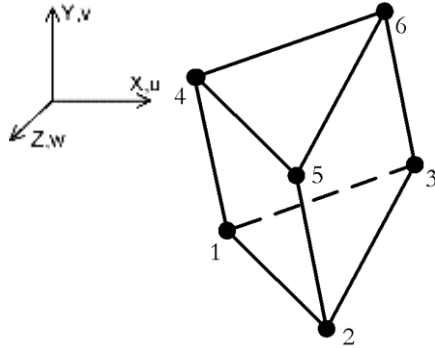

Element Name PN12L

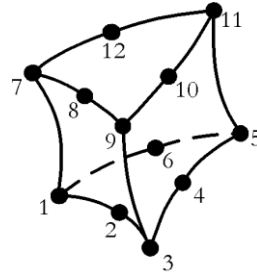

Element Name HX8L

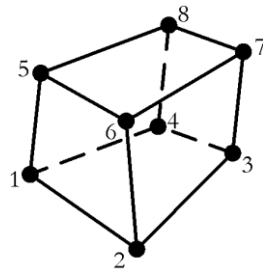

Element Name HX16L

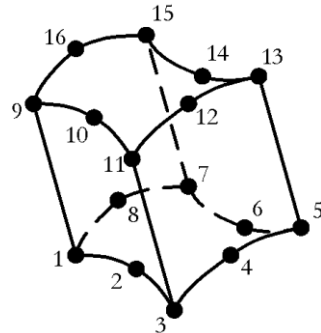

Element Group 3D Continuum
Element Subgroup Solid Continuum

Element Description 3D isoparametric pentahedral and hexahedral solid elements with higher order models capable of modelling curved boundaries. The element can be used to model a laminate, where lamina planes are defined by the top and bottom surfaces of the element. The elements are numerically integrated.

Number Of Nodes 6 or 12 (pentahedra), 8 or 16 (hexahedra). The elements are numbered according to a right-hand screw rule in the local z-direction.

Freedoms Node U, V, W: at each node.
 X, Y, Z: at each node.

Coordinates

Geometric Properties

See [Composites](#) in the *Modeller Reference Manual*

Material Properties

Linear	Isotropic:	MATERIAL PROPERTIES (Elastic: Isotropic)
	Orthotropic:	MATERIAL PROPERTIES ORTHOTROPIC SOLID (Elastic: Orthotropic Solid)
	Anisotropic:	MATERIAL PROPERTIES ANISOTROPIC SOLID (Elastic: Anisotropic Solid)
	Rigidities:	Not applicable.
Matrix	Not applicable.	
Joint	Not applicable.	
Concrete		MATERIAL PROPERTIES NONLINEAR 109 (Elastic: Isotropic, Plastic: Smoothed Multi-Crack Concrete)
Elasto-Plastic	Stress resultant:	Not applicable.
	Tresca:	MATERIAL PROPERTIES NONLINEAR 61 (Elastic: Isotropic, Plastic: Tresca, Hardening: Isotropic Hardening Gradient, Isotropic Plastic Strain or Isotropic Total Strain)
	Drucker-Prager:	MATERIAL PROPERTIES NONLINEAR 64 (Elastic: Isotropic, Plastic: Drucker-Prager, Hardening: Granular)
	Mohr-Coulomb:	MATERIAL PROPERTIES NONLINEAR 65 (Elastic: Isotropic, Plastic: Mohr-Coulomb, Hardening: Granular with Dilation)
	Modified Mohr-Coulomb:	MATERIAL PROPERTIES MODIFIED MOHR_COULOMB (Elastic: Isotropic, Plastic: Mohr-Coulomb/Tresca, non-associative Hardening with tension/compression cut-off)
	Volumetric Crushing:	Not applicable.
	Stress Potential	STRESS POTENTIAL VON_MISES, HILL, HOFFMAN (Isotropic: von Mises, Modified von Mises Orthotropic: Hill, Hoffman)

Creep	AASHTO	MATERIAL PROPERTIES NONLINEAR 86 AASHTO (Concrete creep model to AASHTO code of Practice)
	CEB-FIP	MATERIAL PROPERTIES NONLINEAR 86 CEB-FIP (Concrete creep model to CEB-FIP Model Code 1990)
	Chinese	MATERIAL PROPERTIES NONLINEAR 86 CHINESE (Chinese creep model to Chinese Code of Practice)
	Eurocode	MATERIAL PROPERTIES NONLINEAR 86 EUROCODE (Concrete creep model to EUROCODE_2)
	IRC	MATERIAL PROPERTIES NONLINEAR 86 IRC (Concrete creep model to Indian IRC code of Practice)

Damage DAMAGE PROPERTIES SIMO, OLIVER (Damage)

Viscoelastic Shrinkage VISCO ELASTIC PROPERTIES SHRINKAGE CEB_FIP_90, EUROCODE_2, GENERAL, USER

Ko Initialisation Not applicable

Rubber Not applicable.

Generic Polymer MATERIAL PROPERTIES NONLINEAR 89 (Generic Polymer Model)

Resin Cure Model MATERIAL PROPERTIES NONLINEAR CURE LAYER, FIBRE_RESIN

Composite Composite solid: COMPOSITE PROPERTIES (Elastic: Orthotropic Solid)

Loading

Prescribed Value	PDSP, TPDSP	Prescribed variable. U, V, W: at each node.
Concentrated Loads	CL	Concentrated loads. Px, Py, Pz: at each node.
Element Loads	Not	

		applicable.
Distributed Loads	UDL	Not applicable.
	FLD	Face Loads. Px, Py, Pz: local face pressures at nodes.
	FLDG	Global Face Loads. $\sigma_x, \sigma_y, \sigma_z, \sigma_{xy}, \sigma_{yz}, \sigma_{xz}$ at nodes
Body Forces	CBF	Constant body forces for element. Xcbf, Ycbf, Zcbf, $\Omega_x, \Omega_y, \Omega_z, \alpha_x, \alpha_y, \alpha_z$
	BFP, BFPE	Body force potentials at nodes/for element. 0, 0, 0, $\phi_4, Xcbf, Ycbf, Zcbf$
Velocities	VELO	Velocities. Vx, Vy, Vz: at nodes.
Accelerations	ACCE	Acceleration Ax, Ay, Az: at nodes.
Viscous Support Loads	VSL	Viscous support loads. VLx, VLy, VLz: at nodes.
Initial Stress/Strains	SSI, SSIE	Initial stresses/strains at nodes/for element. $\sigma_x, \sigma_y, \sigma_z, \sigma_{xy}, \sigma_{yz}, \sigma_{xz}$: global stresses. $\epsilon_x, \epsilon_y, \epsilon_z, \gamma_{xy}, \gamma_{yz}, \gamma_{xz}$: global strains.
	SSIG	Initial stresses/strains at Gauss points (see <i>Notes</i>). $\sigma_x, \sigma_y, \sigma_z, \sigma_{xy}, \sigma_{yz}, \sigma_{xz}$: global stresses. $\epsilon_x, \epsilon_y, \epsilon_z, \gamma_{xy}, \gamma_{yz}, \gamma_{xz}$: global strains.
Residual Stresses	SSR, SSRE	Residual stresses at nodes/for element. $\sigma_x, \sigma_y, \sigma_z, \sigma_{xy}, \sigma_{yz}, \sigma_{xz}$: global stresses.
	SSRG	Residual stresses at Gauss points (see <i>Notes</i>). $\sigma_x, \sigma_y, \sigma_z, \sigma_{xy}, \sigma_{yz}, \sigma_{xz}$: global stresses.
Target Stress/Strains	TSSIE, TSSIA	Target stresses/strains at nodes/for element. $\sigma_x, \sigma_y, \sigma_z, \sigma_{xy}, \sigma_{yz}, \sigma_{xz}$: global stresses. $\epsilon_x, \epsilon_y, \epsilon_z, \gamma_{xy}, \gamma_{yz}, \gamma_{xz}$: global strains.
	TSSIG	Target stresses/strains at Gauss points (see <i>Notes</i>). $\sigma_x, \sigma_y, \sigma_z, \sigma_{xy}, \sigma_{yz}, \sigma_{xz}$: global stresses. $\epsilon_x, \epsilon_y, \epsilon_z, \gamma_{xy}, \gamma_{yz}, \gamma_{xz}$: global strains.
Temperatures	TEMP, TMPE	Temperatures at nodes/for element. T, 0, 0, 0, To, 0, 0, 0
Overburden	Applicable.	
Phreatic Surface	Applicable.	
Field Loads	Not applicable.	

Temp Dependent Not
Loads applicable.

LUSAS Output

Solver Stress (default): σ_x , σ_y , σ_z , σ_{xy} , σ_{yz} , σ_{xz} : local stresses.
Strain: ϵ_x , ϵ_y , ϵ_z , γ_{xy} , γ_{yz} , γ_{xz} : local strains.
Stresses and strains are output at the top and bottom of each layer.
For optional principal stress/strain output, together with the corresponding direction cosines, use Option 77.

Modeller See [Results Tables \(Appendix K\)](#).

Local Axes

The local axes for each layer are defined using the convention for [standard area elements](#). Local axes are computed at the top and bottom surfaces (at the Gauss points) and average values are interpolated for the mid-surface. The top and bottom faces of the element are as shown, e.g. nodes 1, 2, 3, 4 define the bottom face of HX8L. Every layer uses the same averaged values.

Sign Convention

- [Standard 3D continuum element](#)

Formulation

Geometric Nonlinearity

Total Lagrangian Not applicable.
Updated Lagrangian Not applicable.
Eulerian Not applicable.
Co-rotational For large displacements and large rotations.

Integration Schemes

Stiffness Default. 1-point for each layer (PN6L), 3-point for each layer (PN12L), 2x2 for each layer (HX8L,HX16L)
Fine (see *Options*). 3-point for each layer (PN6L), 3x3 for each layer (HX16L)
Mass Default 3x2 for the whole element (PN6L,PN12L) or (see Options) 1-

point for each layer (PN6L), 3-point for each layer (PN12L), 2x2x2 for the whole element or 2x2 for each layer (HX8L, HX16L)

Fine (see 3x2 for the whole element or 3-point for each layer
Options). (PN6L), 3x3x2 for the whole element or 3x3 for each layer (HX16L)

Mass Modelling

- Consistent mass (default).
- Lumped mass.

Options

- 18** Invokes fine integration rule.
- 36** Follower loads.
- 55** Output strains as well as stresses.
- 77** Output principal stresses and direction cosines.
- 105** Lumped mass matrix.
- 139** Output yielded Gauss points only.
- 229** Co-rotational geometric nonlinearity.
- 266** Layer by layer computation of mass matrix.
- 303** Exclude incompatible modes for solid composite elements.

Notes on Use

1. The elements are based on the standard isoparametric approach. The variation of stresses within an element may be regarded as constant for the lower order elements (corner nodes only), and linear in the plane of the quadratic element faces for the higher order elements.
2. All elements pass the [patch test](#).
3. The COMPOSITE GEOMETRY and COMPOSITE PROPERTIES data chapters must be used with this element in conjunction with the COMPOSITE ASSIGNMENTS data chapter.
4. The stresses obtained from a geometric nonlinear analysis are [Kirchhoff](#) stresses.
5. The mass matrix can be computed using a layer by layer integration (Option 266), however this should only be used when the densities of the layers vary considerably because the computation time can be greatly increased applying this option.
6. Numerical integration through the thickness is performed. The integration points are located at the top and bottom surface of each layer.

7. SSIG and SSRG loads have to be applied at the Gauss point positions for the top and bottom surfaces of each layer.
8. Layer 1 is always the bottom layer.

Restrictions

- [Ensure mid-side node centrality](#)
- [Avoid excessive element curvature](#)
- Avoid excessive aspect ratio

Recommendations on Use

- The 3D solid composite elements should be used for modelling thick composite structures comprising laminae of differing material properties where the computational cost of modelling each lamina with an individual solid element would be prohibitive.
- Because of the numerical integration through the thickness, by increasing the number of layers the accuracy of solution will increase. This can be achieved by dividing each single layer into two or three identical layers.

3D Solid Continuum Explicit Dynamics Elements

General

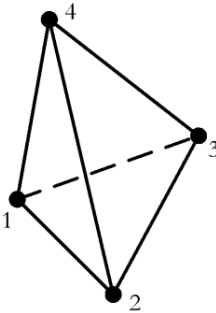
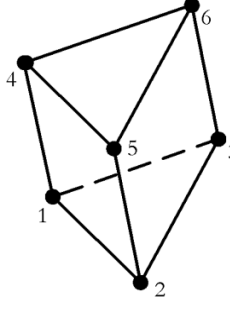
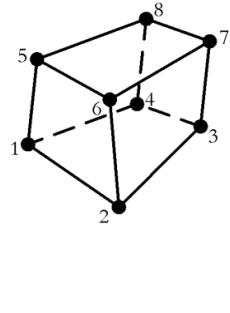
Element Name	TH4E	PN6E	HX8E
			
Element Group	3D Continuum		
Element Subgroup	Solid Continuum		
Element Description	A family of 3D isoparametric solid elements for explicit dynamic analyses. The elements are numerically integrated.		
Number Of Nodes	4 (tetrahedra), 6 (pentahedra), 8 (hexahedra). The elements are numbered according to a right-hand screw rule in the local z-direction.		
Freedom Node Coordinates	U, V, W: at each node. X, Y, Z: at each node.		

Geometric Properties

Not applicable.

Material Properties

Linear	.. Isotropic:	MATERIAL PROPERTIES (Elastic: Isotropic)
	Orthotropic:	MATERIAL PROPERTIES ORTHOTROPIC SOLID (Elastic: Orthotropic Solid)
	Anisotropic:	Not applicable.
	Rigidities:	Not applicable.
Matrix	Not applicable	
Joint	Not applicable	

Concrete	Not applicable	
Elasto-Plastic	Stress resultant: Tresca:	Not applicable. MATERIAL PROPERTIES NONLINEAR 61 (Elastic: Isotropic, Plastic: Tresca, Hardening: Isotropic Hardening Gradient, Isotropic Plastic Strain or Isotropic Total Strain)
	Drucker-Prager:	MATERIAL PROPERTIES NONLINEAR 64 (Elastic: Isotropic, Plastic: Drucker-Prager, Hardening: Granular)
	Mohr-Coulomb:	MATERIAL PROPERTIES NONLINEAR 65 (Elastic: Isotropic, Plastic: Mohr-Coulomb, Hardening: Granular with Dilation)
	Modified Mohr-Coulomb:	MATERIAL PROPERTIES MODIFIED MOHR_COULOMB (Elastic: Isotropic, Plastic: Mohr-Coulomb/Tresca, non-associative Hardening with tension/compression cut-off)
	Modified Cam-clay	MATERIAL PROPERTIES CAM_CLAY MODIFIED (Elastic: Isotropic, Plastic)
	Optimised Implicit Von Mises:	MATERIAL PROPERTIES NONLINEAR 75 (Elastic: Isotropic, Plastic: Von Mises, Hardening: Isotropic & Kinematic)
	Volumetric Crushing:	MATERIAL PROPERTIES NONLINEAR 81 (Volumetric Crushing or Crushable Foam)
	Stress Potential	STRESS POTENTIAL VON_MISES, HILL, HOFFMAN (Isotropic: von Mises, Modified von Mises Orthotropic: Hill, Hoffman)
Creep		CREEP PROPERTIES (Creep) (see <i>Notes</i>)
Damage		DAMAGE PROPERTIES SIMO, OLIVER (Damage)
Viscoelastic		VISCO ELASTIC PROPERTIES
Shrinkage	Not applicable	
Ko Initialisation	Not applicable	
Rubber	Not applicable	
Generic Polymer	Not applicable	
Composite	Not applicable	

applicable

Loading

Prescribed Value	PDSP, TPDSP	Prescribed variable. U, V, W: at each node.
Concentrated Loads	CL	Concentrated loads. Px, Py, Pz: at each node.
Element Loads	Not applicable.	
Distributed Loads	UDL FLD FLDG	Not applicable. Face Loads . Px, Py, Pz: local face pressures at nodes. Not applicable
Body Forces	CBF BFP, BFPE	Constant body forces for element. Xcbf, Ycbf, Zcbf, Ω_x , Ω_y , Ω_z , α_x , α_y , α_z Body force potentials at nodes/for element. 0, 0, 0, ϕ_4 , Xcbf, Ycbf, Zcbf
Velocities	VELO	Velocities. Vx, Vy, Vz: at nodes.
Accelerations	ACCE	Acceleration Ax, Ay, Az: at nodes.
Viscous Support Loads	VSL	Viscous support loads. VLx, VLy, VLz: at nodes.
Initial Stress/Strains	SSI, SSIE SSIG	Initial stresses/strains at nodes/for element. σ_x , σ_y , σ_z , σ_{xy} , σ_{yz} , σ_{xz} : global stresses. ϵ_x , ϵ_y , ϵ_z , γ_{xy} , γ_{yz} , γ_{xz} : global strains. Not applicable.
Residual Stresses	SSR, SSRE SSRG	Residual stresses at nodes/for element. σ_x , σ_y , σ_z , σ_{xy} , σ_{yz} , σ_{xz} : global stresses. Residual stresses at Gauss points. σ_x , σ_y , σ_z , σ_{xy} , σ_{yz} , σ_{xz} : global stresses.
Target Stress/Strains	Not applicable.	
Temperatures	TEMP, TMPE	Temperatures at nodes/for element. T, 0, 0, 0, To, 0, 0, 0
Overburden	Not applicable.	
Phreatic Surface	Not applicable.	
Field Loads	Not applicable.	

Temp Dependent Not
Loads applicable.

LUSAS Output

Solver Stress(default): σ_x , σ_y , σ_z , σ_{xy} , σ_{yz} , σ_{xz} , σ_e : global stresses.
Strain: not available (see *Notes*).
For optional principal stress output, together with the corresponding direction cosines, use Option 77.

Modeller See [Results Tables \(Appendix K\)](#).

Local Axes

Not applicable (global axes are the reference).

Sign Convention

- [Standard 3D continuum element](#)

Formulation

Geometric Nonlinearity

Total Lagrangian Not applicable.
Updated Lagrangian Not applicable.
Eulerian For large displacements, large rotations and moderately large strains.
Co-rotational For large displacements and large rotations.

Integration Schemes

Stiffness Default. 1-point (see *Notes*).
Fine. As default.
Mass Default. 1-point (see *Notes*).
Fine. As default.

Mass Modelling

- Lumped mass only (see *Notes*).

Options

- 77 Output principal stresses and direction cosines.
- 105 Lumped mass matrix.
- 139 Output yielded Gauss points only.

Notes on Use

1. The elements are based on the standard isoparametric approach. Stresses within an element may be regarded as constant.
2. When using tabular input for ORTHOTROPIC SOLID the value of nset used is that defined in the first line of the property table.
3. The system parameter HGVISC is used to restrict element mechanisms due to under-integration. The default value is usually sufficient.
4. The bulk viscosity coefficients are used to restrict numerical oscillations due to the traversal of stress waves. The default bulk viscosity coefficients (BULKLF and BULKQF) may be altered as SYSTEM parameters.
5. These elements must be used with a dynamic central difference scheme and a lumped mass matrix.
6. These element are Not applicable. for static or eigenvalue analyses.
7. Automatic time step length calculations are implemented.
8. As element geometry is always updated in an explicit dynamic analysis, the solution is nonlinear. When using explicit dynamic elements NONLINEAR CONTROL must be specified.
9. If CREEP PROPERTIES are defined, explicit time integration must be specified in VISCOUS CONTROL.
10. Strains are computed incrementally and therefore total strains are not available for output.
11. Non-conservative loading is invoked when the FLD loading facility is applied.
12. Rayleigh damping coefficients are not supported by these elements.
13. Constraint equations are not available for use with these elements.

Restrictions

- [Avoid excessive aspect ratio](#)

Recommendations on Use

- Explicit dynamics elements may be used to define surface boundaries which will be active in a slideline analysis.

- The 3D explicit dynamics elements should be used if the stress field is fully 3D, i.e. it cannot be approximated with any of the 2D elements, e.g. a non-axisymmetric pressure vessel.

3D Solid Two Phase Continuum Elements

General

Element Name

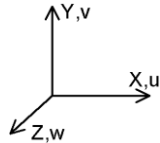

TH10P

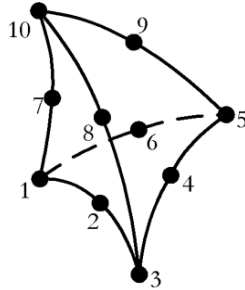

PN12P

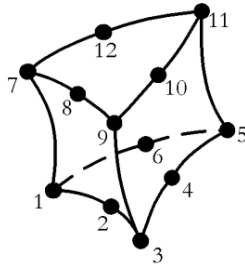

PN15P

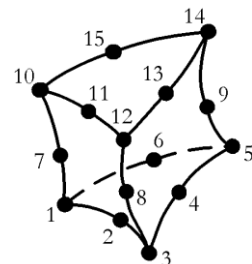

HX16P

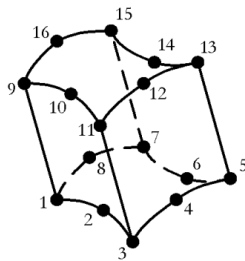

HX20P

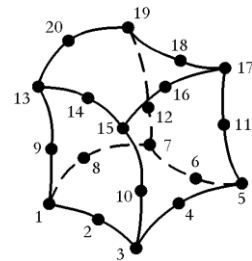

Element Group

3D Continuum

Element

Solid Continuum

Subgroup

Element Description

A family of 3D isoparametric solid two phase continuum elements capable of modelling curved boundaries. The elements are numerically integrated.

Number Of Nodes

10 (tetrahedra). 12 or 15 (pentahedra). 16 or 20 (hexahedra). The elements are numbered according to a right-hand screw rule in the local z-direction.

Freedoms	U, V, W, P: at corner nodes, U, V, W at mid-side nodes.
Node	X, Y, Z: at each node.
Coordinates	

Geometric Properties

Not applicable.

Material Properties

Linear	Isotropic:	MATERIAL PROPERTIES (Elastic: Isotropic)
	Orthotropic:	MATERIAL PROPERTIES ORTHOTROPIC SOLID (Elastic: Orthotropic Solid)
	Anisotropic:	MATERIAL PROPERTIES ANISOTROPIC SOLID (Elastic: Anisotropic Solid)
	Rigidities:	Not applicable.
Matrix	Not applicable.	
Joint	Not applicable.	
Concrete		MATERIAL PROPERTIES NONLINEAR 109 (Elastic: Isotropic, Plastic: Smoothed Multi-Crack Concrete)
Elasto-Plastic	Stress resultant:	Not applicable.
	Tresca:	MATERIAL PROPERTIES NONLINEAR 61 (Elastic: Isotropic, Plastic: Tresca, Hardening: Isotropic Hardening Gradient, Isotropic Plastic Strain or Isotropic Total Strain)
	Drucker-Prager:	MATERIAL PROPERTIES NONLINEAR 64 (Elastic: Isotropic, Plastic: Drucker-Prager, Hardening: Granular)
	Mohr-Coulomb:	MATERIAL PROPERTIES NONLINEAR 65 (Elastic: Isotropic, Plastic: Mohr-Coulomb, Hardening: Granular with Dilation)
	Modified Mohr-Coulomb:	MATERIAL PROPERTIES MODIFIED MOHR_COULOMB (Elastic: Isotropic, Plastic: Mohr-Coulomb/Tresca, non-associative Hardening with tension/compression cut-off)
	Modified Cam-clay	MATERIAL PROPERTIES CAM_CLAY MODIFIED (Elastic: Isotropic, Plastic)
	Optimised Implicit Von	MATERIAL PROPERTIES NONLINEAR 75 (Elastic: Isotropic, Plastic: Von Mises,

	Mises:	Hardening: Isotropic & Kinematic)
	Volumetric	MATERIAL PROPERTIES NONLINEAR 81
	Crushing:	(Volumetric Crushing or Crushable Foam)
	Stress	STRESS POTENTIAL VON_MISES, HILL,
	Potential:	HOFFMAN
		(Isotropic: von Mises, Modified von Mises
		Orthotropic: Hill, Hoffman)
	Creep	CREEP PROPERTIES (Creep)
	Damage	DAMAGE PROPERTIES SIMO, OLIVER
		(Damage)
	Viscoelastic	VISCO ELASTIC PROPERTIES
	Shrinkage	SHRINKAGE CEB_FIP_90, EUROCODE_2,
		GENERAL, USER
Ko Initialisation	Applicable	
Elasto- Plastic		MATERIAL PROPERTIES NONLINEAR 26
Interface		
Rubber	Not applicable.	
Generic Polymer	Isotropic	MATERIAL PROPERTIES NONLINEAR 89
		(Generic Polymer Model)
Composite	Not applicable	
Loading		
Prescribed Value	PDSP, TPDSP	Prescribed variable. U, V, W, P: at corner nodes, U, V, W at mid-side nodes.
Concentrated Loads	CL	Concentrated loads. Px, Py, Pz, Q: at corner nodes, .Px, Py, Pz at mid-side nodes.
Element Loads	Not applicable.	
Distributed Loads	UDL	Not applicable.
	FLD	Face Loads. Px, Py, Pz, Q: face pressures/flux per unit area at corner nodes relative to local face axes. Px, Py, Pz: face pressures at midside nodes relative to local face axes.
	FLDG	Global Face Loads. σ_x , σ_y , σ_z , σ_{xy} , σ_{yz} , σ_{xz} at nodes
Body Forces	CBF	Constant body forces for element. Xcbf, Ycbf, Zcbf, Ω_x , Ω_y , Ω_z , α_x , α_y , α_z , gx, gy, gz.

		(See notes on use)
	BFP, BFPE	Body force potentials at nodes/for element. 0, 0, 0, ϕ_4 , Xcbf, Ycbf, Zcbf, gx, gy, gz. (See notes on use)
Velocities	VELO	Velocities. Vx, Vy, Vz: at nodes.
Accelerations	ACCE	Acceleration Ax, Ay, Az: at nodes.
Viscous Support Loads	VSL	Viscous support loads. VLx, VLy, VLz: at nodes.
Initial Stress/Strains	SSI, SSIE	Initial stresses/strains at nodes/for element. σ_x , σ_y , σ_z , σ_{xy} , σ_{yz} , σ_{xz} , σ_p global stresses. ϵ_x , ϵ_y , ϵ_z , γ_{xy} , γ_{yz} , γ_{xz} : global strains.
	SSIG	Initial stresses/strains at Gauss points σ_x , σ_y , σ_z , σ_{xy} , σ_{yz} , σ_{xz} , σ_p : global stresses. ϵ_x , ϵ_y , ϵ_z , γ_{xy} , γ_{yz} , γ_{xz} : global strains.
Residual Stresses	SSR, SSRE	Residual stresses at nodes/for element. σ_x , σ_y , σ_z , σ_{xy} , σ_{yz} , σ_{xz} , σ_p : global stresses.
	SSRG	Residual stresses at Gauss points. σ_x , σ_y , σ_z , σ_{xy} , σ_{yz} , σ_{xz} , σ_p global stresses.
Target Stress/Strains	TSSIE, TSSIA	Target stresses/strains at nodes/for element. σ_x , σ_y , σ_z , σ_{xy} , σ_{yz} , σ_{xz} , σ_p global stresses. ϵ_x , ϵ_y , ϵ_z , γ_{xy} , γ_{yz} , γ_{xz} : global strains.
	TSSIG	Target stresses/strains at Gauss points σ_x , σ_y , σ_z , σ_{xy} , σ_{yz} , σ_{xz} , σ_p : global stresses. ϵ_x , ϵ_y , ϵ_z , γ_{xy} , γ_{yz} , γ_{xz} : global strains.
Temperatures	TEMP, TMPE	Temperatures at nodes/for element. T, 0, 0, 0, To, 0, 0, 0
Overburden	Applicable.	
Phreatic Surface	Applicable.	
Field Loads	Not applicable.	
Temp Dependent Loads	Not applicable.	

LUSAS Output

Solver Stress (default): σ_x , σ_y , σ_z , σ_{xy} , σ_{yz} , σ_{xz} , σ_p , σ_e : global stresses.

Strain: $\epsilon_x, \epsilon_y, \epsilon_z, \gamma_{xy}, \gamma_{yz}, \gamma_{xz}, \epsilon_v, \epsilon_e$: global strains.

For optional principal stress/strain output, together with the corresponding direction cosines, use Option 77.

Modeller See [Results Tables \(Appendix K\)](#).

Local Axes

Not applicable (global axes are the reference).

Sign Convention

- Standard 3D continuum element

Formulation

Geometric Nonlinearity

Total Lagrangian	For large displacements and large rotations.
Updated Lagrangian	For large displacements and large rotations.
Eulerian	For large displacements, large rotations and moderately large strains.
Co-rotational	For large displacements and large rotations.

Integration Schemes

Stiffness	Default.	4-point (TH10P), 3x2 (PN12P, PN15P), 2x2x2 (HX16P, HX20P)
	Fine (see <i>Options</i>).	5-point (TH10P), 3x3x2 (HX16P), 3x3x3 (HX20P)
	Coarse (see <i>Options</i>)	13-point (HX20P), 14-point (HX20P)
Mass	Default.	4-point (TH10P), 3x2 (PN12P, PN15P), 2x2x2 (HX16P, HX20P)
	Fine (see <i>Options</i>).	11-point (TH10P), 14-point (TH10P), 3x3x2 (HX16P), 3x3x3 (HX20P)
	Coarse (see <i>Options</i>)	13-point (HX20P), 14-point (HX20P)

Mass Modelling

- Consistent mass (default).
- Lumped mass.

Options

- 18** Invokes fine integration rule.
- 36** Follower loads
- 54** Updated Lagrangian geometric nonlinearity
- 55** Output strains as well as stresses.
- 77** Output principal stresses and direction cosines.
- 87** Total Lagrangian geometric nonlinearity.
- 91** Invoke finer integration of the mass matrix.
- 102** Switch off load correction stiffness due to centripetal acceleration.
- 105** Lumped mass matrix.
- 139** Output yielded Gauss points only.
- 155** Use 14-point integration rule for HX20P.
- 156** Use 13-point integration rule for HX20P.
- 167** Eulerian geometric nonlinearity.
- 229** Co-rotational geometric nonlinearity.
- 398** For HX20P and HX16P with fine integration use all integration points for stress extrapolation.

Notes on Use

1. Two phase material parameters must be used with these elements for undrained and consolidation analysis.
2. The elements are based on the standard isoparametric approach. The variation of stresses and pore pressures within an element may be regarded linear, except for elements PN12P and HX16P where the stress is constant in the z direction.
3. All elements pass the [patch test](#).
4. When using table input format for temperature dependent ORTHOTROPIC SOLID or ANISOTROPIC SOLID material properties, the value of nset used is that defined in the first line of the property table.
5. Non-conservative loading is available with these elements when using Updated Lagrangian, Eulerian or co-rotational (with OPTION 36) geometric nonlinear formulations together with the FLD loading facility.
6. The global components of gravity acting on the fluid phase are defined by gx and gy under CBF and BF loading.

Restrictions

- ❑ Ensure mid-side node centrality
- ❑ Avoid excessive element curvature
- ❑ Avoid excessive aspect ratio

Recommendations on Use

- The 3D solid two phase elements should be used if the stress field is fully 3D, i.e. it cannot be approximated with any of the 2D elements, e.g. a non-axisymmetric pressure vessel.
- For linear materials, the 20-noded element with a $2 \times 2 \times 2$ Gauss rule is usually the most effective element, as this under-integration of the stiffness matrix prevents locking, i.e. over-stiff solutions will occur if the elements are used with a $3 \times 3 \times 3$ Gauss integration rule to model structures subjected to bending. However, the element possesses six [zero energy modes](#). Therefore, a careful examination of the solution should be performed to check for spurious stress oscillations and peculiarities in the deformed configuration. Either the 14-point or $3 \times 3 \times 3$ Gauss rules should be used for materially nonlinear problems or materially linear problems that exhibit spurious deformations.
- In general, PN15P and HX20P give the best performance; TH10P is less accurate and needs to be used with a finer mesh. HX16P and PN12P should only be used to overcome connectivity problems when meshing.

Chapter 5 : Plate Elements

2D Isoflex Thin Plate Flexure Elements

General

Element Name

TF3

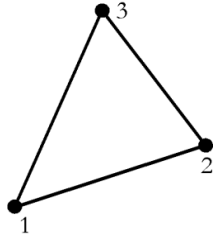
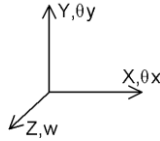

QF4

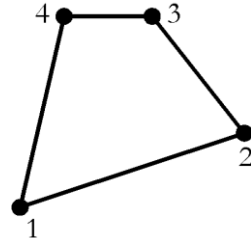

Element Group

Plates

Element

[Isoflex](#) Plates

Subgroup

Element Description

A family of thin plate flexure elements in 2D with higher order models capable of modelling curved boundaries. The element formulation takes account of varying thickness and anisotropic properties. As required by thin plate theory, transverse shearing effects are excluded.

Number Of Nodes

3 or 4 numbered anticlockwise.

Freedom

W, θ_x, θ_y : at the corner nodes.

Node

X, Y : at each node.

Coordinates

Geometric Properties

$t_1 \dots t_n$ Thickness at each node.

Material Properties

Linear

Isotropic:

MATERIAL PROPERTIES (Elastic: Isotropic)

Orthotropic:

MATERIAL PROPERTIES ORTHOTROPIC
(Elastic: Orthotropic Plane Stress)

Anisotropic:

MATERIAL PROPERTIES ANISOTROPIC 3
(Elastic: Anisotropic Thin Plate)

Rigidities.

RIGIDITIES 3 (Rigidities: Membrane/Thin Plate)

Matrix

Not applicable

Joint

Not applicable

Concrete	Not applicable
Elasto-Plastic	Not applicable
Creep	Not applicable
Damage	Not applicable
Viscoelastic	Not applicable
Shrinkage	Not applicable
Rubber	Not applicable
Generic Polymer	Not applicable
Composite	Not applicable

Loading

Prescribed Value	PDSP, TPDSP	Prescribed variable. W, θ_x , θ_y : at the corner nodes.
Concentrated Loads	CL	Concentrated loads. Pz, Mx, My: at corner nodes.
Element Loads	Not applicable.	
Distributed Loads	UDL	Uniformly distributed loads. Wz: normal pressure for element (global).
Body Forces	FLD, FLDG CBF BFP, BFPE	Not applicable. Constant body forces for element. Zcbf Body force potentials at nodes/for element. ϕ_1 , Zcbf
Velocities	VELO	Velocities. Vz: at nodes.
Accelerations	ACCE	Accelerations. Az: at nodes.
Viscous Support Loads	VSL	Viscous support loads. VLz at nodes.
Initial Stress/Strains	SSI, SSIE SSIG	Initial stresses/strains at nodes/for element. Mx, My, Mxy: moments/unit width (global). ψ_x , ψ_y , ψ_{xy} : flexural strains (global). Not applicable.
Residual Stresses	Not applicable.	
Target Stress/Strains	TSSIE, TSSIA TSSIG	Target stresses/strains at nodes/for element. Mx, My, Mxy: moments/unit width (global). ψ_x , ψ_y , ψ_{xy} : flexural strains (global). Not applicable.
Temperatures	TEMP, TMPE	Temperatures at nodes/for element. 0, 0, 0, dT/dz, 0, 0, 0, dTo/dz
Overburden	Not applicable.	

Phreatic Surface	Not applicable.
Field Loads	Not applicable.
Temp Dependent Loads	Not applicable.

LUSAS Output

Solver	Stress resultant: M_x , M_y , M_{xy} : moments/unit width (global). Strain: ψ_x , ψ_y , ψ_{xy} : flexural strains (global).
Modeller	See Results Tables (Appendix K) .

Local Axes

Not applicable (global axes are the reference).

Sign Convention

- [Standard plate element](#)

Formulation

Geometric Nonlinearity

Not applicable.

Integration Schemes

Stiffness	Default.	3-point (TF3), 2x2 (QF4).
	Fine.	As default.
Mass	Default.	3-point (TF3), 2x2 (QF4).
	Fine.	As default.

Mass Modelling

- Consistent mass (default).
- Lumped mass.

Options

- 18** Invokes fine integration rule for element.
- 55** Output strains as well as stresses.

- 143** Output shear forces for low order thin plate bending elements.
- 170** Suppress transfer of shape function arrays to disk.

Notes on Use

1. The element formulations are based on an [Kirchhoff](#) hypothesis for thin plates.
2. The variation of moments within the elements can be regarded as linear.
3. The elements pass the [patch test](#) for convergence for mixed triangular and quadrilateral element geometry.
4. The averaged nodal values produced with ELEMENT OUTPUT do not include the thin [isoflex](#) plate shear stresses if Option 143 is invoked.
5. When Option 143 is invoked shear stresses are only computed for the low order isoflex elements (QF4,TF3).

Restrictions

- [Avoid excessive aspect ratio](#)

Recommendations on Use

- This element may be used to analyse any 2D plate type structures where transverse shear effects do not influence the solution, e.g. thin cantilever plates.
- The thick plate elements QTF8 and TTF6 are recommended for thick plates where transverse shear strains are no longer negligible.

The following element combinations should be used for ribbed plates;

Ribs with small or no eccentricity

- QSI4/TS3 elements with BMI21 elements,
- QTS4/TTS3 elements with BMI21 elements.

Ribs with large eccentricity

- QSL8/TSL6 elements with BSL3/BSL4/BXL4 elements.
- QTS4/TTS3 elements with BMI21 elements.

The through thickness integration is performed explicitly.

2D Isoflex Thick Plate Flexure Element

General

Element Name

QSC4

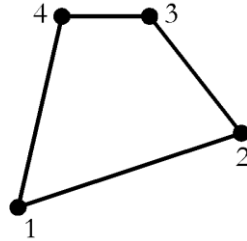
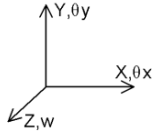

Element Group

Plates

Element Subgroup

[Isoflex](#) Plates

Element Description

A thick plate flexure element in 2D. The element formulation takes into account varying thickness and anisotropic properties. Transverse shearing effects are included.

Number Of Nodes

4, numbered anticlockwise.

Freedom

W, θ_x, θ_y : at each node.

Node Coordinates

X, Y : at each node.

Geometric Properties

$t_1 \dots t_n$ At each node.

Material Properties

Linear	Isotropic:	MATERIAL PROPERTIES (Elastic: Isotropic)
	Orthotropic:	MATERIAL PROPERTIES ORTHOTROPIC THICK (Elastic: Orthotropic Thick)
	Anisotropic:	MATERIAL PROPERTIES ANISOTROPIC 5 (Elastic: Anisotropic Thick Plate)
	Rigidities:	RIGIDITIES 5 (Rigidities: Thick Plate)
Matrix	Not applicable	
Joint	Not applicable	
Concrete	Not applicable	
Elasto-Plastic	Not applicable	
Creep	Not applicable	

	applicable.
Damage	Not applicable
Viscoelastic	Not applicable
Shrinkage	Not applicable
Rubber	Not applicable
Generic Polymer	Not applicable
Composite	Not applicable

Loading

Prescribed Value	PDSP, TPDSP	Prescribed variable. W, θ_x, θ_y : at nodes.
Concentrated Loads	CL	Concentrated loads. P_z, M_x, M_y : at nodes.
Element Loads	Not applicable.	
Distributed Loads	UDL	Uniformly distributed loads. W_z : normal pressure for element (global).
Body Forces	FLD, FLDG CBF BFP, BFPE	Not applicable. Constant body forces for element. Z_{cbf} Body force potentials at nodes/for element. ϕ_1, Z_{cbf}
Velocities	VELO	Velocities. V_z : at nodes.
Accelerations	ACCE	Accelerations. A_z : at nodes.
Viscous Support Loads	VSL	Viscous support loads. VL_z at nodes.
Initial Stress/Strains	SSI, SSIE SSIG	Initial stresses/strains at nodes/for element. M_x, M_y, M_{xy} : moments/unit width (global). $\psi_x, \psi_y, \psi_{xy}$: flexural strains (global).
Residual Stresses	Not applicable.	Not applicable.
Target Stress/Strains	TSSIE, TSSIA	Target stresses/strains at nodes/for element. M_x, M_y, M_{xy} : moments/unit width (global). $\psi_x, \psi_y, \psi_{xy}$: flexural strains (global).
Temperatures	TSSIG TEMP, TMPE	Not applicable. Temperatures at nodes/for element. $0, 0, 0, dT/dz, 0, 0, 0, dT_0/dz$
Overburden	Not applicable.	
Phreatic Surface	Not applicable.	

Field Loads Not applicable.
Temp Dependent Loads Not applicable.

LUSAS Output

Solver Stress resultant: $M_x, M_y, M_{xy}, S_x, S_y$: moments, shear forces/unit width (global)
Strain: $\psi_x, \psi_y, \psi_{xy}, \gamma_{xz}, \gamma_{yz}$: flexural, shear strains (global).
Modeller See [Results Tables \(Appendix K\)](#).

Local Axes

Not applicable (global axes are the reference).

Sign Convention

- Standard plate element

Formulation

Geometric Nonlinearity

Not applicable.

Integration Schemes

Stiffness	Default.	2x2
	Fine.	As default.
Mass	Default.	2x2
	Fine.	As default.

Mass Modelling

- Consistent mass (default).
- Lumped mass.

Options

- 55** Output strains as well as stresses.
- 105** Lumped mass matrix.
- 170** Suppress transfer of shape function arrays to disk.

Notes on Use

1. The element formulation involves imposing an assumed bi-linear shear strain field on the isoflex thin plate element QF4.
2. Though this element cannot model nonlinear behaviour, it can be mixed with other elements in a nonlinear analysis.
3. The element passes the [patch test](#) for convergence with rectangular and parallelogram element geometry.
4. The QF4, QF8, TF3, TF8 elements are usually more effective elements for thin plate analyses.
5. The QTF8 and TTF6 elements are usually more effective for thick plate analyses, and in such cases should be preferred to QSC4.
6. 3D solid elements should be used if the normal stress in the transverse direction is not insignificant in comparison with the in-plane stresses.
7. The following element combinations should be used for ribbed plates

Ribs with small or no eccentricity

- QSI4/TS3 elements with BMI21 elements,
- QTS4/TTS3 elements with BMI21 elements.

Ribs with large eccentricity

- QSL8/TSL6 elements with BSL3/BSL4/BXL4 elements,
- QTS4/TTS3 elements with BMI21 elements.

8. The through-thickness integration is performed explicitly.

Restrictions

- [Avoid excessive aspect ratio](#)

Recommendations on Use

This element may be used to analyse any 2D plate type structures where transverse shear effects influence the solution, e.g. perforated thick plates.

2D Mindlin Thick Plate Flexure Element

General

Element Name TTF6

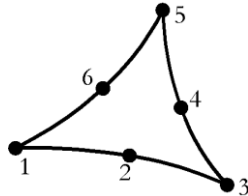
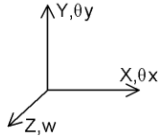

QTF8

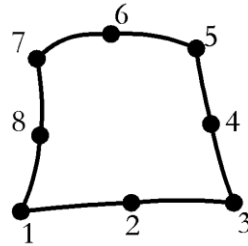

Element Group	Plates
Element Subgroup	Mindlin Plates
Element Description	A family of thick plate flexure elements based on a Mindlin plate formulation. The elements can accommodate curved boundaries and varying thicknesses. Transverse shear deformations are included.
Number Of Nodes	6 or 8, numbered anticlockwise.
Freedom	W, θ_x, θ_y : at each node.
Node Coordinates	X, Y : at each node.

Geometric Properties

$t_1 \dots t_n$ Thickness at each node.

Material Properties

Linear	Isotropic:	MATERIAL PROPERTIES (Elastic: Isotropic)
	Orthotropic:	MATERIAL PROPERTIES ORTHOTROPIC THICK (Elastic: Orthotropic Thick)
	Anisotropic:	MATERIAL PROPERTIES ANISOTROPIC 5 (Elastic: Anisotropic Thick Plate)
	Rigidities.	RIGIDITIES 5 (Rigidities: Thick Plate)
Matrix	Not applicable	
Joint	Not applicable	
Concrete	Not applicable	

Elasto-Plastic	Not applicable
Creep	Not applicable
Damage	Not applicable
Viscoelastic	Not applicable
Shrinkage	Not applicable
Rubber	Not applicable
Generic Polymer	Not applicable
Composite	Not applicable

Loading

Prescribed Value	PDSP, TPDSF	Prescribed variable. W, θ_x, θ_y : at nodes.
Concentrated Loads	CL	Concentrated loads. P_z, M_x, M_y : at nodes.
Element Loads	Not applicable.	
Distributed Loads	UDL	Uniformly distributed loads. W_z : normal pressure for element (global).
	FLD, FLDG	Not applicable.
Body Forces	CBF	Constant body forces for element. Z_{cbf}
	BFP, BFPE	Body force potentials at nodes/for element. ϕ_1, Z_{cbf}
Velocities	VELO	Velocities. V_z : at nodes.
Accelerations	ACCE	Accelerations. A_z : at nodes.
Viscous Support Loads	VSL	Viscous support loads. VL_z at nodes.
Initial Stress/Strains	SSI, SSIE	Initial stresses/strains at nodes/for element. $M_x, M_y, M_{xy}, S_x, S_y$: moments, shear forces/unit width (global). $\psi_x, \psi_y, \psi_{xy}, \gamma_{xz}, \gamma_{yz}$: flexural, shear strains /unit width (global).
	SSIG	Not applicable.
Residual Stresses	Not applicable.	
Target Stress/Strains	TSSIE, TSSIA	Target stresses/strains at nodes/for element. $M_x, M_y, M_{xy}, S_x, S_y$: moments, shear forces/unit width (global). $\psi_x, \psi_y, \psi_{xy}, \gamma_{xz}, \gamma_{yz}$: flexural, shear strains /unit width (global).
	TSSIG	Not applicable.
Temperatures	TEMP, TMPE	Temperatures at nodes/for element.

0, 0, 0, dT/dz, 0, 0, 0, dTo/dz

Overburden	Not applicable.
Phreatic Surface	Not applicable.
Field Loads	Not applicable.
Temp Dependent Loads	Not applicable.

Output

Solver	Stress resultant: M_x , M_y , M_{xy} , S_x , S_y : moments, shear forces/unit width (global). Strain: ψ_x , ψ_y , ψ_{xy} , γ_{xz} , γ_{yz} : flexural, shear strains /unit width (global).
Modeller	See Results Tables (Appendix K) .

Local Axes

Not applicable (global axes are the reference).

Sign Convention

- [Standard plate element](#)

Formulation

Geometric Nonlinearity

Not applicable.

Integration Schemes

Stiffness	Default.	3-point (TTF6), 2x2 (QTF8)
	Fine (see <i>Options</i>).	3x3 (QTF8).
Mass	Default.	3-point (TTF6), 2x2 (QTF8)
	Fine (see <i>Options</i>).	3x3 (QTF8).

Mass Modelling

- Consistent mass (default).
- Lumped mass.

Options

- 18 Invokes fine integration rule for element.
- 55 Output strains as well as stresses.
- 105 Lumped mass matrix.
- 170 Suppress transfer of shape function arrays to disk.

Notes on Use

1. The element formulations are based on an isoparametric approach. The variation of moments and shears within the element may be regarded as linear.
2. Though this element cannot model nonlinear behaviour, it can be mixed with other elements in a nonlinear analysis.
3. The elements pass the [patch test](#) for convergence with triangular and parallelogram element geometry.
4. These elements are usually more effective than the QSC4 thick shell element (section 7.6.2).
5. The elements tend to lock as the plate thickness approaches the thin plate limit since shear strain energy dominates the element stiffness. Therefore, a thin plate or shell element should be used when the depth/span ratio exceeds 1/50.
6. 3D solid elements should be used if the normal stress in the transverse direction is not insignificant in comparison with the in-plane stresses.
7. The following element combinations should be used for ribbed plates

Ribs with small or no eccentricity

- QSI4/TS3 elements with BMI21 elements,
- QTS4/TTS3 elements with BMI21 elements.

Ribs with large eccentricity

- QSL8/TSL6 elements with BSL3/BSL4/BXL4 elements,
- QTS4/TTS3 elements with BMI21 elements.

8. The QTF8 element with 2*2 Gauss quadrature is generally more effective than the 3*3 rule. The 2*2 rule does, however, exhibit one zero energy mode which can be eliminated using option 18.
9. The through-thickness integration is performed explicitly.

Restrictions

- Ensure mid-side node centrality
- Avoid excessive element curvature
- Avoid excessive aspect ratio

Recommendations on Use

These elements may be used to analyse any 2D plate type structures where transverse shear effects influence the solution, e.g. perforated thick plates.

Chapter 6: Shell Elements

2D Axisymmetric Thin Shell Element

General

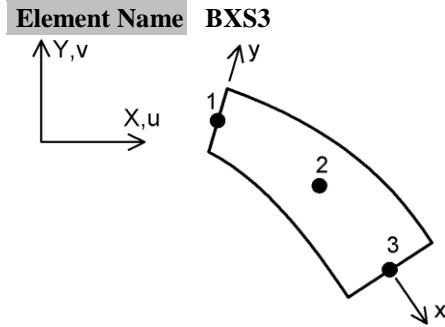

Element Group	Shells
Element Subgroup	Axisymmetric Shells
Element Description	A parabolically curved axisymmetric thin shell element in 2D in which shear deformations are excluded. The geometric properties may vary along the length of the element.
Number Of Nodes	3.
End Releases	
Freedoms	U, V, θ_z : at end nodes. dU: (relative local in-plane displacement) at the mid-length node.
Node Coordinates	X, Y: at each node.

Geometric Properties

t_1, t_2, t_3 Thickness at each node.

Material Properties

Linear	Isotropic:	MATERIAL PROPERTIES (Elastic: Isotropic)
	Orthotropic:	MATERIAL PROPERTIES ORTHOTROPIC (Elastic: Orthotropic Plane Stress) MATERIAL PROPERTIES ORTHOTROPIC SOLID (Elastic: Orthotropic Thick)
	Anisotropic:	MATERIAL PROPERTIES ANISOTROPIC 2 (Not supported in LUSAS Modeller)
	Rigidities:	Not applicable.

Matrix	Not applicable.	
Joint	Not applicable.	
Concrete	Not applicable.	
Elasto-Plastic	Stress resultant:	MATERIAL PROPERTIES NONLINEAR 29 (Elastic: Isotropic, Plastic: Resultant) (ifcode not required)
	Tresca:	MATERIAL PROPERTIES NONLINEAR 61 (Elastic: Isotropic, Plastic: Tresca, Hardening: Isotropic Hardening Gradient, Isotropic Plastic Strain or Isotropic Total Strain)
	Drucker-Prager:	MATERIAL PROPERTIES NONLINEAR 64 (Elastic: Isotropic, Plastic: Drucker-Prager, Hardening: Granular)
	Mohr-Coulomb:	MATERIAL PROPERTIES NONLINEAR 65 (Elastic: Isotropic, Plastic: Mohr-Coulomb, Hardening: Granular with Dilation)
	Optimised Implicit Von Mises:	MATERIAL PROPERTIES NONLINEAR 75 (Elastic: Isotropic, Plastic: Von Mises, Hardening: Isotropic & Kinematic)
	Volumetric Crushing:	Not applicable.
	Stress Potential	STRESS POTENTIAL VON_MISES, HILL, HOFFMAN (Isotropic: von Mises, Modified von Mises Orthotropic: Hill, Hoffman)
Creep		CREEP PROPERTIES (Creep)
	AASHTO	MATERIAL PROPERTIES NONLINEAR 86 AASHTO (Concrete creep model to AASHTO Code of Practice)
	CEB-FIP	MATERIAL PROPERTIES NONLINEAR 86 CEB-FIP (Concrete creep model to CEB-FIP Model Code 1990)
	Chinese	MATERIAL PROPERTIES NONLINEAR 86 CHINESE (Chinese creep model to Chinese Code of Practice)
	Eurocode	MATERIAL PROPERTIES NONLINEAR 86

		EUROCODE (Concrete creep model to EUROCODE_2)
	IRC	MATERIAL PROPERTIES NONLINEAR 86 IRC (Concrete creep model to Indian IRC Code of Practice)
Damage		DAMAGE PROPERTIES SIMO, OLIVER (Damage)
Viscoelastic	Not applicable.	
Shrinkage		SHRINKAGE CEB_FIP_90, EUROCODE_2, GENERAL, USER
Rubber	Not applicable.	
Generic Polymer	Not applicable	
Composite	Not applicable.	

Loading

Prescribed Value	PDSP, TPDSP	Prescribed variable. U, V, θ_z : at end nodes. dU: at the mid-length node.
Concentrated Loads	CL	Concentrated loads. Px, Py, Mx: point loads, moments/unit length/radian at end nodes (global). DPx: point load/unit length/radian at mid-length node (local).
Element Loads	ELDS	Element loads LTYPE, S1, Px, Py, Mx LTYPE=11: point loads and moments in local directions. LTYPE=12: point loads and moments in global directions. LTYPE, 0, Wx, Wy, Mx LTYPE=21: uniformly distributed loads in local directions. LTYPE=22: uniformly distributed loads in global directions. LTYPE=23: uniformly distributed projected loads in global directions LTYPE, S1, Wx1, Wy1, Mx1, S2, Wx2, Wy2, Mx2 LTYPE=31: distributed loads in local directions.

		LTYPE=32: distributed loads in global directions.
		LTYPE=33: distributed projected loads in global directions
		LTYPE, S1, W _x , W _y , M _x
		LTYPE=41: trapezoidal loads in local directions.
		LTYPE=42: trapezoidal loads in global directions.
		LTYPE=43: trapezoidal projected loads in global directions
Distributed Loads	UDL	Uniformly distributed loads. W _x , W _y : forces/unit length/radian in local x, y directions for element.
	FLD	Face Loads . P _x , P _y : local face pressures at nodes.
	FLDG	Not applicable.
Body Forces	CBF	Constant body forces for element. X _{cbf} , Y _{cbf} , Ω _x , Ω _y , Ω _z , α _z
	BFP, BFPE	Body force potentials at nodes/for element. φ ₁ , φ ₂ , 0, 0, X _{cbf} , Y _{cbf}
Velocities	VELO	Velocities. V _x , V _y : at nodes.
Accelerations	ACCE	Accelerations. A _x , A _y : at nodes.
Viscous Support Loads	VSL	Viscous support loads. VL _x , VL _y : at nodes.
Initial Stress/Strains	SSI, SSIE	Initial stresses/strains at nodes/for element. Resultants (for linear material models without cross section integration and material model 29). N _x , N _θ , M _x , M _θ , 0: axial and circumferential forces, moments/unit width. ε _x , ε _θ , ψ _x , ψ _θ , 0, axial and circumferential strains (all models).
	SSIG	Initial stresses/strains at Gauss points. (1) Resultants (for linear material models without cross section integration and material model 29). N _x , N _θ , M _x , M _θ , 0 : axial and circumferential forces, moments/unit width. ε _x , ε _θ , ψ _x , ψ _θ , 0: axial and circumferential strains (all models). (2) Components (for linear material models with cross section integration and all nonlinear material models except 29). 0, 0, 0,

		0, 0, 0, 0, 0, 0, 0, 0, ($\sigma_x, \sigma_\theta, \epsilon_x, \epsilon_\theta$) Bracketed terms repeated for each fibre integration point.
Residual Stresses	SSR, SSRE SSRG	Not applicable. Residual stresses at Gauss points. (1) Resultants (model 29). $N_x, N_\theta, M_x, M_\theta, 0$ (2) Components (all models except 29) 0, 0, 0, 0, 0, 0, 0, 0, 0, 0, (σ_x, σ_θ) Bracketed terms repeated for each fibre integration point.
Target Stress/Strains	TSSIE, TSSIA TSSIG	Target stresses/strains at nodes/for element. Resultants (for linear material models without cross section integration and material model 29). $N_x, N_\theta, M_x, M_\theta, 0$: axial and circumferential forces, moments/unit width. $\epsilon_x, \epsilon_\theta, \psi_x, \psi_\theta, 0$, axial and circumferential strains (all models). Target stresses/strains at Gauss points. (1) Resultants (for linear material models without cross section integration and material model 29). $N_x, N_\theta, M_x, M_\theta, 0$: axial and circumferential forces, moments/unit width. $\epsilon_x, \epsilon_\theta, \psi_x, \psi_\theta, 0$: axial and circumferential strains (all models). (2) Components (for linear material models with cross section integration and all nonlinear material models except 29). 0, 0, 0, 0, 0, 0, 0, 0, 0, 0, ($\sigma_x, \sigma_\theta, \epsilon_x, \epsilon_\theta$) Bracketed terms repeated for each fibre integration point.
Temperatures	TEMP, TMPE	Temperatures at nodes/for element. $T, 0, dT/dy, 0, T_0, 0, dT_0/dy, 0$: in local directions.
Overburden	Not applicable.	
Phreatic Surface	Applicable.	
Field Loads	Not applicable.	
Temp Dependent Loads	Not applicable.	

LUSAS Output

- Solver** Force. N_x , N_θ , M_x , M_θ : axial and circumferential forces, moments/unit width in local directions.
- Strain. ϵ_x , ϵ_θ , γ_x , γ_θ : axial and circumferential strains.
- Layer stress and strain output is also available when using the nonlinear continuum material models.
- Modeller** See [Results Tables \(Appendix K\)](#).

Local Axes

The local x-axis lies along the line of the element in the direction in which the nodes are numbered. The local y and z-axes form a right-hand set with the local x-axis such that the y-axis lies in the global XY-plane with the z-axis parallel to the global Z-axis.

Sign Convention

- Standard shell element. Axial and circumferential moments are positive for tension on element top fibre (the top fibre lies on the positive local y side of the element).

Formulation

Geometric Nonlinearity

- Total Lagrangian** For large displacements, rotations up to 1 radian, and small strains.
- Updated Lagrangian** For large displacements, rotation increments up to 1 radian and small strains.
- Eulerian** Not applicable.
- Co-rotational** Not applicable.

Integration Schemes

- | | | |
|------------------|-----------------------------|----------|
| Stiffness | Default. | 2-point. |
| | Fine (see <i>Options</i>). | 3-point. |
| Mass | Default. | 2-point. |
| | Fine (see <i>Options</i>). | 3-point. |

Mass Modelling

- Consistent mass (default).
- Lumped mass.

Options

- 18 Invokes fine integration rule for element
- 47 X-axis taken as axis of symmetry
- 54 Updated Lagrangian geometric nonlinearity.
- 55 Output strains as well as stresses.
- 87 Total Lagrangian geometric nonlinearity
- 105 Lumped mass matrix.
- 157 Material model 29 (non cross-section elements), see *Notes*.
- 170 Suppress transfer of shape function arrays to disk.

Notes on Use

1. The element formulation is based on a constrained super-parametric approach.
2. The variation of axial force and moment along the length of the element is linear. The variation of displacements is cubic in the local y-direction, and quadratic in the local x direction.
3. Temperature dependent properties cannot be used with material model 29.
4. The through-thickness integration is performed explicitly for linear and stress resultant plasticity models and with a 5-point [Newton-Cotes](#) rule for all other material models.

Restrictions

- [Ensure mid-side node centrality](#)
- Avoid excessive element curvature

Recommendations on Use

The element can be used for analysing shell structures which are axisymmetric, e.g. pressure vessels or pipes.

2D Axisymmetric Thick Shell Elements

General

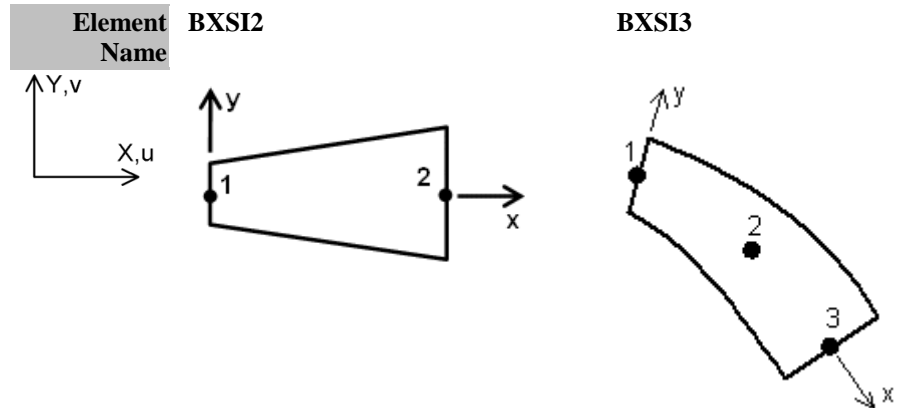

Element Group	Shells
Element Subgroup	Axisymmetric Shells
Element Description	Straight and curved isoparametric degenerate thick axisymmetric shell elements in 2D for which shearing deformations are included. The element thickness may vary along the length.
Number Of Nodes	2 (BXSI2), 3 (BXSI3)
End Releases	
Freedom	U, V, θ_z : at end nodes.
Node Coordinates	X, Y: at each node.

Geometric Properties

t_1, t_2, t_3 Thickness at each node.

Material Properties

Linear	Isotropic:	MATERIAL PROPERTIES (Elastic: Isotropic)
	Orthotropic:	MATERIAL PROPERTIES ORTHOTROPIC (Elastic: Orthotropic Plane Stress) MATERIAL PROPERTIES ORTHOTROPIC SOLID (Elastic: Orthotropic Thick)
	Anisotropic:	MATERIAL PROPERTIES ANISOTROPIC 2 (Not supported in LUSAS Modeller)

	Rigidities:	Not applicable.
Matrix	Not applicable.	
Joint	Not applicable.	
Concrete	Not applicable.	
Elasto-Plastic	Stress resultant: Tresca:	Not applicable. MATERIAL PROPERTIES NONLINEAR 61 (Elastic: Isotropic, Plastic: Tresca, Hardening: Isotropic Hardening Gradient, Isotropic Plastic Strain or Isotropic Total Strain)
	Drucker-Prager:	MATERIAL PROPERTIES NONLINEAR 64 (Elastic: Isotropic, Plastic: Drucker-Prager, Hardening: Granular)
	Mohr-Coulomb:	MATERIAL PROPERTIES NONLINEAR 65 (Elastic: Isotropic, Plastic: Mohr-Coulomb, Hardening: Granular with Dilation)
	Optimised Implicit Von Mises:	MATERIAL PROPERTIES NONLINEAR 75 (Elastic: Isotropic, Plastic: Von Mises, Hardening: Isotropic & Kinematic)
	Volumetric Crushing:	Not applicable.
	Stress Potential	STRESS POTENTIAL VON_MISES, HILL, HOFFMAN (Isotropic: von Mises, Modified von Mises Orthotropic: Hill, Hoffman)
Creep		CREEP PROPERTIES (Creep)
	AASHTO	MATERIAL PROPERTIES NONLINEAR 86 AASHTO (Concrete creep model to AASHTO code of Practice)
	CEB-FIP	MATERIAL PROPERTIES NONLINEAR 86 CEB-FIP (Concrete creep model to CEB-FIP Model Code 1990)
	Chinese	MATERIAL PROPERTIES NONLINEAR 86 CHINESE (Chinese creep model to Chinese Code of Practice)
	Eurocode	MATERIAL PROPERTIES NONLINEAR 86

		EUROCODE (Concrete creep model to EUROCODE_2)
	IRC	MATERIAL PROPERTIES NONLINEAR 86 IRC (Concrete creep model to Indian IRC code of Practice)
Damage		DAMAGE PROPERTIES SIMO, OLIVER (Damage)
Viscoelastic	Not applicable.	
Shrinkage		SHRINKAGE CEB_FIP_90, EUROCODE_2, GENERAL, USER
Rubber	Not applicable.	
Generic Polymer	Not applicable	
Composite	Not applicable.	

Loading

Prescribed Value	PDSP, TPDSP	Prescribed variable. U, V, θ_z : at end nodes.
Concentrated Loads	CL	Concentrated loads. Px, Py, Mx at nodes.
Element Loads	ELDS	Element loads on nodal line LTYPE, S1, Px, Py, Mz LTYPE=11: point loads and moments in local directions. LTYPE=12: point loads and moments in global directions. LTYPE, 0, Wx, Wy, Mz LTYPE=21: uniformly distributed loads in local directions. LTYPE=22: uniformly distributed loads in global directions. LTYPE=23: uniformly distributed projected loads in global directions LTYPE, S1, Wx1, Wy1, Mz1, S2, Wx2, Wy2, Mz2 LTYPE=31: distributed loads in local directions. LTYPE=32: distributed loads in global directions. LTYPE=33: distributed projected loads in

		global directions LTYPE, S1, W _x , W _y , M _z LTYPE=41: trapezoidal loads in local directions. LTYPE=42: trapezoidal loads in global directions. LTYPE=43: trapezoidal projected loads in global directions
Distributed Loads	UDL	Uniformly distributed loads. W _x , W _y : forces/unit length/radian in local x, y directions for element.
	FLD	Face Loads . P _x , P _y : local face pressures at nodes.
	FLDG	Not applicable.
Body Forces	CBF	Constant body forces for element. X _{cbf} , Y _{cbf} , Ω _x , Ω _y , Ω _z , α _z
	BFP, BFPE	Body force potentials at nodes/for element. φ ₁ , φ ₂ , 0, 0, X _{cbf} , Y _{cbf}
Velocities	VELO	Velocities. V _x , V _y : at nodes.
Accelerations	ACCE	Accelerations. A _x , A _y : at nodes.
Viscous Support Loads	VSL	Viscous support loads. VL _x , VL _y : at nodes.
Initial Stress/Strains	SSI, SSIE	Initial stresses/strains at nodes/for element. Components: 0, 0, 0, 0, 0, 0, 0, 0, 0, 0, (σ _x , σ _{xy} , σ _z , ε _x , ε _{xy} , ε _z) Bracketed terms repeated for each fibre integration point
	SSIG	Initial stresses/strains at Gauss points. These stresses/strains are specified in the same manner as SSI and SSIE.
Residual Stresses	SSR, SSRE	Residual stresses at nodes/for element. Components: 0, 0, 0, 0, 0, 0, 0, 0, 0, 0, (σ _x , σ _{xy} , σ _z) Bracketed terms repeated for each fibre integration point.
	SSRG	Residual stresses at Gauss points for element. Components: 0, 0, 0, 0, 0, 0, 0, 0, 0, 0, (σ _x , σ _{xy} , σ _z) Bracketed terms repeated for each fibre integration point.
Target Stress/Strains	TSSIE, TSSIA	Target stresses/strains at nodes/for element. Components: 0, 0, 0, 0, 0, 0, 0, 0, 0, 0, (σ _x , σ _{xy} , σ _z) Bracketed terms repeated for each fibre integration point.

	TSSIG	Target stresses/strains at Gauss points. These stresses/strains are specified in the same manner as TSSIE and TSSIA.
Temperatures	TEMP, TMPE	Temperatures at nodes/for element. T, 0, dT/dy, 0, To, 0, dTo/dy, 0: in local directions.
Overburden	Not applicable.	
Phreatic Surface	Face pressure.	The fluid pressure is applied in the -y direction of the element y axis.
Field Loads	Not applicable.	
Temp Dependent Loads	Not applicable.	

LUSAS Output

Solver	Force. Nx, Ne, Mx, Me, Sxy: axial and hoop forces, moments/unit width in local directions, shear force Strain. ϵ_x , ϵ_\square , γ_x , $\square\theta$, ϵ_{xy} axial, hoop, flexural and shear strains. Continuum stresses: σ_x , σ_{xy} , σ_θ in local directions. Strain: ϵ_x , ϵ_{xy} , ϵ_\square : Axial, shear and hoop strains in local directions.
Modeller	See Results Tables (Appendix K) .

Local Axes

The local x-axis lies along the line of the element in the direction in which the nodes are numbered. The local y and z-axes form a right-hand set with the local x-axis such that the y-axis lies in the global XY-plane with the z-axis parallel to the global Z-axis.

Sign Convention

- Standard shell element. Axial and circumferential moments are positive for tension on element top fibre (the top fibre lies on the positive local y side of the element).

Formulation

Geometric Nonlinearity

Total Lagrangian For large displacements, rotations up to 1 radian, and small strains.

Updated Lagrangian	Not applicable.
Eulerian	Not applicable.
Co-rotational	Not applicable.

Integration Schemes

Stiffness	Default.	1-point (BXS12), 2-point (BXS13).
	Fine (see <i>Options</i>).	Same as default.
Mass	Default.	2-point (BXS12), 3-point (BXS13).
	Fine (see <i>Options</i>).	Same as default.

Mass Modelling

- Consistent mass (default).
- Lumped mass.

Options

- 18** Invokes fine integration rule for element
- 55** Output strains as well as stresses.
- 87** Total Lagrangian geometric nonlinearity
- 102** Switch off load correction stiffness matrix due to centripetal acceleration
- 105** Lumped mass matrix.
- 134** Gauss to Newton-Cotes in plane (in the local x direction) integration for elements.
- 139** Output yielded integration points only.

Notes on Use

1. The element is formulated from the degenerate continuum concept, i.e. enforcing directly the modified Timoshenko hypothesis for thick beams to the continuum theory. Plane cross-sections initially normal to the x axis remain plane and undistorted (the shape of the cross-section remains unchanged) under deformation, but do not necessarily remain normal to the x axis. Shearing deformations are included.
2. The axial force, hoop force, shear force and moments are constant in BXS12 and vary linearly along the length of the beam in BXS13.
3. OPTION 36 is only applicable for use with element load types FLD, ELDS, UDL and phreatic surface pressure. Specifying this option makes these element loads follow the element geometry as the analysis progresses.

Restrictions

- Ensure mid-side node centrality
- Avoid excessive element curvature

Recommendations on Use

The element can be used for analysing linear and nonlinear shell structures which are axisymmetric, e.g. pressure vessels or pipes.

3D Flat Thin Shell Elements

General

Element Name TS3

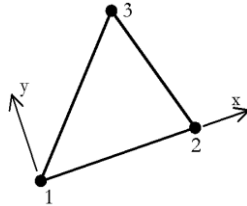
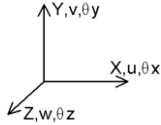

Element Name QSI4

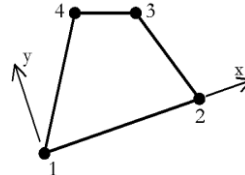

Element Group	Shells
Element Subgroup	Flat Thin Shells
Element Description	A family of flat thin shells in 3D which include a high performance incompatible model. The elements take into account both membrane and flexural deformations. As required by thin plate theory, transverse shearing deformations are excluded. An average thickness value for each element is obtained from the specified nodal thicknesses. Since the elements are formulated in local element axes, directional material properties may be defined relative to the element orientation.
Number Of Nodes	3 or 4 numbered anticlockwise.
Freedom	U, V, W, θ_x , θ_y , θ_z : at each node.
Node Coordinates	X, Y, Z: at each node.

Geometric Properties

Ez, t1... tn [Eccentricity](#) and thickness at each node.

Material Properties

Linear	Isotropic:	MATERIAL PROPERTIES (Elastic: Isotropic)
	Orthotropic:	MATERIAL PROPERTIES ORTHOTROPIC (Elastic: Orthotropic Plane Stress)
		MATERIAL PROPERTIES ORTHOTROPIC SOLID (Elastic: Orthotropic Thick)
	Anisotropic:	MATERIAL PROPERTIES

		ANISOTROPIC 3 (Elastic: Anisotropic Thin Plate)
	Rigidities.	RIGIDITIES 6 (Rigidities: Shell) (D7, D8, D9, D11, D12, D13, D16, D17, D18=0)
Matrix	Not applicable	
Joint	Not applicable	
Concrete	Not applicable	
Elasto-Plastic	Not applicable	
Creep	Not applicable	
Damage	Not applicable	
Viscoelastic	Not applicable	
Shrinkage		SHRINKAGE CEB_FIP_90, EUROCODE_2, GENERAL, USER
Rubber	Not applicable	
Generic Polymer	Not applicable	
Composite	Not applicable	

Loading

Prescribed Value	PDSP, TPDSP	Prescribed variable. U, V, W, θ_x , θ_y , θ_z : at nodes.
Concentrated Loads	CL	Concentrated loads. Px, Py, Pz, Mx, My, Mz: at nodes.
Element Loads	Not applicable.	
Distributed Loads	UDL	Uniformly distributed loads. Wx, Wy, Wz: local surface pressures for element (see Notes).
	FLD, FLDG	Not applicable.
Body Forces	CBF	Constant body forces for element. Xcbf, Ycbf, Zcbf (see Notes).
	BFP, BFPE	Body force potentials at nodes/for element. ϕ_1 , ϕ_2 , ϕ_3 (see Notes).
Velocities	VELO	Velocities. Vx, Vy, Vz: at nodes.
Accelerations	ACCE	Accelerations. Ax, Ay, Az: at nodes.
Viscous Support Loads	VSL	Viscous support loads. VLx, VLy, VLz: at nodes.
Initial Stress/Strains	SSI, SSIE	Initial stresses/strains at nodes/for element. Resultants. Nx, Ny, Nxy, Mx, My, Mxy: forces, moments/unit width in local

		directions. ϵ_x , ϵ_y , γ_{xy} , ψ_x , ψ_y , ψ_{xy} : membrane, flexural strains in local directions (see Notes).
	SSIG	Not applicable.
Residual Stresses	Not applicable.	
	Target Stress/Strains	TSSIE, TSSIA
		Target stresses/strains at nodes/for element. Resultants. N_x , N_y , N_{xy} , M_x , M_y , M_{xy} : forces, moments/unit width in local directions. ϵ_x , ϵ_y , γ_{xy} , ψ_x , ψ_y , ψ_{xy} : membrane, flexural strains in local directions (see Notes).
	TSSIG	Not applicable.
Temperatures	TEMP, TMPE	Temperatures at nodes/for element. T , 0 , 0 , dT/dz , T_0 , 0 , 0 , dT_0/dz : in local directions. (see Notes)
Overburden	Not applicable.	
Phreatic Surface	Not applicable.	
Field Loads	Not applicable.	
Temp Dependent Loads	Not applicable.	

LUSAS Output

Solver	Stress resultant: N_x , N_y , N_{xy} , M_x , M_y , M_{xy} : forces, moments/unit width in local directions. Stress (default): σ_x , σ_y , σ_{xy} , σ_{max} , σ_{min} , β , σ_e : in local directions (see <i>Notes</i>). Strain: ϵ_x , ϵ_y , γ_{xy} , ψ_x , ψ_y , ψ_{xy} : membrane, flexural strains in local directions.
Modeller	See Results Tables (Appendix K) .

Local Axes

- [Standard area element](#)

Sign Convention

- [Thin shell element](#)

Formulation

Geometric Nonlinearity

Not applicable.

Integration Schemes

Stiffness	Default.	1-point for the in-plane incompatible modes, (QSI4), 2x2 for the in-plane compatible modes, (QSI4), 2x2 for bending (QSI4). 1-point for in-plane (TS3), 3-point for bending (TS3).
	Fine.	As default.
Mass	Default.	1-point for the in-plane incompatible modes, (QSI4), 2x2 for the in-plane compatible modes, (QSI4), 2x2 for bending (QSI4). 1-point for in-plane (TS3), 3-point for bending (TS3).
	Fine.	As default.

Mass Modelling

Lumped mass only.

Options

- 32 Suppress stress output but not stress resultants.
- 34 Outputs stress resultants.
- 55 Outputs strains as well as stresses.
- 59 Outputs local direction cosines for elements.
- 170 Suppresses transfer of shape function arrays to disk.

Notes on Use

1. The element formulations are based on the standard [isoflex](#) approach for the flexural matrices.
2. The variation of membrane stresses within the element can be regarded as constant for TS3 and linear for QSI4. The higher order membrane performance of QSI4 is due to the addition of four incompatible in-plane displacement modes. The variation of flexural stresses can be regarded as linear for all elements.

3. The stress results are most easily interpreted if the local element axes are all parallel.
4. The elements pass the [patch test](#) for mixed triangular and quadrilateral geometry.
5. Stress output to the LUSAS output file is on 4 lines:
 - Stresses due to membrane action.
 - Top surface stresses due to bending action.
 - Top surface stresses due to membrane and bending action.
 - Bottom surface stresses due to membrane and bending action.

Gauss point output is not available.

6. All distributed loading will be lumped at the nodes.
7. For effective analysis of curved shell structures, a flat shell element should not extend over more than 15 degrees of arc.
8. Though this element cannot model nonlinear behaviour, it can be mixed with other elements in a nonlinear analysis.
9. A system variable is used to alter the artificial stiffness for in-plane rotations.
10. A fine discretisation will be required to reproduce the correct behavioural response for curved structures. Therefore, the Semiloof shell elements (QSL8,TSL6) or the thick shell elements (QTS8, TTS6) may be more appropriate.
11. The ORTHOTROIC SOLID material model may be used with either composite or non-composite thin shell elements. Using a Solid rather than a Thick orthotropic material means that a local coordinate may be used to orientate the material.
12. Element loading on elements with eccentricity is applied as follows:
 - SSI, SSIE, TSSIE, TSSIA, TEMP, TMPE – at the mid-plane of the element.
 - UDL, CBF, BFP, BFPE – at the nodal plane.

Restrictions

- [Avoid excessive aspect ratio.](#)
- [Avoid excessive warping.](#)

Recommendations on Use

- The flat thin shell elements are suitable for modelling both flat and curved thin shell structures which exhibit negligible transverse shear deformations.
- A fine discretisation will be required to reproduce the correct behavioural response for curved structures. Therefore, the Semiloof shell elements (QSL8,TSL6) or the thick shell elements (QTS8, TTS6) may be more appropriate.
- The Semiloof shell elements (QSL8,TSL6) or the thick shell elements (QTS8, TTS6) are more effective for structures containing multiple shell intersections.
- The Semiloof shell elements (QSL8,TSL6) or the thick shell elements (QTS4, QTS8, TTS3, TTS6) may be more effective for eigen-analyses since a consistent mass matrix is available.
- The Semiloof shell elements (QSL8,TSL6) should be utilised for nonlinear analyses.
- The elements can be combined with BMI21 beam elements for analysing ribbed shells with small or no eccentricity. However, the Semiloof shell (QSL8,TSL6) and beam (BSL3,BSL4,BXL4) are more effective for thin ribbed shells with larger eccentricity. For thick ribbed shells with larger eccentricity the thick shell (QTS4, QTS8, TTS3, TTS6) and co-rotational beam (BMI21) are recommended.

3D Flat Thin Nonlinear Shell Element

General

Element Name

TSR6

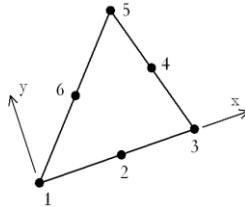
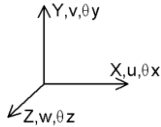

Element Group

Shells

Element

Flat Thin Shells

Subgroup

Element Description

A triangular shell element for the analysis of faceted shell geometries, including multiple branched junctions. The elements can accommodate varying thickness and anisotropic material properties. The element is based on the “Morley shell” formulation and assumes constant membrane and bending strains across the element. As required by thin shell theory, transverse shearing deformations are excluded.

Number Of Nodes

6 numbered anticlockwise.

Freedom

U, V, W: at corner nodes. θ_1 : (loof rotation) at mid-side nodes (see *Notes*).

Node Coordinates

X, Y, Z: at each node.

Geometric Properties

$t_1 \dots t_n$ Thickness at each node.

Material Properties

Linear	Isotropic:	MATERIAL PROPERTIES (Elastic: Isotropic)
	Orthotropic:	MATERIAL PROPERTIES ORTHOTROPIC (Elastic: Orthotropic Plane Stress) MATERIAL PROPERTIES ORTHOTROPIC SOLID (Elastic: Orthotropic Thick)
	Anisotropic:	MATERIAL PROPERTIES ANISOTROPIC 3 (Elastic: Anisotropic Thin Plate)

	Rigidities.	RIGIDITIES 6 (Rigidities: Shell)
Matrix	Not applicable	
Joint	Not applicable	
Concrete		MATERIAL PROPERTIES NONLINEAR 109 (Elastic: Isotropic, Plastic: Smoothed Multi-Crack Concrete)
Elasto-Plastic	Stress resultant:	MATERIAL PROPERTIES NONLINEAR 29 (Elastic: Isotropic, Plastic: Resultant) (ifcode not required)
	Tresca:	MATERIAL PROPERTIES NONLINEAR 61 (Elastic: Isotropic, Plastic: Tresca, Hardening: Isotropic Hardening Gradient, Isotropic Plastic Strain or Isotropic Total Strain)
	Drucker-Prager:	MATERIAL PROPERTIES NONLINEAR 64 (Elastic: Isotropic, Plastic: Drucker-Prager, Hardening: Granular)
	Mohr-Coulomb:	MATERIAL PROPERTIES NONLINEAR 65 (Elastic: Isotropic, Plastic: Mohr-Coulomb, Hardening: Granular with Dilation)
	Volumetric Crushing:	Not applicable.
	Stress Potential	STRESS POTENTIAL VON_MISES, HILL, HOFFMAN (Isotropic: von Mises, Modified von Mises Orthotropic: Hill, Hoffman)
Creep		CREEP PROPERTIES (Creep)
	AASHTO	Not applicable
	CEB-FIP	Not applicable

	Chinese	Not applicable
	Eurocode	Not applicable
	IRC	Not applicable
Damage		DAMAGE PROPERTIES SIMO, OLIVER (Damage)
Viscoelastic	Not applicable	
Shrinkage		GENERAL, USER
Rubber	Not applicable.	
Generic Polymer	Not applicable	
Composite	Not applicable	
 Loading		
Prescribed Value	PDSP, TPDSP	Prescribed variable. U, V, W: at corner nodes. θ_1 : at mid-side nodes.
Concentrated Loads	CL	Concentrated loads. Px, Py, Pz: at corner nodes. M1: at mid-side nodes.
Element Loads	Not applicable.	
Distributed Loads	UDL	Uniformly distributed loads. Wx, Wy, Wz: mid-surface local pressures for element.
	FLD, FLDG	Not applicable.
Body Forces	CBF	Constant body forces for element. Xcbf, Ycbf, Zcbf, Ω_x , Ω_y , Ω_z , α_x , α_y , α_z
	BFP, BFPE	Body force potentials at nodes/for element. φ_1 , φ_2 , φ_3 , 0, Xcbf, Ycbf, Zcbf, where φ_1 , φ_2 , φ_3 are the face loads in the local coordinate

Velocities	VELO	system. Velocities. V_x, V_y, V_z : at corner nodes.
Accelerations	ACCE	Accelerations. A_x, A_y, A_z : at corner nodes.
Viscous Support Loads	VSL	Viscous support loads. VL_x, VL_y, VL_z : at nodes.
Initial Stress/Strains	SSI, SSIE SSIG	Initial stresses/strains at nodes/for element. Initial stresses/strains at Gauss points. (1) Resultants (for model 29 and RIGIDITIES) $N_x, N_y, N_{xy}, M_x, M_y, M_{xy}, \epsilon_x, \epsilon_y, \gamma_{xy}, \psi_x, \psi_y, \psi_{xy}$: forces, moments/unit width and membrane/flexural strains in local directions. (2) Components (in all other cases except for nonlinear model 29 and RIGIDITIES), 0, $(\sigma_x, \sigma_y, \sigma_{xy}, \epsilon_x, \epsilon_y, \gamma_{xy})$. Bracketed terms repeat for each layer.
Residual Stresses	SSR, SSRE SSRG	Residual stresses at nodes/for element Residual stresses at Gauss points. (1) Resultants (for model 29) $N_x, N_y, N_{xy}, M_x, M_y, M_{xy}$: forces, moments/unit width in local directions. (2) Components (for all nonlinear material models except model 29): 0, $(\sigma_x, \sigma_y, \sigma_{xy})$. Bracketed terms repeat for each layer.
Target Stress/Strains	TSSIE, TSSIA TSSIG	Target stresses/strains at nodes/for element. Target stresses/strains at Gauss points. (1) Resultants (for model 29 and RIGIDITIES) $N_x, N_y, N_{xy}, M_x, M_y, M_{xy}, \epsilon_x, \epsilon_y, \gamma_{xy}, \psi_x, \psi_y, \psi_{xy}$: forces, moments/unit width and membrane/flexural strains in local directions. (2) Components (in all other cases except for nonlinear model 29 and RIGIDITIES), 0, $(\sigma_x, \sigma_y, \sigma_{xy}, \epsilon_x, \epsilon_y, \gamma_{xy})$. Bracketed terms repeat for each layer.
Temperatures	TEMP, TMPE	Temperatures at nodes/for element. $T, 0, 0, dT/dz, T_0, 0, 0, dT_0/dz$
Overburden	Not applicable.	

Phreatic Surface	Not applicable.
Field Loads	Not applicable.
Temp Dependent Loads	Not applicable.

LUSAS Output

Solver	Stress resultant: N_x , N_y , N_{xy} , M_x , M_y , M_{xy} : forces, moments/unit width in local directions. Stress (default): σ_x , σ_y , σ_{xy} , σ_{max} , σ_{min} , β , σ_e : in local directions (see <i>Notes</i>). Strain: ϵ_x , ϵ_y , γ_{xy} , ψ_x , ψ_y , ψ_{xy} : membrane, flexural strains in local directions.
Modeller	See Results Tables (Appendix K) .

Local Axes

- [Standard area element](#)

Sign Convention

- [Thin shell element](#)

Formulation

Geometric Nonlinearity

Total Lagrangian	Not applicable.
Updated Lagrangian	Not applicable.
Eulerian	Not applicable.
Co-rotational	For large displacements and rotations

Integration Schemes

Stiffness Default.	1-point
Fine.	1-point
Coarse.	1-point
Mass Default.	1-point

Fine.

1-point

Mass Modelling

- Consistent mass.

Options

- 32 Suppresses stress output but not resultants.
- 34 Outputs element stress resultants.
- 55 Outputs strains as well as stresses.
- 59 Outputs local direction cosines at nodes and Gauss points.
- 77 Output principal stresses and directions.
- 139 Output yielded Gauss points only.

Notes on Use

1. The element formulations are based on a [Kirchhoff](#) hypothesis for thin shells.
2. The stresses are constant within the elements.
3. The loof rotations refer to rotations about the element edge at the mid-side nodes. The positive direction of a loof rotation is defined by a right-hand screw rule applied to a vector running in the direction of the lower to higher numbered corner nodes. It should be noted that this direction is enforced on a global level which means that the loof rotations along the adjoining edge of several elements will be consistent in terms of direction and ordering.
4. The element edges must remain straight even though the elements have mid-side nodes.
5. The elements pass the [patch test](#) for convergence.
6. Stresse will not be output when using RIGIDITIES or material model 29.
7. The through-thickness integration is performed explicitly for linear analyses and a 5-point [Newton-Cotes](#) rule is utilised for materially nonlinear analyses with continuum material models. The through-thickness integration rules are as follows:
 - Linear models: 3-layers.
 - Nonlinear models: 5-layers.

Restrictions

- [Ensure mid-side node centrality and straight element edges](#)
- Avoid excessive aspect ratio

Recommendations on Use

- These elements may be utilised for analysing flat and faceted 3D shell structures where the transverse shear effects do not influence the solution. The configuration of the nodal freedoms provides an element suitable for modelling intersecting shells.
- The elements are recommended for geometrically nonlinear problems where large displacements and rotations occur. The single Gauss point integration scheme gives rise to a computationally efficient solution, however, the mesh may need to be refined if there is an unacceptable differentiation in stresses between adjacent elements..

Semiloof Curved Thin Shell Elements

General

Element Name

TSL6

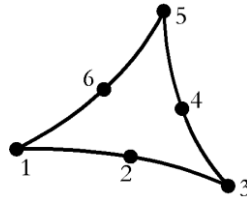
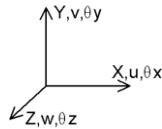

QSL8

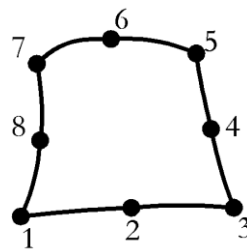

Element Group

Shells

Element Subgroup

Semiloof Shells

Element Description

A family of shell elements for the analysis of arbitrarily curved shell geometries, including multiple branched junctions. The elements can accommodate generally curved geometry with varying thickness and anisotropic and composite material properties. The element formulation takes account of both membrane and flexural deformations. As required by thin shell theory, transverse shearing deformations are excluded.

Number Of Nodes

6 or 8 numbered anticlockwise.

Freedom

U, V, W: at corner nodes. U, V, W, θ_1 , θ_2 : (loof rotations) at mid-side nodes (see *Notes*).

Node Coordinates

X, Y, Z: at each node.

Geometric Properties

$t_1 \dots t_n$ Thickness at each node. Also see *Composite Geometry* data chapter.

Material Properties

Linear	Isotropic:	MATERIAL PROPERTIES (Elastic: Isotropic)
	Orthotropic:	MATERIAL PROPERTIES ORTHOTROPIC (Elastic: Orthotropic Plane Stress)
		MATERIAL PROPERTIES ORTHOTROPIC SOLID (Elastic: Orthotropic Solid)

	Anisotropic:	MATERIAL PROPERTIES ANISOTROPIC 3 (Elastic: Anisotropic Thin Plate)
	Rigidities.	RIGIDITIES 6 (Rigidities: Shell)
Matrix	Not applicable	
Joint	Not applicable	
Concrete	MATERIAL PROPERTIES NONLINEAR 109 (Elastic: Isotropic, Plastic: Smoothed Multi-Crack Concrete)	
Elasto-Plastic	Stress resultant:	MATERIAL PROPERTIES NONLINEAR 29 (Elastic: Isotropic, Plastic: Resultant) (ifcode not required)
	Tresca:	MATERIAL PROPERTIES NONLINEAR 61 (Elastic: Isotropic, Plastic: Tresca, Hardening: Isotropic Hardening Gradient, Isotropic Plastic Strain or Isotropic Total Strain)
	Drucker-Prager:	MATERIAL PROPERTIES NONLINEAR 64 (Elastic: Isotropic, Plastic: Drucker-Prager, Hardening: Granular)
	Mohr-Coulomb:	MATERIAL PROPERTIES NONLINEAR 65 (Elastic: Isotropic, Plastic: Mohr-Coulomb, Hardening: Granular with Dilation)
	Volumetric Crushing:	Not applicable.
	Stress Potential	STRESS POTENTIAL VON_MISES, HILL, HOFFMAN (Isotropic: von Mises, Modified von Mises Orthotropic: Hill, Hoffman)
Creep	CREEP PROPERTIES (Creep)	
	AASHTO	MATERIAL PROPERTIES NONLINEAR 86 AASHTO (Concrete creep model to AASHTO code of Practice)

	CEB-FIP	MATERIAL PROPERTIES NONLINEAR 86 CEB-FIP (Concrete creep model to CEB-FIP Model Code 1990)
	Chinese	MATERIAL PROPERTIES NONLINEAR 86 CHINESE (Chinese creep model to Chinese Code of Practice)
	Eurocode	MATERIAL PROPERTIES NONLINEAR 86 EUROCODE (Concrete creep model to EUROCODE_2)
	IRC	MATERIAL PROPERTIES NONLINEAR 86 IRC (Concrete creep model to Indian IRC code of Practice)
	Damage	DAMAGE PROPERTIES SIMO, OLIVER (Damage)
	Viscoelastic	Not applicable
	Shrinkage	SHRINKAGE CEB_FIP_90, EUROCODE_2, GENERAL, USER
	Rubber	Not applicable.
	Generic Polymer	Not applicable
	Composite	Composite shell: COMPOSITE PROPERTIES
Loading		
	Prescribed Value	PDSP, TPDSP Prescribed variable. U, V, W: at corner nodes. U, V, W, θ_1 , θ_2 : at mid-side nodes.
	Concentrated Loads	CL Concentrated loads. Px, Py, Pz: at corner nodes. Px, Py, Pz, M1, M2: at mid-side nodes.
	Element Loads	Not applicable.
	Distributed Loads	UDL Uniformly distributed loads. Wx, Wy, Wz: mid-

		surface local pressures for element.
	FLD, FLDG	Not applicable.
Body Forces	CBF	Constant body forces for element. X_{cbf} , Y_{cbf} , Z_{cbf} , Ω_x , Ω_y , Ω_z , α_x , α_y , α_z
	BFP, BFPE	Body force potentials at nodes/for element. ϕ_1 , ϕ_2 , ϕ_3 , 0, X_{cbf} , Y_{cbf} , Z_{cbf} , where ϕ_1 , ϕ_2 , ϕ_3 are the face loads in the local coordinate system.
Velocities	VELO	Velocities. V_x , V_y , V_z : at nodes.
Accelerations	ACCE	Accelerations. A_x , A_y , A_z : at nodes.
Viscous Support Loads	VSL	Viscous support loads. VL_x , VL_y , VL_z : at nodes.
Initial Stress/Strains	SSI, SSIE	Not applicable.
	SSIG	Initial stresses/strains at Gauss points. (1) Resultants (for linear analysis and model 29) N_x , N_y , N_{xy} , M_x , M_y , M_{xy} , ϵ_x , ϵ_y , γ_{xy} , ψ_x , ψ_y , ψ_{xy} : forces, moments/unit width and membrane/flexural strains in local directions. (2) Components (for all other nonlinear material models) are: 0, 0, 0, 0, 0, 0, 0, 0, 0, 0, 0, 0, $(\sigma_x, \sigma_y, \sigma_{xy}, \epsilon_x, \epsilon_y, \gamma_{xy})$ - with the bracketed terms repeated for each of the five layers. (See note 7 in the Notes of Use) section.
Residual Stresses	SSR, SSRE	Not applicable.
	SSRG	Residual stresses at Gauss points. (1) Resultants (for model 29) N_x , N_y , N_{xy} , M_x , M_y , M_{xy} : forces, moments/unit width in local directions. (2) Components (for all other nonlinear material models) are: 0, 0, 0, 0, 0, 0, 0, 0, 0, 0, 0, 0, $(\sigma_x, \sigma_y, \sigma_{xy})$ - with the bracketed terms repeated for each of the five layers. (See note 7 in the Notes of Use) section.
Target Stress/Strains	TSSIE, TSSIA	Not applicable.
	TSSIG	Target stresses/strains at Gauss points. (1) Resultants (for linear analysis and model 29) N_x , N_y , N_{xy} , M_x , M_y , M_{xy} , ϵ_x , ϵ_y , γ_{xy} , ψ_x , ψ_y , ψ_{xy} : forces, moments/unit width and

membrane/flexural strains in local directions.
 (2) Components (for all other nonlinear material models) are: 0, 0, 0, 0, 0, 0, 0, 0, 0, 0, 0, 0, 0, 0, $(\sigma_x, \sigma_y, \sigma_{xy}, \varepsilon_x, \varepsilon_y, \gamma_{xy})$ - with the bracketed terms repeated for each of the five layers. (See note 7 in the Notes of Use) section.

Temperatures	TEMP, TMPE	Temperatures at nodes/for element. T, 0, 0, dT/dz, To, 0, 0, dTo/dz
Overburden	Not applicable.	
Phreatic Surface	Not applicable.	
Field Loads	Not applicable.	
Temp Dependent Loads	Not applicable.	

LUSAS Output

Solver Stress resultant: $N_x, N_y, N_{xy}, M_x, M_y, M_{xy}$: forces, moments/unit width in local directions.
 Stress (default): $\sigma_x, \sigma_y, \sigma_{xy}, \sigma_{max}, \sigma_{min}, \beta, \sigma_e$: in local directions (see *Notes*).
 Strain: $\varepsilon_x, \varepsilon_y, \gamma_{xy}, \psi_x, \psi_y, \psi_{xy}$: membrane, flexural strains in local directions.

Modeller See [Results Tables \(Appendix K\)](#).

Local Axes

- **Local y axis** The local element y-axis at a point coincides with a curvilinear line $\xi = \text{constant}$ in the natural coordinate system which lies in the shell mid-surface.
- **Local x axis** The local x-axis at a point is perpendicular to the local y-axis in the positive η direction and is tangential to the shell mid-surface.
- **Local z axis** The local z-axis forms a right-hand set with the x and y axes and the direction is given by the ordering of the element nodes according to a right-hand screw rule. The local z-axis +ve direction defines the element top surface.

TSL6

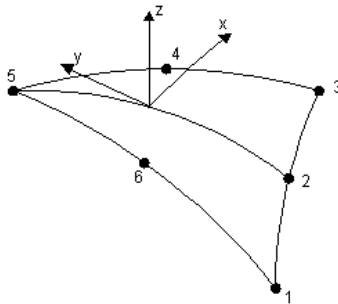

QSL8

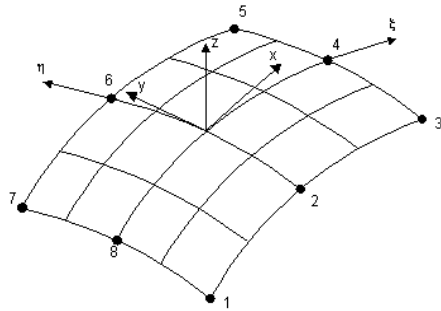

Sign Convention

- Thin shell element (see *Notes*).

Formulation

Geometric Nonlinearity

- Total Lagrangian** For large displacements, rotations up to 1 radian and small strains.
- Updated Lagrangian** For large displacements, rotation increments up to 1 radian and small strains.
- Eulerian** Not applicable.
- Co-rotational** Not applicable.

Integration Schemes

- Stiffness** Default. 3-point (TSL6), 5-point (QSL8).
 Fine (see *Options*). 3x3 (QSL8)
 Coarse (see *Options*). 2x2 (QSL8)
- Mass** Default. 3-point (TSL6), 5-point (QSL8).
 Fine (see *Options*). 3x3 (QSL8)

Mass Modelling

- Consistent mass (default).
- Lumped mass.

Options

- 18 Invokes fine integration rule.
- 19 Invokes coarse integration rule.
- 32 Suppresses stress output but not resultants.
- 34 Outputs element stress resultants.
- 54 Updated Lagrangian geometric nonlinearity.
- 55 Outputs strains as well as stresses
- 59 Outputs local direction cosines at nodes and Gauss points.
- 87 Total Lagrangian geometric nonlinearity.
- 102 Switch off load correction stiffness due to centripetal acceleration.
- 105 Lumped mass matrix.
- 138 Output yield flags only.
- 139 Output yielded Gauss points only.
- 169 Suppress extrapolation of stresses to nodes.
- 170 Suppress transfer of shape function arrays to disk.

Notes on Use

1. The element formulations are based on a [Kirchhoff](#) hypothesis for thin shells.
2. The variation of stresses within the elements may be regarded as linear.
3. The loof rotations refer to rotations about the element edge at the loof points. The positive direction of a loof rotation is defined by a right-hand screw rule applied to a vector running in the direction of the lower to higher numbered corner nodes. It should be noted that this direction is enforced on a global level which means that the loof rotations along the adjoining edge of several elements will be consistent in terms of direction and ordering. The ordering is such that loof point 1 is located between the lower numbered node and the appropriate mid-side node. Similarly loof point 2 lies between the mid-side node and the higher numbered node along an element edge. The loof rotations are actually specified at the element mid-side nodes.
4. The elements pass the [patch test](#) for convergence for mixed triangular and quadrilateral element geometry.
5. Stress output to the LUSAS output file is on 4 lines:
 - Stresses due to membrane action.
 - Top surface stresses due to bending action.
 - Top surface stresses due to membrane and bending action.
 - Bottom surface stresses due to membrane and bending action.

6. Stresses will not be output when using RIGIDITIES or material model 29. Averaged stresses will not be processed when using RIGIDITIES.
7. The through-thickness integration is performed explicitly for linear analyses and a 5-point [Newton-Cotes](#) rule is utilised for materially nonlinear analyses with continuum material models. The through-thickness integration rules are as follows:
 - Linear models: 3-layers.
 - Nonlinear models: 5-layers.
 - Composite model: Variable.
8. The quadrature points of the 3-point rule are non-standard.
9. The coarse 2*2 quadrature rule provides the most effective element if the mesh is highly constrained. However, the element possesses two mechanisms, the usual in-plane hourglass mechanism encountered when reduced integration is utilised with 8-noded elements and an out of plane mechanism. The in-plane mechanism is rarely activated but the out-of-plane mechanism may be more troublesome, particularly where elements are regular and have one zero principal curvature, e.g. a cylinder subject to internal pressure. Provided the mechanisms are not activated the element with 2*2 provides the best results.
10. The 5-point quadrature rule provides an element with a performance below that of the element with 2*2 quadrature, but considerably better than the element with 3*3 quadrature. However, the element possesses a 'near' mechanism which may be activated for lightly constrained meshes, particularly if out of plane loads are present.
11. The middle integration point of the 5 point rule is only implemented as a method of reducing the excitation of spurious modes (or mechanisms) which are present with the 2*2 integration rule. The 5th integration point is actually weighted with an arbitrarily small value which has the effect of stabilising the results. For these reasons, values from the middle integration point are not taken into account for the nodal extrapolation.
12. The 3*3 quadrature rule provides an element that has no mechanisms but tends to provide over-stiff solutions. Therefore, a finer discretisation is required than if the 5-point quadrature rule is used.

Restrictions

- [Ensure mid-side node centrality](#)
- [Avoid excessive element curvature](#)
- Avoid excessive aspect ratio

Recommendations on Use

- These elements may be utilised for analysing flat and curved 3D shell structures where the transverse shear effects do not influence the solution. The configuration of the nodal freedoms provides an element suitable for modelling intersecting shells, e.g. tubular joints and also for use with solid elements (HX20).
- The elements may be combined with the Semiloof beam (BSL3,BSL4,BXL4) for analysing ribbed plates and shells.

3D Thick Shell Elements

General

Element Name

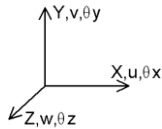

TTS3

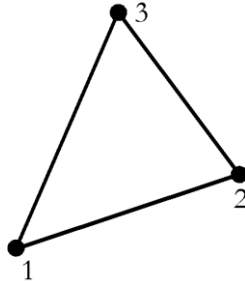

TTS6

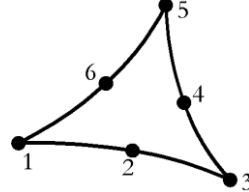

QTS4

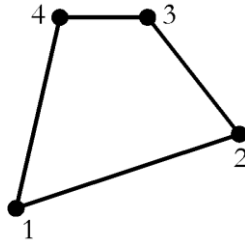

QTS8

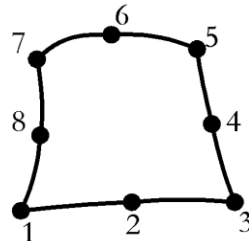

Element Group

Shells

Element

Thick Shells

Subgroup

Element

Description

A family of shell elements for the analysis of arbitrarily thick and thin curved shell geometries, including multiple branched junctions. The quadratic elements can accommodate generally curved geometry while all elements account for varying thickness. Anisotropic and composite material properties can be defined. These degenerate continuum elements are also capable of modelling warped configurations. The element formulation takes account of membrane, shear and flexural deformations. The quadrilateral elements use an assumed strain field to define transverse shear which ensures that the element does not lock when it is thin (see *Notes*).

Number Of

3, 4, 6 or 8 numbered anticlockwise.

Nodes

Freedom

Default: 5 degrees of freedom are associated with each node $U, V, W, \theta\alpha, \theta\beta$. To avoid singularities, the rotations $\theta\alpha$ and $\theta\beta$ relate to axes defined by the orientation of the normal at a node, see [Thick](#)

<p>Node Coordinates</p> <p>Nodal Freedoms</p>	<p>Shell Nodal Rotation. These rotations may be transformed to relate to the global axes in some instances (see <i>Notes</i>). Degrees of freedom relating to global axes: U, V, W, θ_x, θ_y, θ_z may be enforced using the Nodal Freedom data input, or for all shell nodes by using option 278 (see <i>Notes</i>).</p> <p>X, Y, Z: at each node.</p> <p>5 or 6.</p>
---	--

Geometric Properties

e_z , t_1 ... t_n **Eccentricity** and thickness at each node.

Material Properties

Linear	Isotropic:	MATERIAL PROPERTIES (Elastic: Isotropic)
	Orthotropic:	MATERIAL PROPERTIES ORTHOTROPIC THICK (Elastic: Orthotropic Thick)
		MATERIAL PROPERTIES ORTHOTROPIC SOLID (Elastic: Orthotropic Thick)
	Anisotropic:	MATERIAL PROPERTIES ANISOTROPIC 5 (Elastic: Anisotropic Thick Plate)
	Rigidities:	Not applicable.
Matrix	Not applicable	
Joint	Not applicable	
Concrete		MATERIAL PROPERTIES NONLINEAR 109 (Elastic: Isotropic, Plastic: Smoothed Multi-Crack Concrete)
Elasto-Plastic	Stress resultant:	Not applicable.
	Tresca:	MATERIAL PROPERTIES NONLINEAR 61 (Elastic: Isotropic, Plastic: Tresca, Hardening: Isotropic Hardening Gradient, Isotropic Plastic Strain or Isotropic Total Strain)
	Drucker-Prager:	MATERIAL PROPERTIES NONLINEAR 64 (Elastic: Isotropic, Plastic: Drucker-Prager, Hardening: Granular)
	Mohr-Coulomb:	MATERIAL PROPERTIES NONLINEAR 65 (Elastic: Isotropic, Plastic: Mohr-Coulomb, Hardening: Granular with Dilation)
	Volumetric Crushing:	Not applicable.
	Stress	STRESS POTENTIAL VON_MISES, HILL,

	Potential	HOFFMAN (Isotropic: von Mises, Modified von Mises Orthotropic: Hill, Hoffman)
Creep		CREEP PROPERTIES (Creep)
	AASHTO	MATERIAL PROPERTIES NONLINEAR 86 AASHTO (Concrete creep model to AASHTO Code of Practice)
	CEB-FIP	MATERIAL PROPERTIES NONLINEAR 86 CEB-FIP (Concrete creep model to CEB-FIP Model Code 1990)
	Chinese	MATERIAL PROPERTIES NONLINEAR 86 CHINESE (Chinese creep model to Chinese Code of Practice)
	Eurocode	MATERIAL PROPERTIES NONLINEAR 86 EUROCODE (Concrete creep model to EUROCODE_2)
	IRC	MATERIAL PROPERTIES NONLINEAR 86 IRC (Concrete creep model to Indian IRC Code of Practice)
Damage		DAMAGE PROPERTIES SIMO, OLIVER (Damage)
Viscoelastic Shrinkage	Not applicable	SHRINKAGE CEB_FIP_90, EUROCODE_2, GENERAL, USER
Rubber	Not applicable	
Generic Polymer	Not applicable	
Composite	Composite shell:	COMPOSITE PROPERTIES

Loading

Prescribed Value	PDSP, TPDSP	Prescribed variable. 5 degrees of freedom: U, V, W, $\theta\alpha$, $\theta\beta$ or 6 degrees of freedom: U, V, W, θ_x , θ_y , θ_z
Concentrated Loads	CL	Concentrated loads. 5 degrees of freedom: Px, Py, Pz, $M\alpha$, $M\beta$, where $M\alpha$ and $M\beta$ relate to axes defined by $\theta\alpha$ and $\theta\beta$ respectively. 6

		degrees of freedom: $P_x, P_y, P_z, M_x, M_y, M_z$.
Element Loads	Not applicable.	
Distributed Loads	UDL	Uniformly distributed loads. W_x, W_y, W_z : mid-surface local pressures for element (see Notes).
	FLD, FLDG	Not applicable.
Body Forces	CBF	Constant body forces for element. $X_{cbf}, Y_{cbf}, Z_{cbf}, \Omega_x, \Omega_y, \Omega_z, \alpha_x, \alpha_y, \alpha_z$ (see Notes).
	BFP, BFPE	Body force potentials at nodes/for element. $\phi_1, \phi_2, \phi_3, 0, X_{cbf}, Y_{cbf}, Z_{cbf}$, where ϕ_1, ϕ_2, ϕ_3 are the face loads in the local coordinate system (see Notes).
Velocities	VELO	Velocities. V_x, V_y, V_z : at nodes.
Accelerations	ACCE	Accelerations. A_x, A_y, A_z : at nodes.
Viscous Support Loads	VSL	Viscous support loads. VL_x, VL_y, VL_z : at nodes.
Initial Stress/Strains	SSI, SSIE	Initial stresses/strains at nodes/for element (see Notes).
	SSIG	Initial stresses/strains at Gauss points. Stress/strain components relating to local axes at Gauss points: $\sigma_x, \sigma_y, \sigma_{xy}, \sigma_{yz}, \sigma_{xz}, \epsilon_x, \epsilon_y, \gamma_{xy}, \gamma_{yz}, \gamma_{xz}$. All of these 10 terms are repeated for each fibre integration point through the thickness (see <i>Notes</i>).
Residual Stresses	SSR, SSRE	Not applicable.
	SSRG	Residual stresses at Gauss points. Stress components relating to local axes at Gauss points: $\sigma_x, \sigma_y, \sigma_{xy}, \sigma_{yz}, \sigma_{xz}$ all of these 5 terms are repeated for each fibre integration point through the thickness (see <i>Notes</i>).
Target Stress/Strains	TSSIE, TSSIA	Target stresses/strains at nodes/for element (see Notes).
	TSSIG	Target stresses/strains at Gauss points. Stress/strain components relating to local axes at Gauss points: $\sigma_x, \sigma_y, \sigma_{xy}, \sigma_{yz}, \sigma_{xz}, \epsilon_x, \epsilon_y, \gamma_{xy}, \gamma_{yz}, \gamma_{xz}$. All of these 10 terms are repeated for each fibre integration point through the thickness (see <i>Notes</i>).
Temperatures	TEMP, TMPE	Temperatures at nodes/for element. $T, 0, 0, dT/dz, T_0, 0, 0, dT_0/dz$ (see Notes).

Overburden	Applicable.
Phreatic Surface	Applicable.
Field Loads	Not applicable.
Temp Dependent Loads	Not applicable.

LUSAS Output

Solver	Stress resultant: $N_x, N_y, N_{xy}, M_x, M_y, M_{xy}, S_x, S_y$: forces, moments/unit width in local directions. Stress (default): $\sigma_x, \sigma_y, \sigma_{xy}, \sigma_{yz}, \sigma_{xz}, \sigma_e$: in local directions (see <i>Notes</i>). Strain: $\epsilon_x, \epsilon_y, \gamma_{xy}, \gamma_{yz}, \gamma_{xz}, \epsilon_e$: in local directions (see <i>Notes</i>).
Modeller	See Results Tables (Appendix K) .

Local Axes

The local element x-axis at a point coincides with a curvilinear line $\eta = \text{constant}$ in the natural coordinate system which lies in the shell mid-surface. The local z-axis at a point is obtained from the cross product of a curvilinear line $\xi = \text{constant}$ in the natural coordinate system and the local x-axis. The local y-axis forms a right-hand set with the x and z axes and the direction is given by the ordering of the element nodes according to a right-hand screw rule. The local z-axis +ve direction defines the element top surface.

TTS6

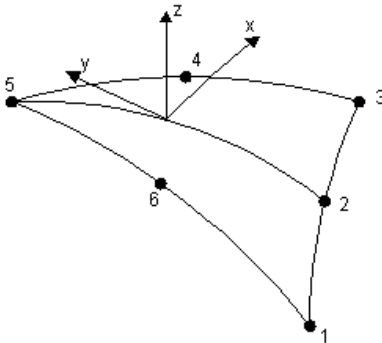

QTS8

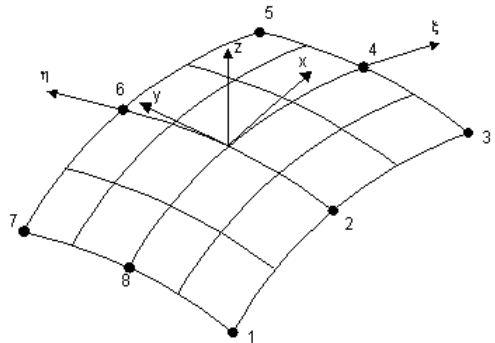

Sign Convention

- Thick shell element (see *Notes*).

Formulation

Geometric Nonlinearity

Total Lagrangian	For large displacements, large rotations and small strains.
Updated Lagrangian	Not applicable.
Eulerian	Not applicable.
Co-rotational	Not applicable.

Integration Schemes

Stiffness	Default.	1-point (TTS3), 3-point (TTS6), 2x2 (QTS4, QTS8).
	Fine (see <i>Options</i>).	3-point (TTS3), 5-point (QTS8)
Mass	Default.	1-point (TTS3), 3-point (TTS6), 2x2 (QTS4, QTS8).
	Fine (see <i>Options</i>).	3-point (TTS3), 5 point (QTS8)

Mass Modelling

- Consistent mass (default).
- Lumped mass.

Options

- 18** Invokes fine integration rule.
- 32** Suppresses stress output but not resultants.
- 34** Outputs element stress resultants.
- 55** Outputs strains as well as stresses.
- 59** Outputs local direction cosines at nodes and Gauss points.
- 77** Outputs principal stresses.
- 87** Total Lagrangian geometric nonlinearity.
- 102** Switch off load correction stiffness due to centripetal acceleration.
- 105** Lumped mass matrix.
- 110** Use assumed shear strain field for TTS6 and QTS8 thick shell elements.
- 139** Output yielded Gauss points only.
- 169** Suppress extrapolation of stresses to nodes.
- 171** Switch off assumed strain field for QTS4 elements.
- 278** Six degrees of freedom.
- 396** Invokes the improved transverse shear calculation ('on' by default for models created by version 14.4 and above, and 'off' - for models created by

previous versions).

- 417 Introduce residual bending flexibility correction for 3-node thick shell TTS3.
- 422 Use assumed transverse shear strain field for TTS3 thick shell element.

Notes on Use

1. For TTS3 elements all moments and shears are constant for the element. For QTS4 the variations of moments, out of plane shears and in-plane loads is near-constant and the variation of in-plane shear is near-linear. For TTS6 and QTS8 elements the variation of moments and in-plane shear is near-linear while the variation of out of plane shears is near constant.
2. Shear locking is much more of an issue for lower order elements, and hence an assumed shear strain field is always switched on for TTS3/QTS4 elements; if it were switched off, these elements would always lock and perform very badly. Higher order elements are less prone to shear locking, and the situation is not quite so clear cut. It has been found that using an assumed shear strain field with QTS8 elements when transverse shear strain dominates can lead to poor results. The view has therefore been taken that the assumed shear strain field should be switched off by default for the higher order TTS6/QTS8 elements.
3. The QTS8 element fails the shear [patch test](#) when the assumed strain field is utilised with 2*2 or 5 point integration rule. When carrying out analyses involving these elements that are dominated by transverse shear effects, e.g. a shear wall, it is recommended, as discussed above, that the assumed strain field is disabled. This is the default setting for QTS8 elements. Option 110 may be used to invoke the assumed strain interpolation but this is not recommended for general use.
4. The assumed strain field is invoked automatically for QTS4 elements. The assumed strain field may be revoked for QTS4 by specifying Option 171.
5. The introduction of assumed transverse shear strains (Option 422) significantly improves the performance of the TTS3 element. The RBF correction (Option 417) further improves the TTS3 element, especially for very thin shells. For elasto-plastic materials, the correction matrix is computed using the linear material properties
6. Continuum stresses (and strains using Option 55) at each fibre integration point are output by default. For linear materials these stresses relate to the top, middle and bottom surfaces of the element. If a nonlinear material is specified then stresses are output at 5 points through the thickness after material yield.
7. Option 55 must be specified if nonlinear state variables are to be written to the LUSAS output file.
8. The through-thickness integration rules are as follows:

- Linear material models: 3-layers.
 - Nonlinear material models: 5-layers.
 - Composite model: variable.
7. Initial stresses/strains must be specified at 3 layers for a linear material or 5 layers for a nonlinear material. Residual stresses must be specified for 5 layers. In all instances the stresses/strains are specified sequentially from the bottom surface to the top.
 8. There are usually 2 rotational degrees of freedom and a common nodal normal associated with each node giving a smooth surface to the shell assembly:

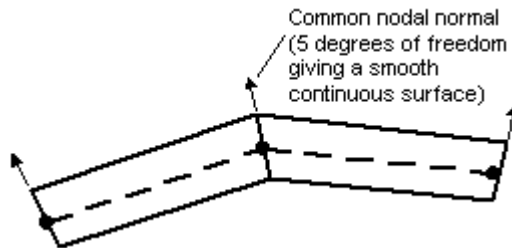

The direction of the axes defining the rotations depends upon the orientation of the normal at a node (see [Thick Shell Nodal Rotation](#)). In certain circumstances 3 rotational degrees of freedom relating to global axes will be assigned to a node. This is done automatically:

- When connecting with beam elements, joint elements or other types of shells, eg.QSI4.
- When a Concentrated Load is applied in LUSAS Modeller.
- When a Support is applied in LUSAS Modeller.
- When the angle between adjacent shell normals exceeds the SYSTEM parameter SHLANG (see below).
- When option 278 is specified.

If Option 278 is specified then all nodes for these shell element types will be assigned six global degrees of freedom. To overcome the problems associated with in-plane drilling rotations an artificial stiffness is automatically included for the rotation about the shell normal. The use of Option 278 is not recommended for analyses that involve large displacements or rotations. LUSAS Modeller will automatically specify Option 278 but it can be switched off in Modeller via File > Model Properties > Solution > Element options.

Option 278 should be switched **off** if QTS4 elements are to be used to model thick curved shells in which membrane action leads to a significant difference between the in-plane strains in the top and bottom surface of the shell. If Option 278 is not disabled under these circumstances the moments associated with this in-plane strain differential are not accurately accounted for. An alternative approach would be to switch to QTS8 elements as these elements produce more accurate moments under these conditions.

When the maximum angle between adjacent normals at a node is greater than 20 degrees, e.g., branched shell structures. (20 degrees is a default value which may be changed using the SYSTEM parameter SHLANG); if the nodal freedom command has **not** been specified for that node.

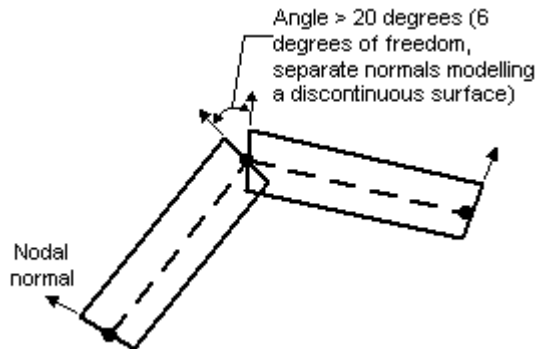

9. A system variable (STFINP) is used to alter the artificial stiffness for in-plane rotations. This system parameter can only be used in conjunction with Option 278.
10. The desired number of rotational degrees of freedom for a node may be enforced through the NODAL FREEDOMS data input. Care must be taken if 6 degrees of freedom are specified in this manner as a singularity may occur if appropriate in-plane rotations are not restrained. This facility is provided together with the TRANSFORMED FREEDOMS data chapter to allow more flexibility in the specification of boundary conditions. In these circumstances, the in-plane rotation about the normal of the shell must usually be restrained to avoid singularities. In general, wherever possible, 5 degrees of freedom should be used when the shell surface is smooth.
11. The TTS3 and QTS8 elements possess one out of plane mechanism when using the default integration rules. The 3 noded element is most effective using the one point rule.
12. The through-thickness integration is performed by utilising a 3 point [Newton-Cotes](#) rule for linear materials and a 5 point rule for nonlinear materials and

- creep. In an analysis involving material nonlinearity, a 3 point rule is used until the material yields and then a 5 point rule is invoked.
13. The thick shell formulation assumes constant transverse shear deformation. In the post-processing stage, after the application of the constitutive relationship, this results in a constant transverse shear stress. This result can be improved by taking into account the true parabolic shear stress distribution while preserving the same shear resultant. Thus, when Option 396 is used, the transverse shear stresses for a non-layered shell are set to zero at the top and bottom and to 1.5 times the constant value at the middle. For a layered shell, the distribution of the transverse shear depends on the in-plane stiffness of the layers. The output results are for the middle of the layer, thus the top and bottom layers will not have zero transverse shear.
 14. The ORTHOTROPIC SOLID material model may be used with either composite or non-composite thick shell elements. Using a Solid rather than a Thick orthotropic material means that a local coordinate may be used to orientate the material.
 15. If applying an initial stress/strain or thermal load that varies across an element, a higher order element (6 or 8 nodes) should be used. A limitation of the standard isoparametric approach when used for lower order elements (3 or 4 nodes) is that only constant stress/strain fields can be imposed correctly.
 16. For an element with eccentricity the following load types are applied at the mid-plane of the element (not the nodal plane): UDL, CBF, BFP, BFPE, SSI, SSIE, SSIG, SSRG, TSSIE, TSSIA, TSSIG, TEMP, TMPE.
 17. The Smoothed Multi Crack Concrete Model (109) can be used with this element, however, due to the “plane sections remaining plane” hypothesis, crack widths cannot be computed.

Restrictions

- [Ensure mid-side node centrality](#)
- [Avoid excessive element curvature](#)
- Avoid excessive aspect ratio

Recommendations on Use

- These elements may be utilised for analysing flat and curved 3D shell structures where it is necessary to account for transverse shear. This typically involves thick shell structures where transverse shear deformation can have a considerable influence on the response. The degenerate continuum formulation also allows the low order quadrilateral element (QTS4) to successfully model warped shell configurations.

- The elements may be used for modelling intersecting shells or branched shell junctions. In this instance the nodal rotation freedoms are transformed to relate to the global axes. For modelling stiffened shell structures, the shells may be connected to beam elements BMI21.
- This family of thick shell elements offers a consistent formulation of the tangent stiffness which makes them particularly effective in geometrically nonlinear applications.
- Be aware that when the shell is defined with eccentricity to a reference surface and this reference surface does not pass through the centroid of the cross section, membrane forces or displacements prescribed/calculated at the nodes will cause bending.

Chapter 7 : Membrane Elements

2D Axisymmetric Membrane Elements

General

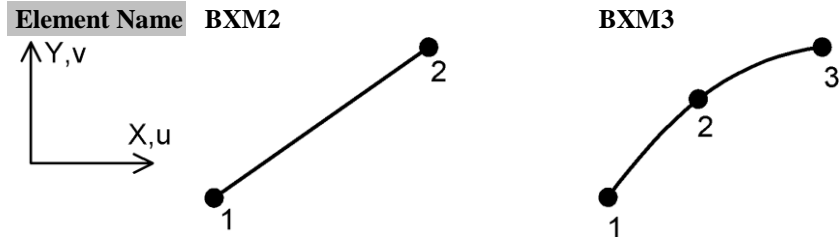

Element Group	Membranes
Element Subgroup	Axisymmetric Membranes
Element Description	Straight and curved axisymmetric membrane elements which can accommodate varying thickness. The formulations apply over a unit radian segment of the structure. The loading and boundary conditions are axisymmetric. The elements are numerically integrated. The default axis of symmetry is the Y-axis.
Number Of Nodes	2 or 3.
Freedom Node Coordinates	U, V: at each node. X, Y: at each node.

Geometric Properties

$t_1 \dots t_n$ Thickness at each node.

Material Properties

Linear	Isotropic:	MATERIAL PROPERTIES (Elastic: Isotropic)
Matrix	Not applicable	
Joint	Not applicable	
Concrete	Not applicable	
Elasto-Plastic	Tresca:	MATERIAL PROPERTIES NONLINEAR 61 (Elastic: Isotropic, Plastic: Tresca, Hardening: Isotropic Hardening Gradient, Isotropic Plastic Strain or Isotropic Total Strain)
	Drucker-Prager:	MATERIAL PROPERTIES NONLINEAR 64

		(Elastic: Isotropic, Plastic: Drucker-Prager, Hardening: Granular)
	Mohr-Coulomb:	MATERIAL PROPERTIES NONLINEAR 65 (Elastic: Isotropic, Plastic: Mohr-Coulomb, Hardening: Granular with Dilation)
	Optimised Implicit Von Mises:	MATERIAL PROPERTIES NONLINEAR 75 (Elastic: Isotropic, Plastic: Von Mises, Hardening: Isotropic & Kinematic)
	Volumetric Crushing:	Not applicable.
	Stress Potential	STRESS POTENTIAL VON_MISES (Isotropic: von Mises, Modified von Mises)
Creep		CREEP PROPERTIES (Creep)
Damage		DAMAGE PROPERTIES SIMO, OLIVER (Damage)
Viscoelastic	Not applicable	
Shrinkage		SHRINKAGE CEB_FIP_90, EUROCODE_2, GENERAL, USER
Rubber	Ogden:	MATERIAL PROPERTIES RUBBER OGDEN (Rubber: Ogden) (See Restrictions)
	Mooney-Rivlin:	MATERIAL PROPERTIES RUBBER MOONEY_RIVLIN (Rubber: Mooney-Rivlin) (See Restrictions)
	Neo-Hookean:	MATERIAL PROPERTIES RUBBER NEO_HOOKEAN (Rubber: Neo-Hookean) (See Restrictions)
	Hencky:	Not applicable.
Generic Polymer	Not applicable	
Composite	Not applicable	
Field	Not applicable	
Loading		
Prescribed Value	PDSP, TPDSP	Prescribed variable. U, V: at nodes.
Concentrated Loads	CL	Concentrated loads. Px, Py: at nodes.
Element Loads	Not applicable.	
Distributed Loads	UDL	Not applicable.
	FLD	Face Loads . Px, Py: local face pressure at

	FLDG	nodes.
Body Forces	CBF	Not applicable
	BFP, BFPE	Constant body forces for element. Xcbf, Ycbf, Ω_x , Ω_y , Ω_z , α_z
Velocities	VELO	Body force potentials at nodes/for element. 0, 0, 0, 0, Xcbf, Ycbf
Accelerations	ACCE	Velocities. Vx, Vy: at nodes.
Viscous Support Loads	VSL	Accelerations. Ax, Ay: at nodes.
Initial Stress/Strains	SSI, SSIE	Viscous support loads. VLx, VLy: at nodes.
	SSIG	Initial stresses/strains at nodes/for element.
Residual Stresses	SSR, SSRE	σ_x , σ_θ : axial, circumferential stress.
	SSRG	ϵ_x , ϵ_θ : axial, circumferential strain.
Target Stress/Strains	TSSIE, TSSIA	Initial stresses/strains at Gauss points.
	TSSIG	σ_x , σ_θ : axial, circumferential stress.
Temperatures	TEMP, TMPE	ϵ_x , ϵ_θ : axial, circumferential strain.
Overburden	Not applicable.	Not applicable.
Phreatic Surface	Not applicable.	Not applicable.
Field Loads	Not applicable.	Not applicable.
Temp Dependent Loads	Not applicable.	Not applicable.

LUSAS Output

Solver Stress (default): σ_x , σ_θ : axial, circumferential stress.

Strain: ϵ_x , ϵ_θ : axial, circumferential strain.

Modeller See [Results Tables \(Appendix K\)](#).

Local Axes

- [Standard line element](#)

Sign Convention

- [Standard membrane element](#)

Formulation

Geometric Nonlinearity

Total Lagrangian	For large displacements and small strains.
Updated Lagrangian	Not applicable.
Eulerian	Not applicable.
Co-rotational	Not applicable.

Integration Schemes

Stiffness	Default.	1-point (BXM2), 2-point (BXM3).
	Fine (see <i>Options</i>).	2-point (BXM2).
Mass	Default.	1-point (BXM2), 2-point (BXM3).
	Fine (see <i>Options</i>).	2-point (BXM2).

Mass Modelling

- Consistent mass (default).
- Lumped mass.

Options

- 18** Invokes fine integration rule.
- 36** Follower loads (see *Notes*).
- 47** Use the X-axis as the axis of symmetry.
- 55** Output strains as well as stresses.
- 87** Total Lagrangian geometric nonlinearity.
- 105** Lumped mass matrix.

170 Suppress transfer of shape function arrays to disk

Notes on Use

1. The element formulation is based on the standard [isoparametric](#) approach.
2. The variation of stress along the element is constant for BXM2 and linear for BXM3.
3. To apply a non-conservative (follower) pressure load (load type FLD), Option 36 must be specified. Note that this load should be normal to the face and constant for all the nodes of the element. Follower load can only be used with BXM2 elements.
4. The elements should not be used as 'stand-alone' elements if any bending effects are present. The thin axisymmetric shell element BXS3 should be used for this case.
5. The BXM3 element has a zero energy mode which may be excited if the midside node is free and not connected to any other element.
6. When BXM2 elements are used with either variable nodal thicknesses, temperature dependent material properties or utilised in materially nonlinear analyses the 2-point Gauss rule is most effective.

Restrictions

- [Ensure mid-side node centrality](#)
- Avoid excessive element curvature
- Rubber material models can only be used with element BXM2 and must be used with Total Lagrangian geometric nonlinearity (Option 87).

Recommendations on Use

The elements may be used alone to model circular plates or pipes, or coupled with axisymmetric solid elements to provide stiffeners, e.g. radial reinforcement.

3D Space Membrane Elements

General

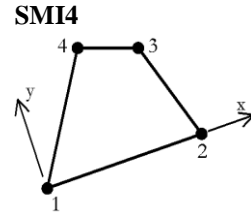
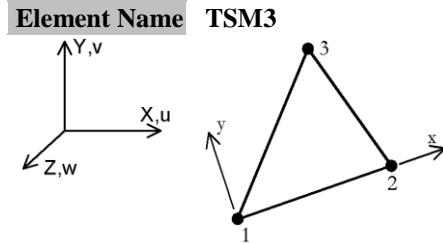

Element Group	Membranes
Element Subgroup	Space Membranes
Element Description	A family of space membrane elements in 3D which include a high performance incompatible model (SMI4 only). The elements are intended for 3D membrane structures (they possess no bending stiffness). The elements are formulated in the local element axes which allows directional material properties to be defined relative to the element orientation. The elements can accommodate varying thickness.
Number Of Nodes	3 or 4 numbered anticlockwise.
Freedom Node	U, V, W: at each node.
Coordinates	X, Y, Z: at each node.

Geometric Properties

$t_1... t_n$ Thickness at each node.

Material Properties

Linear Isotropic:	MATERIAL PROPERTIES (Elastic: Isotropic)
Orthotropic:	MATERIAL PROPERTIES ORTHOTROPIC (Elastic: Orthotropic Plane Stress)
Anisotropic:	MATERIAL PROPERTIES ANISOTROPIC 3 (Elastic: Anisotropic Thin Plate)
Rigidities:	RIGIDITIES 3 (Rigidities: Membrane/Thin Plate)

Matrix	Not applicable
Joint	Not applicable
Concrete	Not applicable
Elasto-Plastic	Not applicable
Creep	Not applicable
Damage	Not applicable
Viscoelastic	Not applicable
Shrinkage	
Rubber	Not applicable
Generic Polymer	Not applicable
Composite	Not applicable

SHRINKAGE CEB_FIP_90,
EUROCODE_2, GENERAL, USER

Loading

Prescribed Value	PDSP, TPDSP	Prescribed variable. U, V, W: at nodes.
Concentrated Loads	CL	Concentrated loads. Px, Py, Pz: at nodes.
Element Loads	Not applicable.	
Distributed Loads	UDL	Uniformly distributed loads. Wx, Wy, Wz: local surface pressures for element.
	FLD, FLDG	Not applicable.
Body Forces	CBF	Constant body forces for element. Xcbf, Ycbf, Zcbf, Ω_x , Ω_y , Ω_z , α_x , α_y , α_z
	BFP, BFPE	Body force potentials at nodes/for element. ϕ_1 , ϕ_2 , ϕ_3
Velocities	VELO	Velocities. Vx, Vy, Vz: at nodes.
Accelerations	ACCE	Accelerations. Ax, Ay, Az: at nodes.
Viscous Support Loads	VSL	Viscous support loads. VLx, VLy, VLz: at nodes.
Initial Stress/Strains	SSI, SSIE	Initial stresses/strains at nodes/for element. Nx, Ny, Nxy: forces in local directions. ϵ_x , ϵ_y , γ_{xy} : membrane strains in local directions.
	SSIG	Initial stresses/strains at Gauss points. Nx, Ny, Nxy: forces in local directions. ϵ_x , ϵ_y , γ_{xy} : membrane strains in local directions.
Residual Stresses	Not applicable.	
Target	TSSIE,	Target stresses/strains at nodes/for element. Nx,

Stress/Strains	TSSIA	N_y, N_{xy} : forces in local directions. $\epsilon_x, \epsilon_y, \gamma_{xy}$: membrane strains in local directions.
	TSSIG	Target stresses/strains at Gauss points. N_x, N_y, N_{xy} : forces in local directions. $\epsilon_x, \epsilon_y, \gamma_{xy}$: membrane strains in local directions.
Temperatures	TEMP, TMPE	Temperatures at nodes/for element. T, 0, 0, 0, T_o , 0, 0, 0
Overburden	Not applicable.	
Phreatic Surface	Not applicable.	
Field Loads	Not applicable.	
Temp Dependent Loads	Not applicable.	

Output

Solver	Stress resultant: $N_x, N_y, N_{xy}, N_{max}, N_{min}$, β : forces/unit length in local directions.
	Stress (default): $\sigma_x, \sigma_y, \sigma_{xy}, \sigma_{max}, \sigma_{min}$, β : membrane stresses in local directions.
	Strain: $\epsilon_x, \epsilon_y, \gamma_{xy}, \epsilon_{max}, \epsilon_{min}$, β : membrane strains in local directions.

Modeller See [Results Tables \(Appendix K\)](#).

Local Axes

- Standard area element

Sign Convention

- Standard membrane element

Formulation

Geometric Nonlinearity

Not applicable.

Integration Schemes

Stiffness Default. 1-point (TSM3), 2x2 (SMI4).

	Fine.	As default.
Mass	Default.	1-point (TSM3), 2x2 (SMI4).
	Fine.	As default.

Mass Modelling

Lumped mass only.

Options

- 32 Suppress stress output but not stress resultants.
- 34 Output stress resultants.
- 55 Output strains as well as stresses.
- 59 Output local direction cosines for elements.
- 77 Output averaged global stresses.

Notes on Use

1. The element formulations are based on the standard
2. The variation of stresses within an element may be regarded as constant for TSM3 and linear for SMI4.
3. The higher performance of SMI4 is due to the addition of 4 incompatible displacement modes.
4. The elements pass the [patch test](#) for mixed triangular and quadrilateral geometry.
5. Distributed loads are lumped at the nodes.
6. The element is formulated so that the material response is evaluated in the local Cartesian system.
7. The SMI4 element is generally the most effective element due to its quadratic displacement accuracy. However, its behaviour tends to deteriorate as the element becomes distorted.
8. The element matrices are formed using 1-point Gauss quadrature for TSM3. Selective integration is utilised for the evaluation of the element matrices for SMI4. The method used is similar to that proposed by Hughes, with the contribution of the incompatible modes to the strain-displacement matrix being evaluated at the 1-point Gauss rule sampling location and then extrapolated to the 2*2 Gauss rule sampling locations. The element matrices are then formed using the 2*2 Gauss rule.

Restrictions

- ❑ Avoid excessive aspect ratio.
- ❑ Avoid excessive warping.

Recommendations on Use

- The space membrane elements have limited 'stand-alone' use because of their inability to support any loading except membrane loading. However, they can be utilised with the flat shell elements (QSI4, TS3) to model very thin membranes in structural components.
- If a structure is composed of exactly co-planar flat space membrane elements that are not stiffened by plate or shell elements, singularities may arise since there is no out-of-plane stiffness.
- If there is a possibility of bending behaviour then a thin shell should be utilised for the analysis.

Chapter 8 : Joint Elements

2D Joint Element for Bars, Plane Stress and Plane Strain

General

Element Name JNT3

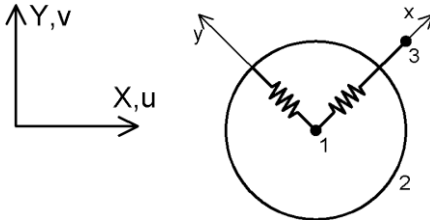

Element Group	Joints
Element Subgroup	2D Joints
Element Description	A 2D joint element which connects two nodes by two springs in the local x and y-directions.
Number Of Nodes	3. The 3rd node is used to define the local x-direction.
Freedom	U, V: at nodes 1 and 2 (active nodes).
Node Coordinates	X, Y: at each node.

Geometric Properties

Not applicable.

Material Properties

Linear	Not applicable
Matrix	Stiffness: MATRIX PROPERTIES STIFFNESS 4 K1,..., K10 element stiffness matrix (Not supported in LUSAS Modeller)
	Mass: MATRIX PROPERTIES MASS 4 M1,..., M10 element mass matrix (Not supported in LUSAS Modeller)
	Damping: MATRIX PROPERTIES DAMPING 4 C1,..., C10 element damping matrix (Not supported in LUSAS Modeller)
Joint	Standard: JOINT PROPERTIES 2 (Joint: 2/Spring Stiffness Only)

Dynamic general:	JOINT PROPERTIES GENERAL 2 (Joint: 2/General Properties)
Elasto-plastic:	JOINT PROPERTIES NONLINEAR 31 2 (Joint: 2/Elasto-Plastic (Tension and Compression Equal))
Elasto-plastic:	JOINT PROPERTIES NONLINEAR 32 2 (Joint: 2/Tension and Compression Unequal)
Nonlinear contact:	JOINT PROPERTIES NONLINEAR 33 2 (Joint: 2/Smooth Contact)
Nonlinear friction:	JOINT PROPERTIES NONLINEAR 44 2 (Joint: 2/Frictional Contact)
Viscous damping:	JOINT PROPERTIES NONLINEAR 35 2 (Joint: 2/Viscous Damper)
Lead-rubber:	JOINT PROPERTIES NONLINEAR 36 2 (Joint: 2/Lead Rubber Bearing)
Friction pendulum:	JOINT PROPERTIES NONLINEAR 37 2 (Joint: 2/Frictional Pendulum System)
Multi-linear elastic	JOINT PROPERTIES NONLINEAR 40 2 (Joint: 2/Multi-Linear Elastic)
Multi-linear hysteresis	JOINT PROPERTIES NONLINEAR 41 2 (Joint: 2/Multi-Linear Hysteresis)
Multi-linear compound hysteresis	JOINT PROPERTIES NONLINEAR 42 2 (Joint: 2/Multi-Linear Compound Hysteresis)
Axial force dependent multi-linear elastic	JOINT PROPERTIES NONLINEAR 43 2 (Joint: 2/Axial Force Dependent Multi-Linear Elastic)
Concrete	Not applicable
Elasto-Plastic	Not applicable
Creep	Not applicable
Damage	Not applicable
Viscoelastic	Not applicable
Shrinkage	Not applicable
Rubber	Not applicable
Generic Polymer	Not applicable
Composite	Not applicable

Loading

Prescribed Value	PDSP, TPDSP	Prescribed variable. U, V: at active nodes.
Concentrated Loads	CL	Concentrated loads. Px, Py: at active nodes.

Element Loads	Not applicable.	
Distributed Loads	Not applicable.	
Body Forces	CBF	Constant body forces for element. Xcbf, Ycbf, Ω_x , Ω_y , Ω_z , α_z
	BFP, BFPE	Not applicable.
Velocities	VELO	Velocities. Vx, Vy: at nodes.
Accelerations	ACCE	Accelerations. Ax, Ay: at nodes.
Viscous Support Loads	VSL	Viscous support loads. VLx, VLy: at nodes.
Initial Stress/Strains	SSI, SSIE	Initial stresses/strains at nodes/for element. Fx, Fy: at active nodes. ϵ_x , ϵ_y : at active nodes.
	SSIG	Not applicable.
Residual Stresses	Not applicable.	
Target Stress/Strains	TSSIE, TSSIA	Target stresses/strains at nodes/for element. Fx, Fy: at active nodes. ϵ_x , ϵ_y : at active nodes.
	TSSIG	Not applicable.
Temperatures	TEMP, TMPE	Temperatures at nodes/for element. T1, T2, T10, T20: actual and initial spring temperatures.
Overburden	Not applicable.	
Phreatic Surface	Not applicable.	
Field Loads	Not applicable.	
Temp Dependent Loads	Not applicable.	

LUSAS Output

Solver	Force: Fx, Fy: spring forces in local directions. Strain: ϵ_x , ϵ_y : spring strains in local directions.
Modeller	See Results Tables (Appendix K) .

Local Axes

- ❑ [Standard joint element](#)

Sign Convention

- [Standard joint element](#)

Formulation

Geometric Nonlinearity

Not applicable.

Integration Schemes

Stiffness	Default.	1-point.
	Fine.	As default.
Mass	Default.	1-point.
	Fine.	As default.

Mass Modelling

Lumped mass only. The position of the mass relative to the two active joint nodes is defined in the joint material data. Point mass elements should be used to model lumped masses when no stiffness modelling is required.

Options

- 55 Output strains as well as stresses.
- 119 Invokes temperature input for joints.

Notes on Use

See [Joint Element Compatibility and Notes \(Appendix L\)](#).

Restrictions

Not applicable.

Recommendations on Use

- The joint elements may be used to release degrees of freedom between elements, e.g. a hinged shell, or to provide nonlinear support conditions, e.g. friction-gap condition. Also, point masses may be represented by including a joint at an element node.
- See [Joint Element Compatibility \(Appendix L\)](#)

2D Joint Element for Engineering and Kirchhoff Beams

General

Element Name

JPH3

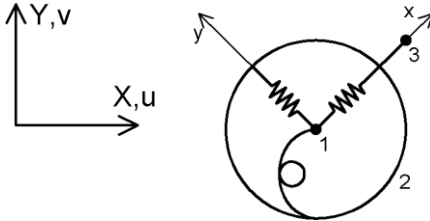

Element Group

Joints

Element

2D Joints

Subgroup

Element Description

A 2D joint element which connects two nodes by two springs in the local x and y-direction and one spring about the local z-direction.

Number Of Nodes

3. The 3rd node is used to define the local x-direction.

Freedom

U, V, θ_z : at nodes 1 and 2 (active nodes).

Node

X, Y: at each node.

Coordinates

Geometric Properties

ey Eccentricity measured from the joint x axis to the nodal line (i.e. parallel to the joint y axis).

dy Parametric distance factor (between 0.0 and 1.0), which defines the position of the shear spring for the local y direction between nodes 1 and 2. It is measured from node 1 ($dy=0$) along the local x direction

Material Properties

Linear Not applicable

Matrix Stiffness:

MATRIX PROPERTIES STIFFNESS 6 K1, ..., K21 element stiffness matrix (Not supported in LUSAS Modeller)

Mass:

MATRIX PROPERTIES MASS 6 M1, ..., M21 element mass matrix (Not supported in LUSAS Modeller)

Damping:

MATRIX PROPERTIES DAMPING 6 C1, ..., C21 element damping matrix (Not supported)

		in LUSAS Modeller)
Joint	Standard:	JOINT PROPERTIES 3 (Joint: 3/Spring Stiffness Only)
	Dynamic general:	JOINT PROPERTIES GENERAL 3 (Joint: 3/General Properties)
	Elasto-plastic:	JOINT PROPERTIES NONLINEAR 31 3 (Joint: 3/Elasto-Plastic (Tension and Compression Equal))
	Elasto-plastic:	JOINT PROPERTIES NONLINEAR 32 3 (Joint: 3/Tension and Compression Unequal)
	Nonlinear contact:	JOINT PROPERTIES NONLINEAR 33 3 (Joint: 3/Smooth Contact)
	Nonlinear friction:	JOINT PROPERTIES NONLINEAR 44 3 (Joint: 3/Frictional Contact)
	Viscous damping:	JOINT PROPERTIES NONLINEAR 35 3 (Joint: 3/Viscous Damper)
	Lead-rubber:	JOINT PROPERTIES NONLINEAR 36 3 (Joint: 3/Lead Rubber Bearing)
	Friction pendulum:	JOINT PROPERTIES NONLINEAR 37 3 (Joint: 3/Frictional Pendulum System)
	Multi-linear elastic	JOINT PROPERTIES NONLINEAR 40 3 (Joint: 3/Multi-Linear Elastic)
	Multi-linear hysteresis	JOINT PROPERTIES NONLINEAR 41 3 (Joint: 3/Multi-Linear Hysteresis)
	Multi-linear compound hysteresis	JOINT PROPERTIES NONLINEAR 42 3 (Joint: 3/Multi-Linear Compound Hysteresis)
	Axial force dependent multi-linear elastic	JOINT PROPERTIES NONLINEAR 43 3 (Joint: 3/Axial Force Dependent Multi-Linear Elastic)
Joint	Standard:	JOINT PROPERTIES 3 (Joint: 3/Spring Stiffness Only)
	Dynamic general:	JOINT PROPERTIES GENERAL 3 (Joint: 3/General Properties)
Concrete	Not applicable	
Elasto-Plastic	Not applicable	
Creep	Not applicable	
Damage	Not applicable	
Viscoelastic	Not applicable	

Shrinkage applicable
Not applicable

Rubber Not applicable
Generic Polymer Not applicable
Composite Not applicable

Loading

Prescribed Value	PDSP, TPDSP	Prescribed variable. U, V, θ_z : at active nodes.
Concentrated Loads	CL	Concentrated loads. Px, Py, Mz: at active nodes.
Element Loads	Not applicable	
Distributed Loads	Not applicable	
Body Forces	CBF	Constant body forces for element. Xcbf, Ycbf, $\Omega_x, \Omega_y, \Omega_z, \alpha_z$
Velocities	BFP, BFPE VELO	Not applicable. Velocities. Vx, Vy: at nodes.
Accelerations	ACCE	Accelerations. Ax, Ay: at nodes.
Viscous Support Loads	VSL	Viscous support loads. VLx, VLy: at nodes.
Initial Stress/Strains	SSI, SSIE	Initial stresses/strains at nodes/for element. Resultants. Fx, Fy, Mz: spring forces and moment in local directions. $\epsilon_x, \epsilon_y, \psi_z$: strains at nodes.
Residual Stresses	SSIG Not applicable	Not applicable.
Target Stress/Strains	TSSIE, TSSIA	Target stresses/strains at nodes/for element. Resultants. Fx, Fy, Mz: spring forces and moment in local directions. $\epsilon_x, \epsilon_y, \psi_z$: strains at nodes.
Temperatures	TSSIG TEMP, TMPE	Not applicable. Temperatures at nodes/for element. T1, T2, T3, T10, T20, T30: actual and initial spring

temperatures.

Overburden	Not applicable.
Phreatic Surface	Not applicable.
Field Loads	Not applicable
Temp Dependent Loads	Not applicable

LUSAS Output

Solver	Force: Fx, Fy, Mz: spring forces and moment in local directions. Strain: ϵ_x , ϵ_y , ψ_z : spring strains in local directions.
Modeller	See Results Tables (Appendix K) .

Local Axes

- [Standard joint element](#)

Sign Convention

- [Standard joint element](#)

Formulation

Geometric Nonlinearity

Not applicable.

Integration Schemes

Stiffness	Default.	1-point.
	Fine.	As default.
Mass	Default.	1-point.
	Fine.	As default.

Mass Modelling

Lumped mass only. The position of the mass relative to the two active joint nodes is defined in the joint material data. Point mass elements should be used to model lumped masses when no stiffness modelling is required.

Options

- 55 Output strains as well as stresses.
- 119 Invokes temperature input for joints.

Notes on Use

See [Joint Element Compatibility and Notes \(Appendix L\)](#).

Restrictions

Not applicable.

Recommendations on Use

- The joint elements may be used to release degrees of freedom between elements, e.g. a hinged shell, or to provide nonlinear support conditions, e.g. friction-gap condition. Also, point masses may be represented by including a joint at an element node.
- See [Joint Element Compatibility \(Appendix L\)](#)

2D Joint Element for Grillage Beams and Plates

General

Element Name JF3

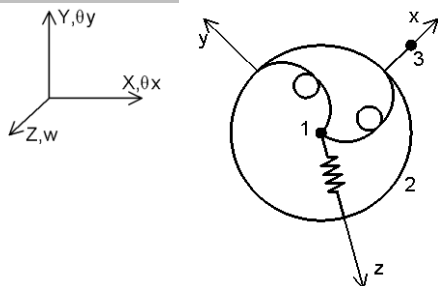

Element Group	Joints
Element Subgroup	2D Joints
Element Description	A 2D joint element which connects two nodes by one spring in the local z-direction and two springs about the x and y directions.
Number Of Nodes	3. The 3rd node is used to define the local x-direction.
Freedom Node	W, θ_x , θ_y : at nodes 1 and 2 (active nodes).
Coordinates	X, Y: at each node.

Geometric Properties

dz Parametric distance factor (between 0.0 and 1.0), which defines the position of the shear spring for the local z direction between nodes 1 and 2. It is measured from node 1 ($dz=0$) along the local x direction.

Material Properties

Linear Not applicable

Matrix Stiffness: MATRIX PROPERTIES STIFFNESS 6
K1,..., K21 element stiffness matrix (Not supported in LUSAS Modeller)

Mass: MATRIX PROPERTIES MASS 6 M1,..., M21 element mass matrix (Not supported in LUSAS Modeller)

Damping: MATRIX PROPERTIES DAMPING 6
C1,..., C21 element damping matrix (Not supported in LUSAS Modeller)

Joint	Standard:	JOINT PROPERTIES 3 (Joint: 3/Spring Stiffness Only)
	Dynamic general:	JOINT PROPERTIES GENERAL 3 (Joint: 3/General Properties)
	Elasto-plastic:	JOINT PROPERTIES NONLINEAR 31 3 (Joint: 3/Elasto-Plastic (Tension and Compression Equal))
	Elasto-plastic:	JOINT PROPERTIES NONLINEAR 32 3 (Joint: 3/Tension and Compression Unequal)
	Nonlinear contact:	JOINT PROPERTIES NONLINEAR 33 3 (Joint: 3/Smooth Contact)
	Nonlinear friction:	Not applicable
	Viscous damping:	JOINT PROPERTIES NONLINEAR 35 3 (Joint: 3/Viscous Damper)
	Lead-rubber:	Not applicable
	Friction pendulum:	Not applicable
	Multi-linear elastic	JOINT PROPERTIES NONLINEAR 40 3 (Joint: 3/Multi-Linear Elastic)
	Multi-linear hysteresis	JOINT PROPERTIES NONLINEAR 41 3 (Joint: 3/Multi-Linear Hysteresis)
	Multi-linear compound hysteresis	JOINT PROPERTIES NONLINEAR 42 3 (Joint: 3/Multi-Linear Compound Hysteresis)
	Axial force dependent multi-linear elastic	JOINT PROPERTIES NONLINEAR 43 3 (Joint: 3/Axial Force Dependent Multi-Linear Elastic)
Concrete		Not applicable
Elasto-Plastic		Not applicable
Creep		Not applicable
Damage		Not applicable
Viscoelastic		Not applicable.
Shrinkage		Not applicable
Rubber		Not applicable
Generic Polymer		Not applicable
Composite		Not applicable

Loading

Prescribed Value	PDSP, TPDSP	Prescribed variable. ω , θ_x , θ_y : at active
-------------------------	-------------	---

		nodes.
Concentrated Loads	CL	Concentrated loads. Pz, Mx, My: at active nodes.
Element Loads	Not applicable	
Distributed Loads	Not applicable	
Body Forces	CBF BFP, BFPE	Constant body forces for element. Zcbf Not applicable.
Velocities	VELO	Velocities. Vz: at nodes.
Accelerations	ACCE	Accelerations. Az: at nodes.
Viscous Support Loads	VSL	Viscous support loads. VLz: at nodes.
Initial Stress/Strains	SSI, SSIE	Initial stresses/strains at nodes/for element. Fz, Mx, My: at active nodes. $\epsilon_z, \psi_x, \psi_y$: at active nodes.
	SSIG	Not applicable.
Residual Stresses	Not applicable	
Target Stress/Strains	TSSIE, TSSIA	Target stresses/strains at nodes/for element. Fz, Mx, My: at active nodes. $\epsilon_z, \psi_x, \psi_y$: at active nodes.
	TSSIG	Not applicable.
Temperatures	TEMP, TMPE	Temperatures at nodes/for element. T1, T2, T3, T10, T20, T30: actual and initial spring temperatures.
Overburden	Not applicable.	
Phreatic Surface	Not applicable.	
Field Loads	Not applicable	
Temp Dependent Loads	Not applicable	

LUSAS Output

Solver	Force: Pz, Mx, My: spring forces in local directions. Strain: $\epsilon_z, \psi_x, \psi_y$: spring strains in local directions.
Modeller	See Results Tables (Appendix K) .

Local Axes

- [Standard joint element](#)

Sign Convention

- [Standard joint element](#)

Formulation

Geometric Nonlinearity

Not applicable.

Integration Schemes

Stiffness	Default.	1-point.
	Fine.	As default.
Mass	Default.	1-point.
	Fine.	As default.

Mass Modelling

Lumped mass only. The position of the mass relative to the two active joint nodes is defined in the joint material data. Point mass elements should be used to model lumped masses when no stiffness modelling is required.

Options

- 55 Output strains as well as stresses.
- 119 Invokes temperature input for joints.

Notes on Use

See [Joint Element Compatibility and Notes \(Appendix L\)](#).

Restrictions

Not applicable.

Recommendations on Use

- The joint elements may be used to release degrees of freedom between elements, e.g. a hinged shell, or to provide nonlinear support conditions, e.g. friction-gap condition. Also, point masses may be represented by including a joint at an element node.
- See [Joint Element Compatibility \(Appendix L\)](#)

2D Joint Element for Axisymmetric Solids

General

Element Name JAX3

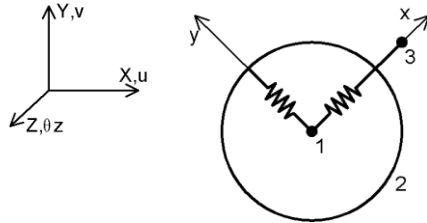

Element Group	Joints
Element Subgroup	2D Joints
Element Description	An axisymmetric joint element for use with axisymmetric solid elements, which connects two nodes by two springs in the local x and y-directions and a 3rd spring in the circumferential direction.
Number Of Nodes	3. The 3rd node is used to define the local x-direction.
Freedom Node	U, V: at nodes 1 and 2 (active nodes).
Coordinates	X, Y: at each node.

Geometric Properties

Not applicable.

Material Properties

Linear Matrix	Not applicable	
	Stiffness:	MATRIX PROPERTIES STIFFNESS 6 K1,..., K10 element stiffness matrix (Not supported in LUSAS Modeller)
	Mass:	MATRIX PROPERTIES MASS 6 M1,..., M10 element mass matrix (Not supported in LUSAS Modeller)
	Damping:	MATRIX PROPERTIES DAMPING 6 C1,..., C10 element damping matrix (Not supported in LUSAS Modeller)
Joint	Standard:	JOINT PROPERTIES 2 (Joint: 2/Spring Stiffness Only) (See notes on use)
	Dynamic general:	JOINT PROPERTIES GENERAL 2 (Joint:

		2/General Properties) (See notes on use)
Elasto-plastic:	JOINT PROPERTIES NONLINEAR 31 2	(Joint: 2/Elasto-Plastic (Tension and Compression Equal)) (See notes on use)
Elasto-plastic:	JOINT PROPERTIES NONLINEAR 32 2	(Joint: 2/Tension and Compression Unequal) (See notes on use)
Nonlinear contact:	JOINT PROPERTIES NONLINEAR 33 2	(Joint: 2/Smooth Contact) (See notes on use)
Nonlinear friction:	JOINT PROPERTIES NONLINEAR 44 2	(Joint: 2/Frictional Contact) (See notes on use)
Viscous damping:	JOINT PROPERTIES NONLINEAR 35 2	(Joint: 2/Viscous Damper) (See notes on use)
Lead-rubber:	JOINT PROPERTIES NONLINEAR 36 2	(Joint: 2/Lead Rubber Bearing) (See notes on use)
Friction pendulum:	JOINT PROPERTIES NONLINEAR 37 2	(Joint: 2/Frictional Pendulum System) (See notes on use)
Multi-linear elastic	JOINT PROPERTIES NONLINEAR 40 2	(Joint: 2/Multi-Linear Elastic)
Multi-linear hysteresis	JOINT PROPERTIES NONLINEAR 41 2	(Joint: 2/Multi-Linear Hysteresis)
Multi-linear compound hysteresis	JOINT PROPERTIES NONLINEAR 42 2	(Joint: 2/Multi-Linear Compound Hysteresis)
Axial force dependent multi-linear elastic	JOINT PROPERTIES NONLINEAR 43 2	(Joint: 2/Axial Force Dependent Multi-Linear Elastic)
Concrete	Not applicable	
Elasto-Plastic	Not applicable	
Creep	Not applicable	
Damage	Not applicable	
Viscoelastic	Not applicable	
Shrinkage	Not applicable	
Rubber	Not applicable	
Generic Polymer	Not applicable	
Composite	Not applicable	

Loading

Prescribed Value	PDSP, TPDSP	Prescribed variable. U, V: at active nodes.
Concentrated Loads	CL	Concentrated loads. Px, Py: at active nodes.
Element Loads	Not applicable.	
Distributed Loads	Not applicable.	
Body Forces	CBF	Constant body forces for element. Xcbf, Ycbf, $\Omega_x, \Omega_y, \Omega_z, \Omega_z$
	BFP, BFPE	Not applicable.
Velocities	VELO	Velocities. Vx, Vy: at nodes.
Accelerations	ACCE	Accelerations. Ax, Ay: at nodes..
Viscous Support Loads	VSL	Viscous support loads. VLx, VLy: at nodes.
Initial Stress/Strains	SSI, SSIE	Initial stresses/strains at nodes/for element. Fx, Fy: spring forces in local directions. ϵ_x, ϵ_y : spring strains in local directions.
	SSIG	Not applicable.
Residual Stresses	Not applicable.	
Target Stress/Strains	TSSIE, TSSIA	Target stresses/strains at nodes/for element. Fx, Fy: spring forces in local directions. ϵ_x, ϵ_y : spring strains in local directions.
	TSSIG	Not applicable.
Temperatures	TEMP, TMPE	Temperatures at nodes/for element. T1, T2, T10, T20: actual and initial spring temperatures.
Overburden	Not applicable.	
Phreatic Surface	Not applicable.	
Field Loads	Not applicable.	
Temp Dependent Loads	Not applicable.	

LUSAS Output

Solver	Force: Fx, Fy, Fz: spring forces in local directions. Strain: $\epsilon_x, \epsilon_y, \epsilon_z$: spring strains in local directions.
---------------	---

Modeller See [Results Tables \(Appendix K\)](#).

Local Axes

- [Standard joint element](#)

Sign Convention

- [Standard joint element](#)

Formulation

Geometric Nonlinearity

Not applicable.

Integration Schemes

Stiffness	Default.	1-point.
	Fine.	As default.
Mass	Default.	1-point.
	Fine.	As default.

Mass Modelling

Lumped mass only. The position of the mass relative to the two active joint nodes is defined in the joint material data. Point mass elements should be used to model lumped masses when no stiffness modelling is required.

Options

- 47 X-axis taken as axis of symmetry.
- 55 Output strains as well as stresses.
- 119 Invokes temperature input for joints.

Notes on Use

- This joint has only two degrees of freedom but requires 3 inputs. The 3rd input required is the circumferential stiffness.
- For problems where the circumferential forces are to be transmitted by adjacent elements the circumferential stiffness should be input as zero.
- This element cannot be used with axisymmetric Fourier elements.

See [Joint Element Compatibility and Notes \(Appendix L\)](#).

Restrictions

Not applicable.

Recommendations on Use

- The joint elements may be used to release degrees of freedom between elements, e.g. a hinged shell, or to provide nonlinear support conditions, e.g. friction-gap condition. Also, point masses may be represented by including a joint at an element node.
- See [Joint Element Compatibility \(Appendix L\)](#)

2D Joint Element for Axisymmetric Shells

General

Element Name

JXS3

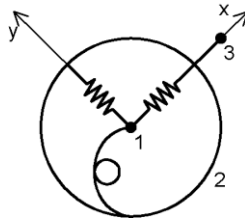
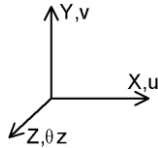

Element Group

Joints

Element

2D Joints

Subgroup

Element Description

An axisymmetric joint element for use with axisymmetric shell elements, which connects two nodes by two springs in the local x and y-directions, one spring about the local z-direction and a 4th spring in the circumferential direction.

Number Of Nodes

3. The 3rd node is used to define the local x-direction.

Freedom

U, V, θ : at nodes 1 and 2 (active nodes).

Node Coordinates

X, Y: at each node.

Geometric Properties

dy Parametric distance factor (between 0.0 and 1.0), which defines the position of the shear spring for the local y direction between nodes 1 and 2. It is measured from node 1 ($dy=0$) along the local x direction.

Material Properties

Linear Not applicable

Matrix Stiffness:

MATRIX PROPERTIES STIFFNESS 8 K1,..., K21 element stiffness matrix (Not supported in LUSAS Modeller)

Mass:

MATRIX PROPERTIES MASS 8 M1,..., M21 element mass matrix (Not supported in LUSAS Modeller)

Damping:

MATRIX PROPERTIES DAMPING 8 C1,..., C21 element damping matrix (Not supported)

		in LUSAS Modeller)
Joint	Standard:	JOINT PROPERTIES 3 (Joint: 3/Spring Stiffness Only) (See notes on use)
	Dynamic general:	JOINT PROPERTIES GENERAL 3 (Joint: 3/General Properties) (See notes on use)
	Elasto-plastic:	JOINT PROPERTIES NONLINEAR 31 3 (Joint: 3/Elasto-Plastic (Tension and Compression Equal)) (See notes on use)
	Elasto-plastic:	JOINT PROPERTIES NONLINEAR 32 3 (Joint: 3/Tension and Compression Unequal) (See notes on use)
	Nonlinear contact:	JOINT PROPERTIES NONLINEAR 33 3 (Joint: 3/Smooth Contact) (See notes on use)
	Nonlinear friction:	JOINT PROPERTIES NONLINEAR 44 3 (Joint: 3/Frictional Contact) (See notes on use)
	Viscous damping:	JOINT PROPERTIES NONLINEAR 35 3 (Joint: 3/Viscous Damper) (See notes on use)
	Lead-rubber:	JOINT PROPERTIES NONLINEAR 36 3 (Joint:3/Lead Rubber Bearing) (See notes on use)
	Friction pendulum:	JOINT PROPERTIES NONLINEAR 37 3 (Joint: 3/Frictional Pendulum System) (See notes on use)
	Multi-linear elastic	JOINT PROPERTIES NONLINEAR 40 3 (Joint: 3/Multi-Linear Elastic)
	Multi-linear hysteresis	JOINT PROPERTIES NONLINEAR 41 3 (Joint: 3/Multi-Linear Hysteresis)
	Multi-linear compound hysteresis	JOINT PROPERTIES NONLINEAR 42 3 (Joint: 3/Multi-Linear Compound Hysteresis)
	Axial force dependent multi-linear elastic	JOINT PROPERTIES NONLINEAR 43 3 (Joint: 3/Axial Force Dependent Multi-Linear Elastic)
Concrete	Not applicable	
Elasto-Plastic	Not applicable	
Creep	Not applicable	
Damage	Not applicable	
Viscoelastic	Not applicable	
Shrinkage	Not applicable	
Rubber	Not applicable	
Generic Polymer	Not applicable	

Composite Not applicable

Loading

Prescribed Value	PDSP, TPDSP	Prescribed variable. U, V, θ : at active nodes.
Concentrated Loads	CL	Concentrated loads. Px, Py, M: at active nodes.
Element Loads	Not applicable.	
Distributed Loads	Not applicable.	
Body Forces	CBF	Constant body forces for element. Xcbf, Ycbf, $\Omega_x, \Omega_y, \Omega_z, \alpha_z$
	BFP, BFPE	Not applicable.
Velocities	VELO	Velocities. Vx, Vy: at nodes.
Accelerations	ACCE	Accelerations. Ax, Ay: at nodes.
Viscous Support Loads	VSL	Viscous support loads. VLx, VLy: at nodes.
Initial Stress/Strains	SSI, SSIE	Initial stresses/strains at nodes/for element. Fx, Fy: spring forces in local directions. ϵ_x, ϵ_y : spring strains in local directions.
	SSIG	Not applicable.
Residual Stresses	Not applicable.	
Target Stress/Strains	TSSIE, TSSIA	Target stresses/strains at nodes/for element. Fx, Fy: spring forces in local directions. ϵ_x, ϵ_y : spring strains in local directions.
	TSSIG	Not applicable.
Temperatures	TEMP, TMPE	Temperatures at nodes/for element. T1, T2, T3, T10, T20, T30: actual and initial spring temperatures.
Overburden	Not applicable.	
Phreatic Surface	Not applicable.	
Field Loads	Not applicable.	
Temp Dependent Loads	Not applicable.	

LUSAS Output

Solver	Force: F_x, F_y, F_z, M : spring forces in local directions. Strain: $\epsilon_x, \epsilon_y, \epsilon_z, \psi_z$: spring strains in local directions.
Modeller	See Results Tables (Appendix K) .

Local Axes

- [Standard joint element](#)

Sign Convention

- [Standard joint element](#)

Formulation

Geometric Nonlinearity

Not applicable.

Integration Schemes

Stiffness	Default.	1-point.
	Fine.	As default.
Mass	Default.	1-point.
	Fine.	As default.

Mass Modelling

Lumped mass only. The position of the mass relative to the two active joint nodes is defined in the joint material data. Point mass elements should be used to model lumped masses when no stiffness modelling is required.

Options

47	X-axis taken as axis of symmetry.
55	Output strains as well as stresses.
119	Invokes temperature input for joints.

Notes on Use

This joint has only three degrees of freedom but requires 4 inputs. The 4th input required is the circumferential stiffness.

See [Joint Element Compatibility and Notes \(Appendix L\)](#).

Restrictions

Not applicable.

Recommendations on Use

- The joint elements may be used to release degrees of freedom between elements, e.g. a hinged shell, or to provide nonlinear support conditions, e.g. friction-gap condition. Also, point masses may be represented by including a joint at an element node.
- See [Joint Element Compatibility \(Appendix L\)](#)

3D Joints for Bars, Solids and Space Membranes

General

Element Name JNT4

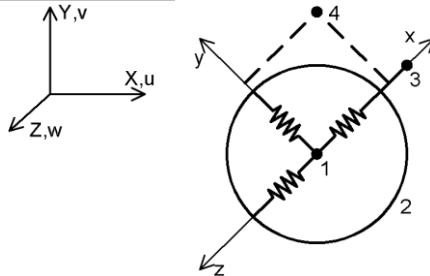

Element Group	Joints
Element Subgroup	3D Joints
Element Description	A 3D joint element which connects two nodes by three springs in the local x, y and z-directions.
Number Of Nodes	4. The 3rd and 4th nodes are used to define the local x-axis and local xy-plane.
Freedom Node Coordinates	U, V, W: at nodes 1 and 2 (active nodes). X, Y, Z: at each node.

Geometric Properties

Not applicable.

Material Properties

Linear	Not applicable
Matrix	Stiffness: MATRIX PROPERTIES STIFFNESS 6 K1,..., K21 element stiffness matrix (Not supported in LUSAS Modeller)
	Mass: MATRIX PROPERTIES MASS 6 M1,..., M21 element mass matrix (Not supported in LUSAS Modeller)
	Damping: MATRIX PROPERTIES DAMPING 6 C1,..., C21 element damping matrix (Not supported in LUSAS Modeller)
Joint	Standard: JOINT PROPERTIES 3 (Joint: 3/Spring)

		Stiffness Only)
Dynamic general:	JOINT PROPERTIES GENERAL 3 (Joint: 3/General Properties)	
Elasto-plastic:	JOINT PROPERTIES NONLINEAR 31 3 (Joint: 3/Elasto-Plastic (Tension and Compression Equal))	
Elasto-plastic:	JOINT PROPERTIES NONLINEAR 32 3 (Joint: 3/Tension and Compression Unequal)	
Nonlinear contact:	JOINT PROPERTIES NONLINEAR 33 3 (Joint: 3/Smooth Contact)	
Nonlinear friction:	JOINT PROPERTIES NONLINEAR 44 3 (Joint: 3/Frictional Contact)	
Viscous damping:	JOINT PROPERTIES NONLINEAR 35 3 (Joint: 3/Viscous Damper)	
Lead-rubber:	JOINT PROPERTIES NONLINEAR 36 3 (Joint: 3/Lead Rubber Bearing)	
Friction pendulum:	JOINT PROPERTIES NONLINEAR 37 3 (Joint: 3/Frictional Pendulum System)	
Multi-linear elastic	JOINT PROPERTIES NONLINEAR 40 3 (Joint: 3/Multi-Linear Elastic)	
Multi-linear hysteresis	JOINT PROPERTIES NONLINEAR 41 3 (Joint: 3/Multi-Linear Hysteresis)	
Multi-linear compound hysteresis	JOINT PROPERTIES NONLINEAR 42 3 (Joint: 3/Multi-Linear Compound Hysteresis)	
Axial force dependent multi-linear elastic	JOINT PROPERTIES NONLINEAR 43 3 (Joint: 3/Axial Force Dependent Multi-Linear Elastic)	
Concrete	Not applicable	
Elasto-Plastic	Not applicable	
Creep	Not applicable	
Damage	Not applicable	
Viscoelastic	Not applicable	
Shrinkage	Not applicable	
Rubber	Not applicable	
Generic Polymer	Not applicable	
Composite	Not applicable	

Loading

Prescribed Value	PDSP, TPDSP	Prescribed variable. U, V, W: at active nodes.
Concentrated	CL	Concentrated loads. Px, Py, Pz: at active nodes.

Loads		
Element Loads	Not applicable.	
Distributed Loads	Not applicable.	
Body Forces	CBF	Constant body forces for element. Xcbf, Ycbf, Zcbf, Ω_x , Ω_y , Ω_z , α_x , α_y , α_z
	BFP, BFPE	Not applicable.
Velocities	VELO	Velocities. Vx, Vy, Vz: at nodes.
Accelerations	ACCE	Accelerations. Ax, Ay, Az: at nodes.
Viscous Support Loads	VSL	Viscous support loads. VLx, VLy, VLz: at nodes.
Initial Stress/Strains	SSI, SSIE	Initial stresses/strains at nodes/for element. Fx, Fy, Fz: spring forces in local directions. ϵ_x , ϵ_y , ψ_z : spring strains in local directions.
	SSIG	Not applicable.
Residual Stresses	Not applicable.	
Target Stress/Strains	TSSIE, TSSIA	Target initial stresses/strains at nodes/for element. Fx, Fy, Fz: spring forces in local directions. ϵ_x , ϵ_y , ψ_z : spring strains in local directions.
	TSSIG	Not applicable.
Temperatures	TEMP, TMPE	Temperatures at nodes/for element. T1, T2, T3, T10, T20, T30: actual and initial spring temperatures.
Overburden	Not applicable.	
Phreatic Surface	Not applicable.	
Field Loads	Not applicable.	
Temp Dependent Loads	Not applicable.	

LUSAS Output

Solver	Force: Fx, Fy, Fz: spring forces in local directions. Strain: ϵ_x , ϵ_y , ϵ_z : spring strains in local directions.
Modeller	See Results Tables (Appendix K) .

Local Axes

- [Standard joint element](#)

Sign Convention

- [Standard joint element](#)

Formulation

Geometric Nonlinearity

Not applicable.

Integration Schemes

Stiffness Default.	1-point.
Fine.	As default.
Mass Default.	1-point.
Fine	As default.

Mass Modelling

Lumped mass only. The position of the mass relative to the two active joint nodes is defined in the joint material data. Point mass elements should be used to model lumped masses when no stiffness modelling is required.

Options

- 55 Output strains as well as stresses.
- 119 Invokes temperature input for joints.

Notes on Use

See [Joint Element Compatibility and Notes \(Appendix L\)](#).

Restrictions

Not applicable.

Recommendations on Use

- The joint elements may be used to release degrees of freedom between elements, e.g. a hinged shell, or to provide nonlinear support conditions, e.g. friction-gap condition. Also, point masses may be represented by including a joint at an element node.

- See [Joint Element Compatibility \(Appendix L\)](#)

3D Joints for Semiloof Shells

General

Element Name JL43

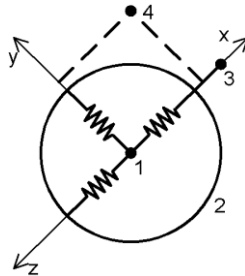
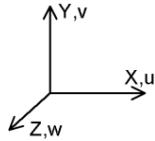

Element Group

Joints

Element

3D Joints

Subgroup

Element Description

A 3D joint element which connects two nodes by three springs in the local x, y and z-directions.

Number Of Nodes

4. The 3rd and 4th nodes are used to define the local x-axis and local xy-plane.

Freedom

U, V, W: at nodes 1 and 2 (active nodes).

Node

X, Y, Z: at each node.

Coordinates

Geometric Properties

Not applicable.

Material Properties

Linear Not applicable

Matrix Stiffness:

MATRIX PROPERTIES STIFFNESS 6
K1,..., K21 element stiffness matrix (Not supported in LUSAS Modeller)

Mass:

MATRIX PROPERTIES MASS 6 M1,..., M21 element mass matrix (Not supported in LUSAS Modeller)

Damping:

MATRIX PROPERTIES DAMPING 6
C1,..., C21 element damping matrix (Not supported in LUSAS Modeller)

Joint Standard:

JOINT PROPERTIES 3 (Joint: 3/Spring Stiffness Only)

Dynamic general:

JOINT PROPERTIES GENERAL 3 (Joint:

		3/General Properties)
Elasto-plastic:		JOINT PROPERTIES NONLINEAR 31 3 (Joint: 3/Elasto-Plastic (Tension and Compression Equal))
Elasto-plastic:		JOINT PROPERTIES NONLINEAR 32 3 (Joint: 3/Tension and Compression Unequal)
Nonlinear contact:		JOINT PROPERTIES NONLINEAR 33 3 (Joint: 3/Smooth Contact)
Nonlinear friction:		JOINT PROPERTIES NONLINEAR 44 3 (Joint: 3/Frictional Contact)
Viscous damping:		JOINT PROPERTIES NONLINEAR 35 3 (Joint: 3/Viscous Damper)
Lead-rubber:		JOINT PROPERTIES NONLINEAR 36 3 (Joint: 3/Lead Rubber Bearing)
Friction pendulum:		JOINT PROPERTIES NONLINEAR 37 3 (Joint: 3/Frictional Pendulum System)
Multi-linear elastic		JOINT PROPERTIES NONLINEAR 40 3 (Joint: 3/Multi-Linear Elastic)
Multi-linear hysteresis		JOINT PROPERTIES NONLINEAR 41 3 (Joint: 3/Multi-Linear Hysteresis)
Multi-linear compound hysteresis		JOINT PROPERTIES NONLINEAR 42 3 (Joint: 3/Multi-Linear Compound Hysteresis)
Axial force dependent multi- linear elastic		JOINT PROPERTIES NONLINEAR 43 3 (Joint: 3/Axial Force Dependent Multi- Linear Elastic)
Concrete	Not applicable	
Elasto-Plastic	Not applicable	
Creep	Not applicable	
Damage	Not applicable	
Viscoelastic	Not applicable	
Shrinkage	Not applicable	
Rubber	Not applicable	
Generic Polymer	Not applicable	
Composite	Not applicable	

Loading

Prescribed Value	PDSP, TPDSP	Prescribed variable. U, V, W: at active nodes.
Concentrated Loads	CL	Concentrated loads. Px, Py, Pz: at active nodes.
Element Loads	Not	

		applicable.
Distributed Loads		Not applicable.
Body Forces	CBF	Constant body forces for element. X_{cbf} , Y_{cbf} , Z_{cbf} , Ω_x , Ω_y , Ω_z , α_x , α_y , α_z
	BFP, BFPE	Not applicable.
Velocities	VELO	Velocities. V_x , V_y , V_z : at nodes.
Accelerations	ACCE	Accelerations. A_x , A_y , A_z : at nodes.
Viscous Support Loads	VSL	Viscous support loads. VL_x , VL_y , VL_z : at nodes.
Initial Stress/Strains	SSI, SSIE	Initial stresses/strains at nodes/for element. F_x , F_y , F_z : spring forces in local directions. ϵ_x , ϵ_y , ψ_z : spring strains in local directions.
	SSIG	Not applicable.
Residual Stresses		Not applicable.
Target Stress/Strains	TSSIE, TSSIA	Target stresses/strains at nodes/for element. F_x , F_y , F_z : spring forces in local directions. ϵ_x , ϵ_y , ψ_z : spring strains in local directions.
	TSSIG	Not applicable.
Temperatures	TEMP, TMPE	Temperatures at nodes/for element. T_1 , T_2 , T_3 , T_{10} , T_{20} , T_{30} : actual and initial spring temperatures.
Overburden		Not applicable.
Phreatic Surface		Not applicable.
Field Loads		Not applicable.
Temp Dependent Loads		Not applicable.

LUSAS Output

Solver	Force: F_x , F_y , F_z : spring forces in local directions. Strain: ϵ_x , ϵ_y , ϵ_z : spring strains in local directions.
Modeller	See Results Tables (Appendix K) .

Local Axes

- Standard joint element

Sign Convention

- [Standard joint element](#)

Formulation

Geometric Nonlinearity

Not applicable.

Integration Schemes

Stiffness	Default.	1-point.
	Fine.	As default.
Mass	Default.	1-point.
	Fine.	As default.

Mass Modelling

Lumped mass only. The position of the mass relative to the two active joint nodes is defined in the joint material data. Point mass elements should be used to model lumped masses when no stiffness modelling is required.

Options

- 55 Output strains as well as stresses.
- 119 Invokes temperature input for joints.

Notes on Use

- When using Modeller to assign this semiloof joint element to interface lines a JL43 joint element will be created at the semiloof shell corner nodes and a JSL4 joint element will be created at the semiloof shell mid-side nodes.

See [Joint Element Compatibility and Notes \(Appendix L\)](#).

Restrictions

Not applicable.

Recommendations on Use

- The joint elements may be used to release degrees of freedom between elements, e.g. a hinged shell, or to provide nonlinear support conditions, e.g.

friction-gap condition. Also, point masses may be represented by including a joint at an element node.

- See [Joint Element Compatibility \(Appendix L\)](#)

3D Joint Elements for Engineering, Kirchhoff and Semiloof Beams

General

Element Name

JSH4, JL46

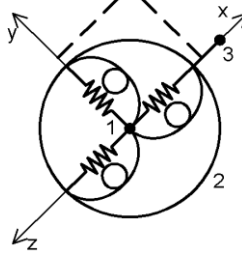
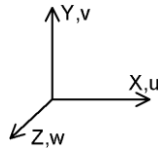

Element Group

Joints

Element

3D Joints

Subgroup

Element
Description

3D joint elements which connects two nodes by six springs in the local x, y and z-directions. Use JL46 for semiloof beam end nodes.

Number Of
Nodes

4. The 3rd and 4th nodes are used to define the local x-axis and local xy-plane respectively.

Freedom

U, V, W, θ_x , θ_y , θ_z : at nodes 1 and 2 (active nodes).

Node

X, Y, Z: at each node.

Coordinates

Geometric Properties

- ez** Eccentricity measured from the joint xy-plane to the nodal line.
- dy** Parametric distance factor (between 0.0 and 1.0), which defines the position of the shear spring for the local y direction between nodes 1 and 2. It is measured from node 1 ($dy=0$) along the local x direction.
- dz** Parametric distance factor (between 0.0 and 1.0), which defines the position of the shear spring for the local z direction between nodes 1 and 2. It is measured from node 1 ($dz=0$) along the local x direction.

Material Properties

Linear Not applicable

Matrix Stiffness:

MATRIX PROPERTIES STIFFNESS 12
K1,..., K78 element stiffness matrix (Not supported in LUSAS Modeller)

Mass:

MATRIX PROPERTIES MASS 12 M1,...,

		M78 element mass matrix (Not supported in LUSAS Modeller)
	Damping:	MATRIX PROPERTIES DAMPING 12 C1,..., C78 element damping matrix (Not supported in LUSAS Modeller)
Joint	Standard:	JOINT PROPERTIES 6 (Joint: 6/Spring Stiffness Only)
	Dynamic general:	JOINT PROPERTIES GENERAL 6 (Joint: 6/General Properties)
	Elasto-plastic:	JOINT PROPERTIES NONLINEAR 31 6 (Joint: 6/Elasto-Plastic (Tension and Compression Equal))
	Elasto-plastic:	JOINT PROPERTIES NONLINEAR 32 6 (Joint: 6/Tension and Compression Unequal)
	Nonlinear contact:	JOINT PROPERTIES NONLINEAR 33 6 (Joint: 6/Smooth Contact)
	Nonlinear friction:	JOINT PROPERTIES NONLINEAR 44 6 (Joint: 6/Frictional Contact)
	Viscous damping:	JOINT PROPERTIES NONLINEAR 35 6 (Joint: 6/Viscous Damper)
	Lead-rubber:	JOINT PROPERTIES NONLINEAR 36 6 (Joint: 6/Lead Rubber Bearing)
	Friction pendulum:	JOINT PROPERTIES NONLINEAR 37 6 (Joint: 6/Frictional Pendulum System)
	Multi-linear elastic	JOINT PROPERTIES NONLINEAR 40 6 (Joint: 6/Multi-Linear Elastic)
	Multi-linear hysteresis	JOINT PROPERTIES NONLINEAR 41 6 (Joint: 6/Multi-Linear Hysteresis)
	Multi-linear compound hysteresis	JOINT PROPERTIES NONLINEAR 42 6 (Joint: 6/Multi-Linear Compound Hysteresis)
	Axial force dependent multi-linear elastic	JOINT PROPERTIES NONLINEAR 43 6 (Joint: 6/Axial Force Dependent Multi-Linear Elastic)
Concrete	Not applicable	
Elasto-Plastic	Not applicable	
Creep	Not applicable	
Damage	Not applicable	
Viscoelastic	Not applicable	
Shrinkage	Not applicable	
Rubber	Not applicable	
Generic Polymer	Not applicable	

Composite Not applicable

Loading

Prescribed Value	PDSP, TPDSP	Prescribed variable. U, V, W, θ_x , θ_y , θ_z : at active nodes.
Concentrated Loads	CL	Concentrated loads. Px, Py, Pz, Mx, My, Mz: at active nodes.
Element Loads	Not applicable.	
Distributed Loads	Not applicable.	
Body Forces	CBF	Constant body forces for element. Xcbf, Ycbf, Zcbf, Ω_x , Ω_y , Ω_z , α_x , α_y , α_z
	BFP, BFPE	Not applicable.
Velocities	VELO	Velocities. Vx, Vy, Vz: at nodes.
Accelerations	ACCE	Accelerations. Ax, Ay, Az: at nodes.
Viscous Support Loads	VSL	Viscous support loads. VLx, VLy, VLz: at nodes.
Initial Stress/Strains	SSI, SSIE	Initial stresses/strains at nodes/for element. Fx, Fy, Fz, Mx, My, Mz: spring forces in local directions. ϵ_x , ϵ_y , ϵ_z , ψ_x , ψ_y , ψ_z : spring strains in local directions.
	SSIG	Not applicable.
Residual Stresses	Not applicable.	
Target Stress/Strains	TSSIE, TSSIA	Target stresses/strains at nodes/for element. Fx, Fy, Fz, Mx, My, Mz: spring forces in local directions. ϵ_x , ϵ_y , ϵ_z , ψ_x , ψ_y , ψ_z : spring strains in local directions.
	TSSIG	Not applicable.
Temperatures	TEMP, TMPE	Temperatures at nodes/for element. T1, T2, T3, T4, T5, T6, T10, T20, T30, T40, T50, T60: actual and initial spring temperatures.
Overburden	Not applicable.	
Phreatic Surface	Not applicable.	
Field Loads	Not applicable.	
Temp Dependent Loads	Not applicable.	

LUSAS Output

Solver Force: Fx, Fy, Fz, Mx, My, Mz spring forces in local directions.
 Strain: ϵ_x , ϵ_y , ϵ_z , ψ_x , ψ_y , ψ_z : spring strains in local directions.

Modeller See [Results Tables \(Appendix K\)](#).

Local Axes

- [Standard joint element](#)

Sign Convention

- [Standard joint element](#)

Formulation

Geometric Nonlinearity

Not applicable.

Integration Schemes

Stiffness	Default.	1-point.
	Fine.	As default.
Mass	Default.	1-point.
	Fine	As default.

Mass Modelling

Lumped mass only. The position of the mass relative to the two active joint nodes is defined in the joint material data. Point mass elements should be used to model lumped masses when no stiffness modelling is required.

Options

- 55 Output strains as well as stresses.
- 119 Invokes temperature input for joints

Notes on Use

See [Joint Element Compatibility and Notes](#).

Restrictions

Not applicable.

Recommendations on Use

- The joint elements may be used to release degrees of freedom between elements, e.g. a hinged shell, or to provide nonlinear support conditions, e.g.

friction-gap condition. Also, point masses may be represented by including a joint at an element node.

- See [Joint Element Compatibility \(Appendix L\)](#)

3D Joint Element for Semiloof Beams

General

Element Name

JSL4

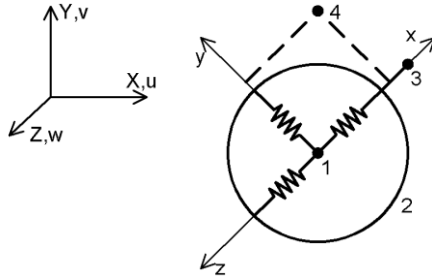

Element Group

Joints

Element

3D Joints

Subgroup

Element Description

A 3D joint element which connects two nodes by three springs in the local x, y and z-directions and two springs about the local x-direction at the 1st and 2nd loof points.

Number Of Nodes

4. The 3rd and 4th nodes are used to define the local x-axis and local xy-plane respectively.

Freedom

U, V, W, θ_1 , θ_2 : at nodes 1 and 2 (active nodes).

Node Coordinates

X, Y, Z: at each node.

Geometric Properties

Not applicable.

Material Properties

Linear Not applicable

Matrix Stiffness:

MATRIX PROPERTIES STIFFNESS 10
K1,..., K55 element stiffness matrix (Not supported in LUSAS Modeller)

Mass:

MATRIX PROPERTIES MASS 10 M1,..., M55 element mass matrix (Not supported in LUSAS Modeller)

Damping:

MATRIX PROPERTIES DAMPING 10
C1,..., C55 element damping matrix (Not supported in LUSAS Modeller)

Joint Standard:

JOINT PROPERTIES 5 (Joint: 5/Spring)

		Stiffness Only)
Dynamic general:	JOINT PROPERTIES GENERAL 5 (Joint: 5/General Properties)	
Elasto-plastic:	JOINT PROPERTIES NONLINEAR 31 5 (Joint: 5/Elasto-Plastic (Tension and Compression Equal))	
Elasto-plastic:	JOINT PROPERTIES NONLINEAR 32 5 (Joint:5/Tension and Compression Unequal)	
Nonlinear contact:	JOINT PROPERTIES NONLINEAR 33 5 (Joint: 5/Smooth Contact)	
Nonlinear friction:	JOINT PROPERTIES NONLINEAR 44 5 (Joint: 5/Frictional Contact)	
Viscous damping:	JOINT PROPERTIES NONLINEAR 35 5 (Joint: 5/Viscous Damper)	
Lead-rubber:	JOINT PROPERTIES NONLINEAR 36 5 (Joint: 5/Lead Rubber Bearing)	
Friction pendulum:	JOINT PROPERTIES NONLINEAR 37 5 (Joint: 5/Frictional Pendulum System)	
Multi-linear elastic	JOINT PROPERTIES NONLINEAR 40 5 (Joint: 5/Multi-Linear Elastic)	
Multi-linear hysteresis	JOINT PROPERTIES NONLINEAR 41 5 (Joint: 5/Multi-Linear Hysteresis)	
Multi-linear compound hysteresis	JOINT PROPERTIES NONLINEAR 42 5 (Joint: 5/Multi-Linear Compound Hysteresis)	
Axial force dependent multi-linear elastic	JOINT PROPERTIES NONLINEAR 43 5 (Joint: 5/Axial Force Dependent Multi-Linear Elastic)	
Concrete	Not applicable	
Elasto-Plastic	Not applicable	
Creep	Not applicable	
Damage	Not applicable	
Viscoelastic	Not applicable	
Shrinkage	Not applicable	
Rubber	Not applicable	
Generic Polymer	Not applicable	
Composite	Not applicable	

Loading

Prescribed Value	PDSP, TPDSP	Prescribed variable. U, V, W, θ_1 , θ_2 : at active nodes.
-------------------------	-------------	--

Concentrated Loads	CL	Concentrated loads. Px, Py, Pz, M1, M2: at active nodes.
Element Loads	Not applicable.	
Distributed Loads	Not applicable.	
Body Forces	CBF	Constant body forces for element. Xcbf, Ycbf, Zcbf, Ω_x , Ω_y , Ω_z , α_x , α_y , α_z
	BFP, BFPE	Not applicable.
Velocities	VELO	Velocities. Vx, Vy, Vz: at nodes.
Accelerations	ACCE	Accelerations. Ax, Ay, Az: at nodes.
Viscous Support Loads	VSL	Viscous support loads. VLx, VLy, VLz: at nodes.
Initial Stress/Strains	SSI, SSIE	Initial stresses/strains at nodes/for element. Fx, Fy, Fz, Mx, My, Mz: spring forces in local directions. ϵ_x , ϵ_y , ϵ_z , ψ_x , ψ_y , ψ_z : spring strains in local directions.
	SSIG	Not applicable.
Residual Stresses	Not applicable.	
Target Stress/Strains	TSSIE, TSSIA	Target stresses/strains at nodes/for element. Fx, Fy, Fz, Mx, My, Mz: spring forces in local directions. ϵ_x , ϵ_y , ϵ_z , ψ_x , ψ_y , ψ_z : spring strains in local directions.
	TSSIG	Not applicable.
Temperatures	TEMP, TMPE	Temperatures at nodes/for element. T1, T2, T3, T4, T5, T10, T20, T30, T40, T50: actual and initial spring temperatures.
Overburden	Not applicable.	
Phreatic Surface	Not applicable.	
Field Loads	Not applicable.	
Temp Dependent Loads	Not applicable.	

LUSAS Output

Solver	Force: Fx, Fy, Fz, M1, M2: spring forces in local directions. Strain: ϵ_x , ϵ_y , ϵ_z , ψ_1 , ψ_2 : spring strains in local directions.
Modeller	See Results Tables (Appendix K) .

Local Axes

- [Standard joint element](#)

Sign Convention

- [Standard joint element](#)

Formulation

Geometric Nonlinearity

Not applicable.

Integration Schemes

Stiffness	Default.	1-point.
	Fine.	As default.
Mass	Default.	1-point.
	Fine.	As default.

Mass Modelling

Lumped mass only. The position of the mass relative to the two active joint nodes is defined in the joint material data. Point mass elements should be used to model lumped masses when no stiffness modelling is required.

Options

- 55 Output strains as well as stresses.
- 119 Invokes temperature input for joints.

Notes on Use

See [Joint Element Compatibility and Notes](#).

Restrictions

Not applicable.

Recommendations on Use

- The joint elements may be used to release degrees of freedom between elements, e.g. a hinged shell, or to provide nonlinear support conditions, e.g. friction-gap condition. Also, point masses may be represented by including a joint at an element node.
- See [Joint Element Compatibility \(Appendix L\)](#)

Chapter 9 :

Thermal / Field

Elements

2D Bar Field Elements

General

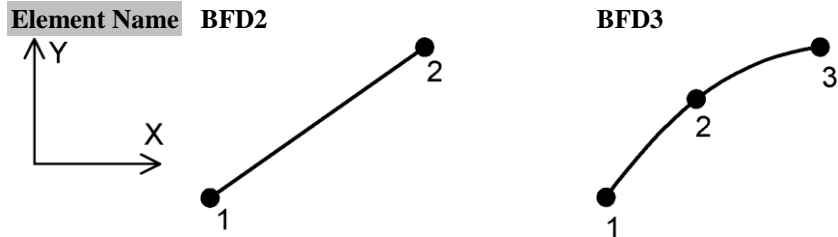

Element Name	BFD2
Element Group	Field
Element Subgroup	Thermal Bars
Element Description	Straight and curved
Number Of Nodes	2 or 3.
Freedom	φ : field value (temperature) at each node
Node Coordinates	X, Y: at each node.

Geometric Properties

$A_1 \dots A_n$ Cross-sectional area at each node.

Material Properties

Matrix	Not applicable	
Joint	Not applicable	
Composite	Not applicable	
Field	Isotropic	MATERIAL PROPERTIES FIELD ISOTROPIC (Field: Isotropic)
		MATERIAL PROPERTIES FIELD ISOTROPIC CONCRETE(Field: Isotropic)
	Orthotropic:	Not applicable
	Linear	Not applicable
	convection/radiation:	
	Arbitrary	Not applicable
	convection/radiation:	

Loading

Prescribed Value	PDSP, TPDSP	ϕ : field variable (temperature) at nodes.
Rate of Heat Inflow at a Point	RGN	Q: field loading at nodes.
Element Loads	Not applicable.	
Distributed Loads	UDL	Not applicable.
	FFL	qa: (Q/unit area) at nodes (positive defines heat input) (see FLD Face loading applied to thermal bars).
Rate of Heat Inflow/Unit Volume	RBC	qv: (Q/unit volume) for element.
	RBV, RBVE	qv: (Q/unit volume) at nodes/ for element.
Velocities	Not applicable.	
Accelerations	Not applicable.	
Viscous Support Loads	Not applicable.	
Initial Stress/Strains	Not applicable.	
Residual Stresses	Not applicable.	
Target Stress/Strains	Not applicable.	
Temperatures	TEMP, TMPE	Temperatures at nodes/for element. T, 0, 0, 0, 0, 0, 0 (See <i>Notes</i> .)
Field Loads	ENVT	Environmental boundary conditions . ϕ_e , hc, hr: external environmental temperature, convective and radiative heat transfer coefficients. (See <i>Notes</i>)
Temp Dependent Loads	TDET	Temperature dependent environmental boundary conditions . ϕ_e , hc, hr, T: external environmental temperature, convective and radiative heat transfer coefficients and temperature for element. (See <i>Notes</i>)
	RIHG	Internal heat generation rate. Q, T: coefficient/unit volume and temperature. (See <i>Notes</i>)

LUSAS Output

Solver Field variable (temperature). gx, qx: gradient and flow in local

axes.

Modeller See [Results Tables \(Appendix K\)](#).

Local Axes

- [Standard line element](#)

Sign Convention

- [Standard field element](#)

Formulation

Geometric Nonlinearity

Not applicable.

Integration Schemes

Conductivity	Default.	1-point (BFD2), 2-point (BFD3).
	Fine (see <i>Options</i>).	2-point (BFD2), 3-point (BFD3).
Specific Heat	Default.	1-point (BFD2), 2-point (BFD3).
	Fine (see <i>Options</i>).	2-point (BFD2), 3-point (BFD3).

Specific Heat Modelling

- Consistent specific heat (default).
- Lumped specific heat.

Options

- 18** Invokes fine integration rule.
- 105** Lumped specific heat.

Notes on Use

- TEMP/TMPE loading can be used to initialise the temperature field on the first step of a nonlinear field analysis. The temperature will be applied on the first pass of iteration 0 only and the load must be specified as a manual increment.
- For linear field problems only one load case is allowed if an ENVT load is to be applied.
- Load curves can be used to maintain or increment ENVT, TDET or RIHG loading as a nonlinear solution progresses.

4. Automatic load incrementation under the NONLINEAR CONTROL data chapter cannot be used with TDET or RIHG loading.
5. When using load curves with TDET loading, the environmental temperatures will be factored but the heat coefficients will remain constant. If ENVT loading is used with load curves, any component can be controlled via a load curve.
6. If radiation is to be considered the problem becomes nonlinear and NONLINEAR CONTROL must be specified.

Restrictions

- [Ensure mid-side node centrality](#)
- Avoid excessive element curvature

Recommendations on Use

These elements may be used to analyse heat conduction along bars either individually or in conjunction with continuum field elements, e.g. supporting struts.

2D Axisymmetric Membrane Field Elements

General

Element Name BFX2

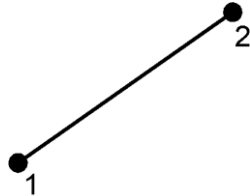
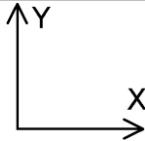

Element Name BFX3

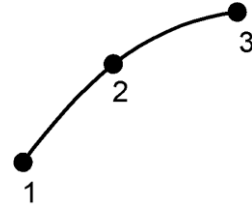

Element Group	Field
Element Subgroup	Thermal Bars
Element Description	Straight and curved isoparametric axisymmetric thermal bar elements in 2D which can accommodate varying cross sectional area.
Number Of Nodes	2 or 3.
Freedom Node	j: field variable (temperature) at each node.
Coordinates	X, Y: at each node.

Geometric Properties

$t_1... t_n$ Thickness at each node.

Material Properties

Matrix Not applicable.

Composite Not applicable.

Field Isotropic

MATERIAL PROPERTIES FIELD
ISOTROPIC (Field: Isotropic)

MATERIAL PROPERTIES FIELD
ISOTROPIC CONCRETE (Field: Isotropic)

Orthotropic:

Not applicable

Linear

Not applicable

convection/radiation:

Arbitrary

Not applicable

convection/radiation:

Not applicable

Loading

Prescribed Value	PDSP, TPDSP	φ : field variable (temperature) at nodes.
Rate of Heat Inflow at a Point	RGN	Q: field loading at nodes.
Element Loads	Not applicable.	
Distributed Loads	UDL	Not applicable.
	FFL	qa: (Q/unit area) at nodes (positive defines heat input) (see FLD Face loading applied to thermal bars).
Rate of Heat Inflow/Unit Volume	RBC	qv: (Q/unit volume) for element.
	RBV, RBVE	qv: (Q/unit volume) at nodes/ for element.
Velocities	Not applicable.	
Accelerations	Not applicable.	
Viscous	Not applicable.	
Support Loads		
Initial Stress/Strains	Not applicable.	
Residual Stresses	Not applicable.	
Target Stress/Strains	Not applicable.	
Temperatures	TEMP, TMPE	Temperatures at nodes/for element. T, 0, 0, 0, 0, 0, 0 (See <i>Notes</i> .)
Field Loads	ENVT	Environmental boundary conditions . φ_e , h_c , h_r : external environmental temperature, convective and radiative heat transfer coefficients. (See <i>Notes</i> .)
Temp Dependent Loads	TDET	Temperature dependent environmental boundary conditions . φ_e , h_c , h_r , T: external environmental temperature, convective and radiative heat transfer coefficients and temperature. (See <i>Notes</i> .)
	RIHG	Internal heat generation rate. Q, T: coefficient/unit volume and temperature for element. (See <i>Notes</i> .)

LUSAS Output

Solver Field variable (temperature). gx, qx: gradient and flow in local axes.

Modeller See [Results Tables \(Appendix K\)](#).

Local Axes

- [Standard line element](#)

Sign Convention

- [Standard field element](#)

Formulation

Geometric Nonlinearity

Not applicable.

Integration Schemes

Conductivity	Default.	1-point (BFX2), 2-point (BFX3).
	Fine (see <i>Options</i>).	2-point (BFX2), 3-point (BFX3).
Specific Heat	Default.	1-point (BFX2), 2-point (BFX3).
	Fine (see <i>Options</i>).	2-point (BFX2), 3-point(BFX3).

Specific Heat Modelling

- Consistent specific heat (default).
- Lumped specific heat.

Options

- 18** Invokes fine integration rule.
- 47** X-axis taken as axis of symmetry.
- 105** Lumped specific heat.

Notes on Use

- TEMP/TMPE loading can be used to initialise the temperature field on the first step of a nonlinear field analysis. The temperature will be applied on the first pass of iteration 0 only and the load must be specified as a manual increment.
- For linear field problems only one load case is allowed if an ENVT load is to be applied.

3. Load curves can be used to maintain or increment ENVT, TDET or RIHG loading as a nonlinear solution progresses.
4. Automatic load incrementation under the NONLINEAR CONTROL data chapter cannot be used with TDET or RIHG loading.
5. When using load curves with TDET loading, the environmental temperatures will be factored but the heat coefficients will remain constant. If ENVT loading is used with load curves, any component can be controlled via a load curve.
6. If radiation is to be considered the problem becomes nonlinear and NONLINEAR CONTROL must be specified.

Restrictions

- [Ensure mid-side node centrality](#)
- Avoid excessive element curvature

Recommendations on Use

One example of the usage of these elements is the analysis of in-plane temperature flow in a thin circular plate.

3D Bar Field Elements

General

Element Name BFS2

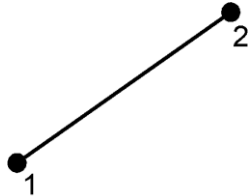
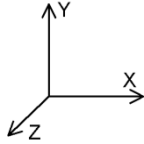

BFS3

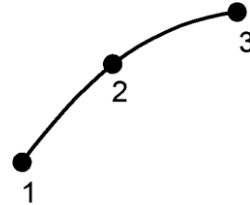

Element Group	Field
Element Subgroup	Thermal Bars
Element Description	Straight and curved
Number Of Nodes	2 or 3.
Freedom	ϕ : field value (temperature) at each node
Node Coordinates	X, Y, Z: at each node.

Geometric Properties

$A_1 \dots A_n$ Cross sectional area at each node.

Material Properties

Linear	Not applicable
Matrix	Not applicable
Joint	Not applicable
Concrete	Not applicable
Elasto-Plastic	Not applicable
Creep	Not applicable
Damage	Not applicable
Viscoelastic	Not applicable
Shrinkage	Not applicable
Rubber	Not applicable.
Generic Polymer	Not applicable
Composite	Not applicable

Field	Isotropic	MATERIAL PROPERTIES FIELD ISOTROPIC (Field: Isotropic)
		MATERIAL PROPERTIES FIELD ISOTROPIC CONCRETE (Field: Isotropic)
	Orthotropic:	Not applicable.
	Linear	Not applicable.
	convection/radiation:	
	Arbitrary	Not applicable.
	convection/radiation:	

Loading

Prescribed Value	PDSP, TPDSP	ϕ : field variable (temperature) at nodes.
Rate of Heat Inflow at a Point	RGN	Q: field loading at nodes.
Element Loads	Not applicable.	
Distributed Loads	UDL	Not applicable.
	FFL	qa: (Q/unit area) at nodes (positive defines heat input) (see FLD Face loading applied to thermal bars).
Rate of Heat Inflow/Unit Volume	RBC	qv: (Q/unit volume) for element.
	RBV, RBVE	qv: (Q/unit volume) at nodes/ for element.
Velocities	Not applicable.	
Accelerations	Not applicable.	
Viscous Support Loads	Not applicable.	
Initial Stress/Strains	Not applicable.	
Residual Stresses	Not applicable.	
Target Stress/Strains	Not applicable.	
Temperatures	TEMP, TMPE	Temperatures at nodes/for element. T, 0, 0, 0, 0, 0, 0 (See <i>Notes</i> .)
Field Loads	ENVT	Environmental boundary conditions . ϕ_e , hc, hr: external environmental temperature, convective and radiative heat transfer coefficients. (See <i>Notes</i> .)
Temp Dependent Loads	TDET	Temperature dependent environmental boundary conditions . ϕ_e , hc, hr, T: external environmental temperature,

convective and radiative heat transfer coefficients and temperature. (See *Notes*.)

RIHG Internal heat generation rate. Q, T: coefficient/unit volume, and temperature for element. (See *Notes*.)

LUSAS Output

Solver Field variable (temperature). gx, qx: gradient and flow in local axes.

Modeller See [Results Tables \(Appendix K\)](#).

Local Axes

- [Standard line element](#)

Sign Convention

- [Standard field element](#)

Formulation

Geometric Nonlinearity

Not applicable.

Integration Schemes

Conductivity	Default.	1-point (BFS2), 2-point (BFS3).
	Fine (see <i>Options</i>).	2-point (BFS2), 3-point (BFS3).
Specific Heat	Default.	1-point (BFS2), 2-point (BFS3).
	Fine (see <i>Options</i>).	2-point (BFS2), 3-point (BFS3).

Specific Heat Modelling

- Consistent specific heat (default).
- Lumped specific heat.

Options

18 Invokes fine integration rule.

105 Lumped specific heat.

Notes on Use

1. TEMP/TMPE loading can be used to initialise the temperature field on the first step of a nonlinear field analysis. The temperature will be applied on the first pass of iteration 0 only and the load must be specified as a manual increment.
2. For linear field problems only one load case is allowed if an ENVT load is to be applied.
3. Load curves can be used to maintain or increment ENVT, TDET or RIHG loading as a nonlinear solution progresses.
4. Automatic load incrementation under the NONLINEAR CONTROL data chapter cannot be used with TDET or RIHG loading.
5. When using load curves with TDET loading, the environmental temperatures will be factored but the heat coefficients will remain constant. If ENVT loading is used with load curves, any component can be controlled via a load curve.
6. If radiation is to be considered the problem becomes nonlinear and NONLINEAR CONTROL must be specified.

Restrictions

- [Ensure mid-side node centrality](#)
- Avoid excessive element curvature

2D Link Field Element

General

Element Name LFD2

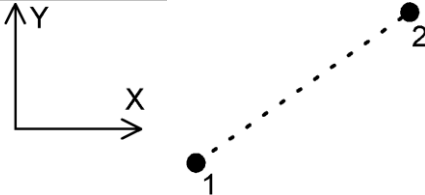

Element Group	Field
Element Subgroup	Thermal Links
Element Description	Straight conductive, convective or radiative thermal link element for 2D field analysis.
Number Of Nodes	2.
Freedom	φ : field value (temperature) at each node.
Node Coordinates	X, Y at each node.

Geometric Properties

$A_1 \dots A_n$ Cross sectional area at each node.

Material Properties

Linear	Not applicable
Matrix	Not applicable
Joint	Not applicable
Concrete	Not applicable
Elasto-Plastic	Not applicable
Creep	Not applicable
Damage	Not applicable
Viscoelastic	Not applicable
Shrinkage	Not applicable
Rubber	Not applicable
Generic Polymer	Not applicable
Composite	Not applicable
Field	Isotropic: Not applicable.

Orthotropic:	Not applicable.
Linear	MATERIAL PROPERTIES FIELD
convection/radiation:	LINK 18 (Field: Linear Link)
Arbitrary	MATERIAL PROPERTIES FIELD
convection/radiation:	LINK 19 (Field: Nonlinear Link)

Loading

Prescribed Value	PDSP, TPDSP	ϕ : field variable (temperature) at nodes.
Concentrated Loads	Not applicable.	
Element Loads	Not applicable.	
Distributed Loads	Not applicable.	
Body Forces	Not applicable.	
Velocities	Not applicable.	
Accelerations	Not applicable.	
Viscous Support Loads	Not applicable.	
Initial Stress/Strains	Not applicable.	
Residual Stresses	Not applicable.	
Target Stress/Strains	Not applicable.	
Temperatures	Not applicable.	
Field Loads	Not applicable.	
Temp Dependent Loads	Not applicable.	

LUSAS Output

Solver	Field variable (temperature). qx: flow at nodes in local directions.
Modeller	See Results Tables (Appendix K) .

Local Axes

- Standard line element

Sign Convention

- Standard field element

Formulation

Geometric Nonlinearity

Not applicable.

Integration Schemes

Conduction,	Default.	1-point (at element centroid).
Convection,		
Radiation		
	Fine.	As default.
Specific Heat	Default.	Not applicable.
	Fine.	Not applicable.

Specific Heat Modelling

Not applicable.

Options

Not applicable.

Notes on Use

No notes at present.

Restrictions

Not applicable.

Recommendations on Use

An example of the usage of these elements is the analysis of heat conduction at contacting interfaces.

3D Link Field Element

General

Element Name LFS2

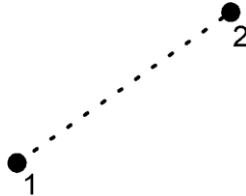
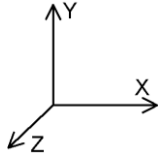

Element Group	Field
Element Subgroup	Thermal Links
Element Description	Straight conductive, convective or radiative thermal link element for 3D field analysis.
Number Of Nodes	2.
End Releases	
Freedom	ϕ : field value (temperature) at each node.
Node Coordinates	X, Y, Z at each node.

Geometric Properties

$A_1 \dots A_n$ Cross sectional area at each node.

Material Properties

Linear	Not applicable.
Matrix	Not applicable.
Joint	Not applicable.
Concrete	Not applicable.
Elasto-Plastic	Not applicable.
Rubber	Not applicable.
Generic Polymer	Not applicable.
Composite	Not applicable.
Field	Isotropic: Not applicable.
	Orthotropic: Not applicable.
	Linear: MATERIAL PROPERTIES FIELD
	convection/radiation: LINK 18 (Field: Linear Link)

	Arbitrary convection/radiation:	MATERIAL PROPERTIES FIELD LINK 19 (Field: Nonlinear Link)
Stress Potential	Not applicable.	
Creep	Not applicable.	
Damage	Not applicable.	
Viscoelastic	Not applicable.	
Shrinkage	Not applicable	

Loading

Prescribed Value	PDSP, TPDSP	φ : field variable (temperature) at nodes.
Concentrated Loads	Not applicable.	
Element Loads	Not applicable.	
Distributed Loads	Not applicable.	
Body Forces	Not applicable.	
Velocities	Not applicable.	
Accelerations	Not applicable.	
Viscous Support Loads	Not applicable.	
Initial Stress/Strains	Not applicable.	
Residual Stresses	Not applicable.	
Target Stress/Strains	Not applicable.	
Temperatures	Not applicable.	
Field Loads	Not applicable.	
Temp Dependent Loads	Not applicable.	

LUSAS Output

Solver	Field variable (temperature). qx: flow at nodes in local directions.
Modeller	See Results Tables (Appendix K) .

Local Axes

- [Standard line element](#)

Sign Convention

- [Standard field element](#)

Formulation

Geometric Nonlinearity

Not applicable.

Integration Schemes

Conduction, Convection, Radiation	Default.	1- point (at element centroid).
	Fine.	As default.
Specific Heat	Default.	Not applicable.
	Fine.	Not applicable.

Specific Heat Modelling

Not applicable.

Options

Not applicable.

Notes on Use

No notes at present.

Restrictions

Not applicable.

Recommendations on Use

An example of the usage of these elements is the analysis of heat conduction at contacting interfaces.

2D Axisymmetric Link Field Element

General

Element Name LFX2

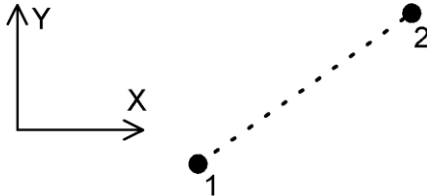

Element Group	Field
Element Subgroup	Thermal Links
Element Description	Straight conductive, convective or radiative thermal link element for 2D axisymmetric field analysis.
Number Of Nodes	2.
End Releases	
Freedom	φ : field value (temperature) at each node.
Node Coordinates	X, Y at each node.

Geometric Properties

$t_1... t_n$ Thickness at each node.

Material Properties

Linear	Not applicable.
Matrix	Not applicable.
Joint	Not applicable.
Concrete	Not applicable.
Elasto-Plastic	Not applicable.
Rubber	Not applicable.
Generic Polymer	Not applicable.
Composite	Not applicable.
Field	Isotropic: Not applicable.
	Orthotropic: Not applicable.
	Linear: MATERIAL PROPERTIES FIELD
	convection/radiation: LINK 18 (Field: Linear Link)

Arbitrary
convection/radiation:

MATERIAL PROPERTIES FIELD
LINK 19 (Field: Nonlinear Link)

Loading

Prescribed Value	PDSP, TPDSP	ϕ : field variable (temperature) at nodes.
Concentrated Loads	Not applicable.	
Element Loads	Not applicable.	
Distributed Loads	Not applicable.	
Body Forces	Not applicable.	
Velocities	Not applicable.	
Accelerations	Not applicable.	
Viscous Support Loads	Not applicable.	
Initial Stress/Strains	Not applicable.	
Residual Stresses	Not applicable.	
Target Stress/Strains	Not applicable.	
Temperatures	Not applicable.	
Field Loads	Not applicable.	
Temp Dependent Loads	Not applicable.	

LUSAS Output

Solver	Field variable (temperature). qx: flow at nodes in local directions.
Modeller	See Results Tables (Appendix K) .

Local Axes

- [Standard line element](#)

Sign Convention

- [Standard field element](#)

Formulation

Geometric Nonlinearity

Not applicable.

Integration Schemes

Conduction, Convection, Radiation	Default.	1- point (at element centroid).
	Fine.	As default.
Specific Heat	Default.	Not applicable.
	Fine.	Not applicable.

Specific Heat Modelling

Not applicable.

Options

- 47 X-axis taken as axis of symmetry.

Notes on Use

No notes at present.

Restrictions

Not applicable.

Recommendations on Use

An example of the usage of these elements is the analysis of heat conduction at contacting interfaces.

2D Axisymmetric Field Elements

General

Element Name TXF3

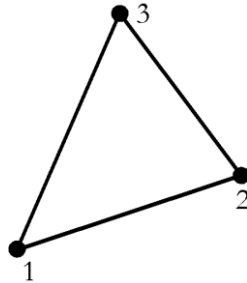
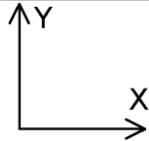

TXF6

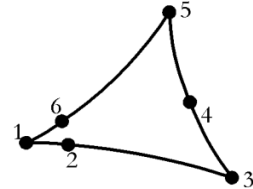

QXF4

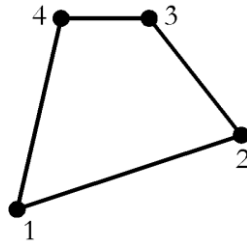

QXF8

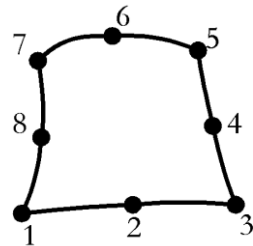

Element Group Field

Element Subgroup Plane Field

Element Description A family of axisymmetric field elements in 2D with higher order elements capable of modelling curved boundaries. The elements are applicable to both steady state and transient field problems. The formulations apply over a unit radian segment of the structure and the loading and boundary conditions are axisymmetric. The elements are numerically integrated. Axisymmetry is taken about the Y-axis by default.

Number Of Nodes 3, 4, 6, or 8 numbered anticlockwise.

Freedoms ϕ : field variable at each node.

Node Coordinates X, Y: at each node

Geometric Properties

Not applicable (a unit radian segment is assumed).

Material Properties

Linear	Not applicable.	
Matrix	Not applicable.	
Joint	Not applicable.	
Concrete	Not applicable.	
Elasto-Plastic	Not applicable.	
Rubber	Not applicable.	
Generic	Not applicable	
Polymer		
Composite	Not applicable.	
Field	Isotropic:	MATERIAL PROPERTIES FIELD ISOTROPIC (Field: Isotropic)
		MATERIAL PROPERTIES FIELD ISOTROPIC CONCRETE (Field: Isotropic)
	Orthotropic:	MATERIAL PROPERTIES FIELD ORTHOTROPIC (Field: Orthotropic)
		MATERIAL PROPERTIES FIELD ORTHOTROPIC CONCRETE (Field: Orthotropic)
	Linear	Not applicable.
	convection/radiation:	
	Arbitrary	Not applicable.
	convection/radiation:	

Loading

Prescribed Value	PDSP, TPDSP	ϕ : field variable (temperature) at nodes.
Rate of Heat Inflow at a Point	RGN	Q: field loading at nodes.
Element Loads	Not applicable.	
Distributed Loads	UDL	Not applicable.
	FFL	qa: (Q/unit area) at nodes (see FLD Face loading applied to thermal bars).
Rate of Heat Inflow/Unit Volume	RBC	qv: (Q/unit volume) for element.
	RBV, RBVE	qv: (Q/unit volume) at nodes/ for element.
Velocities	Not applicable.	
Accelerations	Not applicable.	
Viscous Support Loads	Not applicable.	

Initial Velocities	Not applicable.	
Initial Stress/Strains	Not applicable.	
Residual Stresses	Not applicable.	
Target Stress/Strains	Not applicable.	
Temperatures	Not applicable.	
Field Loads	ENV T	<u>Environmental boundary conditions.</u> ϕ_e , h_c , h_r : external environmental temperature, convective and radiative heat transfer coefficients. (See <i>Notes</i> .)
Temp Dependent Loads	TDET	<u>Temperature dependent environmental boundary conditions.</u> ϕ_e , h_c , h_r , T : external environmental temperature, convective and radiative heat transfer coefficients and temperature. (See <i>Notes</i> .)
	RIHG	Internal heat generation rate. Q , T : coefficient/unit volume and temperature for element. (See <i>Notes</i> .)

LUSAS Output

Solver	Field variable (temperature). g_x , g_y , g_z , q_x , q_y , q_z : gradients and flows in global directions.
Modeller	See Results Tables (Appendix K) .

Local Axes

Not applicable.

Sign Convention

- [Standard field element](#)

Formulation

Geometric Nonlinearity

Not applicable.

Integration Schemes

Conductivity	Default.	1-point (TXF3), 3-point (TXF6), 2x2 (QXF4, QXF8)
---------------------	----------	--

	Fine (see <i>Options</i>).	3x3 (QXF8)
Specific Heat	Default.	1-point (TXF3), 3-point (TXF6), 2x2 (QXF4, QXF8)
	Fine.	As default.

Specific Heat Modelling

- Consistent specific heat (default)
- Lumped specific heat.

Options

- 18** Invokes fine integration rule for elements.
- 47** X-axis taken as axis of symmetry.
- 105** Lumped specific heat.

Notes on Use

1. The element formulations are based on the standard [isoparametric](#) approach. The variation of field variable (temperature) within an element is linear low order (corner node only) elements and quadratic high order (mid-side node) elements.
2. All elements pass the [patch test](#) for convergence.
3. For linear field problems only one load case is allowed if an ENV T load is to be applied.
4. Load curves can be used to maintain or increment ENV T, TDET or RIHG loading as a nonlinear solution progresses.
5. Automatic load incrementation under the NONLINEAR CONTROL data chapter cannot be used with TDET or RIHG loading.
6. When using load curves with TDET loading, the environmental temperatures will be factored but the heat coefficients will remain constant. If ENV T loading is used with load curves, any component can be controlled via a load curve.
7. If radiation is to be considered the problem becomes nonlinear and NONLINEAR CONTROL must be specified.

Restrictions

- [Ensure mid-side node centrality](#)
- [Avoid excessive element curvature](#)
- Avoid excessive aspect ratio

Recommendations on Use

The axisymmetric field elements are suitable for analysing solid field problems which exhibit geometric and loading symmetry about a given axis, e.g. temperature distribution in a pipe or radial groundwater flow into a well.

2D Plane Field Elements

General

Element Name

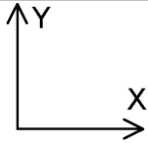

TFD3

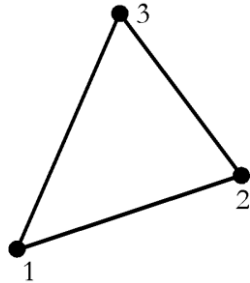

TFD6

QFD4

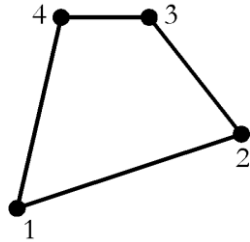

QFD8

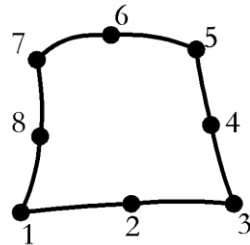

Element Group	Field
Element Subgroup	Plane Field
Element Description	A family of plane field elements in 2D with higher order elements capable of modelling curved boundaries. The elements are applicable to both steady state and transient field problems. The elements are numerically integrated.
Number Of Nodes	3, 4, 6 or 8 numbered anticlockwise.
Freedom	ϕ : field value (temperature) at each node.
Node Coordinates	X, Y: at each node.

Geometric Properties

$t_1 \dots t_n$ Thickness at each node.

Material Properties

Linear	Not applicable	
Matrix	Not applicable	
Joint	Not applicable	
Concrete	Not applicable	
Elasto-Plastic	Not applicable	
Creep	Not applicable	
Damage	Not applicable	
Viscoelastic	Not applicable	
Shrinkage	Not applicable	
Rubber	Not applicable.	
Generic Polymer	Not applicable	
Composite	Not applicable.	
Field	Isotropic:	MATERIAL PROPERTIES FIELD ISOTROPIC CONCRETE (Field: Isotropic)
	Orthotropic:	MATERIAL PROPERTIES FIELD ISOTROPIC (Field: Isotropic) MATERIAL PROPERTIES FIELD ORTHOTROPIC (Field: Orthotropic) MATERIAL PROPERTIES FIELD ORTHOTROPIC CONCRETE (Field: Orthotropic)
	Linear convection/radiation:	Not applicable.
	Arbitrary convection/radiation:	Not applicable.

Loading

Prescribed Value	PDSP, TPDSP	ϕ : field variable (temperature) at nodes.
Rate of Heat Inflow at a Point	RGN	Q: field loading at nodes.
Element Loads	Not applicable.	
Distributed Loads	UDL	Not applicable.
	FFL	qa: (Q/unit area) at nodes (see FLD Face loading applied to thermal bars).
Rate of Heat Inflow/Unit Volume	RBC	qv: (Q/unit volume) for element.
	RBV, RBVE	qv: (Q/unit volume) at nodes/ for element.
Velocities	Not applicable.	

Accelerations	Not applicable.	
Viscous Support Loads	Not applicable.	
Initial Stress/Strains	Not applicable.	
Residual Stresses	Not applicable.	
Target Stress/Strains	Not applicable.	
Temperatures	Not applicable.	
Field Loads	ENVT	Environmental boundary conditions . ϕ_e , h_c , h_r : external environmental temperature, convective and radiative heat transfer coefficients. (See <i>Notes</i> .)
Temp Dependent Loads	TDET	Temperature dependent environmental boundary conditions . ϕ_e , h_c , h_r , T : external environmental temperature, convective and radiative heat transfer coefficients and temperature. (See <i>Notes</i> .)
	RIHG	Internal heat generation rate. Q , T : coefficient/unit volume and temperature for element. (See <i>Notes</i> .)

LUSAS Output

Solver	Field variable (temperature). g_x , g_y , q_x , q_y : gradients and flows in global directions.
Modeller	See Results Tables (Appendix K) .

Local Axes

- [Standard surface element](#)

Sign Convention

- [Standard field element](#)

Formulation

Geometric Nonlinearity

Not applicable.

Integration Schemes

Conductivity	Default.	1-point (TFD3), 3-point (TFD6), 2x2 (QFD4, QFD8).
	Fine.	As default.
Specific Heat	Default.	1-point (TFD3), 3-point (TFD6), 2x2 (QFD4, QFD8).
	Fine.	Not applicable.

Specific Heat Modelling

- Consistent specific heat (default).
- Lumped specific heat.

Options

- 18** Invokes fine integration rule for elements.
- 105** Lumped specific heat.

Notes on Use

1. The element formulations are based on the standard [isoparametric](#) approach. The variation of field variable (temperature) within an element is linear for low order (corner node only) elements and quadratic for high order (mid-side node) elements.
2. All elements pass the [patch test](#) for convergence.
3. For linear field problems only one load case is allowed if an ENVT load is to be applied.
4. Load curves can be used to maintain or increment ENVT, TDET or RIHG loading as a nonlinear solution progresses.
5. Automatic load incrementation under the NONLINEAR CONTROL data chapter cannot be used with TDET or RIHG loading.
6. When using load curves with TDET loading, the environmental temperatures will be factored but the heat coefficients will remain constant. If ENVT loading is used with load curves, any component can be controlled via a load curve.
7. If radiation is to be considered the problem becomes nonlinear and NONLINEAR CONTROL must be specified.

Restrictions

- [Ensure mid-side node centrality](#)
- [Avoid excessive element curvature](#)

- Avoid excessive aspect ratio

Recommendations on Use

The plane field elements may be utilised for analysing continuum field problems whose behaviour is essentially two dimensional, e.g. thermal analysis of a long tunnel . The elements are formulated using the 2D quasi-harmonic equation. See Theory Manuals for details.

3D Solid Field Elements

General

Element Name

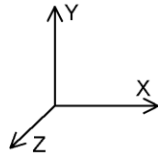

TF4

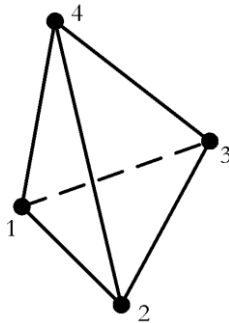

TF10

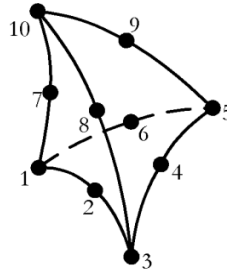

PF6

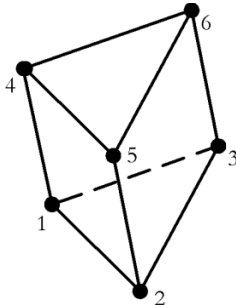

PF12

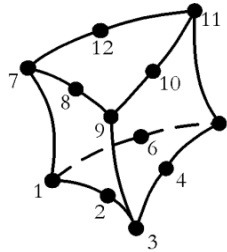

PF15

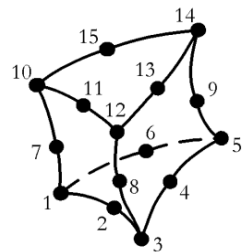

HF8

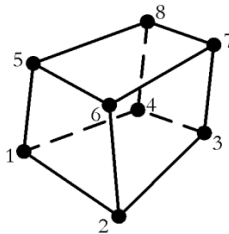

HF16

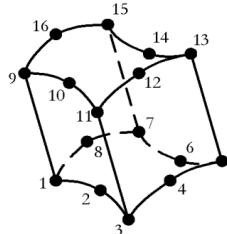

HF20

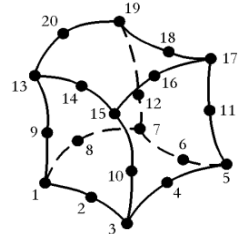

Element Group

Field

Element

Solid Field

Subgroup

Element

Description

A family of solid field elements in 3D with higher order elements capable of modelling curved boundaries. The elements are applicable to both steady state and transient field problems. The

Number Of Nodes	elements are numerically integrated. 4 and 10 (tetrahedra). 6, 12 and 15 (pentahedra). 8, 16 and 20 (hexahedra). The elements are numbered according to a right-hand screw rule in the local z-direction.
Freedoms	ϕ : field variable at each node.
Node Coordinates	X, Y, Z: at each node.

Geometric Properties

Not applicable.

Material Properties

Linear	Not applicable	
Matrix	Not applicable	
Joint	Not applicable	
Concrete	Not applicable	
Elasto-Plastic	Not applicable	
Creep	Not applicable	
Damage	Not applicable	
Viscoelastic	Not applicable	
Shrinkage	Not applicable	
Rubber	Not applicable	
Generic Polymer	Not applicable	
Composite	Not applicable	
Field	Isotropic:	MATERIAL PROPERTIES FIELD ISOTROPIC CONCRETE (Field: Isotropic)
	Orthotropic:	MATERIAL PROPERTIES FIELD ISOTROPIC (Field: Isotropic) MATERIAL PROPERTIES FIELD ORTHOTROPIC SOLID (Field: Orthotropic Solid)
	Linear	MATERIAL PROPERTIES FIELD ORTHOTROPIC SOLID CONCRETE (Field: Orthotropic Solid)
	convection/radiation:	Not applicable.
	Arbitrary	Not applicable.
	convection/radiation:	

Loading

Prescribed Value	PDSP, TPDSP	ϕ : field variable (temperature) at nodes.
Rate of Heat Inflow at a Point	RGN	Q: field loading at nodes.
Element Loads	Not applicable.	
Distributed Loads	UDL	Not applicable.
	FFL	qa: (Q/unit area) at nodes (see FLD Face loading applied to thermal bars).
Rate of Heat Inflow/Unit Volume	RBC	qv: (Q/unit volume) for element.
	RBV, RBVE	qv: (Q/unit volume) at nodes/ for element.
Velocities	Not applicable.	
Accelerations	Not applicable.	
Viscous Support Loads	Not applicable.	
Initial Stress/Strains	Not applicable.	
Residual Stresses	Not applicable.	
Target Stress/Strains	Not applicable.	
Temperatures	Not applicable.	
Field Loads	ENVT	Environmental boundary conditions . ϕ_e , hc, hr: external environmental temperature, convective and radiative heat transfer coefficients. (See <i>Notes</i> .)
Temp Dependent Loads	TDET	Temperature dependent environmental boundary conditions . ϕ_e , hc, hr, T: external environmental temperature, convective and radiative heat transfer coefficients and temperature. (See <i>Notes</i> .)
	RIHG	Internal heat generation rate. Q, T: coefficient/unit volume and temperature for element. (See <i>Notes</i> .)

LUSAS Output

Solver	Field variable (temperature). gx, gy, gz, qx, qy, qz: gradients and flows in global directions.
Modeller	See Results Tables (Appendix K) .

Local Axes

Not applicable (global axes are the reference).

Sign Convention

- Standard field element

Formulation

Geometric Nonlinearity

Not applicable.

Integration Schemes

Conductivity	Default.	1-point (TF4), 4-point (TF10), 3x2 (PF6, PF12, PF15), 2x2x2 (HF8, HF16, HF20)
	Fine (see <i>Options</i>).	5-point (TF10) 3x3x2 (HF16), 3x3x3 (HF20)
	Coarse (see <i>Options</i>).	1-point (HF20), 14-point (HF20)
Specific Heat	Default.	1-point (TF4), 4-point (TF10), 3x2 (PF6, PF12, PF15), 2x2x2 (HF8, HF16, HF20)
	Fine (see <i>Options</i>).	5-point (TF10) 3x3x2 (HF16), 3x3x3 (HF20)
	Coarse (see <i>Options</i>).	13-point (HF20), 14-point (HF20)

Specific Heat Modelling

- Consistent specific heat (default).
- Lumped specific heat.

Options

- 18** Invokes fine integration rule for elements.
- 105** Lumped specific heat.
- 155** Use 14-point integration rule for HF20.
- 156** Use 13-point integration rule for HF20.
- 398** For HF20 and HF16 with fine integration use all integration points for stress extrapolation.

Notes on Use

1. The element formulations are based on the standard isoparametric approach. The variation of potential within an element may be regarded as constant for low order (corner node only) elements and linear for high order (mid-side node) elements.
2. For linear field problems only one load case is allowed if an ENV T load is to be applied.
3. Load curves can be used to maintain or increment ENV T, TDET or RIHG loading as a nonlinear solution progresses.
4. Automatic load incrementation under the NONLINEAR CONTROL data chapter cannot be used with TDET or RIHG loading.
5. When using load curves with TDET loading, the environmental temperatures will be factored but the heat coefficients will remain constant. If ENV T loading is used with load curves, any component can be controlled via a load curve.
6. If radiation is to be considered the problem becomes nonlinear and NONLINEAR CONTROL must be specified.

Restrictions

- [Ensure mid-side node centrality](#)
- [Avoid excessive element curvature](#)
- Avoid excessive aspect ratio

Recommendations on Use

The solid field elements may be used to analyse continuum field problems where the response is fully 3D (i.e. it cannot be approximated using the plane or axisymmetric elements), e.g. temperature distribution in a pipe intersection.

3D Solid Composite Field Element (Tetrahedral)

General

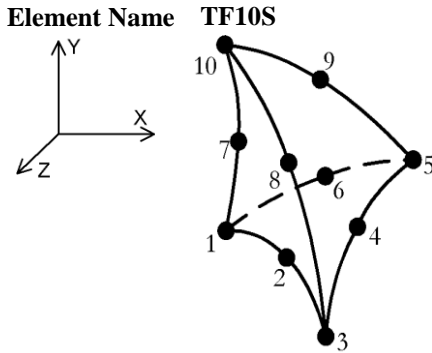

Element Group	Field
Element Subgroup	Solid Field
Element Description	3D solid field element capable of modelling curved boundaries. The element is applicable to both steady state and transient field problems. The element is numerically integrated, can be arbitrarily oriented with respect to the laminate, and allows for the fully automatic mesh generation of laminate geometric models imported from CAD packages.
Number Of Nodes	10. The element is numbered according to a right-hand screw rule in the local z-direction.
Freedom	φ : field variable at each node.
Node Coordinates	X, Y, Z: at each node.

Geometric Properties

See [Composites](#) in the *Modeller Reference Manual*

Material Properties

Linear	Not applicable
Matrix	Not applicable
Joint	Not applicable
Concrete	Not applicable
Elasto-Plastic	Not applicable
Creep	Not applicable

Damage	Not applicable	
Viscoelastic	Not applicable	
Shrinkage	Not applicable	
Rubber	Not applicable	
Generic Polymer	Not applicable	
Composite		COMPOSITE MATERIAL
Field	Isotropic:	MATERIAL PROPERTIES FIELD ISOTROPIC (Field: Isotropic) MATERIAL PROPERTIES FIELD ISOTROPIC CONCRETE (Field: Isotropic)
	Orthotropic:	MATERIAL PROPERTIES FIELD ORTHOTROPIC SOLID (Field: Orthotropic Solid) MATERIAL PROPERTIES FIELD ORTHOTROPIC SOLID CONCRETE (Field: Orthotropic Solid)
	Linear convection/radiation:	Not applicable
	Arbitrary convection/radiation:	Not applicable

Loading

Prescribed Value	PDSP, TPDSP	φ : field variable (temperature) at nodes.
Rate of Heat Inflow at a Point	RGN	Q: field loading at nodes.
Element Loads	Not applicable.	
Distributed Loads	UDL FFL	Not applicable. qa: (Q/unit area) at nodes
Rate of Heat Inflow/Unit Volume	RBC	qv: (Q/unit volume) for element.
	RBV, RBVE	qv: (Q/unit volume) at nodes/ for element.
Velocities	Not applicable.	
Accelerations	Not applicable.	
Viscous Support Loads	Not applicable.	
Initial Stress/Strains	Not applicable.	
Residual Stresses	Not applicable.	
Target Stress/Strains	Not applicable.	

Temperatures	Not applicable.	
Field Loads	ENVT	Environmental boundary conditions ϕ_e , h_c , h_r : external environmental temperature, convective and radiative heat transfer coefficients. (See <i>Notes</i> .)
Temp Dependent Loads	TDET	Temperature dependent boundary conditions . ϕ_e , h_c , h_r , T : external environmental temperature, convective and radiative heat transfer coefficients and temperature. (See <i>Notes</i> .)
	RIHG	Internal heat generation rate. Q , T : coefficient/unit volume and temperature for element. (See <i>Notes</i> .)

LUSAS Output

Solver	Field variable (temperature). g_x , g_y , g_z , q_x , q_y , q_z : gradients and flows. Gauss point values are in local directions. Nodal values are in global directions.
Modeller	See Results tables (Appendix K)

Local Axes

The local axes for each layer are defined by the LAMINAR DIRECTIONS specified for its bottom surface. The three node set in LAMINAR DIRECTIONS define the local Cartesian set origin, the x-axis and the positive quadrant of the xy-plane respectively. The local z-axis forms an orthonormal coordinate system with x and y.

Sign Convention

- [Standard field elements](#)

Formulation

Geometric Nonlinearity

Not applicable.

Integration Schemes

Conductivity	Default.	1-point for a tetrahedral subdivision (see Notes), 3-point for a pentahedral/pyramid subdivision, 2x2 for a hexahedral/wrick subdivision
	Fine (see	1-point for a tetrahedral subdivision (see Notes),

	<i>Options)</i>	3x2 for a pentahedral/pyramid subdivision, 2x2 x2 for a hexahedral/wrick subdivision
Specific Heat	Default.	5-point for the whole element or (see Options) 1-point for a tetrahedral subdivision, 3x2 for a pentahedral/pyramid subdivision, 2x2 x2 for a hexahedral/wrick subdivision
	Fine (see <i>Options)</i>	11-point or (see Options) 14 -point for the whole element

Specific Heat Modelling

- Consistent specific heat (default).
- Lumped specific heat.

Options

- 18** Invokes fine integration rule for elements.
- 91** Formulate element specific heat with fine integration
- 105** Lumped specific heat.
- 266** Layer by layer computation of specific heat matrix.
- 394** Lamina directions supported
- 395** Use 14-point fine integration rule for specific heat matrix of TH10 family (used together with 91)

Notes on Use

1. The element formulations are based on the standard isoparametric approach. The variation of field gradients within an element may be regarded as linear.
2. The LAMINAR DIRECTIONS and COMPOSITE MATERIAL data chapters must be used with this element in conjunction with the COMPOSITE ASSIGNMENTS data chapter.
3. If the whole tetrahedral element is embedded in a single lamina, a 4-point integration rule will be used for this tetrahedral subdivision; otherwise a 1-point rule will be used.
4. The specific heat matrix can be computed using a layer by layer integration (OPTION 266), however this should only be used when the thermal properties of the layers vary considerably because the computation time can be greatly increased when this OPTION is specified.
5. Numerical integration through the thickness is performed. The integration points are located in the subdivisions of each layer. Each subdivision forms the

shape of a regular 3D solid field element and the integration points are located accordingly within the subdivision as described above.

6. For linear field problems only one load case is allowed if an ENVNT load is to be applied.
7. Load curves can be used to maintain or increment ENVNT, TDET or RIHG loading as a nonlinear solution progresses.
8. Automatic load incrementation under the NONLINEAR CONTROL data chapter cannot be used with TDET or RIHG loading.
9. When using load curves with TDET loading, the environmental temperatures will be factored but the heat coefficients will remain constant. If ENVNT loading is used with load curves, any component can be controlled via a load curve.
10. If radiation is to be considered the problem becomes nonlinear and NONLINEAR CONTROL must be specified.
11. Layer 1 is always the bottom layer.

Restrictions

- [Ensure mid-side node centrality](#)
- [Avoid excessive element curvature](#)
- [Avoid excessive aspect ratio](#)

Recommendations on Use

- 3D solid composite field elements should be used for modelling thick composite structures comprising laminae of differing material properties where the computational cost of modelling each lamina with an individual solid element would be prohibitive. This field element can be used to analyse continuum field problems where the response is fully 3D.
- As these elements can be arbitrarily oriented with respect to the laminate, they are particularly aimed at the use of fully automatic mesh generation of laminate geometric models imported from CAD packages.

3D Solid Composite Field Elements (Pentahedral and Hexahedral)

General

Element Name **PF6C**

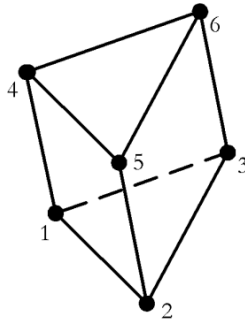
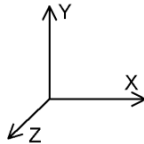

Element Name **PF12C**

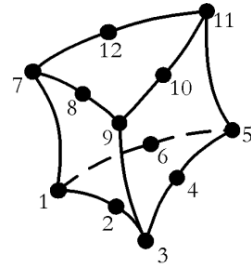

Element Name **HF8C**

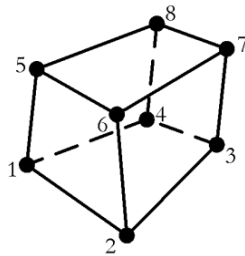

Element Name **HF16C**

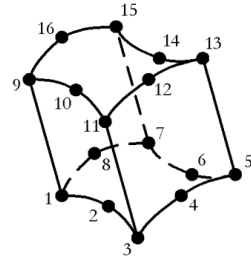

Element Group	Field
Element Subgroup	Solid Field
Element Description	3D solid field elements capable of modelling curved boundaries. The elements are applicable to both steady state and transient field problems. The elements are numerically integrated. The composite layers are parallel to the top and bottom faces and the bottom surface of the first layer coincides with the bottom surface of the element. The top and bottom faces of the element are as shown, e.g. nodes 1, 2, 3, 4 define the bottom face of HF8C
Number Of Nodes	6 or 12 (pentahedra), 8 or 16 (hexahedra). The elements are numbered according to a right-hand screw rule in the local z-direction.
Freedom Node Coordinates	ϕ : field variable at each node. X, Y, Z: at each node.

Geometric Properties

See [Composites](#) in the *Modeller Reference Manual*

Material Properties

Linear	Not applicable	
Matrix	Not applicable	
Joint	Not applicable	
Concrete	Not applicable	
Elasto-Plastic	Not applicable	
Creep	Not applicable	
Damage	Not applicable	
Viscoelastic	Not applicable	
Shrinkage	Not applicable	
Rubber	Not applicable	
Generic Polymer	Not applicable	
Composite		COMPOSITE MATERIAL
Field	Isotropic:	MATERIAL PROPERTIES FIELD ISOTROPIC (Field: Isotropic) MATERIAL PROPERTIES FIELD ISOTROPIC CONCRETE (Field: Isotropic)
	Orthotropic:	MATERIAL PROPERTIES FIELD ORTHOTROPIC SOLID (Field: Orthotropic Solid) MATERIAL PROPERTIES FIELD ORTHOTROPIC SOLID CONCRETE (Field: Orthotropic Solid)
	Linear convection/radiation:	Not applicable
	Arbitrary convection/radiation:	Not applicable

Loading

Prescribed Value	PDSP, TPDSP	φ : field variable (temperature) at nodes.
Rate of Heat Inflow at a Point	RGN	Q: field loading at nodes.
Element Loads	Not applicable.	
Distributed Loads	UDL	Not applicable.
	FFL	qa: (Q/unit area) at nodes
Rate of Heat	RBC	qv: (Q/unit volume) for element.

Inflow/Unit Volume	RBV, RBVE	qv: (Q/unit volume) at nodes/ for element.
Velocities	Not applicable.	
Accelerations	Not applicable.	
Viscous Support Loads	Not applicable.	
Initial Stress/Strains	Not applicable.	
Residual Stresses	Not applicable.	
Target Stress/Strains	Not applicable.	
Temperatures	Not applicable.	
Field Loads	ENVT	Environmental boundary conditions ϕ_e , hc, hr: external environmental temperature, convective and radiative heat transfer coefficients. (See <i>Notes.</i>)
Temp Dependent Loads	TDET	Temperature dependent boundary conditions . ϕ_e , hc, hr, T: external environmental temperature, convective and radiative heat transfer coefficients and temperature. (See <i>Notes.</i>)
	RIHG	Internal heat generation rate. Q, T: coefficient/unit volume and temperature for element. (See <i>Notes.</i>)

LUSAS Output

Solver	Field variable (temperature). gx, gy, gz, qx, qy, qz: gradients and flows. Gauss point values are in local directions. Nodal values are in global directions.
Modeller	See Results tables (Appendix K)

Local Axes

The local axes for each layer are defined using the convention for [standard area elements](#). Local axes are computed at the top and bottom quadratic surfaces (at the Gauss points) and average values are interpolated for the mid-surface. Every layer uses the same averaged values.

Sign Convention

- Standard field elements

Formulation

Geometric Nonlinearity

Not applicable.

Integration Schemes

Conductivity	Default.	1-point for each layer (PF6C), 3-point for each layer (PF12C), 2x2 for each layer (HF8C, HF16C)
	Fine (see <i>Options</i>)	3-point for each layer (PF6C), 3x3 for each layer (HF16C)
Specific Heat	Default.	3x2 for the whole element (PF6C, PF12C) or (see <i>Options</i>) 1-point for each layer (PF6C), 3-point for each layer (PF12C), 2x2x2 for the whole element or 2x2 for each layer (HF8C, HF16C)
	Fine (see <i>Options</i>)	3x2 for the whole element or 3-point for each layer (PF6C), 3x3x2 for the whole element or 3x3 for each layer (HF16C)

Specific Heat Modelling

- Consistent specific heat (default).
- Lumped specific heat.

Options

- 18** Invokes fine integration rule for elements.
- 105** Lumped specific heat.
- 266** Layer by layer computation of specific heat matrix.

Notes on Use

1. The element formulations are based on the standard isoparametric approach.
2. For linear field problems only one load case is allowed if an ENVT load is to be applied.
3. The COMPOSITE GEOMETRY and COMPOSITE MATERIAL data chapters must be used with this element in conjunction with the COMPOSITE ASSIGNMENTS data chapter.
4. Load curves can be used to maintain or increment ENVT, TDET or RIHG loading as a nonlinear solution progresses.

5. Automatic load incrementation under the NONLINEAR CONTROL data chapter cannot be used with TDET or RIHG loading.
6. When using load curves with TDET loading, the environmental temperatures will be factored but the heat coefficients will remain constant. If ENV T loading is used with load curves, any component can be controlled via a load curve.
7. If radiation is to be considered the problem becomes nonlinear and NONLINEAR CONTROL must be specified.
8. The through thickness integration is performed assuming a linear variation of the field gradient-variable matrix for each layer.
9. Layer 1 is always the bottom layer.
10. The simplifying assumptions which allow the uncoupling of in-plane and through thickness co-ordinates leads to the restriction that any individual layer should be of a constant thickness. This restriction should be considered when the finite element mesh is created and adhered to as closely as possible. In addition, out of plane lamina curvatures should also be minimised although in-plane curvature (in the x-y plane) is not restricted.

Restrictions

- [Ensure mid-side node centrality](#)
- [Avoid excessive element curvature](#)
- [Avoid excessive aspect ratio](#)
- Constant layer thickness for each individual layer

Recommendations on Use

The 3D solid composite field elements should be used for modelling thick composite structures comprising laminae of differing material properties where the computational cost of modelling each lamina with an individual solid element would be prohibitive. These field elements can be used to analyse continuum field problems where the response is fully 3D.

Chapter 10 :

Hygro-Thermal

Elements

2D Plane Hygro-Thermal Elements

General

Element Name

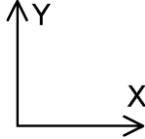

THT3

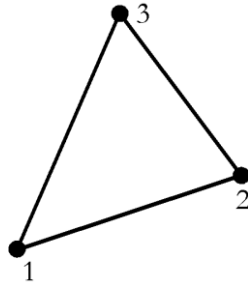

THT6

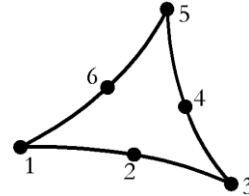

QHT4

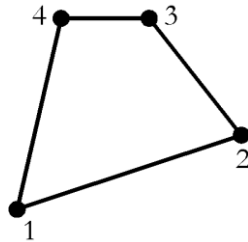

QHT8

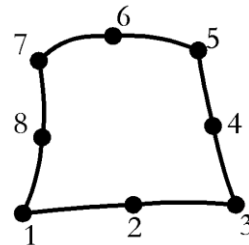

Element Group

Hygro-Thermal

Element

Plane Hygro-Thermal

Subgroup

Element
Description

A family of plane hygro-thermal elements in 2D with higher order elements capable of modelling curved boundaries. The elements can be used in hygro-thermal transient analyses, i.e. heat and moisture flow in porous media, e.g. concrete.

Number Of
Nodes

3, 4, 6 or 8 numbered anticlockwise.

Freedom
Node

T, Pc: Temperature and capillary pressure at each node.

Coordinates

X, Y: at each node.

Geometric Properties

$t_1 \dots t_n$ Thickness at each node.

Material Properties

Hygro-Thermal Linear Isotropic

MATERIAL PROPERTIES HYGRO-

Nonlinear Isotropic	THERMAL LINEAR MATERIAL PROPERTIES HYGRO- THERMAL CONCRETE
------------------------	--

Loading

Initial Conditions	TMPE	Initial temperature (T_0) and concrete relative humidity (RH) per element.
	TMP	Initial temperature (T_0) and concrete relative humidity (RH) per global nodes.
Prescribed Values	TDSP	Temperature (T) and concrete relative humidity (RH) at nodes.
	RGN	Rates of heat (QT) and/or water inflow (QW) concentrated at nodes.
	RBVE	Rates of heat and/or water inflow per unit volume, per element, can vary across the element.
	RBV	Rates of heat and/or water inflow per unit volume, per global nodes.
	RIHG	Rates of heat and/or water inflow per unit volume, per element at a specific reference nodal temperature (See Notes.)
Boundary Conditions	FFL	Rates of heat and/or water inflow per unit area (flux).
	ENVT	<u>Environmental boundary conditions</u> . Tenv, hc, hr, RH, hw: external environmental temperature, convective and radiative heat transfer coefficients, environmental relative humidity, water mass transfer coefficient. (See Notes.)
	TDET	<u>Temperature dependent environmental boundary conditions</u> . Tenv, hc, hr, RH, hw, T: external environmental temperature, convective and radiative heat transfer coefficients, environmental relative humidity, water mass transfer coefficient and reference nodal temperature. (See Notes.)

LUSAS Output

Solver	Temperature gradients	$G_T X, G_T Y$, (in global directions)
	Water saturation gradients	$G_W X, G_W Y$, (in global directions)
	Temperature fluxes	q_X, q_Y (in global directions)

Water fluxes	$J_w X, J_w Y$, (in global directions)
Vapour fluxes	$J_v X, J_v Y$, (in global directions)
Modeller	See Results Tables (Appendix K) .

Local Axes

- [Standard surface element](#)

Sign Convention

- [Standard field element](#)

Formulation

Geometric Nonlinearity

Not applicable.

Integration Schemes

1-point (THT3), 3-point (THT6), 2x2 (QHT4), 3x3 (QHT8).

Options

- 55 Output all element Gauss point derivatives and state variables

Notes on Use

1. The element formulations are based on the standard isoparametric approach. The variation of temperature and capillary pressure within an element is linear for the low order triangle and bi-linear for the low order quadrilateral; similarly it is quadratic for the higher order triangle and bi-quadratic for the higher order quadrilateral.
2. Load curves can be used to maintain or increment ENVT, TDET or RIHG loading as a nonlinear transient solution progresses.
3. Decreasing permeability and increasing water vapour convection coefficient in ENVT may result in divergence and an unstable solution. A rough estimate for the latter may be obtained by dividing the heat convection coefficient by a factor of 104 (obtained by the Chilton-Colburn analogy and scaled by an average porosity).
4. Variable thickness results in a heat and moisture transfer that is not in the plane of the element, this effect is neglected. The variable thickness influences only the amount of heat and moisture stored in the element's volume.

5. Heat of hydration loading is defined via the hygro-thermal concrete material properties.
6. Concrete relative humidity RH in TMPE, TMP and TPDSP is internally converted to capillary pressure (P_c).
7. ENVT load over the area of the element cannot be modelled.

Restrictions

- Ensure mid-side node centrality
- Avoid excessive element curvature
- Avoid excessive aspect ratio
- Certain combinations of permeability and convection boundary water vapour transfer coefficient may result in problems that do not converge.

Recommendations on Use

The plane hygro-thermal elements may be utilised for analysing continuum problems involving the heat of hydration of concrete, when behaviour is essentially two dimensional. These elements are normally used in a hygro-thermal-structural coupled analysis. They can be coupled with plane strain structural elements (since the heat/moisture exchange over the area of the element would have effect only near both ends of the 'infinite' thickness), or with thin, plane stress elements, when they are ideally isolated on both sides of their area.

2D Axisymmetric Solid Hygro-Thermal Elements

General

Element Name

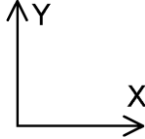

TXHT3

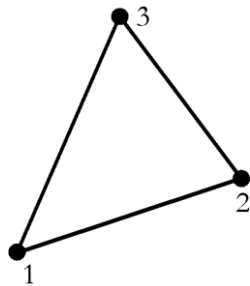

TXHT6

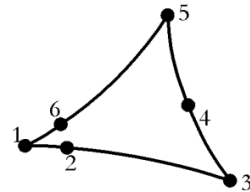

QXHT4

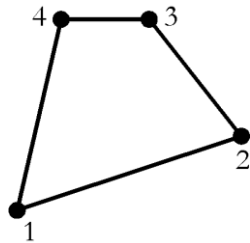

QXHT8

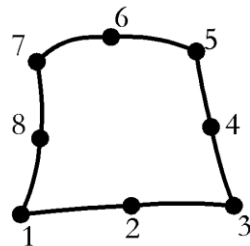

Element Group
Element Subgroup
Element Description
Number Of Nodes
Freedom
Node Coordinates

Hygro-Thermal
 Axisymmetric Solid Hygro-Thermal
 A family of axi-symmetric solid hygro-thermal elements in 2D with higher order elements capable of modelling curved boundaries. The elements can be used in hygro-thermal transient analyses, i.e. heat and moisture flow in porous media, e.g. concrete.
 3, 4, 6, or 8 numbered anticlockwise.
 T, Pc: Temperature and capillary pressure at each node.
 X, Y: at each node

Geometric Properties

Not applicable (a unit radian segment is assumed).

Material Properties

Hygro-Thermal Linear Isotropic MATERIAL PROPERTIES HYGRO-THERMAL LINEAR

Nonlinear
Isotropic

MATERIAL PROPERTIES HYGRO-
THERMAL CONCRETE

Loading

Initial Conditions	TMPE	Initial temperature (T_0) and concrete relative humidity (RH) per element.
	TMP	Initial temperature (T_0) and concrete relative humidity (RH) per global nodes.
Prescribed Values	TDSP	Temperature (T) and concrete relative humidity (RH) at nodes.
	RGN	Rates of heat (QT) and/or water inflow (QW) concentrated at nodes.
	RBVE	Rates of heat and/or water inflow per unit volume, per element, can vary across the element.
	RBV	Rates of heat and/or water inflow per unit volume, per global nodes.
	RIHG	Rates of heat and/or water inflow per unit volume, per element at a specific reference nodal temperature (See Notes.)
Boundary Conditions	FFL	Rates of heat and/or water inflow per unit area (flux).
	ENVT	<u>Environmental boundary conditions</u> . Tenv, hc, hr, RH, hw: external environmental temperature, convective and radiative heat transfer coefficients, environmental relative humidity, water mass transfer coefficient. (See Notes.)
	TDET	<u>Temperature dependent environmental boundary conditions</u> . Tenv, hc, hr, RH, hw, T: external environmental temperature, convective and radiative heat transfer coefficients, environmental relative humidity, water mass transfer coefficient and reference nodal temperature. (See Notes.)

LUSAS Output

Solver Temperature gradients $G_T X, G_T Y$, (in global directions)

Water saturation gradients $G_W X, G_W Y$, (in global directions)

Temperature fluxes	qX, qY (in global directions)
Water fluxes	J_wX, J_wY , (in global directions)
Vapour fluxes	J_vX, J_vY , (in global directions)
Modeller	See Results Tables (Appendix K) .

Local Axes

- [Standard surface element](#)

Sign Convention

- [Standard field element](#)

Formulation

Geometric Nonlinearity

Not applicable.

Integration Schemes

1-point (TXHT3), 3-point (TXHT6), 2x2 (QXHT4), 3x3 (QXHT8).

Options

- 47 Axisymmetry about the global X-axis
- 55 Output all element Gauss point derivatives and state variables

Notes on Use

- The element formulations are based on the standard isoparametric approach. The variation of temperature and capillary pressure within an element is linear for the low order triangle and bi-linear for the low order quadrilateral; similarly it is quadratic for the higher order triangle and bi-quadratic for the higher order quadrilateral.
- Load curves can be used to maintain or increment ENVT, TDET or RIHG loading as a nonlinear transient solution progresses.
- Decreasing permeability and increasing water vapour convection coefficient in ENVT may result in divergence and an unstable solution. A rough estimate for the latter may be obtained by dividing the heat convection coefficient by a factor of 104 (obtained by the Chilton-Colburn analogy and scaled by an average porosity).

4. Variable thickness results in a heat and moisture transfer that is not in the plane of the element, this effect is neglected. The variable thickness influences only the amount of heat and moisture stored in the element's volume.
5. Heat of hydration loading is defined via the hygro-thermal concrete material properties.
6. Concrete relative humidity RH in TMPE, TMP and TPDSP is internally converted to capillary pressure (P_c).

Restrictions

- Ensure mid-side node centrality
- Avoid excessive element curvature
- Avoid excessive aspect ratio
- Certain combinations of permeability and convection boundary water vapour transfer coefficient may result in problems that do not converge.

Recommendations on Use

The axi-symmetric solid hygro-thermal elements may be utilised for analysing continuum problems involving the heat of hydration of concrete, which exhibit geometric and loading symmetry about a given axis. These elements are normally used in a hygro-thermal-structural coupled analysis.

3D Solid Hygro-Thermal Elements

General

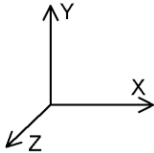
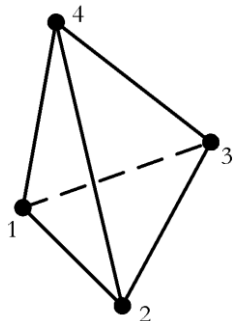
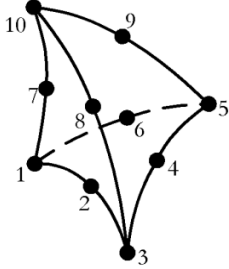
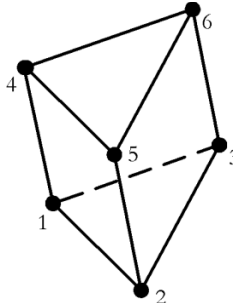
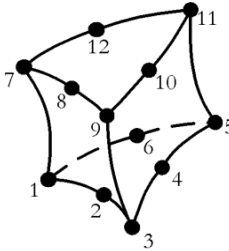
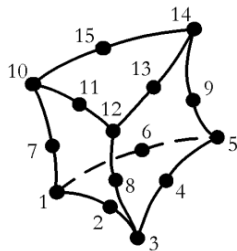
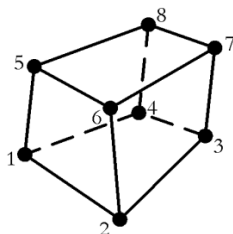
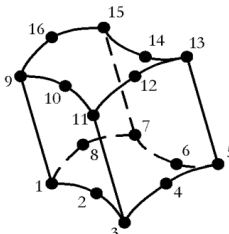
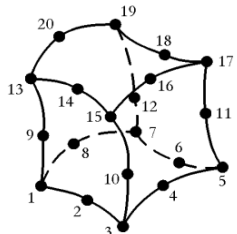
Element Name	THT4	THT10	
			
Element Group	Hygro-Thermal		
Element Subgroup	Solid Hygro-Thermal		
Element Description	A family of solid hygro-thermal elements in 3D with higher order elements capable of modelling curved boundaries. The elements can be used in hygro-thermal transient analyses, i.e. heat and moisture		
			
			

Number Of Nodes	flow in porous media, e.g. concrete 4 and 10 (tetrahedra). 6, 12 and 15 (pentahedra). 8, 16 and 20 (hexahedra). The elements are numbered according to a right-hand screw rule in the local z-direction.
Freedom Node Coordinates	T, Pc: Temperature and capillary pressure at each node. X, Y, Z: at each node.

Geometric Properties

Not applicable.

Material Properties

Hygro-Thermal	Linear Isotropic	MATERIAL PROPERTIES HYGRO-THERMAL LINEAR
	Nonlinear Isotropic	MATERIAL PROPERTIES HYGRO-THERMAL CONCRETE

Loading

Initial Conditions	TMPE	Initial temperature (T_0) and concrete relative humidity (RH) per element.
	TMP	Initial temperature (T_0) and concrete relative humidity (RH) per global nodes.
Prescribed Values	TDSP	Temperature (T) and concrete relative humidity (RH) at nodes.
	RGN	Rates of heat (QT) and/or water inflow (QW) concentrated at nodes.
	RBVE	Rates of heat and/or water inflow per unit volume, per element, can vary across the element.
	RBV	Rates of heat and/or water inflow per unit volume, per global nodes.
Boundary Conditions	RIHG	Rates of heat and/or water inflow per unit volume, per element at a specific reference nodal temperature (See Notes.)
	FFL	Rates of heat and/or water inflow per unit area (flux).
	ENVT	Environmental boundary conditions . Tenv, hc, hr, RH, hw: external environmental temperature, convective and radiative heat transfer coefficients, environmental relative humidity, water mass transfer coefficient. (See Notes.)

TDET

[Temperature dependent environmental boundary conditions](#). Tenv, hc, hr, RH, hw, T: external environmental temperature, convective and radiative heat transfer coefficients, environmental relative humidity, water mass transfer coefficient and reference nodal temperature. (See Notes.)

LUSAS Output

Solver	Temperature gradients	$G_T X, G_T Y, G_T Z$ (in global directions)
	Water saturation gradients	$G_W X, G_W Y, G_W Z$ (in global directions)
	Temperature fluxes	qX, qY, qZ (in global directions)
	Water fluxes	$J_w X, J_w Y, J_w Z$ (in global directions)
	Vapour fluxes	$J_v X, J_v Y, J_v Z$ (in global directions)
Modeller		See Results Tables (Appendix K) .

Local Axes

Not applicable (global axes are the reference).

Sign Convention

- [Standard field element](#)

Formulation

Geometric Nonlinearity

Not applicable.

Integration Schemes

1-point (THT4), 5-point (THT10), 3x2 (PHT6, PHT12, PHT15), 2x2x2 (HHT8), 3x3x2 (HHT16), 3x3x3 (HHT20)

Options

- 55 Output all element Gauss point derivatives and state variables

Notes on Use

1. The element formulations are based on the standard isoparametric approach. The distribution of temperature and capillary pressure within an element may be regarded as linear or bilinear for low order elements and quadratic or bi-quadratic for higher order elements.
2. Load curves can be used to maintain or increment ENVNT, TDET or RIHG loading as a nonlinear solution progresses.
3. Decreasing permeability and increasing water vapour convection coefficient in ENVNT may result in divergence and an unstable solution. A rough estimate for the latter may be obtained by dividing the heat convection coefficient by a factor of 104 (obtained by the Chilton-Colburn analogy and scaled by an average porosity).
4. Heat of hydration loading is defined via the hygro-thermal concrete material properties.
5. Concrete relative humidity RH in TMPE, TMP and TPDSP is internally converted to capillary pressure (P_c).

Restrictions

- Ensure mid-side node centrality
- Avoid excessive element curvature
- Avoid excessive aspect ratio
- Certain combinations of permeability and convection boundary water vapour transfer coefficient may result in problems that do not converge.

Recommendations on Use

The solid hygro-thermal elements may be used to analyse continuum problems where the response is fully 3D (i.e. it cannot be approximated using the plane or axisymmetric elements). These elements are generally used for problems involving the heat of hydration of concrete, and are normally used in a hygro-thermal-structural coupled analysis.

Chapter 11 :

Interface

Elements

2D Interface Element

General

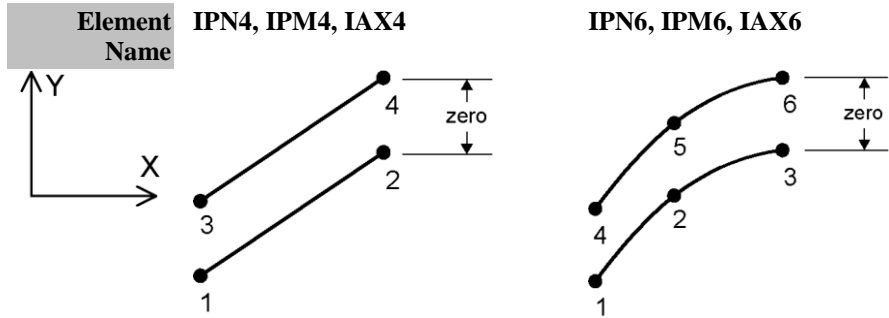

Element Group	Interface
Element Subgroup	2D Interface
Element Description	A family of 2D interface elements used for modelling standard Mohr-Coulomb friction contact as well as delamination for plane stress, plane strain and axisymmetric crack propagation. An initial gap is allowed for Mohr-Coulomb friction contact but not for delamination.
Number Of Nodes	4,6
Freedom	U, V: at each node.
Node Coordinates	X, Y: at each node.

Geometric Properties

Not applicable to plane strain and axisymmetric elements.

For plane stress t1..tn for each node

Material Properties

Linear	Not applicable
Matrix	Not applicable
Joint	Not applicable
Concrete	Not applicable
Elasto-Plastic	Not applicable
Creep	Not applicable
Damage	Not applicable
Viscoelastic	Not applicable

Shrinkage Interface	Not applicable Interface Interface	MATERIAL PROPERTIES NONLINEAR 25 MATERIAL PROPERTIES INTERFACE
Rubber Generic Polymer Composite	Not applicable Not applicable Not applicable	
Loading		
Prescribed Value Concentrated Loads	PDSP, TPDSP CL	Prescribed variable. U, V: at each node. Concentrated loads. Px, Py: at each node.
Element Loads	Not applicable.	
Distributed Loads	Not applicable.	
Body Forces	Not applicable.	
Velocities	VELO	Velocities. Vx, Vy: at nodes.
Accelerations	ACCE	Acceleration Ax, Ay: at nodes.
Viscous Support Loads	VSL	Viscous support loads. VLx, VLy: at nodes.
Initial Stress/Strains	Not applicable.	
Residual Stresses	Not applicable.	
Target Stress/Strains	Not applicable.	
Temperatures	TEMP, TMPE	Temperatures at nodes/for element. T, 0, 0, 0, To, 0, 0, 0
Overburden	Not applicable.	
Phreatic Surface	Not applicable.	
Field Loads	Not applicable.	
Temp Dependent Loads	Not applicable.	

LUSAS Output

Solver	Stress (default): shear and direct tractions. Strain: shear and direct relative displacements
Modeller	See Results Tables (Appendix K) .

Local Axes

Element Name **IPN4, IPM4, IAX4**

Evaluated at each node.

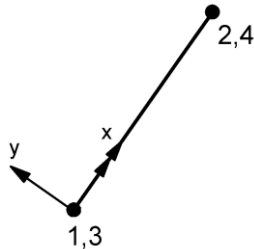

Element Name **IPN6, IPM6, IAX6**

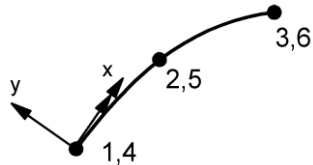

Sign Convention

A positive traction occurs if the local relative displacement (with respect to the first line of the element) is a positive value, i.e. for the quadratic elements at nodes $3 > 6$ the local relative displacement, EZ, would be positive if $(DZ_3 - DZ_6) > 0$, where DZ_i is the local displacement at node i .

Formulation

Geometric Nonlinearity

Total Lagrangian	Not applicable.
Updated Lagrangian	Not applicable.
Eulerian	Not applicable.
Co-rotational	Applicable to IPN4 and IAX4 elements.

Integration Schemes

Stiffness	Default.	2 (Newton-Cotes) (IPN4, IPM4, IAX4) 3 (Newton-Cotes) (IPN6, IPM6, IAX6)
	Fine.	As default

Mass Modelling

Not applicable.

Options

- 62** Continue solution if more than one negative pivot occurs
- 64** Non-symmetric solver
- 229** Co-rotational geometric non-linearity.

- 252 Suppress pivot warning messages.
- 261 Select the root with the lowest residual norm with arc-length.

Notes on use in delamination analyses

1. When defining the transient analysis control the arc-length procedure should be adopted with the option to select the root with the lowest residual norm [option 261].
2. It is recommended that fine integration [option 18] is selected for the parent elements.
3. The nonlinear convergence criteria should be selected to converge on the residual norm.
4. Option 62, Continue solution if more than one negative pivot occurs, should be selected to continue if more than one negative pivot is encountered and option 252 should be used to suppress pivot warning messages from the solution process.
5. The non-symmetric solver is selected automatically when mixed mode delamination is specified.
6. Although the solution is largely independent of the mesh discretisation, to avoid convergence difficulties it is recommended that at least 2 elements are placed in the process zone.

Restrictions

None.

Recommendations on Use

These elements may be used to model contact between two bodies. For delamination problems they should be placed at sites of potential delamination between 2D plane and axisymmetric continuum elements. The non-symmetric solver should be used.

2D Two Phase Interface Element

General

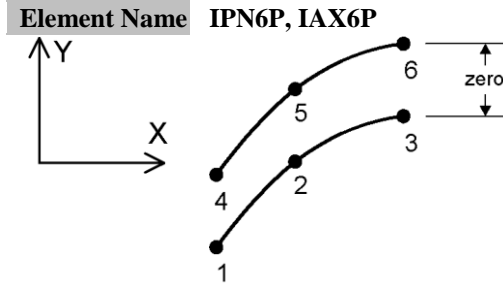

Element Group	Interface
Element Subgroup	2D Two-phase Interface
Element Description	A family of 2D interface elements used for modelling standard Mohr-Coulomb friction contact in soil/structure interactions.
Number Of Nodes	6
Freedom Node	U, V, P: at end nodes, U,V at middle nodes.
Coordinates	X, Y: at each node.

Geometric Properties

Not applicable to plane strain and axisymmetric elements.
 For plane stress t1..tn for each node

Material Properties

Linear	Not applicable
Matrix	Not applicable
Joint	Not applicable
Concrete	Not applicable
Elasto-Plastic	Not applicable
Creep	Not applicable
Damage	Not applicable
Viscoelastic	Not applicable
Shrinkage	Not applicable
Interface	Interface

MATERIAL PROPERTIES
NONLINEAR 25

	Interface	MATERIAL PROPERTIES INTERFACE
Rubber	Not applicable	
Generic Polymer	Not applicable	
Composite	Not applicable	
Two-Phase	Interface	TWO PHASE MATERIAL INTERFACE

Loading

Prescribed Value	PDSP, TPDSP	Prescribed variable. U, V, P: at end nodes, U,V at middle nodes.
Concentrated Loads	CL	Concentrated loads. Px, Py, Q: at end nodes, Px, Py at middle nodes.
Element Loads	Not applicable.	
Distributed Loads	Not applicable.	
Body Forces	Not applicable.	
Velocities	VELO	Velocities. Vx, Vy: at nodes.
Accelerations	ACCE	Acceleration Ax, Ay: at nodes.
Viscous Support Loads	VSL	Viscous support loads. VLx, VLy: at nodes.
Initial Stress/Strains	Not applicable.	
Residual Stresses	Not applicable.	
Target Stress/Strains	Not applicable.	
Temperatures	TEMP, TMPE	Temperatures at nodes/for element. T, 0, 0, 0, To, 0, 0, 0
Overburden	Not applicable.	
Phreatic Surface	Not applicable.	
Field Loads	Not applicable.	
Temp Dependent Loads	Not applicable.	

LUSAS Output

Solver	Stress (default): shear and direct tractions. Strain: shear and direct relative displacements
Modeller	See Results Tables (Appendix K) .

Local Axes

Element Name **IPN6P, IAX6P**

Evaluated at
each node.

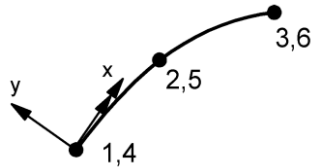

Sign Convention

A positive traction occurs if the local relative displacement (with respect to the first line of the element) is a positive value, i.e. for the quadratic elements at nodes $3 > 6$ the local relative displacement, EZ , would be positive if $(DZ3 - DZ6) > 0$, where DZ_i is the local displacement at node i .

Formulation

Geometric Nonlinearity

Total Lagrangian	Not applicable.
Updated Lagrangian	Not applicable.
Eulerian	Not applicable.
Co-rotational	Not applicable.

Integration Schemes

Stiffness	Default.	3 (Newton-Cotes)
	Fine.	As default

Mass Modelling

Not applicable.

Options

64	Non-symmetric solver
-----------	----------------------

Restrictions

None.

Recommendations on Use

These elements should be used to model soil/structure and soil/soil interactions. The nonsymmetric solver should be used.

3D Interface Element

General

Element Name

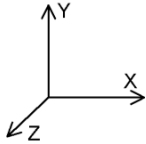

IS6

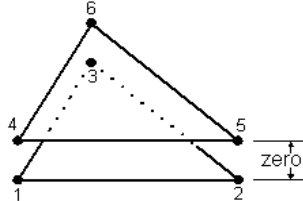

IS8

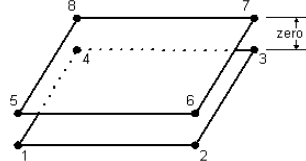

IS12

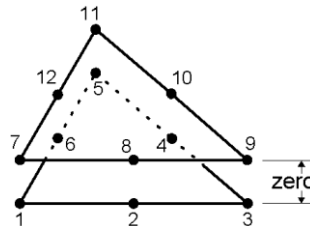

IS16

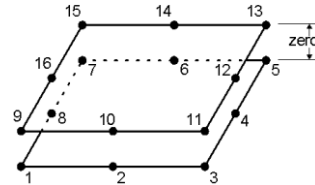

Element Group

Interface

Element

3D Interface

Subgroup

Element

A family of 3D interface elements used for modelling delamination and crack propagation.

Description

Number Of

6,8,12,16

Nodes

Freedom

U, V, W: at each node.

Node

X, Y, Z: at each node.

Coordinates

Geometric Properties

Not applicable (a zero thickness is assumed).

Material Properties

Linear	Not applicable
Matrix	Not applicable
Joint	Not applicable
Concrete	Not applicable

Elasto-Plastic	Not applicable	
Creep	Not applicable	
Damage	Not applicable	
Viscoelastic	Not applicable	
Shrinkage	Not applicable	
Interface	Interface	MATERIAL PROPERTIES NONLINEAR 25
	Interface	MATERIAL PROPERTIES INTERFACE
Rubber	Not applicable	
Generic Polymer	Not applicable	
Composite	Not applicable	
Loading		
Prescribed Value	PDSP, TPDSP	Prescribed variable. U, V, W: at each node.
Concentrated Loads	CL	Concentrated loads. Px, Py, Pz: at each node.
Element Loads	Not applicable.	
Distributed Loads	Not applicable.	
Body Forces	Not applicable.	
Velocities	VELO	Velocities. Vx, Vy, Vz: at nodes.
Accelerations	ACCE	Acceleration Ax, Ay, Az: at nodes.
Viscous Support Loads	VSL	Viscous support loads. VLx, VLy, VLz: at nodes.
Initial Stress/Strains	Not applicable.	
Residual Stresses	Not applicable.	
Target Stress/Strains	Not applicable.	
Temperatures	TEMP, TMPE	Temperatures at nodes/for element. T, 0, 0, 0, To, 0, 0, 0
Overburden	Not applicable.	
Phreatic Surface	Not applicable.	
Field Loads	Not applicable.	

Temp Dependent Not
Loads applicable.

LUSAS Output

Solver Stress (default): shear tractions in X and Y, and direct tractions.
 Strain: relative displacements in X, Y and Z directions.
Modeller See Results Tables (Appendix K).

Local Axes

Element Name IS6

Evaluated at
 each node.

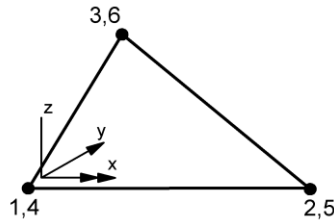

IS12

Evaluated at
 each node.

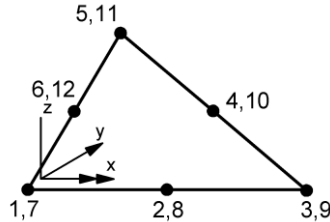

IS8

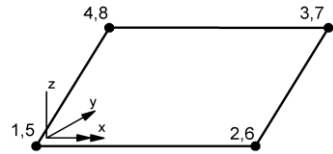

IS16

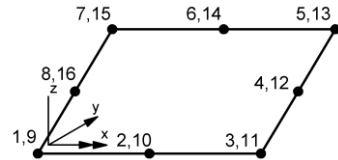

Sign Convention

A positive traction occurs if the local relative displacement (with respect to the first surface of the element) is a positive value, i.e. for the IS16 element at nodes 3 > 11 the local relative displacement, EZ, would be positive if $(DZ_{11} - DZ_3) > 0$, where Dz_i is the local displacement at node i .

Formulation

Geometric Nonlinearity

Total Lagrangian Not applicable.
Updated Lagrangian Not applicable.
Eulerian Not applicable.

Co-rotational Applicable to IS6 and IS8 elements.

Integration Schemes

Stiffness Default. 3x3 ([Newton-Cotes](#)) (IS16), 2x2 (Newton Cotes) (IS8), 7-point cubic (IS12), 3-point (IS6)
 Fine. As default

Mass Modelling

Not applicable.

Options

- 62** Continue solution if more than one negative pivot occurs.
- 64** Non-symmetric solver.
- 229** Co-rotational geometric non-linearity.
- 252** Suppress pivot warning messages
- 261** Select the root with the lowest residual norm with arc-length.

Notes on Use

1. When defining the transient analysis control the arc-length procedure should be adopted with the option to select the root with the lowest residual norm [option 261].
2. It is recommended that fine integration [option 18] is selected for the parent elements.
3. The nonlinear convergence criteria should be selected to converge on the residual norm.
4. Option 62, Continue solution if more than one negative pivot occurs, should be selected to continue if more than one negative pivot is encountered and option 252 should be used to suppress pivot warning messages from the solution process.
5. The non-symmetric solver is selected automatically when mixed mode delamination is specified.
6. Although the solution is largely independent of the mesh discretisation, to avoid convergence difficulties it is recommended that at least 2 elements are placed in the process zone.

Restrictions

None.

Recommendations on Use

These elements should be used at places of potential delamination between 3D continuum elements. The non-symmetric solver should be used.

3D Two Phase Interface Element

General

Element Name

IS12P

IS16P

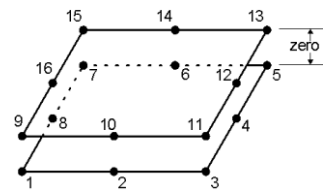
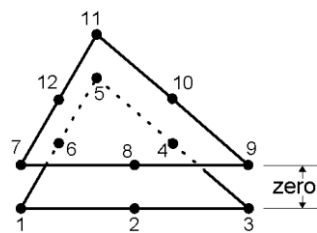
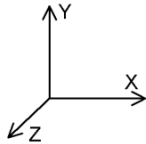

Element Group
Element Subgroup
Element Description
Number Of Nodes
Freedom Node Coordinates

Interface
 3D Two Phase Interface
 A family of 3D interface elements used for modelling soil/structure interactions
 12,16
 U, V, W, P: at corner nodes, U, V, W at midside nodes
 X, Y, Z: at each node.

Geometric Properties

Not applicable (a zero thickness is assumed).

Material Properties

Linear Not applicable
Matrix Not applicable
Joint Not applicable
Concrete Not applicable
Elasto-Plastic Not applicable
Creep Not applicable
Damage Not applicable
Viscoelastic Not applicable
Shrinkage Not applicable
Interface Interface

MATERIAL PROPERTIES
 NONLINEAR 25
 MATERIAL PROPERTIES
 INTERFACE

Two-phase Rubber	Interface	TWO PHASE MATERIAL INTERFACE
Generic Polymer	Not applicable	
Composite	Not applicable	

Loading

Prescribed Value	PDSP, TPDSP	Prescribed variable. U, V, W, Q: at corner nodes U,V,W at midside nodes.
Concentrated Loads	CL	Concentrated loads. Px, Py, Pz, Q: at corner nodes, Px, Py, Pz at midside nodes.
Element Loads	Not applicable.	
Distributed Loads	Not applicable.	
Body Forces	Not applicable.	
Velocities	VELO	Velocities. Vx, Vy, Vz: at nodes.
Accelerations	ACCE	Acceleration Ax, Ay, Az: at nodes.
Viscous Support Loads	VSL	Viscous support loads. VLx, VLy, VLz: at nodes.
Initial Stress/Strains	Not applicable.	
Residual Stresses	Not applicable.	
Target Stress/Strains	Not applicable.	
Temperatures	TEMP, TMPE	Temperatures at nodes/for element. T, 0, 0, 0, To, 0, 0, 0
Overburden	Not applicable.	
Phreatic Surface	Not applicable.	
Field Loads	Not applicable.	
Temp Dependent Loads	Not applicable.	

LUSAS Output

Solver	Stress (default): shear tractions in X and Y, and direct tractions. Strain: relative displacements in X, Y and Z directions.
---------------	---

Modeller See [Results Tables \(Appendix K\)](#).

Local Axes

Element Name IS6

Evaluated at each node.

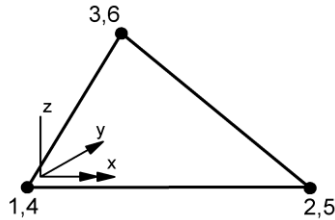

IS8

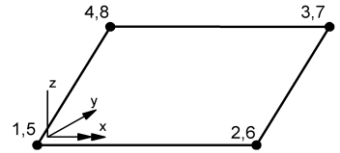

IS12

Evaluated at each node.

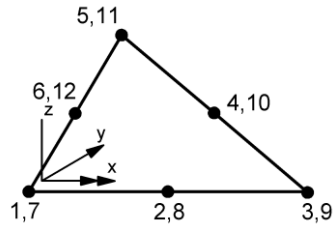

IS16

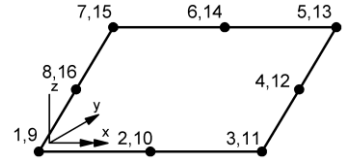

Sign Convention

A positive traction occurs if the local relative displacement (with respect to the first surface of the element) is a positive value, i.e. for the IS16 element at nodes $3 > 11$ the local relative displacement, EZ , would be positive if $(Dz_{11} - Dz_3) > 0$, where Dz_i is the local displacement at node i .

Formulation

Geometric Nonlinearity

Total Lagrangian	Not applicable.
Updated Lagrangian	Not applicable.
Eulerian	Not applicable.
Co-rotational	Applicable to IS6 and IS8 elements.

Integration Schemes

Stiffness	Default.	3x3 (Newton-Cotes) (IS16), 2x2 (Newton Cotes) (IS8), 7-point cubic (IS12), 3-point (IS6)
	Fine.	As default

Mass Modelling

Not applicable.

Options

64 Non-symmetric solver.

Restrictions

None.

Recommendations on Use

These elements should be used to model soil/structure and soil/soil interactions. The non-symmetric solver should be used.

Chapter 12 : Non-Structural Elements

2D Point Mass Element

General

Element Name PM2

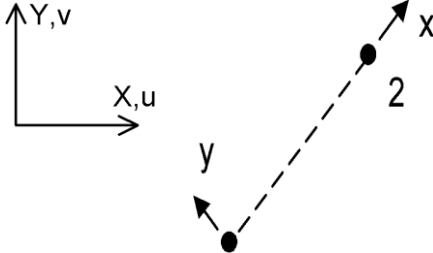

Element Group	Non-Structural Mass
Element Subgroup	2D Point
Element Description	A 2D point mass element to model mass at a point.
Number Of Nodes	2. The 2 nd node is used to define the local x-axis.
Freedoms Node	U, V: at each node.
Coordinates	X, Y: at each node.

Geometric Properties

Not applicable.

Material Properties

Linear	Not applicable	
Matrix	Not applicable	
Joint	Not applicable	
Mass	2D	MATERIAL PROPERTIES MASS 2 1
Concrete	Not applicable	
Elasto-Plastic	Not applicable	
Creep	Not applicable	
Damage	Not applicable	
Viscoelastic	Not applicable	
Shrinkage	Not applicable	
Rubber	Not applicable	
Generic Polymer	Not applicable	

Composite	Not applicable
Field	Not applicable

Loading

Prescribed Value	CBF	Constant body forces for element. Xcbf, Ycbf, Zcbf (applied as accelerations)
-------------------------	-----	---

LUSAS Output

None

Local Axes

The 2nd node is used to define the local x-axis.

Sign Convention

- Not applicable.

Formulation

Geometric Nonlinearity

Not applicable.

Integration Schemes

Not applicable.

Mass Modelling

- Consistent mass (default).
- Lumped mass.

Options

105 Lumped mass matrix.

Notes on Use

1. Use to model point mass in a structure.

Restrictions

None.

Recommendations on Use

The 2D point mass element can be used to model point masses occur in a 2D structure.

3D Point Mass Element

General

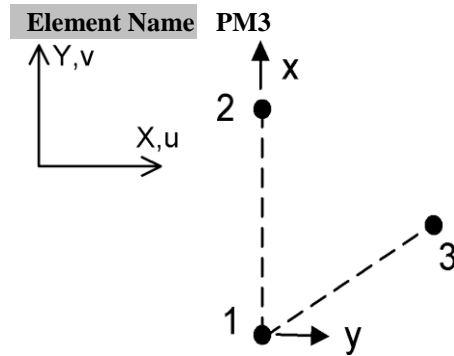

Element Group	Non-Structural Mass
Element Subgroup	3D Point
Element Description	A 3D point mass element to model mass at a point.
Number Of Nodes	3. The 2nd node is used to define the local x-axis. The 2nd and 3rd node define the local x-y plane.
Freedom Node	U, V, W: at each node.
Coordinates	X, Y, Z: at each node.

Geometric Properties

Not applicable.

Material Properties

Linear	Not applicable
Matrix	Not applicable
Joint	Not applicable
Mass	3D.
Concrete	Not applicable
Elasto-Plastic	Not applicable
Creep	Not applicable
Damage	Not applicable
Viscoelastic	Not applicable
Shrinkage	Not applicable

MATERIAL PROPERTIES MASS 3 1

Rubber	Not applicable
Generic Polymer	Not applicable
Composite	Not applicable

Loading

Prescribed Value	CBF	Constant body forces for element. Xcbf, Ycbf, Zcbf (applied as accelerations)
-------------------------	-----	---

Output

None

Local Axes

The 2nd node is used to define the local x-axis. The 2nd and 3rd node define the local x-y plane.

Sign Convention

- Not applicable.

Formulation

Geometric Nonlinearity

Not applicable.

Integration Schemes

Not applicable.

Mass Modelling

- Consistent mass (default).
- Lumped mass.

Options

105 Lumped mass matrix.

Notes on Use

1. Use to model point mass in a structure.

Restrictions

None.

Recommendations on Use

The 3D point mass element can be used to model point masses occur in a 3D structure.

3D Line Mass Elements

General

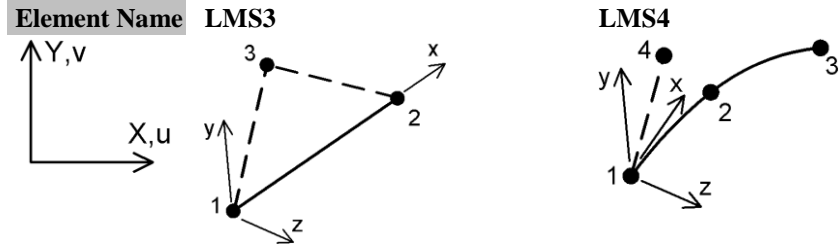

Element Name	LMS3
Element Group	Non-Structural Mass
Element Subgroup	3D Line
Element Description	3D straight (LMS3) and curved (LMS4) line mass elements to model mass along an edge. The elements can accommodate varying mass along the length.
Number Of Nodes	3 (LMS3). The 3 rd node is used to define the local x-y plane. 4 (LMS4). The 4 th node is used to define the local x-y plane.
End Releases	
Freedom	U, V, W, θ_x , θ_y , θ_z : at each active node (see Notes).
Node Coordinates	X, Y, Z : at each node.

Geometric Properties

Not applicable.

Material Properties

Linear	Not applicable
Matrix	Not applicable
Joint	Not applicable.
Mass	3D. MATERIAL PROPERTIES MASS 3 2 (or 3)
Concrete	Not applicable
Elasto-Plastic	Not applicable
Creep	Not applicable
Damage	Not applicable
Viscoelastic	Not applicable
Shrinkage	Not applicable

Rubber	Not applicable
Generic Polymer	Not applicable
Composite	Not applicable

Loading

Prescribed Value	CBF	Constant body forces for element. Xcbf, Ycbf, Zcbf (applied as accelerations)
-------------------------	-----	---

Output

None

Local Axes

- [Standard Line Element](#)

Sign Convention

- Not applicable.

Formulation

Geometric Nonlinearity

Not applicable.

Integration Schemes

Mass	Default.	2-point
	Fine	2-point (LMS2), 3-point (LMS3)

Mass Modelling

- Consistent mass (default).
- Lumped mass.

Options

18	Invokes fine integration rule.
105	Lumped mass matrix.

Notes on Use

1. Use to model mass on an edge in a structure.
2. There is no mass associated with the rotational degrees of freedom θ_x , θ_y , θ_z ; these freedoms are used purely to orientate the directions of the local element

axes. If the LMS3/LMS4 elements are connected to an element that does not possess the same rotational degrees of freedom (e.g. the edge of a continuum element), then the rotational degrees of freedom will automatically be restrained.

Restrictions

- [Ensure mid-side node centrality](#)
- Avoid excessive element curvature

Recommendations on Use

3D line mass elements can be used to model masses along an edge in a 3D structure.

2D Line Mass Elements

General

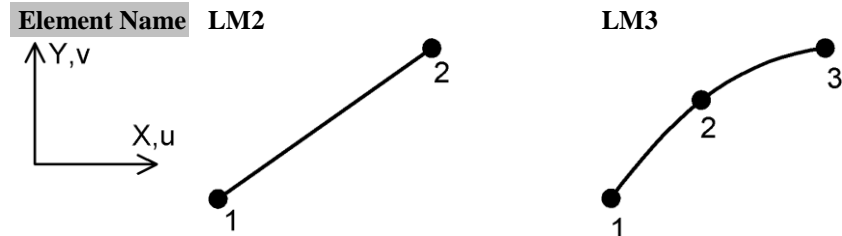

Element Group	Non-Structural Mass
Element Subgroup	2D Line
Element Description	2D straight (LM2) and curved (LM3) line mass elements to model mass along an edge. The elements can accommodate varying mass along the length.
Number Of Nodes	2 (LM2). 3 (LM3).
End Releases	
Freedom Node	U, V: at each node. X, Y: at each node.
Coordinates	

Geometric Properties

Not applicable.

Material Properties

Linear	Not applicable	
Matrix	Not applicable	
Joint	Not applicable	
Mass	2D.	MATERIAL PROPERTIES MASS 2 2 (or 3)
Concrete	Not applicable	
Elasto-Plastic	Not applicable	
Creep	Not applicable	
Damage	Not applicable	
Viscoelastic	Not applicable	
Shrinkage	Not applicable	
Rubber	Not applicable	

Generic Polymer Not applicable
Composite Not applicable

Loading

Prescribed Value CBF Constant body forces for element. Xcbf, Ycbf, Zcbf (applied as accelerations)

Output

None

Local Axes

- [Standard Line Element](#)

Sign Convention

- Not applicable.

Formulation

Geometric Nonlinearity

Not applicable.

Integration Schemes

Mass	Default.	2-point
	Fine	2-point (LM2), 3-point (LM3)

Mass Modelling

- Consistent mass (default).
- Lumped mass.

Options

18	Invokes fine integration rule.
105	Lumped mass matrix.

Notes on Use

1. Use to model mass on an edge in a structure.

Restrictions

- [Ensure mid-side node centrality](#)

- ❑ Avoid excessive element curvature

Recommendations on Use

2D line mass elements can be used to model masses along an edge in a 2D structure.

Surface Mass Elements

General

Element Name TM3

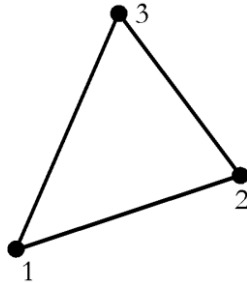
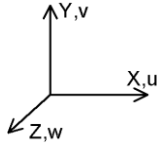

TM6

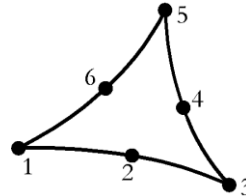

QM4

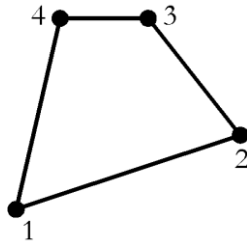

QM8

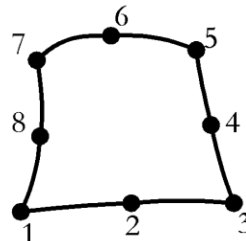

Element Group	Non-Structural Mass
Element Subgroup	3D Surface
Element Description	3D surface mass elements to model mass on a surface.
Number Of Nodes	3,4,6 or 8.
End Releases	
Freedom Node	U, V, W: at each node. X, Y, Z: at each node.
Coordinates	

Geometric Properties

Not applicable.

Material Properties

Linear Not applicable
Matrix Not applicable

Joint	Not applicable	
Mass	3D	MATERIAL PROPERTIES MASS 3 (3,4,6 or 8)
Concrete	Not applicable.	
Elasto-Plastic	Not applicable.	
Creep	Not applicable	
Damage	Not applicable	
Viscoelastic	Not applicable	
Shrinkage	Not applicable	
Rubber	Not applicable	
Generic Polymer	Not applicable	
Composite	Not applicable.	

Loading

Prescribed Value	CBF	Constant body forces for element. Xcbf, Ycbf, Zcbf (applied as accelerations)
-------------------------	-----	---

Output

None

Local Axes

- [Standard Surface Element](#)

Sign Convention

Not applicable.

Formulation

Geometric Nonlinearity

Not applicable.

Integration Schemes

Mass	Default.	1-point (TM3), 3-point (TM6), 4-point (QM4,QM8)
	Fine	3-point (TM3, TM6), 4-point (QM4), 9-point (QM8)

Mass Modelling

- Consistent mass (default).
- Lumped mass.

Options

- | | |
|-----|--------------------------------|
| 18 | Invokes fine integration rule. |
| 105 | Lumped mass matrix. |

Notes on Use

1. Use to model mass on a surface in a structure.

Restrictions

- [Ensure mid-side node centrality](#)
- [Avoid excessive element curvature](#)
- Avoid excessive aspect ratio

Recommendations on Use

The surface mass elements can be used to model masses on a surface 3D structures.

Chapter 13 : Rigid Slideline Elements

Rigid Slideline Surface 2D Elements

General

Element Name R2D2

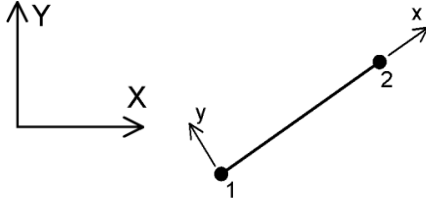

Element Group	Rigid
Element Subgroup	2D Rigid Slideline Surface
Element Description	2D Rigid Slideline Surface elements capable of modelling non-deformable surfaces in a contact analysis.
Number Of Nodes	2
Freedom Node	U, V at each node
Coordinates	X, Y at each node.

Geometric Properties

Not applicable.

Material Properties

Linear Isotropic:

MATERIAL PROPERTIES (Elastic:
Isotropic)

Loading

Prescribed Value Concentrated Loads	PDSP, TPDSP Not applicable.	Prescribed variable. U, V at each node.
Element Loads	Not applicable.	
Distributed Loads	Not applicable.	
Body Forces	Not applicable.	
Velocities	VELO	Velocities. Vx, Vy at nodes.
Accelerations	ACCE	Acceleration Ax, Ay at nodes.
Viscous Support Loads	Not applicable.	

Initial Stress/Strains	Not applicable.
Residual Stresses	Not applicable.
Temperatures	Not applicable.
Field Loads	Not applicable.
Temp Dependent Loads	Not applicable.

LUSAS Output

Solver	Displacements & Reactions only.
Modeller	Displacements & Reactions only.

Formulation

Geometric Nonlinearity

Total Lagrangian	Depends on the other surface (deformable surface) which is in contact with the rigid surface. See the related section for the deformable surface elements.
Updated Lagrangian	As above.
Eulerian	As above.
Co-rotational	As above.

Integration Schemes

Not applicable.

Mass Modelling

Not applicable.

Restrictions

- A rigid slideline surface cannot contact another rigid slideline surface.
- Rigid slideline surface elements do not accept external applied forces.

Notes on use

1. All the rigid slideline surface element nodes must be fully restrained.

2. There is no stress and strain calculation for these elements.
3. If rigid slideline surfaces are defined there is no need to assign geometric and material properties to these elements. However, when using automatic contact surfaces, linear elastic isotropic material properties need to be assigned.
4. For saving analysis time a one pass contact algorithm can be used. In this case only the penetration of the deformable surface into the rigid slideline surface is checked. To avoid the penetration of the rigid surface into the deformable surface use either the default two pass algorithm or a finer mesh on the deformable surface.

Recommendations on Use

These elements should be used when one of the surfaces which come into contact is non-deformable. Using these elements will make the analysis faster.

Rigid Slideline Surface 3D Elements

General

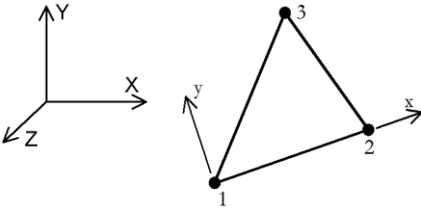
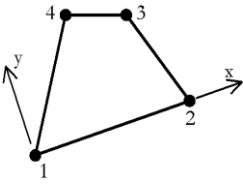
Element Name	R3D3		
Element Group	Rigid		
Element Subgroup	3D Rigid Slideline Surface		
Element Description	3D Rigid Slideline Surface elements capable of modelling non-deformable surfaces in a contact analysis.		
Number Of Nodes	3/4		
Freedom Node Coordinates	U, V, W at each node. X, Y, Z at each node.		

Geometric Properties

Not applicable.

Material Properties

Linear Isotropic:

MATERIAL PROPERTIES (Elastic: Isotropic)

Loading

Prescribed Value	PDSP, TPDSP	Prescribed variable. U, V, W at each node.
Concentrated Loads	Not applicable.	
Element Loads	Not applicable.	
Distributed Loads	Not applicable.	
Body Forces	Not applicable.	
Velocities	VELO	Velocities. V_x , V_y , V_z at nodes.
Accelerations	ACCE	Acceleration A_x , A_y , A_z at nodes.

Viscous Support Loads	Not applicable.
Initial Stress/Strains	Not applicable.
Residual Stresses	Not applicable.
Temperatures	Not applicable.
Field Loads	Not applicable.
Temp Dependent Loads	Not applicable.

LUSAS Output

Solver	Displacements & Reactions only.
Modeller	Displacements & Reactions only.

Formulation

Geometric Nonlinearity

Total Lagrangian	Depends on the other surface (deformable surface) which is in contact with the rigid surface. See the related section for the deformable surface elements.
Updated Lagrangian	As above.
Eulerian	As above.
Co-rotational	As above.

Integration Schemes

Not applicable.

Mass Modelling

Not applicable.

Restrictions

- A rigid slideline surface cannot contact another rigid surface.
- Rigid slideline surface elements do not accept external applied forces.

Notes on use

1. All the rigid slideline surface element nodes must be fully restrained.
2. There is no stress and strain calculation for these elements.
3. If rigid slideline surfaces are defined there is no need to assign geometric and material properties to these elements. However, when using automatic contact surfaces, linear elastic isotropic material properties need to be assigned.
4. For saving analysis time a one pass contact algorithm can be used. In this case only the penetration of the deformable surface into the rigid slideline surface is checked. To avoid the penetration of the rigid surface into the deformable surface use either the default two pass algorithm or a finer mesh on the deformable surface.

Recommendations on Use

These elements should be used when one of the surfaces which come into contact is non-deformable. Using these elements will make the analysis faster.

Chapter 14 :

Phreatic Elements

Phreatic Surface 2D Elements

General

Element Name PHS2

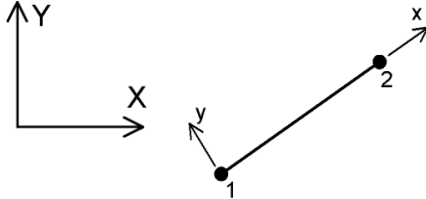

Element Group	Phreatic surface
Element Subgroup	2D Phreatic Surface
Element Description	2D Phreatic surface elements for defining phreatic surface
Number Of Nodes	2
Freedom Node	U, V at each node
Coordinates	X, Y at each node.

Geometric Properties

Not applicable.

Material Properties

Not applicable.

Loading

Prescribed Value	PDSP, TPDSP	Prescribed variable. U, V at each node.
Concentrated Loads	Not applicable.	
Element Loads	Not applicable.	
Distributed Loads	Not applicable.	
Body Forces	Not applicable.	
Velocities	VELO	Velocities. V_x , V_y at nodes.
Accelerations	ACCE	Acceleration A_x , A_y at nodes.
Viscous Support Loads	Not applicable.	
Initial	Not applicable.	

Stress/Strains	
Residual Stresses	Not applicable.
Temperatures	Not applicable.
Field Loads	Not applicable.
Temp Dependent Loads	Not applicable.

LUSAS Output

Not applicable.

Formulation

Geometric Nonlinearity

Not applicable.

Integration Schemes

Not applicable.

Mass Modelling

Not applicable.

Restrictions

Not applicable.

Notes on use

1. All the phreatic surface element nodes must be fully restrained.
2. There are no stress or strain calculations.
3. There is no need to assign geometric and material properties.
4. The phreatic surface elements are used with the Phreatic Surface load type and are used to define the location and extent of a phreatic surface.

Recommendations on Use

These elements are for use in geotechnical problems for the definition of the nodal pore-water pressures and hydrostatic loads.

Phreatic Surface 3D Elements

General

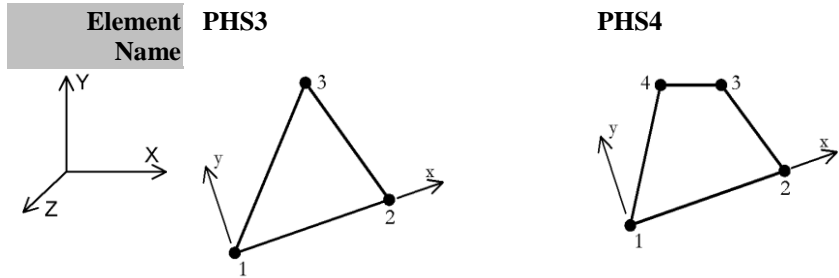

Element Group	Phreatic Surface
Element Subgroup	3D Phreatic Surface
Element Description	3D Phreatic surface elements for defining phreatic surface.
Number Of Nodes	3/4
Freedom Node Coordinates	U, V, W at each node. X, Y, Z at each node.

Geometric Properties

Not applicable.

Material Properties

Not applicable.

Loading

Velocities	VELO	Velocities. V_x , V_y , V_z at nodes.
Temperatures	Not applicable.	
Temp Dependent Loads	Not applicable.	
Residual Stresses	Not applicable.	
Prescribed Value	PDSP, TPDSP	Prescribed variable. U, V, W at each node.
Viscous Support Loads	Not applicable.	

Initial Stress/Strains	Not applicable.	
Field Loads	Not applicable.	
Element Loads	Not applicable.	
Distributed Loads	Not applicable.	
Concentrated Loads	Not applicable.	
Body Forces	Not applicable.	
Accelerations	ACCE	Acceleration Ax, Ay, Az at nodes.

LUSAS Output

Not applicable.

Formulation

Geometric Nonlinearity

Not applicable.

Integration Schemes

Not applicable.

Mass Modelling

Not applicable.

Restrictions

Not applicable.

Notes on use

1. All the phreatic surface element nodes must be fully restrained.
2. There are no stress or strain calculations.
3. There is no need to assign geometric and material properties.
4. The phreatic surface elements are used with the Phreatic Surface load type and are used to define the location and extent of a phreatic surface.

Recommendations on Use

These elements are for use in geotechnical problems for the definition of the nodal pore-water pressures and hydrostatic loads.

Appendix A : Element and Pressure Loads

ELDS Element Loads

These are referred to as Internal Beam Point Loads and Internal Beam Distributed Loads within LUSAS Modeller.

Parameter	Description
Itype	Element load type
S1, S2	Distances to specified loads
Px, Py, Pz	Point loads in local/global directions
Mx, My, Mz	Point moments in local/global directions
Wx, Wy, Wz	Distributed loads in local/global directions

Ityp e 11

Point loads and moments in local directions

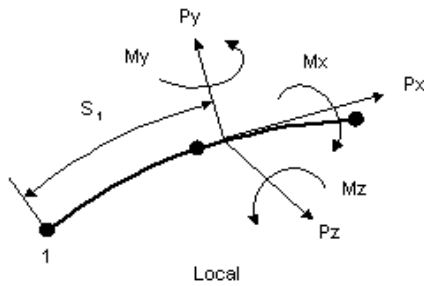

Ityp e 12

Point loads and moments in global directions

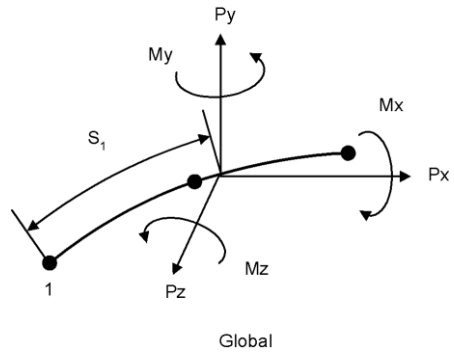

Ityp e 21

Uniformly distributed loads in local directions

W_x, W_y, W_z

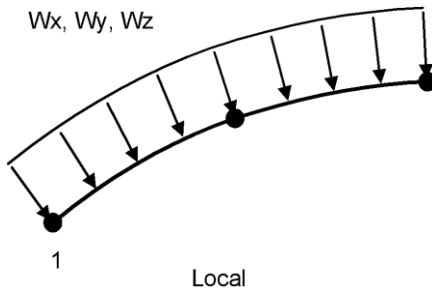

Ityp e 22

Uniformly distributed loads in global directions

W_x, W_y, W_z

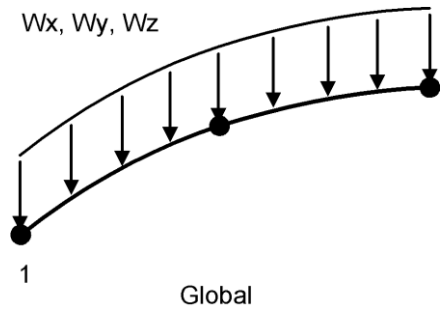

Ityp e 23

Uniformly distributed projected loads in global directions

W_x, W_y, W_z

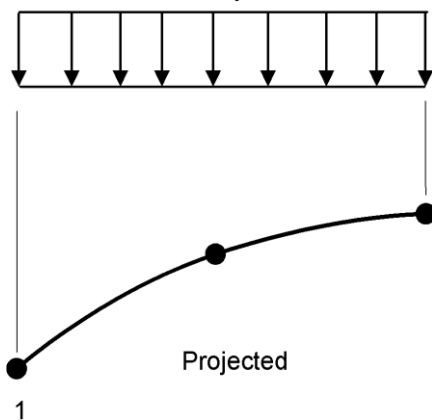

Ityp e 31

Distributed loads in local directions. Multiple load sets supported.

W_{x2}, W_{y2}, W_{z2}
 M_{x2}, M_{y2}, M_{z2}

W_{x1}, W_{y1}, W_{z1}
 M_{x1}, M_{y1}, M_{z1}

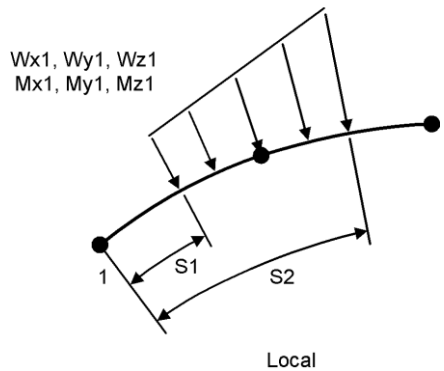

Ityp e 32

Ityp e 33

Distributed loads in global directions. Multiple load sets supported.

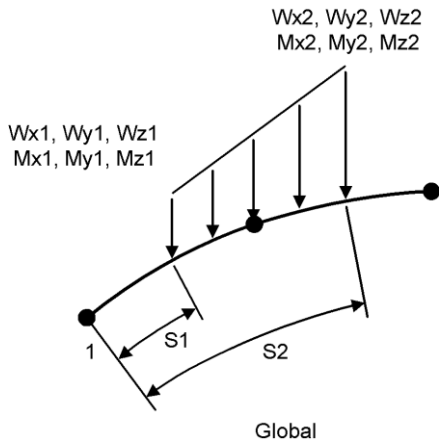

Distributed projected loads in global directions. Multiple load sets supported.

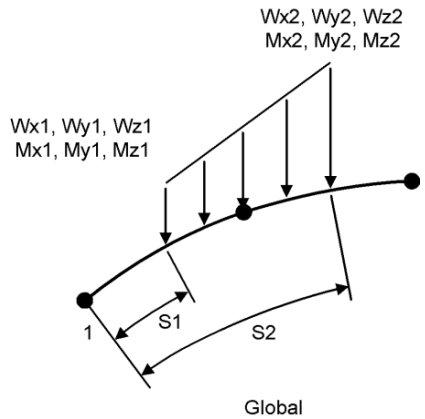

Itype 41

Trapezoidal loads in local directions

Definition only supported in LUSAS Solver. In LUSAS Modeller trapezoidal beam loads are defined in accordance with Itype 31.

W_x, W_y, W_z
 M_x, M_y, M_z

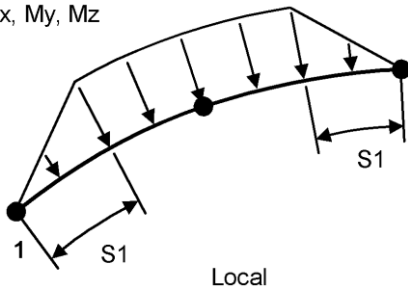

Itype 42

Trapezoidal loads in global directions

Definition only supported in LUSAS Solver. In LUSAS Modeller trapezoidal beam loads are defined in accordance with Itype 32.

W_x, W_y, W_z
 M_x, M_y, M_z

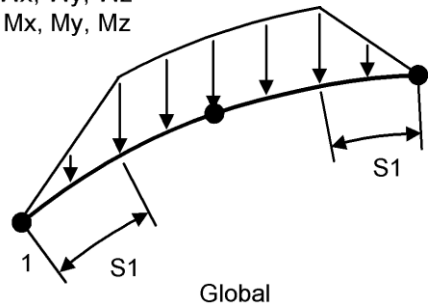

Itype 43

Trapezoidal projected loads in global directions

Definition only supported in LUSAS Solver. In LUSAS Modeller trapezoidal beam loads are defined in accordance with Itype 33.

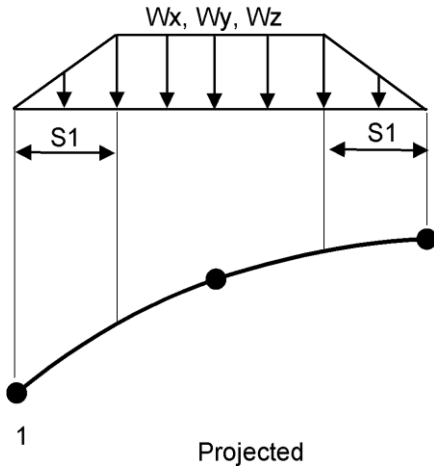

ENVT/TDET Environmental Boundary Conditions

Contains some or all of:

Parameter	Description
Tenv	External environmental temperature.
hc	Convective heat transfer coefficient.
RH	Radiative heat transfer coefficient.
hv	Vapour mass transfer coefficient.
T	Temperature for element.

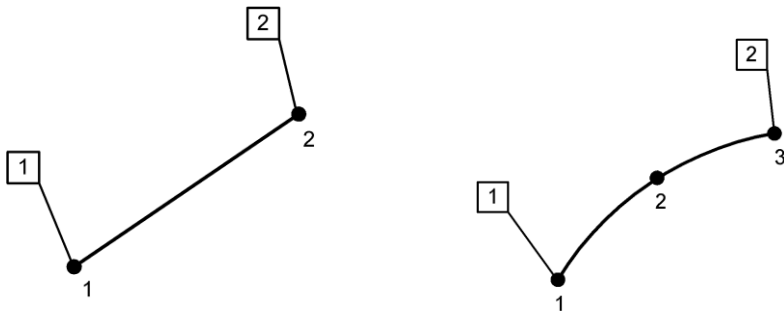

Face Numbering Convention for Thermal Bars

Note

The environmental temperature loading for node 2 cannot be specified for a 3 noded bar.

FLD Face loading applied to thermal bars

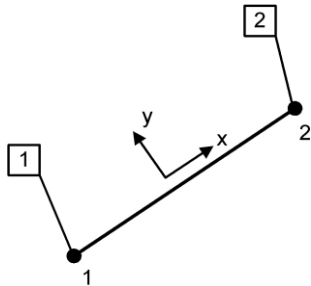

Face number = local node number

Face Numbering Convention for Thermal Bars

Face Loads On 2D Continuum Elements

Parameter	Description
P_x, P_y	Face pressures defined at nodes in local x, y directions

2-Noded Element Faces

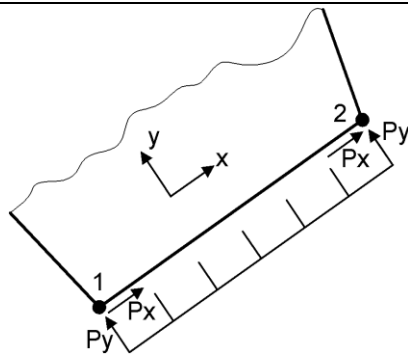

3-Noded Element Faces

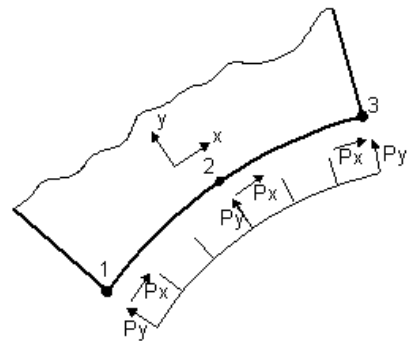

Notes

- In structural analysis note that the direction of the normal face load is not consistent between 2D and 3D continuum elements. For 2D continuum elements it is from the face towards the interior of the element. For 3D elements it is in the opposite direction - from the face of the element outwards.
- Face loads for explicit dynamics elements are constant, i.e. the average of the input nodal pressures

Face Numbering Convention

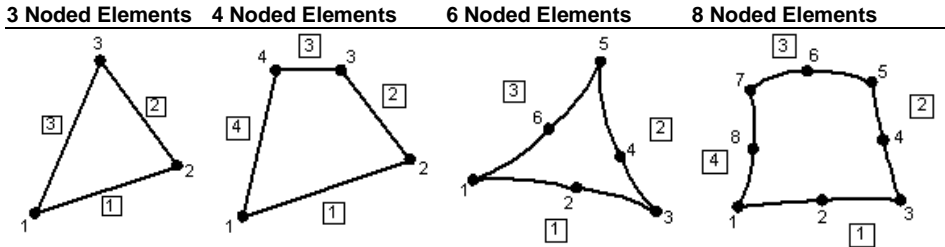

Face Loads On 3D Continuum Elements

Parameter	Description
Px, Py, Pz	Face pressures defined at nodes in local x, y directions acting positively in the local coordinate directions

Note

- In structural analysis note that the direction of the normal face load is not consistent between 2D and 3D continuum elements. For 2D continuum elements it is from the face towards the interior of the element. For 3D elements it is in the opposite direction - from the face of the element outwards.
- Face loads for explicit dynamics elements are constant, i.e. the average of the input nodal pressures.+

Local Face Coordinates

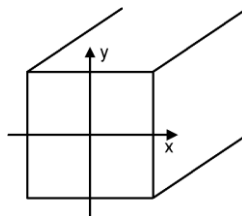

Face Numbering Convention

The following diagrams show exploded view of the various 3D elements. The grey faces show the element external faces that can be seen from a single perspective point, the white faces depict the internal faces from the same view point.

Notes

- The views of the internal faces show the x-axis direction from the inside. Take care when converting this to a view from the outside of the element.

4-Noded Tetrahedra

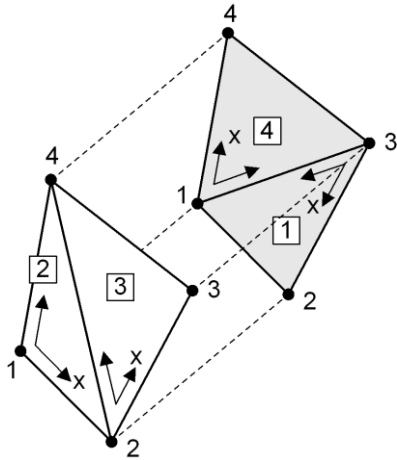

10-Noded Tetrahedra

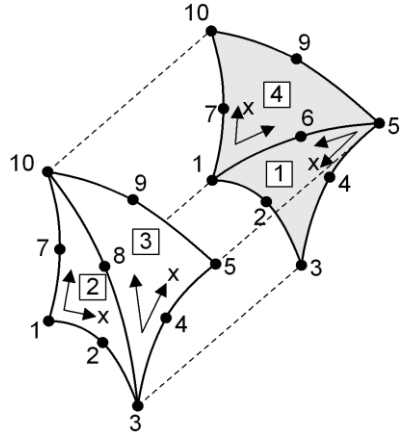

6-Noded Pentahedra

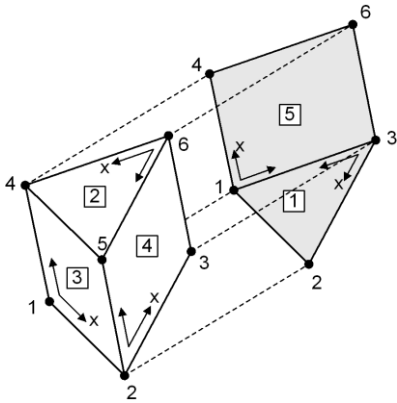

12-Noded Pentahedra

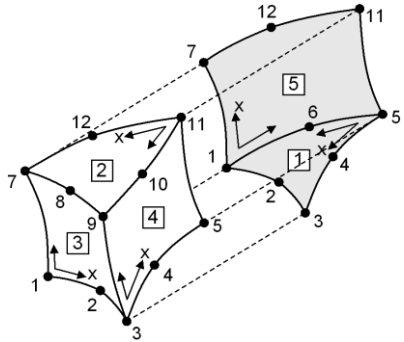

15-Node Pentahedra

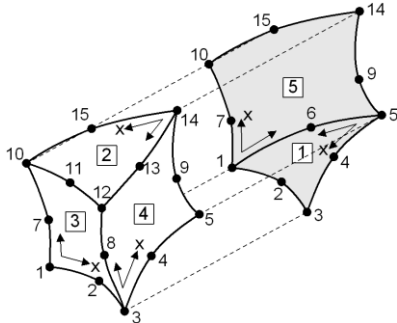

8-Noded Hexahedra

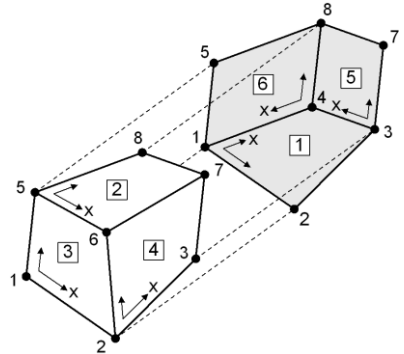

16-Noded Hexahedra

20-Noded Hexahedra

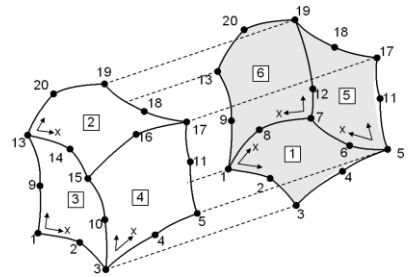
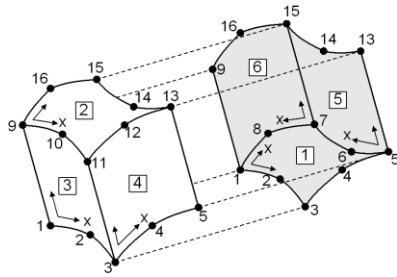

UDL Loads on Shells

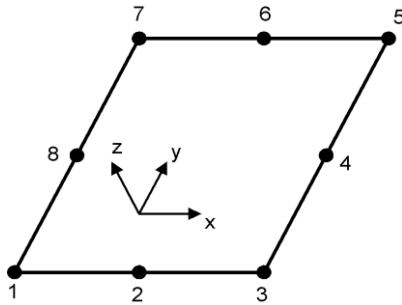

Appendix B :

Element

Restrictions

Mid-side Node Centrality

The mid-length node must be equidistant from the end nodes. Mid-side nodes may be automatically corrected for elements with global translational mid-side node freedoms using Option 49. The mid-side node is moved along the existing element edge until it is positioned centrally.

Excessive Element Curvature

Elements must not be excessively curved. A warning will be invoked (but the analysis will continue) if the element curvature is not in accordance with the following inequalities:

- i) $ABS (S1-S2) / (S1+S2) < 0.05$
- ii) $(S1+S2) / S3 < 1.02$

Where the function ABS returns the absolute value of the arguments.

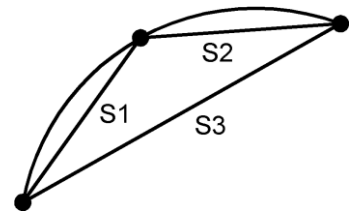

Excessive Aspect Ratios

An aspect ratio can be defined as the ratio of the longest to shortest element side lengths, such that:

- ❑ $R = \max (a/b, b/a)$ for surface elements (e.g. 2D continuum, plates and shells)
- ❑ $R = \max (a/b, b/a, c/a, c/b, \dots)$ for three dimensional solid elements

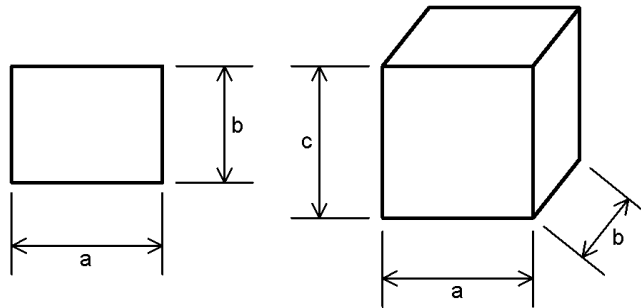

Elements must not have an excessive aspect ratio. A warning will be invoked (but the analysis will continue) if the element aspect ratio is greater than 10.

In general, severe distortion of an element will affect the accuracy of the stress distribution through an element. The type of stress field being imposed is also of importance, since a badly shaped element will still yield a good distribution in the presence of a constant uniaxial stress field, but not when subjected to a full stress field in which any of the components have a significant variation across the element.

The force equilibrium for the element will always be satisfied.

Excessive Warping

The four nodal points defining quadrilateral surface elements should be coplanar. However a small out of plane tolerance is permitted to allow a slightly warped shape according to

$$z < 0.01(L_{12})$$

where z is the out of plane distance of a node,

and L_{12} is the length between the first and second nodes.

If the above inequality is exceeded a warning will be issued but the analysis will proceed.

Appendix C : Local Element Axes

Standard Joint Element

Local x-axis The local x-axis is defined by the vector between the first and the third nodes of the element topology.

Note.

The third node must be different from nodes 1 and 2 of the topology.

Standard Line Element

Local x axis The local x-axis lies along the element in the direction in which the element nodes are defined. For curved elements the local x-axis is the tangent to the curve.

Local y axis The local xy plane is either defined by a dummy node and the two end nodes, or (in the absence of a dummy node), defined by the two end nodes and the central node. For the latter case, the local y-axis is perpendicular to the x-axis and on the positive convex side.

Local z axis The local z-axis forms a right-handed set with the local xy plane. For cross-section beams the top surface is defined by the local +ve z direction.

Note

Default line axes are defined in Modeller with the local x axis of the element following the line direction. The element local z is then defined in the XZ plane unless the local x axis is aligned to the global Z axis in which case the element local z axis is aligned with the global Y axis.

Standard Surface Element

Local x axis For 3 or 4 noded elements the local x-axis is defined by a line joining the first and second element nodes. For 6 and 8 noded elements the local x-axis is the tangent to the curve between the first 3 nodes.

Local y axis The local xy-plane is defined by the remaining nodes, the local y-axis being perpendicular to the x-axis and forming a right-handed set with the x-axis and the xy plane.

Local z-axis The local z-axis forms a right-handed set with the local x and y-axes. For shell elements the top surface is defined by the local +ve z direction.

Appendix D : Sign Conventions

The sign convention for forces, moments, stresses, rotations, eccentricities and potentials for different element types is documented in the following section headings.

Standard Bar Element

Axial force

(+ve) Axial tension

(-ve) Axial compression

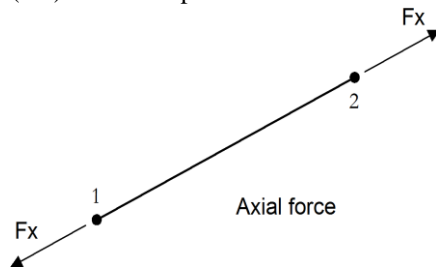

Standard Beam Element

Numerically Integrated Beam Elements

Axial force

(+ve) Axial tension

(-ve) Axial compression

Bending Moment

(+ve) Hogging moment (Top of beam in tension)

(-ve) Sagging moment (Bottom of beam in tension)

Note: *The top/bottom of the beam is determined by the element axes.*

Torsion

- (+ve) Rotation at 1st node greater than rotation at other end node
- (-ve) Rotation at 1st node smaller than rotation at other end node

Grillage Elements

End Forces and Rotations

Positive end forces and rotations for grillage elements are those acting on the element nodes in local directions, and are as follows:

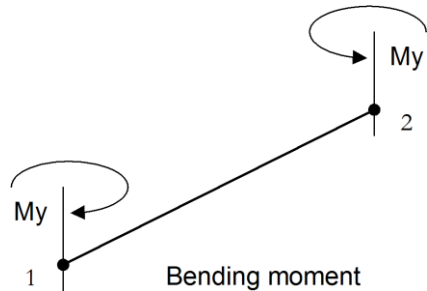
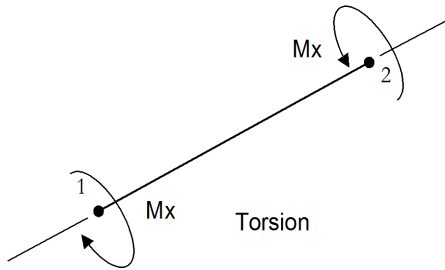
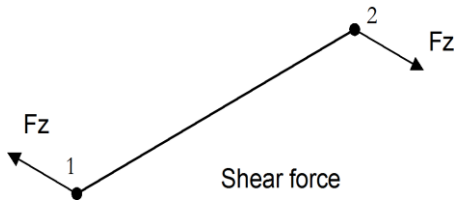
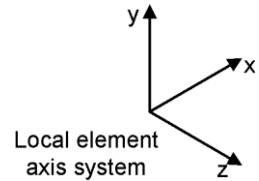

Note that when a reference path has been specified, additional force/moment components are available, and for this situation the x, y, and z element axes relate to longitudinal, transverse and vertical terms respectively. For instance M_y will relate to MF (longitudinal) - the flexural moment in longitudinal members that are following the path and MF (transverse) - the flexural moment in the transverse members that are orthogonal or skewed in relation to the reference path. Similarly, F_z will relate to FV (longitudinal) - the force in the vertical direction for longitudinal members that are following the path and FV (transverse) - the vertical direction for transverse members that are orthogonal or skewed in relation to the reference path.

Internal forces

These forces follow the sign convention for numerically integrated beams.

<u>Axial force</u>	<u>Bending Moment</u>	<u>Torsion</u>
Not	(+ve) Sagging	(+ve) Rotation at 1st node greater than rotation

applicable	moment	at other end node
	(-ve) Hogging moment	(-ve) Rotation at 1st node smaller than rotation at other end node

Sign convention in Modeller for bending moment

(+ve) Top of beam in tension

(-ve) Bottom of beam in tension

Where the top/bottom of the beam are determined by the element axes

See [numerically integrated beam sign convention.](#)

2D Engineering Beam Elements

End Forces and Rotations

Positive end forces and rotations for 2D engineering beams are those acting on the element nodes in local directions, and are as follows:

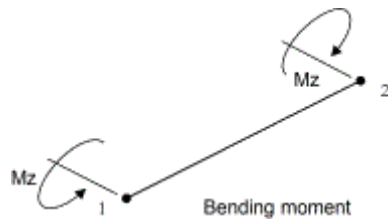
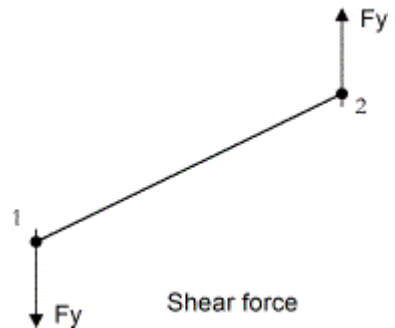
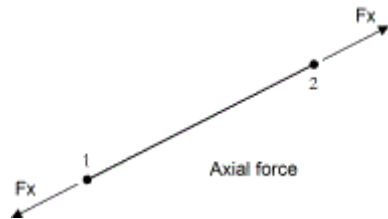
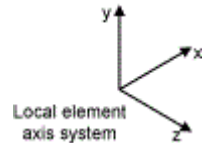

Internal forces

These forces follow the sign convention for numerically integrated beams.

Axial force

(+ve) Axial tension
(-ve) Axial compression

Bending Moment

(+ve) Hogging moment
(-ve) Sagging moment

Sign convention in Modeller for bending moment

(+ve) Top of beam in tension
(-ve) Bottom of beam in tension

Where the top/bottom of the beam are determined by the element axes

See [numerically integrated beam sign convention](#).

3D Engineering Beam Elements

End Forces and Rotations

Positive end forces and rotations for 3D engineering beams are those acting on the element nodes in local directions, and are as follows:

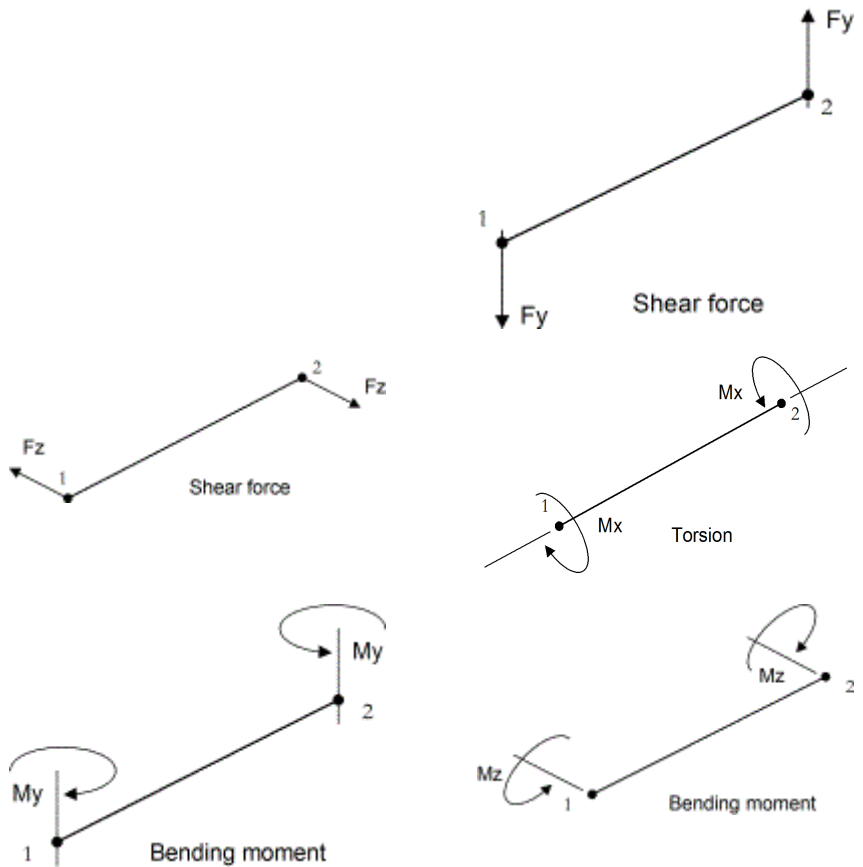
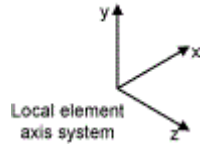

Internal forces

These forces follow the sign convention for numerically integrated beams.

<u>Axial force</u>	<u>Bending Moment</u>	<u>Torsion</u>
(+ve) Axial tension	(+ve) Hogging moment	(+ve) Rotation at 1st node greater than rotation at other end node
(-ve) Axial compression	(-ve) Sagging moment	(-ve) Rotation at 1st node smaller than rotation at other end node

Sign convention in Modeller for bending moment

- (+ve) Top of beam in tension
- (-ve) Bottom of beam in tension

Where the top/bottom of the beam are determined by the element axes

See [numerically integrated beam sign convention](#).

Standard Beam Eccentricities

Eccentricities are optional geometric properties for some elements and may be specified if the nodal line of the element does not lie along the required bending line/plane for the structural component being modelled.

Measurement of E_z (see diagram) is **from** the required bending plane (the beam xy plane) **to** the nodal line in the local element axis z-direction. If a beam xy plane is required such that it has negative local z coordinates relative to the nodal line, the eccentricity is positive.

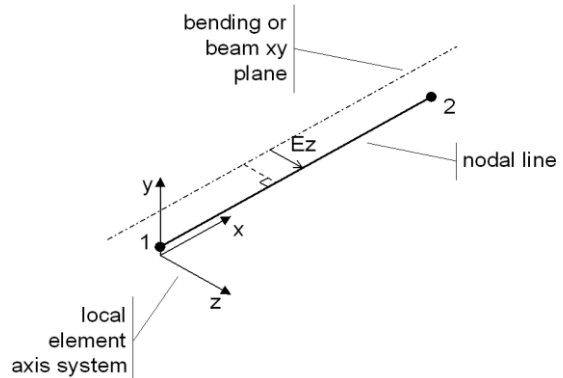

Similarly, measurement of E_y is **from** the required bending plane (the beam xz plane) **to** the nodal line in the local element axis y-direction. If a beam xz plane is required such that it has negative local y coordinates relative to the nodal line, the eccentricity is positive.

Standard 2D Continuum Element

Direct stress

- (+ve) Tension
- (-ve) Compression

Shear stress

- (+ve) Shear into XY quadrant
- (-ve) Shear into XY quadrant

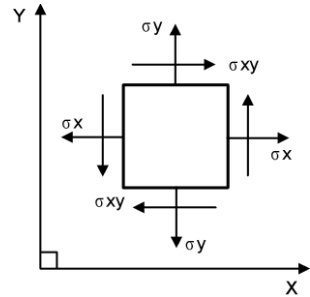

Note. Positive stress values are shown.

Standard 3D Continuum Element

Direct stress

- (+ve) Tension
- (-ve) Compression

Shear stress

- (+ve) Shear into XY, YZ and XZ quadrants
- (-ve) Shear into XY, YZ and XZ quadrants

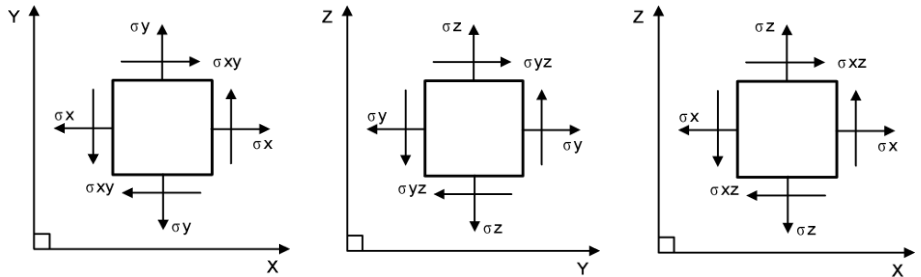

Note. Positive stress values shown.

Standard Plate Element

Flexural stress

- (+ve) Hogging moment (producing +ve stresses on the element top surface)
- (-ve) Sagging moment (producing -ve stresses on the element top surface)

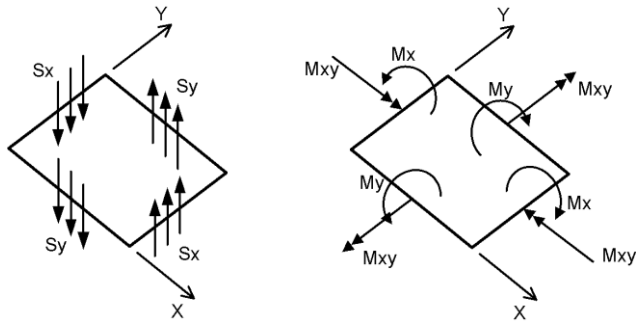

The +ve local z-direction defines the top surface.

Thin Shell Element

Membrane stress

- (+ve) Direct tension
- (-ve) Direct compression
- (+ve) In-plane shear into xy quadrant
- (-ve) In-plane shear into xy quadrant

Flexural stress

- (+ve) Hogging moment (producing +ve stresses on the element top surface)
- (-ve) Sagging moment (producing -ve stresses on the element top surface)

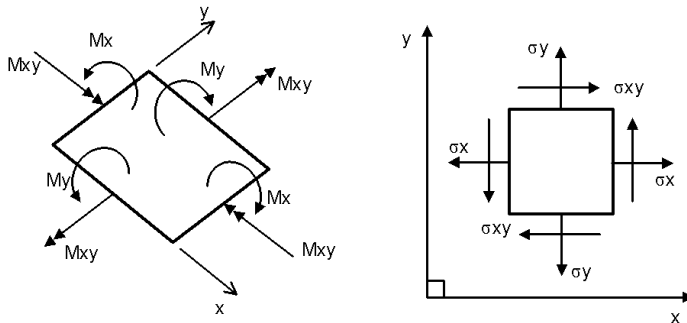

Notes

- Positive stress values shown.
- The +ve local z-direction defines the top surface.

Thin Shell Eccentricity

Eccentricity is an optional geometric property for this element type and may be specified if the nodal plane of the element does not lie along the required bending plane for the structural component being modelled.

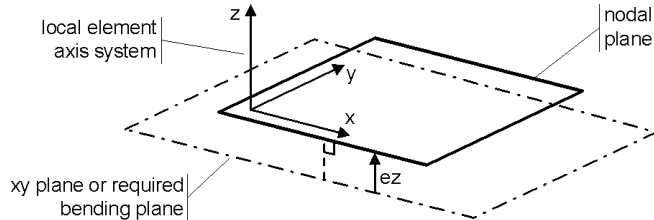

Measurement of e_z is **from** the required bending plane **to** the nodal plane in the local element axis z-direction.

Thick Shell Element

Thick shell stress (top, middle and bottom)

Direct stress (+ve) Tension
 (-ve) Compression

Shear stress (+ve) As shown in the following images
 (-ve) In the reverse directions in following images

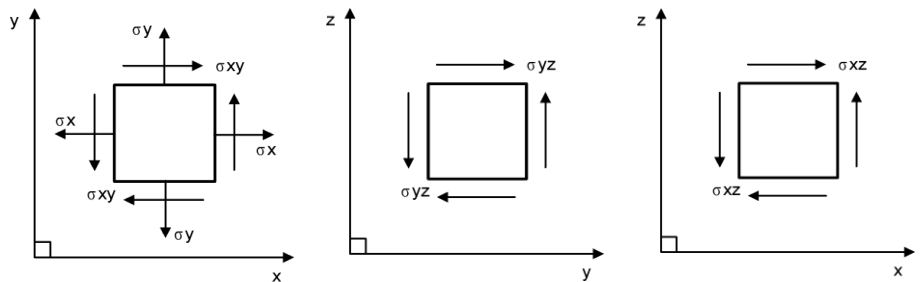

Stress Resultant

Membrane stress	(+ve)	Direct tension
	(-ve)	Direct compression
	(+ve)	In-plane shear into xy quadrant
	(-ve)	In-plane shear into xy quadrant
Flexural stress	(+ve)	Hogging moment (producing +ve stresses on the element top surface)
	(-ve)	Sagging moment (producing -ve stresses on the element top surface)

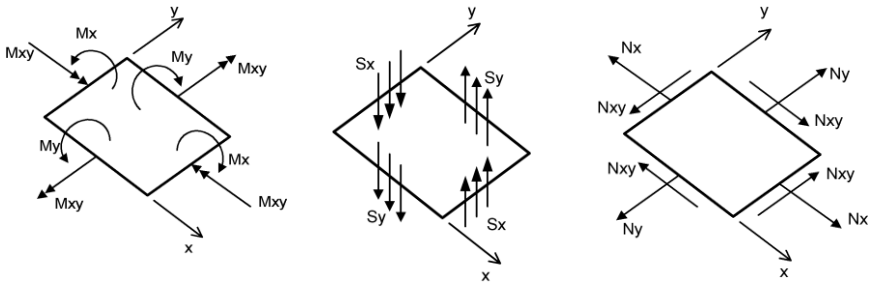

The +ve local z-direction defines the top surface.

Cylindrical local coordinate system

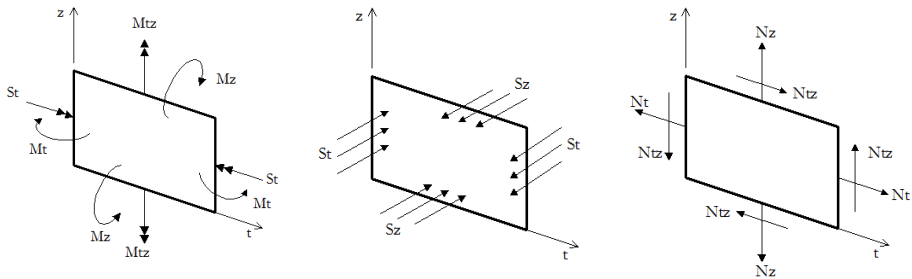

The cylindrical local coordinate systems above are based upon the following:

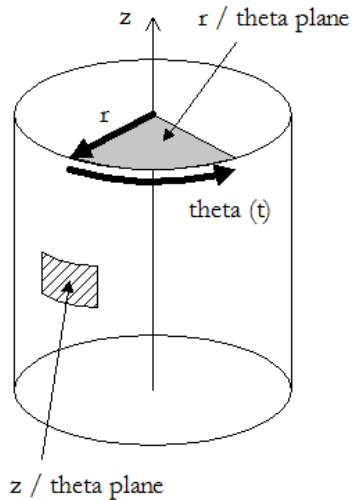

Thick Shell Eccentricity

Eccentricity is an optional geometric property for this element type and may be specified if the nodal plane of the element does not lie along the required bending plane for the structural component being modelled.

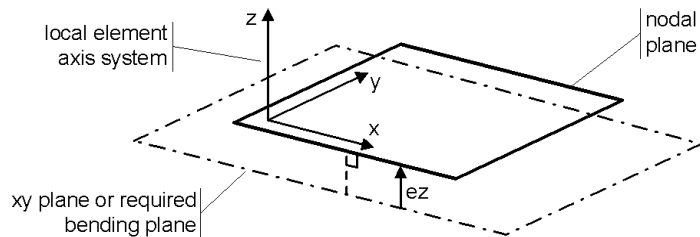

Measurement of e_z is **from** the required bending plane **to** the nodal plane in the local element axis z -direction.

Standard Membrane Element

Direct stress	(+ve)	Tension
	(-ve)	Compression
Shear stress	(+ve)	Shear into xy quadrant
	(-ve)	Shear into xy quadrant

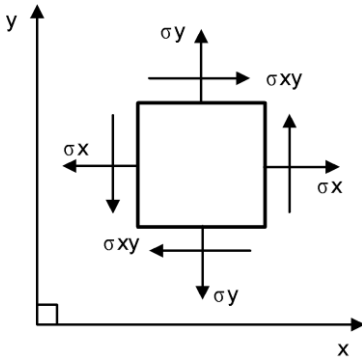

Standard Field Element

Potential

(+ve) +ve field value, dT/dx rate of change of field in x direction

Standard Joint Element

Direct force : (+ve) Tension and (-ve) Compression

Spring Moment : (+ve) for positive rotational spring strain and (-ve) for negative rotational spring strain

The sign of joint results is dependent upon both the element direction (that is which geometry is the master, and which is the slave) and the orientation of the local coordinate axes chosen.

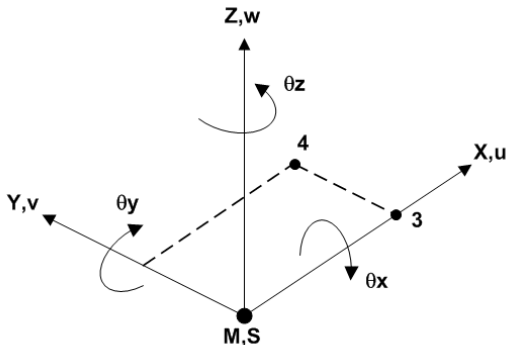

Coincident Master and Slave nodes, M = Master, S = Slave

Compression	Tension	Negative Moment	Positive Moment
$M_u > S_u$	$S_u > M_u$	$M_{\theta_x} > S_{\theta_x}$	$S_{\theta_x} > M_{\theta_x}$
$M_v > S_v$	$S_v > M_v$	$M_{\theta_y} > S_{\theta_y}$	$S_{\theta_y} > M_{\theta_y}$
$M_w > S_w$	$S_w > M_w$	$M_{\theta_z} > S_{\theta_z}$	$S_{\theta_z} > M_{\theta_z}$

Appendix E : Thick Shell Notation

Thick Shell Nodal Rotation

Problems with Singularities

In general, five degrees of freedom will be associated with each shell node: three translations and two rotations. The first axis of rotation will be defined by one of the global axes. The second axis of rotation is defined by the vector product of the selected global axis and the nodal normal.

Choosing one global axis to define the first rotation is not possible for all cases as singularities can occur depending on the orientation of the shell. As the topology of the shell cannot be known a means of choosing suitable rotations after the shell orientation has been defined must be provided.

How the Nodal Systems are Defined

The axis defining the θ_α rotation is chosen by examining the global components of the nodal normal. The smallest (absolute) component of the normal vector defines the global axis to be chosen as the first axis of rotation. The vector product of this axis and the nodal normal defines the axis for the second rotation θ_β . If the nodal normal coincides with the global Z axis, the global X axis will be chosen to define

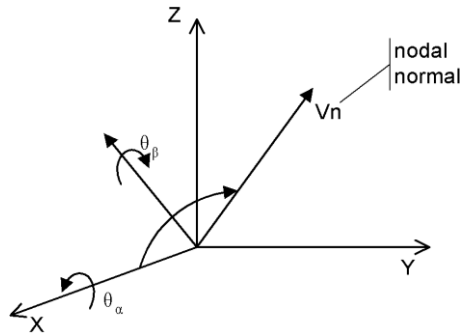

θ_α . In this instance, the X and Y components will both be minimum values. When two components define the same minimum value the order of priority for selection of the axis is X, Y, Z. Note that, in general, the axes of rotation and the nodal normal will form a non-orthogonal left-handed set. The rotations are indicated in the following figure where the global x axis has been used to define θ_α :

Five or Six Degrees of Freedom at a Node

LUSAS Solver will automatically select five degrees of freedom at a node, with rotations defined as above, unless:

- The maximum angle between the normals of adjacent elements meeting at the node is greater than 20 degrees. The value of 20 degrees is selected by default and may be changed using the SYSTEM parameter SHLANG.
- Beam, joint or other shell element types are connected to the node
- [Concentrated loads](#) or [support conditions](#) have been specified at the node using LUSAS Modeller
- Option 278 has been specified
- Six degrees of freedom have been selected for the node within the NODAL FREEDOMS data chapter. If six degrees of freedom are used at a node the rotations will relate to the global axes, θ_X , θ_Y and θ_Z unless TRANSFORMED FREEDOMS have been specified. It is recommended that the default value for SHLANG is retained wherever possible.

When are Six Degrees of Freedom Necessary?

Rotations relating to global axes will be required in the following circumstances:

- When a branched shell connection exists in the structure to be analysed. LUSAS Solver will automatically detect this and assign six degrees of freedom to nodes along the branch connection.

- ❑ When connecting with other element types. Six degrees of freedom will automatically be assigned to shell nodes connected to beams, joints or other shell element types.
- ❑ When boundary conditions or loading cannot be easily specified using the above definition of rotations, e.g. when applying moments or using symmetry.

If the rotations θ_α , θ_β will not allow the required loading or symmetry conditions to be applied, rotations about global axes may be enforced using NODAL FREEDOMS. The use of TRANSFORMED FREEDOMS will then allow the rotations to be related to a more convenient local orthogonal set if necessary. If six degrees of freedom at a node are enforced using NODAL FREEDOMS (i.e. not set automatically by LUSAS Solver) singularities may occur if the **in-plane rotation** (about the normal) **is not restrained**.

Appendix F :

Newton Coates

Integration

Newton-Cotes Integration Points

For beam elements BMX3, BSX4 and BXL4 the rigidity is computed by integration of the cross section. The default integration employs a 3x3 Newton Cotes rule for linear materials and a 5x5 rule for nonlinear materials. These may be altered by the user within the GEOMETRIC PROPERTIES definition. The locations of the default integration points are shown in the accompanying diagram, together with the local axes for the beam cross section (note the different corner numbering). The integration points are equally spaced along a particular natural ordinate for the section. The integration point numbers shown correspond with those given in the stress output for the element. More information on the cross sectional integration for these elements is available in the *LUSAS Theory Manual*.

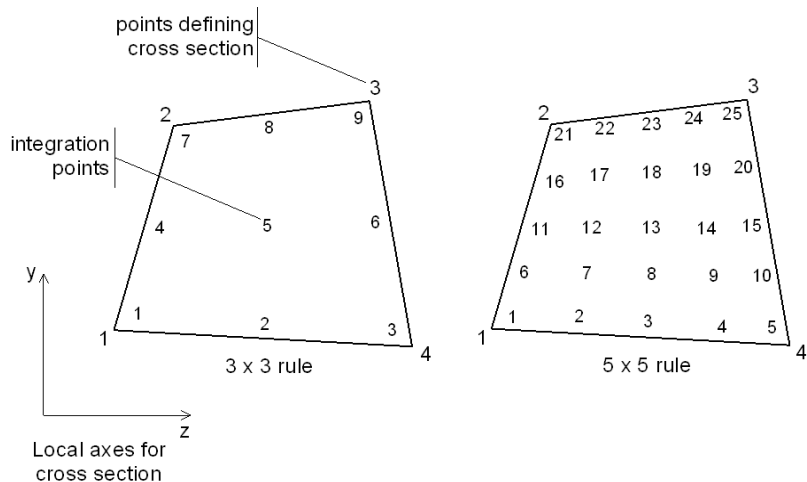

Newton-Cotes Integration Points for 3D Elements

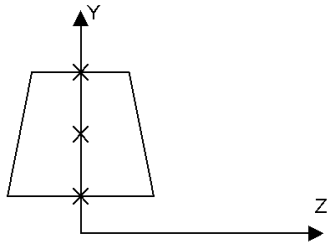

3-Point Newton-Coates

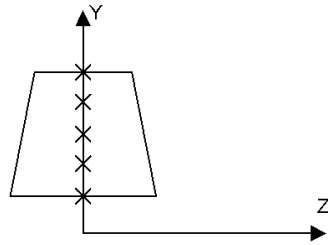

5-Point Newton-Coates

Newton-Cotes Integration Points for 2D Elements

Appendix G :

Shear Area and

Torsional

Constant

Shear Areas

In beams of small span to depth ratio, the shear stresses are likely to be high and the resulting deflection due to shear may not be negligible. The shear area is used to control the amount of shear deformation which will occur (A_{sz} , A_{sy}). For various sections, approximate values are as follows:

- Rectangular beams = $5A/6$
- I-beams (along web direction) = Area of web
- I-beams (along flange direction) = Area of flanges
- Thin walled, hollow circular section = $A/2$
- Solid circular section = $9A/10$
- No shear deformation = $1000A$

Note

- If A_{sz} or A_{sy} equal zero, mechanisms may occur.
- For elements which support this geometric input, shear deformation effects may be removed by assigning an artificially large value.
- The section property calculator in Modeller can be used to accurately compute shear areas

Torsional Constant

The torsional constant provides a measure of the torsional rigidity of a line member. Approximate values are as follows:

Solid circle

(equivalent to the polar moment of inertia)

$$\frac{\pi \cdot r^4}{2}$$

where r is the radius of the circle

Hollow circle

$$\frac{\pi}{2} (r_2^4 - r_1^4)$$

where r_2 is the outer radius

and r_1 is the inner radius

Solid square = $0.1406 a^4$

where a is the side length

Solid rectangle =

$$ab^3 \left[\frac{16}{3} - 3.36 \frac{b}{a} \left(1 - \frac{b^4}{12a^4} \right) \right]$$

where $2a$ is the length of the longest side

and $2b$ is the length of the shortest side

Equilateral triangle

$$\frac{a^4 \sqrt{3}}{80}$$

where a is the side length

Rectangular tube

$$\frac{2 \cdot t_1 \cdot t_2 \cdot (a - t_2)^2 (b - t_1)^2}{at_2 + bt_1 - t_2^2 - t_1^2}$$

where

a is the length of the longest side

t1 is the thickness of the longest side

b is the length of the shortest side

t2 is the thickness of the shortest side

Thin rectangle

$$\frac{1}{3} bt^3$$

where **b** is the rectangle length

and **t** is the rectangle length thickness

Any section consisting of thin rectangles

$$\frac{1}{3} \sum bt^3$$

Solid ellipse

$$\frac{\pi a^3 b^3}{a^2 + b^2}$$

where **2a** is the longest dimension

and **2b** is the shortest dimension

Note

- The section property calculator in Modeller can be used to accurately compute torsional constants

Appendix H :

Principal Stress

Output

Output Notation for Principal Stresses

For a bi-axial stress state, the Mohr's circle representation of a stress field is:

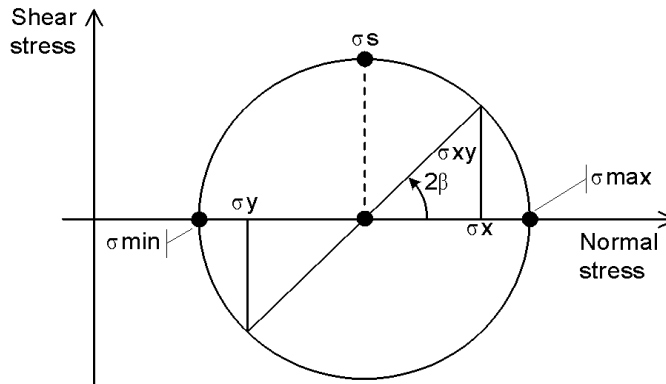

where:

σ_{max} is the maximum principal stress.

σ_{min} is the minimum principal stress

σ_s is the maximum shear stress

β defines the orientation of the principal axis (the plane on which the principal stresses act).

σ_x , σ_y , σ_{xy} represent an arbitrary two dimensional stress state.

Appendix I : Mass Lumping

Mass Lumping in LUSAS

Non-Structural mass elements are used to define a lumped mass at a point, or a distributed mass along a line and over a surface.

See *Non-Structural Mass Elements* in the *Modeller Reference Manual* for more details.

Appendix J :

Moments of

Inertia

Moments of Inertia Definitions

Second moment of area about line yy

$$I_{yy} = \int z^2 dA$$

Second moment of area about line zz

$$I_{zz} = \int y^2 dA$$

Product moment of inertia of section

$$I_{yz} = \int yz dA$$

(=0 for sections symmetric about **either** yy or zz)

First moment of area about yy

$$I_y = \int z dA$$

(=0 for sections symmetric about yy)

First moment of area about zz

$$I_z = \int y dA$$

(=0 for sections symmetric about zz)

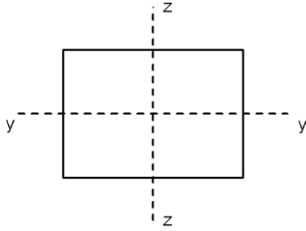

Note

- The above definitions are for a section defined in the two dimensional yz plane. Similar expressions apply for a section in the three dimensional space.
- For a beam with eccentricity e from the nodal line, then:

$$I_{zz} = Ae^2 + I_{na} \text{ and } I_z = eA$$

where I_{na} is the second moment of area about the centroidal axis.

- For the purpose of the moment inertia definitions above only, the eccentricity is measured **from the nodal line to the required bending plane** (the beam's xy plane in the figure above). For example, if a beam xy plane is required such that it has negative local z coordinates relative to the nodal line, the eccentricity to be used above is negative.

Appendix K :

Results Tables

Key to Element Results Tables

This section contains the notation for the results in the Results Tables. Some results are available in local and global directions depending on the element type. The case of the direction indicator associated for each term in the table will indicate its default direction for that element. Lower case indicates local element directions and upper case indicates that results are available in global directions by default.

Displacements

DX	Displacement in X direction	THL1	First loof rotation
DY	Displacement in Y direction	THL2	Second loof rotation
DZ	Displacement in Z direction	DU	Hierarchical disp. at mid-node
RSLT	Resultant displacement	DTHX	Hierarchical rotation at mid-node
THX	Rotation about X	PRES	Pore Pressure
THY	Rotation about Y	THw	Rate of change of twisting angle (warping beams)
THZ	Rotation about Z		

Note: Rotations are output in radians.

Velocities and Accelerations

VX	Velocity in X direction	AX	Acceleration in X direction
VY	Velocity in Y direction	AY	Acceleration in Y direction
VZ	Velocity in Z direction	AZ	Acceleration in Z direction
RSLT	Resultant velocity	RSLT	Resultant acceleration

VC Results calculator values

Strains

EX	Direct strain in X direction	Bx	Bending strain (curvature) about x axis
EY	Direct strain in Y direction	By	Bending strain (curvature) about y axis
EZ	Direct strain in Z direction	Bz	Bending strain (curvature) about z axis
EXY	Shear strain in XY plane	Bxy	Bending or torsional strain into xy plane
EYZ	Shear strain in YZ plane	Byz	Bending or torsional strain into yz plane
EZX	Shear strain in XZ plane	Bxz	Bending or torsional strain into xz plane
EMax	Maximum principal strain	BMax	Maximum principal bending strain
EMin	Minimum principal strain	BMin	Minimum principal bending strain
E1	Major principal strain	β	Angle between E1 and X axis
E2	Intermediate principal strain	EE	Equivalent strain (von Mises)
E3	Minor principal strain	EI	Maximum shear strain
Eabs	Signed largest value of principal strain	EV	Volumetric strain

Strains: Top/Middle/Bottom (TMB)

EX	Direct strain in X direction	E1	Major principal strain
EY	Direct strain in Y direction	E2	Intermediate principal strain
EZ	Direct strain in Z direction	E3	Minor principal strain
EXY	Shear strain in XY plane	Eabs	Signed largest value of principal strain
EYZ	Shear strain in YZ plane	β	Angle between E1 and X axis
EXZ	Shear strain in XZ plane	EE	Equivalent strain (von Mises)
		EI	Maximum shear strain

Plastic Strains

EPX	Plastic direct strain in X direction	EP1	Major principal strain
EPY	Plastic direct strain in Y direction	EP2	Intermediate principal plastic strain
EPZ	Plastic direct strain in Z	EP3	Minor principal plastic strain

	direction		
EPXY	Plastic shear strain in XY plane	EPabs	Signed largest value of principal plastic strain
EPYZ	Plastic shear strain in YZ plane	β	Angle between EP1 and X axis
EPZX	Plastic shear strain in ZX plane	EPE	Equivalent plastic strain (von Mises)
EPMax	Maximum principal plastic strain	EPI	Maximum shear strain
EPMin	Minimum principal plastic strain	CWMax	Maximum crack width
		EFSMax	Maximum equivalent fracture strain

Creep Strains

ECX	Creep direct strain in X direction	EC1	Major principal creep strain
ECY	Creep direct strain in Y direction	EC2	Intermediate principal creep strain
ECZ	Creep direct strain in Z direction	EC3	Minor principal creep strain
ECXY	Creep shear strain in XY plane	Ecabs	Signed largest value of principal creep strain
ECYZ	Creep shear strain in YZ plane	β	Angle between EC1 and X axis
ECZX	Creep shear strain in ZX plane	ECE	Equivalent creep strain (von Mises)
ECMax	Maximum principal creep strain	ECI	Maximum shear creep strain
ECMin	Minimum principal creep strain		

Rubber Stretches

StchX	Direct stretch tensor in X direction	Stch1	Major principal stretch
StchY	Direct stretch tensor in Y direction	Stch2	Intermediate principal stretch
StchZ	Direct stretch tensor in Z direction	Stch3	Minor principal stretch
StchXY	Shear stretch tensor in XY plane	StchAbs	Signed largest value of principal stretch
StchYZ	Shear stretch tensor in YZ plane	β	Angle between Stch1 and X axis

StchXZ	Shear stretch tensor in XZ plane	StchE	Equivalent stretch
StchMax	Maximum principal stretch	StchI	Maximum shear stretch
StchMin	Minimum principal stretch		

Strains: Interface Elements

Ex	Shear relative displacement in local x direction	Ez	Relative normal displacement in the local z (thickness) direction
Ey	Shear relative displacement in local y direction	dP	Pressure difference

Stresses: Continuum Elements

SX	Direct stress in global X direction	S1	Major principal stress
SY	Direct stress in global Y direction	S2	Intermediate principal stress
SZ	Direct stress in global Z direction	S3	Minor principal stress
SXY	Shear stress in Y-direction on a plane normal to X	Sabs	Signed largest value of principal stress
SYZ	Shear stress in yz plane	β	Angle between E1 and x axis
SXZ	Shear stress in xz plane	SI	Maximum shear stress
SMax	Maximum principal stress	SE	Equivalent stress (von Mises)
SMin	Minimum principal stress	Pres	Pore pressure

Force/Moment: Bar and Beam Elements

Fx	Force in local x direction	Mx	Moment about local x direction
Fy	Force in local y direction	My	Moment about local y direction
Fz	Force in local z direction	Mz	Moment about local z direction
Fb	Bi-shear or torque (warping)	Mb	Bi-moment (warping)

Stresses: Bar and Beam Elements

Sx(Fx)	Stress due to axial force in x	Sx(Fx, My)	Stress due to axial force and bending about y
Sx(My)	Stress due to bending about y	Sx(Fx, Mz)	Stress due to axial force and bending about y
Sx(Mz)	Stress due to bending about z	Sx(Fx, My, Mz)	Stress due to axial force and bending about y and z
Sx(My, Mz)	Stress due to bending about y and z		

Mz) about y and z

Force/Moment: Plate Elements (per unit width)

SX Shear force in global YZ plane	MX Moment in global X
SY Shear force in global XZ plane	MY Moment in global Y
	MAXY Twisting moment in global XY plane
	Mmax Major principal moment
	Mmin Minor principal moment
	β Angle between MMax and X axis
	MI Maximum shear moment
	Mabs Signed largest value of moment
	ME Equivalent moment

Force/Moment: Membrane and Shell Elements (per unit width)

Nx In-plane force in local x direction	Mx Moment in local x direction
Ny In-plane force in local y direction	My Moment in local y direction
Nxy In-plane shear force	Mxy Twisting moment in local xy plane
NMax Major principal in-plane force	Mmax Major principal moment
NMin Minor principal in-plane force	Mmin Minor principal moment
Nβeta Angle between NMax and x axis	Mβeta Angle between MMax and X axis
NI Maximum in-plane shear force	MI Maximum shear moment
NE Equiv stress resultant (von Mises)	ME Equivalent moment
Nabs Signed largest value of in-plane force	Mabs Signed largest value of moment
Sx Shear force in local yz plane	
Sy Shear force in local xz plane	

Stresses: Top/Middle/Bottom (TMB)

SX Direct stress in global X direction	S1 Major principal stress
SY Direct stress in global Y direction	S2 Intermediate principal stress
SZ Direct stress in global Z direction	S3 Minor principal stress

SXY	Shear stress in XY plane	Sabs	Signed largest value of principal stress
SYZ	Shear stress in YZ plane	SI	Maximum shear stress
SXZ	Shear stress in XZ plane	SE	Equivalent stress (von Mises)

Stresses: Interface Elements

Sx	Shear traction in local x direction	Sz	Normal stress in the local z (thickness) direction
Sy	Shear traction in local y direction	Q	Flow

Force/Moment: Wood-Armer (per unit width for Shells)

Mx(T)	Top surface local x moment	Nx(T)	Top surface local x force
My(T)	Top surface local y moment	Ny(T)	Top surface local y force
Mx(B)	Bottom surface local x moment	Nx(B)	Bottom surface local x force
My(B)	Bottom surface local y moment	Ny(B)	Bottom surface local y force
Util(T)	Top surface utilisation factor	Fc(T)	Top surface concrete force
Util(B)	Bottom surface utilisation factor	Fc(B)	Bottom surface concrete force
MUtil(T)	Top surface utilisation factor for bending only		
MUtil(B)	Bottom surface utilisation factor for bending only		

Force/Moment: Wood-Armer (per unit width for Plates and Grillages)

MX(T)	Top surface global X moment	MUtil(T)	Top surface utilisation factor for bending only
MY(T)	Top surface global Y moment	MUtil(B)	Bottom surface utilisation factor for bending only
MX(B)	Bottom surface global X moment		
MY(B)	Bottom surface global Y moment		

Additional Force/Moment Components

Note for influence analysis when a reference path has been specified, additional force/moment components are available for selection when transforming results. These are not listed for relevant elements in the Results tables.

FV	Force in Vertical direction	MF	Flexural Moment in
(longitudinal)	for longitudinal members that are following the reference path	(longitudinal)	longitudinal members that are following the reference path
FV	Force in Vertical direction	MF	Flexural Moment in
(transverse)	for transverse members that are orthogonal or skewed in relation to the reference path	(transverse)	transverse members that are orthogonal or skewed in relation to the reference path

Stresses: Interface Elements

Sx	Shear traction in local x direction	Sy	Shear traction in local y direction
Sz	Direct traction in the thickness direction		

Concrete Results

CWmax	Max Crack width	ESFmax	Max fracture strain
EPshk	Shrinkage strain	EPthm	Thermal strain
Temp	Temperature	Fcomp	Compressive strength
Ftens	tensile strength	Young	Young's modulus
ECX	Creep strain in global X	ECY	Creep strain in global Y
ECZ	Creep strain in global Z		

Potential

PHI	Field variable	PHIC	Results calculator values
T	Temperature		

Gradients

GX	Field gradient in X direction
GY	Field gradient in Y direction
GZ	Field gradient in Z direction

Fluxes

qX	Field flux in X direction
qY	Field flux in Y direction
qZ	Field flux in Z direction

Hygro-Thermal Results

SW	Water saturation	RoWC	Water content
PV	Vapour pressure	DH	Degree of hydration at day 28
Por	Porosity	TeffH	Effective time of hydration
TC	Thermal conductivity	PMD	Water permeability [m/s]
HR	Relative humidity of concrete		

Reactions / Residual Forces

FX	Force in X direction	MZ	Moment about Z axis
FY	Force in Y direction	FDU	Force due to hierarchical displacement
FZ	Force in Z direction	MDX	Moment due to hierarchical rotation
RSLT	Resultant force		
MX	Moment about X axis	QC	Flow at a point (field problems)
MY	Moment about Y axis	VFLW	Velocity of Flow

Reaction Stress

PX	Stress due to reaction in X direction	PZ	Stress due to reaction in Z direction
PY	Stress due to reaction in Y direction		

Fatigue Parameters

Damage	A measure of damage	LogLife	Log repeats to failure
---------------	---------------------	----------------	------------------------

Note. The fatigue facility uses Miner's rule, that is:

$$n1/N1 + n2/N2 + \dots + ni/Ni = \text{Damage}$$

where *Damage* is the damage variable and is usually taken as unity (experiment usually gives values between 0.7 and 2.2). *ni* is the number of cycles of stress applied to the structure and *Ni* is the life corresponding to the stress. *Loglife* is the log (base 10) of the life expectancy of the structure according to the loading and the number of cycles specified. Life is measured in terms of cycles.

Damage Parameters

DDAMA	Damage variable	DAMAM	Damage consistency parameter
CCURD	Damage threshold	DFUNC	Damage function

Note. Damage parameters are only available when a damage model is in use.

Strain Energy and Plastic Work

SED Strain energy density (StEngD) **PWD** Plastic work density

Note. Strain energy density and plastic work density values can be accessed if turned on by selecting **Calculate Strain Energy and Plastic Work Densities** from the **Results > Options** dialog or by using the command: **SET RESULTS ENERGY**.

Adaptive Error

Eadp Adaptive error.

Note. Adaptive error results are only available when an adaptive results column is set. See the *LUSAS User Manual* for more details.

State Variables

State variables can be accessed with the command:

```
SET RESULTS STATE_VARIABLES istvb nsvcmp isvloc
```

Where *istvb* is the type of state variable required, *nsvcmp* is the number of state variables required, and *isvloc* is the start location of the first state variable required.

The results columns for these state variables vary according to the results type set. The column descriptors have the following prefixes:

- PL** Plastic, Rubber
- CR** Creep
- DM** Damage

- followed by the number of the state variable required. For example, if four creep state variables are required, the column descriptors will be CR1, CR2, CR3 and CR4.

Key to Slideline Results Components

This section contains the notation for slideline results. Note that slideline results components are not listed in the results tables.

TanGapFrcx	Tangential gap force in local x direction	NrmPen	Penetration normal to contact surface
TanGapFrcy	Tangential gap force in local y direction	ContStatus	In-contact/out-of-contact status
RsltTanGFc	Resultant tangential gap force	ContacArea	Nodal contact area
NrmGapForc	Gap force normal to contact surface	Contact	In-contact/out-of-contact status
ForceX	Contact force in system x direction	Zone	Zonal contact parameter
ForceY	Contact force in system y direction	ZnCnDetDst	Zonal contact detection distance
ForceZ	Contact force in system z	IntStfCoef	Contact stiffness

	direction		coefficient
RsltForce	Resultant contact force	TanForce_x	Tangential contact force in local x direction
ContStress_x	Contact stress in local x direction	TanForce_y	Tangential contact force in local y direction
ContStress_y	Contact stress in local y direction	RsltTanFrc	Resultant tangential contact force
ContPress	Contact pressure normal to contact surface	NrmForce	Contact force normal to contact surface
ContStiff	Contact stiffness		

Transforming Results Directions

Important: Some results entities can be transformed. The results components will use alternative suffixes if results are calculated relative to a system other than the global axis set. The element results tables show the default results directions for all elements with lower case subscripts being used for local results.

See the [Local and Global Results](#) in the *LUSAS Modeller User Manual* for details of results transformation procedures.

2D Structural Bars BAR2, BAR3

Entity	Component										
Displacement	DX	DY	RSLT								
Force/Moment	FX	Fabs	Damage	LogLife	DDAMA	CURRD	DAMAM	DFUNC	SED	PWD	Eadp
Strain	EX	Eabs	DDAMA	CURRD	DAMAM	DFUNC	SED	PWD	Eadp		
(continued)	DDAMA	CURRD	DAMAM	DFUNC	SED	PWD	Eadp				
Loading	FX	FY	RSLT								
Reaction	FX	FY	RSLT								
Residual Force	FX	FY	RSLT								
Reaction Stress											
Velocity	VX	VY	RSLT								
Acceleration	AX	AY	RSLT								
Plastic Strain	EPX	EPabs	DDAMA	CURRD	DAMAM	DFUNC	SED	PWD	Eadp		
Creep Strain	ECX	ECabs	DDAMA	CURRD	DAMAM	DFUNC	SED	PWD	Eadp		
Rubber Stretches											
TMB Stress											
TMB Strain											
TMB Plastic Strain											
TMB Creep Strain											

3D Structural Bars [BRS2](#), [BRS3](#)

Entity	Component										
Displacement	DX	DY	DZ	RSLT							
Force/Moment	FX	Fabs	Damage	LogLife	DDAMA	CURRD	DAMAM	DFUNC	SED	PWD	Eadp
Strain	EX	Eabs	DDAMA	CURRD	DAMAM	DFUNC	SED	PWD	Eadp		
(continued)	DDAMA	CURRD	DAMAM	DFUNC	SED	PWD	Eadp				
Loading	FX	FY	FZ	RSLT							
Reaction	FX	FY	FZ	RSLT							
Residual Force	FX	FY	FZ	RSLT							
Reaction Stress											
Velocity	VX	VY	VZ	RSLT							
Acceleration	AX	AY	AZ	RSLT							
Plastic Strain	EPX	EPabs	DDAMA	CURRD	DAMAM	DFUNC	SED	PWD	Eadp		
Creep Strain	ECX	ECabs	DDAMA	CURRD	DAMAM	DFUNC	SED	PWD	Eadp		
Rubber Stretches											
TMB Stress											
TMB Strain											
TMB Plastic Strain											
TMB Creep Strain											

2D Engineering Grillage Thick Beam GRIL

Entity	Component												
Displacement	DZ	RSLT	THX	THY									
Force/Moment	Fz	Mx	My	Mx(T)	My(T)	Mx(B)	My(B)	Util(T)	Util(B)	Damage	LogLife	SED	Eadp
Strain													
Loading	FZ	RSLT	MX	MY									
Reaction	FZ	RSLT	MX	MY									
Residual Force													
Reaction Stress													
Velocity	VZ	RSLT											
Acceleration	AZ	RSLT											
Plastic Strain													
Creep Strain													
Rubber Stretches													
TMB Stress													
TMB Strain													
TMB Plastic Strain													
TMB Creep Strain													

Note: Wood-Armer results are only available for plotting /printing at nodes. They are not available unaveraged at nodes within elements or at Gauss points.

2D Thick Beam Elements [BMI2](#), [BMI3](#), [BMI2X](#), [BMI3X](#)

Entity	Component											
Displacement	DX	DY	RSLT	THZ								
Force/Moment	Fx	My	Mz	Damage	LogLife	DDAMA	CURRD	DAMAM	DFUNC	SED	PWD	Eadp
Strain	Ex	Exy	Bz	DDAMA	CURRD	DAMAM	DFUNC	SED	PWD	Eadp		
Loading	FX	FY	RSLT	MZ								
Reaction	FX	FY	RSLT	MZ								
Residual Force	FX	FY	RSLT	MZ								
Reaction Stress												
Velocity	VX	VY	RSLT									
Acceleration	AX	AY	RSLT									
Plastic Strain	EPx	EPxy	DDAMA	CURRD	DAMAM	DFUNC	SED	PWD	Eadp			
Creep Strain	ECx	ECxy	DDAMA	CURRD	DAMAM	DFUNC	SED	PWD	Eadp			
Rubber Stretches	Sx	Sy										
TMB Stress	Ex	Exy										
TMB Strain	EPx	EPxy										
TMB Plastic Strain	ECx	ECxy										

Note: Plastic and creep strains are only available for BMI2X and BMI3X elements with the appropriate material models.

3D Thick Beam Elements [BMI21](#), [BMI22](#), [BMI31](#), [BMI33](#), [BMX21](#), [BMX22](#), [BMX31](#), [BMX33](#)

Entity	Component														
Displacement	DX	DY	DZ	RSLT	THX	THY	THZ								
Force/Moment	Fx	My	Mz	Mx	My	Mz	Damage	LogLife	DDAMA	CURRD	DAMAM	DFUNC	SED	PWD	Eadp
Strain	Ex	By	Bz	Bx	By	Bz	DDAMA	CURRD	DAMAM	DFUNC	SED	PWD	Eadp		
Loading	FX	FY	FZ	RSLT	MX	MY	MZ								
Reaction	FX	FY	FZ	RSLT	MX	MY	MZ								
Residual Force	FX	FY	FZ	RSLT	MX	MY	MZ								
Reaction Stress															
Velocity	VX	VY	VZ	RSLT											
Acceleration	AX	AY	AZ	RSLT											
Plastic Strain	EPx	EPxy	EPzx	DDAMA	CURRD	DAMAM	DFUNC	SED	PWD	Eadp					
Creep Strain	ECx	ECxy	ECzx	DDAMA	CURRD	DAMAM	DFUNC	SED	PWD	Eadp					
Rubber Stretches															
TMB Stress															
TMB Strain															
TMB Plastic Strain															

Note: Plastic and creep strains are only available for BMX21, BMX31, BMX22, BMX33 elements with the appropriate material models.

3D Thick Beam Elements with Torsional Warping

BMI21W, **BMI22W**, **BMI31W**, **BMI33W**,
BMX21W, **BMX22W**, **BMX31W**, **BMX33W**

Entity	Component																
Displacement	DX	DY	DZ	RSLT	THX	THY	THZ	THw									
Force/Moment	Fx	My	Mz	Mx	My	Mz	Fb	Mb	Damage	LogLife	DDAMA	CURRD	DAMAM	DFUNC	SED	PWD	Eadp
Strain	Ex	By	Bz	Bx	By	Bz	Efb	Emb	DDAMA	CURRD	DAMAM	DFUNC	SED	PWD	Eadp		
Loading	FX	FY	FZ	RSLT	MX	MY	MZ										
Reaction	FX	FY	FZ	RSLT	MX	MY	MZ	Mw									
Residual Force	FX	FY	FZ	RSLT	MX	MY	MZ										
Reaction Stress																	
Velocity	VX	VY	VZ	RSLT													
Acceleration	AX	AY	AZ	RSLT													
Plastic Strain	EPx	EPxy	EPzx	DDAMA	CURRD	DAMAM	DFUNC	SED	PWD	Eadp							
Creep Strain	ECx	ECxy	ECzx	DDAMA	CURRD	DAMAM	DFUNC	SED	PWD	Eadp							
Rubber Stretches																	
TMB Stress																	
TMB Strain																	
TMB Plastic Strain																	

Note: Plastic and creep strains are only available for BMX21W, BMX31W, BMX22W, BMX33W elements with the appropriate material models.

2D Kirchhoff Thin Beams **BM3**, **BMX3**

Entity	Component											
Displacement	DX	DY	RSLT	THZ	DU							
Force/Moment	Fx	Fy	Mz	Damage	LogLife	DDAMA	CURRD	DAMAM	DFUNC	SED	PWD	Eadp
Strain	Ex	Ey	Bz	DDAMA	CURRD	DAMAM	DFUNC	SED	PWD	Eadp		
Loading	FX	FY	RSLT	MZ	FDU							
Reaction	FX	FY	RSLT	MZ	FDU							
Residual Force	FX	FY	RSLT	MZ	FDU							
Reaction Stress												
Velocity	VX	VY	RSLT									
Acceleration	AX	AY	RSLT									
Plastic Strain	EPx	DDAMA	CURRD	DAMAM	DFUNC	SED	PWD	Eadp				
Creep Strain	ECx	DDAMA	CURRD	DAMAM	DFUNC	SED	PWD	Eadp				
Rubber Stretches												
TMB Stress												
TMB Strain												
TMB Plastic Strain												
TMB Creep Strain												

Note: Plastic and creep strains are only available for BMX3 elements with the appropriate material models.

3D Kirchhoff Thin Beams BS3, BS4, BSX4

Entity	Component														
Displacement	DX	DY	DZ	RSLT	THX	THY	THZ	DU	DTHX						
Force/Moment	Fx	My	Mz	Tzx	Txy	Fy	Fz	Damage	LogLife	DDAMA	CURRD	DAMAM	DFUNC	SED	PWD
(continued)	Eadp														
Strain	Ex	By	Bz	Bzx	Bxy	Ey	Ez								
(continued)	Eadp														
Loading	FX	FY	FZ	RSLT	MX	MY	MZ	FDU	MDX						
Reaction	FX	FY	FZ	RSLT	MX	MY	MZ	FDU	MDX						
Residual Force	FX	FY	FZ	RSLT	MX	MY	MZ	FDU	MDX						
Reaction Stress															
Velocity	VX	VY	VZ	RSLT											
Acceleration	AX	AY	AZ	RSLT											
Plastic Strain	EPx	EPxy	EPzx	EPyz	DDAMA	CURRD	DAMAM	DFUNC	SED	PWD	Eadp				
Creep Strain	ECx	ECxy	ECzx	ECyz	DDAMA	CURRD	DAMAM	DFUNC	SED	PWD	Eadp				
Rubber Stretches															
TMB Stress															
TMB Strain															
TMB Plastic Strain															
TMB Creep Strain															

Note: Plastic and creep strains are only available for BSX4 elements with the appropriate material models.

3D Semiloof Thin Beams BSL3, BSL4, BXL4

Entity	Component														
Displacement	DX	DY	DZ	RSLT	THX	THY	THZ	THL1	THL2						
Force.Moment	Fx	My	Mz	Tzx	Txy	Fy	Fz	Damage	LogLife	DDAMA	CURRD	DAMAM	DFUNC	SED	PWD
(continued)	Eadp														
Strain	Ex	By	Bz	Bzx	Bxy	Ey	Ez	DDAMA	CURRD	DAMAM	DFUNC	SED	PWD	Eadp	
Loading	FX	FY	FZ	RSLT	MX	MY	MZ	ML1	ML2						
Reaction	FX	FY	FZ	RSLT	MX	MY	MZ	ML1	ML2						
Residual Force	FX	FY	FZ	RSLT	MX	MY	MZ	ML1	ML2						
Reaction Stress															
Velocity	VX	VY	VZ	RSLT											
Acceleration	AX	AY	AZ	RSLT											
Plastic Strain	EPx	EPxy	EPyz	EPzx	DDAMA	CURRD	DAMAM	DFUNC	SED	PWD	Eadp				
Creep Strain	ECx	ECxy	ECyz	ECzx	DDAMA	CURRD	DAMAM	DFUNC	SED	PWD	Eadp				
Rubber Stretches															
TMB Stress															
TMB Strain															
TMB Plastic Strain															
TMB Creep Strain															

Note: Plastic and creep strains are only available for BXL4 elements with the appropriate material models.

Plane Strain Beam Elements **BMI2N**, **BMI3N**

Entity	Component										
Displacement	DX	DY	RSLT	THZ							
Stress	Nx	Nz	Mx	Mz	Nxy	NMax	NMin	Ns	β	Nabs	Ne
(continued)	Damage	LogLife	DDAMA	CURRD	DAMAM	DFUNC	SED	PWD	Eadp		
Strain	Ex	Ez	Bx	Bz	Exy	EMax	EMin	EI	β	Eabs	EE
(continued)	DDAMA	CURRD	DAMAM	DFUNC	SED	PWD	Eadp				
Loading	FX	FY	RSLT	MZ							
Reaction	FX	FY	RSLT	MZ							
Residual Force	FX	FY	RSLT	MZ							
Reaction Stress	PX	PY									
Velocity	VX	VY	RSLT								
Acceleration	AX	AY									
Plastic Strain											
Creep Strain											
Rubber Stretches											
TMB Stress	Sx	Sz	Sxy	SMax	Smin	SI	β	Sabs	SE		
(continued)	Damage	LogLife	DDAMA	CURRD	DAMAM	DFUNC	SED	PWD	Eadp		
TMB Strain	Ex	Ez	Exy	EPmax	EMin	EI	β	Eabs	ECE		
(continued)	DDAMA	CURRD	DAMAM	DFUNC	SED	PWD	Eadp				
TMB Plastic Strain	EPx	EPz	EPxy	EPMax	EPMin	EPI	β	EPabs	ECE		
(continued)	DDAMA	CURRD	DAMAM	DFUNC	SED	PWD	Eadp				
TMB Creep Strain	ECx	ECz	ECxy	ECMax	ECMin	ECl	β	ECabs	ECE		
(continued)	DDAMA	CURRD	DAMAM	DFUNC	SED	PWD	Eadp				

**2D Continuum (Plane Stress) TPM3/6, QPM4/8, QPM4M,
TPK6, QPK8**

Entity	Component											
Displacement	DX	DY	RSLT									
Stress	SX	SY	SXY	SMax	SMin	SI	β	Sabs	SE			
(continued)	Damage	LogLife	DDAMA	CURRD	DAMAM	DFUNC	SED	PWD	Eadp			
Strain	EX	EY	EXY	EMax	EMin	EI	β	Eabs	EE			
(continued)	DDAMA	CURRD	DAMAM	DFUNC	SED	PWD	Eadp					
Loading	FX	FY	RSLT									
Reaction	FX	FY	RSLT									
Residual Force	FX	FY	RSLT									
Reaction Stress	PX	PY										
Velocity	VX	VY	RSLT									
Acceleration	AX	AY	RSLT									
Plastic Strain	EPX	EPY	EPXY	EPMMax	EPMIn	EPI	β	EPabs	EPE	CWMax	EFSMax	
(continued)	DDAMA	CURRD	DAMAM	DFUNC	SED	PWD	Eadp					
Creep Strain	ECX	ECY	ECXY	ECMax	ECMin	ECl	β	ECabs	ECE			
(continued)	DDAMA	CURRD	DAMAM	DFUNC	SED	PWD	Eadp					
Rubber Stretches	StchX	StchY	StchXY	StchMax	StchMin	Stchl	β	StchAbs	StchE			
(continued)	DDAMA	CURRD	DAMAM	DFUNC	SED	PWD	Eadp					
TMB Stress												
TMB Strain												
TMB Plastic Strain												
TMB Creep Strain												

Notes:

Rubber stretches are only available for QPM4M elements with rubber material models. Strains are not available for this element when using rubber materials.

Plastic strain components CWMax and EFSMax are only available when the Smoothed Multi-crack Concrete Models (105 and 109) are used.

2D Continuum Plane Stress (Explicit Dynamics)

TPM3E, QPM4E

Entity	Component								
Displacement	DX	DY	RSLT						
Stress	SX	SY	SXY	SMax	SMin	SI	β	Sabs	SE
(continued)	Damage	LogLife	DDAMA	CURRD	DAMAM	DFUNC	SED	PWD	Eadp
Strain	EX	EY	EXY	EMax	EMin	EI	β	Eabs	EE
(continued)	DDAMA	CURRD	DAMAM	DFUNC	SED	PWD	Eadp		
Loading	FX	FY	RSLT						
Reaction	FX	FY	RSLT						
Residual Force	FX	FY	RSLT						
Reaction Stress	PX	PY							
Velocity	VX	VY	RSLT						
Acceleration	AX	AY	RSLT						
Plastic Strain	EPX	EPY	EPXY	EPMMax	EPMMin	EPI	β	EPabs	EPE
(continued)	DDAMA	CURRD	DAMAM	DFUNC	SED	PWD	Eadp		
Creep Strain	ECX	ECY	ECXY	ECMax	ECMin	ECl	β	ECabs	ECE
(continued)	DDAMA	CURRD	DAMAM	DFUNC	SED	PWD	Eadp		
Rubber Stretches									
TMB Stress									
TMB Strain									
TMB Plastic Strain									
TMB Creep Strain									

**2D Continuum (Plane Strain) TPN3/6, QPN4/8, TNK6,
QNK8, QPN4M**

Entity	Component												
Displacement	DX	DY	RSLT										
Stress	SX	SY	SXY	SZ	S1	S2	S3	SI	Sabs	SE			
(continued)	Damage	LogLife	DDAMA	CURRD	DAMAM	DFUNC	SED	PWD	Eadp				
Strain	EX	EY	EXY	EZ	E1	E2	E3	EI	Eabs	EE			
(continued)	DDAMA	CURRD	DAMAM	DFUNC	SED	PWD	Eadp						
Loading	FX	FY	RSLT										
Reaction	FX	FY	RSLT										
Residual Force	FX	FY	RSLT										
Reaction Stress	PX	PY											
Velocity	VX	VY	RSLT										
Acceleration	AX	AY	RSLT										
Plastic Strain	EPX	EPY	EPXY	EPZ	EP1	EP2	EP3	EPI	EPabs	EPE	CWMax	EFSMax	
(continued)	DDAMA	CURRD	DAMAM	DFUNC	SED	PWD	Eadp						
Creep Strain	ECX	ECY	ECXY	ECZ	EC1	EP2	EC3	ECI	ECabs	ECE			
(continued)	DDAMA	CURRD	DAMAM	DFUNC	SED	PWD	Eadp						
Rubber Stretches	StchX	StchY	StchXY	StchZ	Stch1	Stch2	Stch3	StchI	StchAbs	StchE			
(continued)	DDAMA	CURRD	DAMAM	DFUNC	SED	PWD	Eadp						
TMB Stress													
TMB Strain													
TMB Plastic Strain													
TMB Creep Strain													

Notes:

Rubber stretches are only available for QPN4M elements with rubber material models. Strains are not available for this element when using rubber materials.

Plastic strain components CWMax and EFSMax are only available when the Smoothed Multi-crack Concrete Models (105 and 109) are used.

2D Continuum (Plane Strain) [QPN4L](#)

Entity	Component									
Displacement	DX	DY	RSLT							
Stress	SX	SY	SXY	SZ	S1	S2	S3	SI	SE	
Strain	StchX	StchY	StchXY	StchZ	Stch1	Stch2	Stch3	StchI	StchE	
Loading	FX	FY	RSLT							
Reaction	FX	FY	RSLT							
Residual Force	FX	FY	RSLT							
Reaction Stress	PX	PY								
Velocity	VX	VY	RSLT							
Acceleration	AX	AY	RSLT							
Plastic Strain	EPX	EPY	EPXY	EPZ	EP1	EP2	EP3	EPI	EPE	
Creep Strain										
Rubber Stretches	StchX	StchY	StchXY	StchZ	Stch1	Stch2	Stch3	StchI	StchE	
TMB Stress										
TMB Strain										
TMB Plastic Strain										
TMB Creep Strain										

2D Plane Strain Two Phase Continuum TPN6P, QPN8P

Entity	Component											
Displacement	DX	DY	RSLT	Pres								
Stress	SX	SY	SXY	SZ	Pres	S1	S2	S3	SI	Sabs	SE	
(continued)	Damage	LogLife	DDAMA	CURRD	DAMAM	DFUNC	SED	PWD	Eadp			
Strain	EX	EY	EXY	EZ	EV	E1	E2	E3	EI	Eabs	EE	
(continued)	DDAMA	CURRD	DAMAM	DFUNC	SED	PWD	Eadp					
Loading	FX	FY	RSLT	Q								
Reaction	FX	FY	RSLT	Q								
Residual Force	FX	FY	RSLT									
Reaction Stress	PX	PY										
Velocity	VX	VY	RSLT									
Acceleration	AX	AY	RSLT									
Plastic Strain	EPX	EPY	EPXY	EPZ	EP1	EP2	EP3	EPI	EPabs	EPE	CWMax	EFSMax
(continued)	DDAMA	CURRD	DAMAM	DFUNC	SED	PWD	Eadp					
Creep Strain	ECX	ECY	ECXY	ECZ	EC1	EP2	EC3	ECI	ECabs	ECE		
(continued)	DDAMA	CURRD	DAMAM	DFUNC	SED	PWD	Eadp					
Rubber Stretches												
TMB Stress												
TMB Strain												
TMB Plastic Strain												
TMB Creep Strain												

Notes

Plastic strain components CWMax and EFSMax are only available when the Smoothed Multi-crack Concrete Model (Model 109) is used.

2D Continuum Plane Strain (Explicit Dynamics) [TPN3E](#), [QPN4E](#)

Entity	Component										
Displacement	DX	DY	RSLT								
Stress	SX	SY	SXY	SZ	S1	S2	S3	SI	Sabs	SE	
(continued)	Damage	LogLife	DDAMA	CURRD	DAMAM	DFUNC	SED	PWD	Eadp		
Strain	EX	EY	EXY	EZ	E1	E2	E3	EI	Eabs	EE	
(continued)	DDAMA	CURRD	DAMAM	DFUNC	SED	PWD	Eadp				
Loading	FX	FY	RSLT								
Reaction	FX	FY	RSLT								
Residual Force	FX	FY	RSLT								
Reaction Stress	PX	PY									
Velocity	VX	VY	RSLT								
Acceleration	AX	AY	RSLT								
Plastic Strain	EPX	EPY	EPXY	EPZ	EP1	EP2	EP3	EPI	EPabs	EPE	
(continued)	DDAMA	CURRD	DAMAM	DFUNC	SED	PWD	Eadp				
Creep Strain	ECX	ECY	ECXY	ECZ	EC1	EP2	EC3	ECI	ECabs	ECE	
(continued)	DDAMA	CURRD	DAMAM	DFUNC	SED	PWD	Eadp				
Rubber Stretches											
TMB Stress											
TMB Strain											
TMB Plastic Strain											
TMB Creep Strain											

2D Continuum Axisymmetric Solid (Explicit Dynamics)

TAX3E, QAX4E

Entity	Component										
Displacement	DX	DY	RSLT	Pres							
Stress	SX	SY	SXY	SZ	S1	S2	S3	SI	Sabs	SE	
(continued)	Damage	LogLife	DDAMA	CURRD	DAMAM	DFUNC	SED	PWD	Eadp		
Strain	EX	EY	EXY	EZ	E1	E2	E3	EI	Eabs	EE	
(continued)	DDAMA	CURRD	DAMAM	DFUNC	SED	PWD	Eadp				
Loading	FX	FY	RSLT								
Reaction	FX	FY	RSLT								
Residual Force	FX	FY	RSLT								
Reaction Stress	PX	PY									
Velocity	VX	VY	RSLT								
Acceleration	AX	AY	RSLT								
Plastic Strain	EPX	EPY	EPXY	EPZ	EP1	EP2	EP3	EPI	EPabs	EPE	
(continued)	DDAMA	CURRD	DAMAM	DFUNC	SED	PWD	Eadp				
Creep Strain	ECX	ECY	ECXY	ECZ	EC1	EP2	EC3	ECl	ECabs	ECE	
(continued)	DDAMA	CURRD	DAMAM	DFUNC	SED	PWD	Eadp				
Rubber Stretches											
TMB Stress											
TMB Strain											
TMB Plastic Strain											
TMB Creep Strain											

2D Axisymmetric Solid Two Phase Continuum **TAX6P**, **QAX8P**

Entity	Component											
Displacement	DX	DY	RSLT	Pres								
Stress	SX	SY	SXY	SZ	Pres	S1	S2	S3	SI	Sabs	SE	
(continued)	Damage	LogLife	DDAMA	CURRD	DAMAM	DFUNC	SED	PWD	Eadp			
Strain	EX	EY	EXY	EZ	EV	E1	E2	E3	EI	Eabs	EE	
(continued)	DDAMA	CURRD	DAMAM	DFUNC	SED	PWD	Eadp					
Loading	FX	FY	RSLT	Q								
Reaction	FX	FY	RSLT	Q								
Residual Force	FX	FY	RSLT									
Reaction Stress	PX	PY										
Velocity	VX	VY	RSLT									
Acceleration	AX	AY	RSLT									
Plastic Strain	EPX	EPY	EPXY	EPZ	EP1	EP2	EP3	EPI	EPabs	EPE	CWMax	EFSMax
(continued)	DDAMA	CURRD	DAMAM	DFUNC	SED	PWD	Eadp					
Creep Strain	ECX	ECY	ECXY	ECZ	EC1	EP2	EC3	ECI	ECabs	ECE		
(continued)	DDAMA	CURRD	DAMAM	DFUNC	SED	PWD	Eadp					
Rubber Stretches												
TMB Stress												
TMB Strain												
TMB Plastic Strain												
TMB Creep Strain												

Notes

Plastic strain components CWMax and EFSMax are only available when the Smoothed Multi-crack Concrete Model (Model 109) is used.

**2D Continuum Axisymmetric Solid Fourier TAX3/6F,
QAX4/8F**

Entity		Component									
Displacement	DX	DY	DZ	RSLT							
Stress	SX	SY	SXY	SZ	S1	S2	S3	SI	Sabs	SE	
(continued)	Damage	LogLife	DDAMA	CURRD	DAMAM	DFUNC	SED	Eadp			
Strain	EX	EY	EXY	EZ	E1	E2	E3	EI	Eabs	EE	
(continued)	DDAMA	CURRD	DAMAM	DFUNC	SED	Eadp					
Loading	FX	FY	FZ	RSLT							
Reaction	FX	FY	FZ	RSLT							
Residual Force											
Reaction Stress	PX	PY									
Velocity	VX	VY	VZ	RSLT							
Acceleration	AX	AY	AZ	RSLT							
Plastic Strain											
Creep Strain											
Rubber Stretches											
TMB Stress											
TMB Strain											
TMB Plastic Strain											
TMB Creep Strain											

Axisymmetric Solid TAX3/6, QAX4/8, QAX4M, TXK6, QXK8

Entity	Component											
Displacement	DX	DY	RSLT									
Stress	SX	SY	SXY	SZ	S1	S2	S3	SI	Sabs	SE		
(continued)	Damage	LogLife	DDAMA	CURRD	DAMAM	DFUNC	SED	PWD	Eadp			
Strain	EX	EY	EXY	EZ	E1	E2	E3	EI	Eabs	EE		
(continued)	DDAMA	CURRD	DAMAM	DFUNC	SED	PWD	Eadp					
Loading	FX	FY	RSLT									
Reaction	FX	FY	RSLT									
Residual Force	FX	FY	RSLT									
Reaction Stress	PX	PY										
Velocity	VX	VY	RSLT									
Acceleration	AX	AY	RSLT									
Plastic Strain	EPX	EPY	EPXY	EPZ	EP1	EP2	EP3	EPI	EPabs	EPE	CWMax	EFSMax
(continued)	DDAMA	CURRD	DAMAM	DFUNC	SED	PWD	Eadp					
Creep Strain	ECX	ECY	ECXY	ECZ	EC1	EP2	EC3	ECI	ECabs	ECE		
(continued)	DDAMA	CURRD	DAMAM	DFUNC	SED	PWD	Eadp					
Rubber Stretches	StchX	StchY	StchXY	StchZ	Stch1	Stch2	Stch3	Stchl	StchAbs	StchE		
(continued)	DDAMA	CURRD	DAMAM	DFUNC	SED	PWD	Eadp					
TMB Stress												
TMB Strain												
TMB Plastic Strain												
TMB Creep Strain												

Notes

*Rubber stretches are only available for QAX4M elements with rubber material models.
Strains are not available for this element when using rubber materials
Plastic strain components CWMax and EFSMax are only available when the Smoothed
Multi-crack Concrete Models (105 and 109) are used.*

Axisymmetric Solid Large Strain **QAX4L**

Entity		Component									
Displacement	DX	DY	RSLT	Pres							
Stress	SX	SY	SXY	SZ	S1	S2	S3	SI	Sabs	SE	
(continued)	Damage	LogLife	DDAMA	CURRD	DAMAM	DFUNC	SED	PWD	Eadp		
Strain	StchX	StchY	StchXY	StchZ	Stch1	Stch2	Stch3	StchI	StchE		
(continued)	DDAMA	CURRD	DAMAM	DFUNC	SED	PWD	Eadp				
Loading	FX	FY	RSLT								
Reaction	FX	FY	RSLT								
Residual Force	FX	FY	RSLT								
Reaction Stress	PX	PY									
Velocity	VX	VY	RSLT								
Acceleration	AX	AY	RSLT								
Plastic Strain	EPX	EPY	EPXY	EPZ	EP1	EP2	EP3	EPI	EPE		
Creep Strain											
Rubber Stretches	StchX	StchY	StchXY	StchZ	Stch1	Stch2	Stch3	StchI	StchE		
TMB Stress											
TMB Strain											
TMB Plastic Strain											
TMB Creep Strain											

**3D Solid Continuum TH4/10, TH10S, PN6/12/15,
PN6L/12L, HX8/16/20, HX8M, HX8L/16L,
TH10K, PN15K, HX20K**

Entity	Component												
Displacement	DX	DY	DZ	RSLT									
Stress	SX	SY	SZ	SXY	SYZ	SZX	S1	S2	S3	SI	Sabs	SE	
(continued)	Damage	LogLife	DDAMA	CURRD	DAMAM	DFUNC	SED	PWD	Eadp				
Strain	EX	EY	EZ	EXY	EYZ	EZX	E1	E2	E3	EI	Eabs	EE	
(continued)	DDAMA	CURRD	DAMAM	DFUNC	SED	PWD	Eadp						
Loading	FX	FY	FZ	RSLT									
Reaction	FX	FY	FZ	RSLT									
Residual Force	FX	FY	FZ	RSLT									
Reaction Stress	PX	PY	PZ										
Velocity	VX	VY	VZ	RSLT									
Acceleration	AX	AY	AZ	RSLT									
Plastic Strain	EPX	EPY	EPZ	EPXY	EPYZ	EPZX	EP1	EP2	EP3	EPI	EPabs	EPE	
(continued)	DDAMA	CURRD	DAMAM	DFUNC	SED	PWD	Eadp	CWMax	EFSMax				
Creep Strain	ECX	ECY	ECZ	ECXY	ECYZ	ECZX	EC1	EC2	EC3	ECI	ECabs	ECE	
(continued)	DDAMA	CURRD	DAMAM	DFUNC	SED	PWD	Eadp						
Rubber Stretches	StchX	StchY	StchZ	StchXY	StchYZ	StchZX	Stch1	Stch2	Stch3	Stchl	StchAbs	StchE	
(continued)	DDAMA	CURRD	DAMAM	DFUNC	SED	PWD	Eadp						
TMB Stress													
TMB Strain													
TMB Plastic Strain													
TMB Creep Strain													

Notes:

*Rubber stretches are only available for HX8M elements with rubber material models.
Strains are not available for this element when using rubber materials.
Plastic strain components CWMax and EFSMax are only available when the Smoothed Multi-crack Concrete Models (105 and 109) are used.*

3D Solid Continuum Two Phase TH10P, PN12P, PN15P, HX16P, HX20P

Entity	Component												
Displacement	DX	DY	DZ	RSLT	Pres								
Stress	SX	SY	SZ	SXY	SYZ	SZX	Pres	S1	S2	S3	SI	Sabs	SE
(continued)	Damage	LogLife	DDAMA	CURRD	DAMAM	DFUNC	SED	PWD	Eadp				
Strain	EX	EY	EZ	EXY	EYZ	EZX	EV	E1	E2	E3	EI	Eabs	EE
(continued)	DDAMA	CURRD	DAMAM	DFUNC	SED	PWD	Eadp						
Loading	FX	FY	FZ	RSLT	Q								
Reaction	FX	FY	FZ	RSLT	Q								
Residual Force	FX	FY	FZ	RSLT									
Reaction Stress	PX	PY	PZ										
Velocity	VX	VY	VZ	RSLT									
Acceleration	AX	AY	AZ	RSLT									
Plastic Strain	EPX	EPY	EPZ	EPXY	EPYZ	EPZX	EP1	EP2	EP3	EPI	EPabs	EPE	
(continued)	DDAMA	CURRD	DAMAM	DFUNC	SED	PWD	Eadp	CWMax	EFSMax				
Creep Strain	ECX	ECY	ECZ	ECXY	ECYZ	ECZX	EC1	EC2	EC3	ECI	ECabs	ECE	
(continued)	DDAMA	CURRD	DAMAM	DFUNC	SED	PWD	Eadp						
Rubber Stretches													
TMB Stress													
TMB Strain													
TMB Plastic Strain													
TMB Creep Strain													

Notes

Plastic strain components CWMax and EFSMax are only available when the Smoothed Multi-crack Concrete Model (Model 109) is used.

3D Solid Continuum Explicit Dynamics [TH4E](#), [PN6E](#), [HX8E](#)

Entity		Component										
Displacement	DX	DY	DZ	RSLT	Pres							
Stress	SX	SY	SZ	SXY	SYZ	SZX	S1	S2	S3	SI	Sabs	SE
(continued)	Damage	LogLife	DDAMA	CURRD	DAMAM	DFUNC	SED	PWD	Eadp			
Strain												
Loading	FX	FY	FZ	RSLT								
Reaction	FX	FY	FZ	RSLT								
Residual Force	FX	FY	FZ	RSLT								
Reaction Stress	PX	PY	PZ									
Velocity	VX	VY	VZ	RSLT								
Acceleration	AX	AY	AZ	RSLT								
Plastic Strain												
Creep Strain												
Rubber Stretches												
TMB Stress												
TMB Strain												
TMB Plastic Strain												
TMB Creep Strain												

Isoflex Thin Plates **TF3**, **QF4**

Entity		Component													
Displacement	DZ	RSLT	THX	THY											
Stress	MX	MY	MX _Y	MMax	MMin	MI	β	Nabs	ME	Mx(T)	My(T)	Mx(B)	My(B)	Util(T)	Util(B)
(continued)	Damage	LogLife	SED	PWD	Eadp										
Strain	BX	BY	BXY	BMax	BMin	BI	β	Eabs	BE	SED	PWD	Eadp			
Loading	FZ	RSLT	MX	MY											
Reaction	FZ	RSLT	MX	MY											
Residual Force	FZ	RSLT	MX	MY											
Reaction Stress	PZ														
Velocity	VZ	RSLT													
Acceleration	AZ	RSLT													
Plastic Strain															
Creep Strain															
Rubber Stretches															
TMB Stress	SX	SY	SXY	SMax	SMin	SI	β	Sabs	SE	Damage	LogLife	SED	PWD	Eadp	
TMB Strain	EX	EY	EXY	EMax	EMin	EI	β	Eabs	EE	SED	PWD	Eadp			
TMB Plastic Strain															
TMB Creep Strain															

Isoflex Thick Plates **QSC4**

Entity	Component														
Displacement	DZ	RSLT	THX	THY											
Stress	MX	MY	MXY	Sx	Sy	MMax	MMin	MI	β	Nabs	ME	Mx(T)	My(T)	Mx(B)	My(B)
(continued)	Util(T)	Util(B)	Damage	LogLife	SED	PWD	Eadp								
Strain	BX	BY	BCY	EZX	EYZ	BMax	BMin	BI	β	Eabs	BE	SED	PWD	Eadp	
Loading	FZ	RSLT	MX	MY											
Reaction	FZ	RSLT	MX	MY											
Residual Force	FZ	RSLT	MX	MY											
Reaction Stress	PZ														
Velocity	VZ	RSLT													
Acceleration	AZ	RSLT													
Plastic Strain															
Creep Strain															
Rubber Stretches															
TMB Stress	SX	SY	SXY	SMax	SMin	SI	β	Sabs	SE	Damage	LogLife	SED	PWD	Eadp	
TMB Strain	EX	EY	EXY	EMax	EMin	EI	β	Eabs	EE	SED	PWD	Eadp			
TMB Plastic Strain															
TMB Creep Strain															

Mindlin Thick Plates TTF6, QTF8

Entity	Component														
Displacement	DZ	RSLT	THX	THY											
Stress	MX	MY	MXY	Sx	Sy	MMax	MMin	MI	β	Nabs	ME	Mx(T)	My(T)	Mx(B)	My(B)
(continued)	Util(T)	Util(B)	Damage	LogLife	SED	PWD	Eadp								
Strain	BX	BY	BXY	EZX	EYZ	BMax	BMin	BI	β	Eabs	BE	SED	PWD	Eadp	
Loading	FZ	RSLT	MX	MY											
Reaction	FZ	RSLT	MX	MY											
Residual Force	FZ	RSLT	MX	MY											
Reaction Stress	PZ														
Velocity	VZ	RSLT													
Acceleration	AZ	RSLT													
Plastic Strain															
Creep Strain															
Rubber Stretches															
TMB Stress	SX	SY	SXY	SMax	SMin	SI	β	Sabs	SE	Damage	LogLife	SED	PWD	Eadp	
TMB Strain	EX	EY	EXY	EMax	EMin	EI	β	Eabs	EE	SED	PWD	Eadp			
TMB Plastic Strain															
TMB Creep Strain															

2D Axisymmetric Membranes **BXM2**, **BXM3**

Entity		Component								
Displacement	DX	DY	RSLT							
Stress	Sx	Sz	SMax	SMin	SI	β	Sabs	SE		
(continued)	Damage	LogLife	DDAMA	CURRD	DAMAM	DFUNC	SED	PWD	Eadp	
Strain	Ex	Ez	EMax	EMin	EI	β	Eabs	EE		
(continued)	DDAMA	CURRD	DAMAM	DFUNC	SED	PWD	Eadp			
Loading	FX	FY	RSLT							
Reaction	FX	FY	RSLT							
Residual Force	FX	FY	RSLT							
Reaction Stress	PX	PY								
Velocity	VX	VY	RSLT							
Acceleration	AX	AY	RSLT							
Plastic Strain	EPx	EPz	EPMax	EPMin	EPI	β	EPabs	EPE		
(continued)	DDAMA	CURRD	DAMAM	DFUNC	SED	PWD	Eadp			
Creep Strain	ECx	ECz	ECMax	ECMin	ECl	β	ECabs	ECE		
(continued)	DDAMA	CURRD	DAMAM	DFUNC	SED	PWD	Eadp			
Rubber Stretches										
TMB Stress										
TMB Strain										
TMB Plastic Strain										
TMB Creep Strain										

Note: Rubber models are available for use with the BXM2 element, however strains are output and rubber stretches are not available.

3D Space Membranes TSM3, SMI4

Entity	Component									
Displacement	DX	DY	DZ	RSLT						
Stress	Nx	Ny	Nxy	NMax	NMin	Ns	β	Nabs	Ne	
(continued)	Damage	LogLife	DDAMA	CURRD	DAMAM	DFUNC	SED	PWD	Eadp	
Strain	Ex	Ey	Exy	EMax	EMin	EI	β	Eabs	EE	
(continued)	DDAMA	CURRD	DAMAM	DFUNC	SED	PWD	Eadp			
Loading	FX	FY	FZ	RSLT						
Reaction	FX	FY	FZ	RSLT						
Residual Force	FX	FY	FZ	RSLT						
Reaction Stress	PX	PY	PZ							
Velocity	VX	VY	VZ	RSLT						
Acceleration	AX	AY	AZ	RSLT						
Plastic Strain										
Creep Strain										
Rubber Stretches										
TMB Stress	SX	SY	SZ	SXY	SYZ	SZX	S1	S2	S3	SI Sabs SE
(continued)	DDAMA	CURRD	DAMAM	DFUNC	SED	PWD	Eadp			
TMB Strain	EX	EY	EZ	EXY	EYZ	EZX	E1	E2	E3	EI Eabs EE
(continued)	DDAMA	CURRD	DAMAM	DFUNC	SED	PWD	Eadp			
TMB Plastic Strain										
TMB Creep Strain										

2D Thin Axisymmetric Shells **BXS3**

Entity	Component									
Displacement	DX	DY	RSLT	THZ	DU					
Stress	Nx	Nz	Mx	Mz	Ny	NMax	NMin	Ns	β	Nabs Ne
(continued)	Damage	LogLife	DDAMA	CURRD	DAMAM	DFUNC	SED	PWD	Eadp	
Strain	Ex	Ez	Bx	Bz	Ey	EMax	EMin	EI	β	Eabs EE
(continued)	DDAMA	CURRD	DAMAM	DFUNC	SED	PWD	Eadp			
Loading	FX	FY	RSLT	MZ	FDU					
Reaction	FX	FY	RSLT	MZ	FDU					
Residual Force	FX	FY	RSLT	MZ	FDU					
Reaction Stress	PX	PY								
Velocity	VX	VY	RSLT							
Acceleration	AX	AY								
Plastic Strain										
Creep Strain										
Rubber Stretches										
TMB Stress	Sx	Sz	SMax	SMin	SI	β	Sabs	SE		
(continued)	Damage	LogLife	DDAMA	CURRD	DAMAM	DFUNC	SED	PWD	Eadp	
TMB Strain	Ex	Ez	EPMax	EMin	EI	β	Eabs	EE		
(continued)	DDAMA	CURRD	DAMAM	DFUNC	SED	PWD	Eadp			
TMB Plastic Strain	EPx	EPz	EPMax	EPMIn	EPI	β	EPabs	EPE		
(continued)	DDAMA	CURRD	DAMAM	DFUNC	SED	PWD	Eadp			
TMB Creep Strain	ECx	ECz	ECMax	ECMin	ECI	β	ECabs	ECE		
(continued)	DDAMA	CURRD	DAMAM	DFUNC	SED	PWD	Eadp			

2D Thick Axisymmetric Shells **BXSI2**, **BXSI3**

Entity		Component									
Displacement		DX	DY	RSLT	THZ						
Stress		Nx	Nz	Mx	Mz	Nxy	NMax	NMin	Ns	β	Nabs Ne
(continued)	Damage	LogLife	DDAMA	CURRD	DAMAM	DFUNC	SED	PWD	Eadp		
Strain		Ex	Ez	Bx	Bz	Exy	EMax	EMin	EI	β	Eabs EE
(continued)	DDAMA	CURRD	DAMAM	DFUNC	SED	PWD	Eadp				
Loading		FX	FY	RSLT	MZ						
Reaction		FX	FY	RSLT	MZ						
Residual Force		FX	FY	RSLT	MZ						
Reaction Stress		PX	PY								
Velocity		VX	VY	RSLT							
Acceleration		AX	AY								
Plastic Strain											
Creep Strain											
Rubber Stretches											
TMB Stress		Sx	Sz	Sxy	SMax	SMin	SI	β	Sabs	SE	
(continued)	Damage	LogLife	DDAMA	CURRD	DAMAM	DFUNC	SED	PWD	Eadp		
TMB Strain		Ex	Ez	Exy	EPMax	EMin	EI	β	Eabs	EE	
(continued)	DDAMA	CURRD	DAMAM	DFUNC	SED	PWD	Eadp				
TMB Plastic Strain		EPx	EPz	EPxy	EPMax	EPMin	EPI	β	EPabs	EPE	
(continued)	DDAMA	CURRD	DAMAM	DFUNC	SED	PWD	Eadp				
TMB Creep Strain		ECx	ECz	ECxy	ECMax	ECMin	ECl	β	ECabs	ECE	
(continued)	DDAMA	CURRD	DAMAM	DFUNC	SED	PWD	Eadp				

3D Flat Thin Shells **TS3**, **QSI4**

Entity		Component													
Displacement	DX	DY	DZ	RSLT	THX	THY	THZ								
Stress	Nx	Ny	Nxy	Mx	My	Mxy	NMax	NMin	Ns	β	Nabs	Ne	Nx(T)/ Mx(T)	Ny(T)/ Ny(T)	Nx(B)/ Mx(B)
(continued)	Ny(B)/ My(B)	Util(T)	Util(B)	MUtil(T)	MUtil(B)	Damage	LogLife	DDAMA	CURRD	DAMAM	DFUNC	SED	Fc(T)	Fc(B)	Eadp
Strain	Ex	Ey	Exy	Bx	By	Bxy	EMax	EMin	EI	β	Eabs	EE			
(continued)	DDAMA	CURRD	DAMAM	DFUNC	SED	Eadp									
Loading	FX	FY	FZ	RSLT	MX	MY	MZ								
Reaction	FX	FY	FZ	RSLT	MX	MY	MZ								
Residual Force	FX	FY	FZ	RSLT	MX	MY	MZ								
Reaction Stress	PX	PY	PZ												
Velocity	VX	VY	VZ	RSLT											
Acceleration	AX	AY	AZ	RSLT											
Plastic Strain															
Creep Strain															
Rubber Stretches															
TMB Stress	SX	SY	SZ	SXY	SYZ	SZX	S1	S2	S3	SI	Sabs	SE			
(continued)	Damage	LogLife	DDAMA	CURRD	DAMAM	DFUNC	SED	Eadp							
TMB Strain	EX	EY	EZ	EXY	EYZ	EZX	E1	E2	E3	EI	Eabs	EE			
(continued)	DDAMA	CURRD	DAMAM	DFUNC	SED	PWD	Eadp								
TMB Plastic Strain															
TMB Creep Strain															

3D Flat Thin Nonlinear Shell **TSR6**

Entity	Component														
Displacement	DX	DY	DZ	RSLT	THL1										
Stress	Nx	Ny	Nxy	Mx	My	Mxy	NMax	NMin	Ns	β	Nabs	Ne	Nx(T)/ Mx(T)	Ny(T)/ Ny(T)	Nx(B)/ Mx(B)
(continued)	Ny(B)/ My(B)	Util(T)	Util(B)	MUtil(T)	MUtil(B)	Damage	LogLife	DDAMA	CURRD	DAMAM	DFUNC	SED	PWD	Fc(T)	Fc(B)
Eadp															
Strain	Ex	Ey	Exy	Bx	By	Bxy	EMax	EMin	EI	β	Eabs	EE			
(continued)	DDAMA	CURRD	DAMAM	DFUNC	SED	PWD	Eadp								
Loading	FX	FY	FZ	RSLT	ML1										
Reaction	FX	FY	FZ	RSLT	ML1										
Residual Force	FX	FY	FZ	RSLT	ML1										
Reaction Stress	PX	PY	PZ												
Velocity	VX	VY	VZ	RSLT											
Acceleration	AX	AY	AZ	RSLT											
Plastic Strain															
Creep Strain															
Rubber Stretches															
TMB Stress	SX	SY	SZ	SXY	SYZ	SZX	S1	S2	S3	SI	Sabs	SE			
(continued)	Damage	LogLife	DDAMA	CURRD	DAMAM	DFUNC	SED	Eadp							
TMB Strain	EX	EY	EZ	EXY	EYZ	EZX	E1	E2	E3	EI	Eabs	EE			
(continued)	DDAMA	CURRD	DAMAM	DFUNC	SED	PWD	Eadp								
TMB Plastic Strain	EPX	EPY	EPZ	EPXY	EPYZ	EPZX	EP1	EP2	EP3	EPI	EPabs	EPE	CWMax	EFSMax	
(continued)	DDAMA	CURRD	DAMAM	DFUNC	SED	PWD	Eadp								
TMB Creep Strain	ECX	ECY	ECZ	ECXY	ECYZ	ECZX	EC1	EC2	EC3	ECI	ECabs	ECE			
(continued)	DDAMA	CURRD	DAMAM	DFUNC	SED	PWD	Eadp								

Notes

TMB Plastic strain components CWMax and EFSMax are only available when the Smoothed Multi-crack Concrete Model (Model 109) is used.

Semiloof Shells **TSL6**, **QSL8**

Entity		Component													
Displacement	DX	DY	DZ	RSLT	THL1	THL2									
Stress	Nx	Ny	Nxy	Mx	My	Mxy	NMax	NMin	Ns	β	Nabs	Ne	Nx(T)/ Mx(T)	Ny(T)/ My(T)	Nx(B)/ Mx(B)
(continued)	Ny(B)/ My(B)	Util(T)	Util(B)	MUtil(T)	MUtil(B)	Damage	LogLife	DDAMA	CURRD	DAMAM	DFUNC	SED	PWD	Fc(T)	Fc(B)
(continued)	Eadp														
Strain	Ex	Ey	Exy	Bx	By	Bxy	EMax	EMin	EI	β	Eabs	EE			
(continued)	DDAMA	CURRD	DAMAM	DFUNC	SED	PWD	Eadp								
Loading	FX	FY	FZ	RSLT	ML1	ML2									
Reaction	FX	FY	FZ	RSLT	ML1	ML2									
Residual Force	FX	FY	FZ	RSLT	ML1	ML2									
Reaction Stress	PX	PY	PZ												
Velocity	VX	VY	VZ	RSLT											
Acceleration	AX	AY	AZ	RSLT											
Plastic Strain															
Creep Strain															
Rubber Stretches															
TMB Stress	SX	SY	SZ	SXY	SYZ	SZX	S1	S2	S3	SI	Sabs	SE			
(continued)	Damage	LogLife	DDAMA	CURRD	DAMAM	DFUNC	SED	PWD	Eadp						
TMB Strain	EX	EY	EZ	EXY	EYZ	EZX	E1	E2	E3	EI	Eabs	EE			
(continued)	DDAMA	CURRD	DAMAM	DFUNC	SED	PWD	Eadp								
TMB Plastic Strain	EPX	EPY	EPZ	EPXY	EPYZ	EPZX	EP1	EP2	EP3	EPI	EPabs	EPE	CWMax	EFSMax	
(continued)	DDAMA	CURRD	DAMAM	DFUNC	SED	PWD	Eadp								
TMB Creep Strain	ECX	ECY	ECZ	ECXY	ECYZ	ECZX	EC1	EC2	EC3	ECI	ECabs	ECE			
(continued)	DDAMA	CURRD	DAMAM	DFUNC	SED	PWD	Eadp								

Notes

TMB Plastic strain components CWMax and EFSMax are only available when the Smoothed Multi-crack Concrete Model (Model 109) is used.

3D Thick Shells TTS3, TTS6, QTS4, QTS8

Entity		Component														
Displacement		DX	DY	DZ	RSLT	THX	THY	THZ								
Stress		Nx	Ny	Nxy	Mx	My	Mxy	Sx	Sy	NMax	NMin	β	Nabs	NE	Nx(T)/ Mx(T)	Ny(T)/ My(T)
(continued)		Nx(B)/M x(B)	Ny(B)/ My(B)	Util(T)	Util(B)	MUtil(T)	MUtil(B)	Damage	LogLife	DDAMA	CURRD	DAMAM	DFUNC	SED	PWD	Fc(T)
(continued)		Fc(B)	Eadp													
Strain																
Loading		FX	FY	FZ	RSLT	MX	MY	MZ								
Reaction		FX	FY	FZ	RSLT	MX	MY	MZ								
Residual Force		FX	FY	FZ	RSLT	MX	MY	MZ								
Reaction Stress		PX	PY	PZ												
Velocity		VX	VY	VZ	RSLT											
Acceleration		AX	AY	AZ	RSLT											
Plastic Strain																
Creep Strain																
Rubber Stretches																
TMB Stress		SX	SY	SZ	SXY	SYZ	SZX	S1	S2	S3	SI	Nabs	SE			
(continued)		Damage	LogLife	DDAMA	CURRD	DAMAM	DFUNC	SED	PWD	Eadp						
TMB Strain		EX	EY	EZ	EXY	EYZ	EZX	E1	E2	E3	EI	Eabs	EE			
(continued)		DDAMA	CURRD	DAMAM	DFUNC	SED	PWD	Eadp								
TMB Plastic Strain		EPX	EPY	EPZ	EPXY	EPYZ	EPZX	EP1	EP2	EP3	EPI	EPabs	EPE	CWMax	EFSMax	
(continued)		DDAMA	CURRD	DAMAM	DFUNC	SED	PWD	Eadp								
TMB Creep Strain		ECX	ECY	ECZ	ECXY	ECYZ	ECZX	EC1	EC2	EC3	ECI	ECabs	ECE			
(continued)		DDAMA	CURRD	DAMAM	DFUNC	SED	PWD	Eadp								

Notes

TMB Plastic strain components CWMax and EFSMax are only available when the Smoothed Multi-crack Concrete Model (Model 109) is used.

2D Joints (for Bars, Plane Stress and Plane Strain)

JNT3

Entity		Component					
Displacement	DX DY	RSLT					
Stress	Fx Fy	Damage	LogLife	SED	PWD	Eadp	
Strain	Ex Ey	SED	PWD	Eadp			
Loading	FX FY	RSLT					
Reaction	FX FY	RSLT					
Residual Force	FX FY	RSLT					
Reaction Stress							
Velocity	VX VY	RSLT					
Acceleration	AX AY	RSLT					
Plastic Strain	EPx EPy	SED	PWD	Eadp			
Creep Strain							
Rubber Stretches							
TMB Stress							
TMB Strain							
TMB Plastic Strain							
TMB Creep Strain							

2D Joints (for Engineering and Kirchhoff Beams) [JPH3](#)

Entity	Component								
Displacement	DX	DY	RSLT	THZ					
Stress	Fx	Fy	Mz	Damage	LogLife	SED	PWD	Eadp	
Strain	Ex	Ey	Bz	SED	PWD	Eadp			
Loading	FX	FY	RSLT	MZ					
Reaction	FX	FY	RSLT	MZ					
Residual Force	FX	FY	RSLT	MZ					
Reaction Stress									
Velocity	VX	VY	RSLT						
Acceleration	AX	AY	RSLT						
Plastic Strain	EPx	EPy	BPz	SED	PWD	Eadp			
Creep Strain									
Rubber Stretches									
TMB Stress									
TMB Strain									
TMB Plastic Strain									
TMB Creep Strain									

2D Joints (for Grillage Beams and Plates) **JF3**

Entity	Component								
Displacement	DZ	RSLT	THXZ	THY					
Stress	Fz	Mx	My	Damage	LogLife	SED	PWD	Eadp	
Strain	Ez	Bx	By	SED	PWD	Eadp			
Loading	FZ	RSLT	MX	MY					
Reaction	FZ	RSLT	MX	MY					
Residual Force	FZ	RSLT	MX	MY					
Reaction Stress									
Velocity	VZ	RSLT							
Acceleration	AZ	RSLT							
Plastic Strain	EPx	EPy	BPz	SED	PWD	Eadp			
Creep Strain									
Rubber Stretches									
TMB Stress									
TMB Strain									
TMB Plastic Strain									
TMB Creep Strain									

2D Joints (for Axisymmetric Solids) [JAX3](#)

Entity		Component						
Displacement	DX	DY	RSLT					
Stress	Fx	Fy	Damage	LogLife	SED	PWD	Eadp	
Strain	Ex	Ey	SED	PWD	Eadp			
Loading	FX	FY	RSLT	MZ				
Reaction	FX	FY	RSLT	MZ				
Residual Force	FX	FY	RSLT	MZ				
Reaction Stress								
Velocity	VX	VY	RSLT					
Acceleration	AX	AY	RSLT					
Plastic Strain	EPx	EPy	SED	PWD	Eadp			
Creep Strain								
Rubber Stretches								
TMB Stress								
TMB Strain								
TMB Plastic Strain								
TMB Creep Strain								

2D Joints (for Axisymmetric Shells) **JXS3**

Entity	Component								
Displacement	DX	DY	RSLT	THZ					
Stress	Fx	Fy	Mz	Damage	LogLife	SED	PWD	Eadp	
Strain	Ex	Ey	Bz	SED	PWD	Eadp			
Loading	FX	FY	RSLT	MZ					
Reaction	FX	FY	RSLT	MZ					
Residual Force	FX	FY	RSLT	MZ					
Reaction Stress									
Velocity	VX	VY	RSLT						
Acceleration	AX	AY	RSLT						
Plastic Strain	EPx	EPy	BPz	SED	PWD	Eadp			
Creep Strain									
Rubber Stretches									
TMB Stress									
TMB Strain									
TMB Plastic Strain									
TMB Creep Strain									

3D Joints (for general 3 dof connection) **JNT4, JL43**

(for Bars, Solids, Space Membranes and Semiloof Shell Corners)

Entity		Component						
Displacement	DX DY DZ	RSLT						
Stress	Fx Fy Fz	Damage	LogLife	SED	PWD	Eadp		
Strain	Ex Ey Ez	SED	PWD	Eadp				
Loading	FX FY FZ	RSLT						
Reaction	FX FY FZ	RSLT						
Residual Force	FX FY FZ	RSLT						
Reaction Stress								
Velocity	VX VY VZ	RSLT						
Acceleration	AX AY AZ	RSLT						
Plastic Strain	EPx EPy EPz	SED	PWD	Eadp				
Creep Strain								
Rubber Stretches								
TMB Stress								
TMB Strain								
TMB Plastic Strain								
TMB Creep Strain								

3D Joints (for general 6 dof connection) [JSH4](#), [JL46](#)

(for Engineering, Kirchhoff and Semiloof Beam End Nodes)

Entity	Component											
Displacement	DX	DY	DZ	RSLT	THX	THY	THZ					
Stress	Fx	Fy	Fz	Mx	My	Mz	Damage	LogLife	SED	PWD	Eadp	
Strain	Ex	Ey	Ez	Bx	By	Bz	SED	PWD	Eadp			
Loading	FX	FY	FZ	RSLT	MX	MY	MZ					
Reaction	FX	FY	FZ	RSLT	MX	MY	MZ					
Residual Force	FX	FY	FZ	RSLT	MX	MY	MZ					
Reaction Stress												
Velocity	VX	VY	VZ	RSLT								
Acceleration	AX	AY	AZ	RSLT								
Plastic Strain	EPx	EPy	EPz	BPx	BPy	BPz	SED	PWD	Eadp			
Creep Strain												
Rubber Stretches												
TMB Stress												
TMB Strain												
TMB Plastic Strain												
TMB Creep Strain												

3D Joints (for Semiloof Element Mid-side Nodes) [JSL4](#)

Entity		Component								
Displacement	DX	DY	DZ	RSLT	THL1	THL2				
Stress	Fx	Fy	Fz	M1	M2	Damage	LogLife	SED	PWD	Eadp
Strain	Ex	Ey	Ez	B1	B2	SED	PWD	Eadp		
Loading	FX	FY	FZ	RSLT	ML1	ML2				
Reaction	FX	FY	FZ	RSLT	ML1	ML2				
Residual Force	FX	FY	FZ	RSLT	ML1	ML2				
Reaction Stress										
Velocity	VX	VY	VZ	RSLT						
Acceleration	AX	AY	AZ	RSLT						
Plastic Strain	EPx	EPy	EPz	BP1	BP2	SED	PWD	Eadp		
Creep Strain										
Rubber Stretches										
TMB Stress										
TMB Strain										
TMB Plastic Strain										
TMB Creep Strain										

Thermal Bars [BFD2/3](#), [BFS2/3](#), [BFX2/3](#)

Entity	Component
Potential	PHI
Gradient	Gx Eadp
Flux	qx Eadp
Reaction	Q

Thermal Links [LFD2](#), [LFS2](#), [LFX2](#)

Entity	Component
Potential	PHI
Gradient	n.a. Eadp
Flux	qx Eadp
Reaction	Q

Plane and Axisymmetric Field [TFD3/6](#), [QFD4/8](#), [TXF3/6](#), [QXF4/8](#)

Entity	Component
Potential	PHI
Gradient	Gx Gy Eadp
Flux	qx qy Eadp
Reaction	Q

Solid Field [TF4/10](#), [PF6/12/15](#), [HF8/16/20](#), [TF10S](#), [PF6C/12C](#), [HF8C/16C](#)

Entity	Component				
Potential	PHI				
Gradient	Gx	Gy	Gz	Eadp	
Flux	qx	qy	qz	Eadp	
Reaction	Q				

**Plane and Axisymmetric Hygro-Thermal [THT3/6](#),
[QHT4/8](#), [TXHT3/6](#), [QXHT4/8](#)**

Entity	Component								
Nodal variable	T								
Temperature flux	qX	qY	qZ	RSLT					
Water vapour flux	JVX	JyY	JVZ	RSLT					
Liquid water flux	JWX	JWY	JWZ	RSLT					
Temperature gradient	GTX	GTY	GTZ	RSLT					
Water saturation gradient	GWX	GWY	GWZ	RSLT					
Other hygro-thermal results	SW	ROWC	PV	DH	TEFH	POR	TC	PMD	Hr

Hygro-thermal results components:

SW = Water saturation

ROWC = Liquid water content

PV = Water vapour pressure

DH = Degree of hydration

TEFH = Effective time of hydration

POR = Porosity

TC = Thermal conductivity

PMD = Water permeability

Hr = Relative humidity

Solid Hygro-Thermal [THT4/10](#), [PHT6/12/16](#), [HHT8/16/20](#)

Entity	Component								
--------	-----------	--	--	--	--	--	--	--	--

Nodal variable	T								
Temperature flux	qX	qY	qZ	RSLT					
Water vapour flux	JvX	JyY	JvZ	RSLT					
Liquid water flux	JwX	JwY	JwZ	RSLT					
Temperature gradient	GTX	GTY	GTZ	RSLT					
Water saturation gradient	GWX	GWY	GWZ	RSLT					
Other hygro-thermal results	SW	ROWC	PV	DH	TEFH	POR	TC	PMD	Hr

Hygro-thermal results components:

SW = Water saturation

ROWC = Liquid water content

PV = Water vapour pressure

DH = Degree of hydration

TEFH = Effective time of hydration

POR = Porosity

TC = Thermal conductivity

PMD = Water permeability

Hr = Relative humidity

2D Interface Element IPN4, IPN6, IAX4, IAX6

Entity		Component				
Displacement	Dx Dy	RSLT				
Stress	Sx Sy	Damage	LogLife	Eadp		
Strain	Ex Ey	Eadp				
Loading	Fx Fy	RSLT	MZ			
Reaction	Fx Fy	RSLT	MZ			
Residual Force	Fx Fy	RSLT				
Reaction Stress						
Velocity	Vx Vy	RSLT				
Acceleration	Ax Ay	RSLT				
Plastic Strain						
Creep Strain						
Rubber Stretches						
TMB Stress						
TMB Strain						
TMB Plastic Strain						
TMB Creep Strain						

2D Two Phase Interface Elements **IPN6P**, **IPN8P**

Entity		Component					
Displacement	Dx Dy	RSLT	Press				
Stress	Sx Sy	Q	Damage	LogLife	Eadp		
Strain	Ex Ey	dP	Eadp				
Loading	Fx Fy	RSLT					
Reaction	Fx Fy	RSLT	Q				
Residual Force	Fx Fy	RSLT	Q				
Reaction Stress							
Velocity	Vx Vy	RSLT					
Acceleration	Ax Ay	RSLT					
Plastic Strain							
Creep Strain							
Rubber Stretches							
TMB Stress							
TMB Strain							
TMB Plastic Strain							
TMB Creep Strain							

3D Interface Element IS6 IS8 IS12 IS16

Entity		Component				
Displacement	Dx Dy	RSLT				
Stress	Sx Sy Sz	Ez	Eadp			
Strain	Ex Ey	Eadp				
Loading	Fx Fy	RSLT				
Reaction	Fx Fy	RSLT				
Residual Force	Fx Fy	RSLT				
Reaction Stress						
Velocity	Vx Vy	RSLT				
Acceleration	Ax Ay	RSLT				
Plastic Strain						
Creep Strain						
Rubber Stretches						
TMB Stress						
TMB Strain						
TMB Plastic Strain						
TMB Creep Strain						

3D Two Phase Interface Element **IS12P**, **IS16P**

Entity		Component						
Displacement	Dx Dy Dz	RSLT	Press					
Stress	Sx Sy Sz	Q	Damage	LogLife	Eadp			
Strain	Ex Ey Ez	dP	Eadp					
Loading	Fx Fy Fz	RSLT						
Reaction	Fx Fy Fz	RSLT	Q					
Residual Force	Fx Fy Fz	RSLT	Q					
Reaction Stress								
Velocity	Vx Vy Vz	RSLT						
Acceleration	Ax Ay Az	RSLT						
Plastic Strain								
Creep Strain								
Rubber Stretches								
TMB Stress								
TMB Strain								
TMB Plastic Strain								
TMB Creep Strain								

Appendix L : Joint Element Compatibility

Joint Element Compatibility and Notes

Joint elements are compatible with the following elements:

Joint Element	Compatible Finite Elements	
<u>JNT3</u>	Bars	<u>BAR2</u> , <u>BAR3</u>
	2D Plane Stress	<u>TPM3</u> , <u>TPM6</u> , <u>QPM4</u> , <u>QPM8</u> , <u>TPK6</u> , <u>QPK8</u> , <u>QPM4M</u> , <u>TPM3E</u> , <u>QPM4E</u> ,
	2D Plane Strain	<u>TPN3</u> , <u>TPN6</u> , <u>QPN4</u> , <u>QPN8</u> , <u>TNK6</u> , <u>QNK8</u> , <u>TPN6P</u> , <u>QPN8P</u> , <u>QPN4M</u> , <u>QPN4L</u>
<u>JPH3</u>	2D Beams	<u>BMI2</u> , <u>BMI21</u> , <u>BMI2N</u> , <u>BMI3N</u> , <u>BMI3</u> , <u>BMI3N</u> , <u>BMI2X</u> , <u>BMI3X</u> , <u>BM3</u> , <u>BMX3</u>
<u>JF3</u>	2D Grillage	<u>GRIL</u>
	2D Plates	<u>TF3</u> , <u>QF4</u> , <u>TF6</u> , <u>QSC4</u> , <u>TTF6</u> , <u>QTF8</u>
<u>JNT4</u>	3D Bars	<u>BRS2</u> , <u>BRS3</u> ,
	3D Solids	<u>TH4</u> , <u>TH10</u> , <u>PN6</u> , <u>PN12</u> , <u>PN15</u> , <u>HX8</u> , <u>HX16</u> , <u>HX20</u> , <u>TH10P</u> , <u>PN12P</u> , <u>PN15P</u> , <u>HX16P</u> , <u>HX20P</u> , <u>HX8M</u> , <u>PN6L</u> , <u>PN12L</u> , <u>HX8L</u> , <u>HX16L</u> , <u>TH10S</u>
	Space	<u>TSM3</u> , <u>SMI4</u>

Joint Element	Compatible Finite Elements	
	Membranes	
	3D Shell	TSR6 (corner nodes)
JL43	Semiloof Shells	TSL6 , QSL8 (corner nodes)
JSH4	3D Beams	BS3 , BS4 , BSX4 , BMI21 , BMI31 , BMI22 , BMI33 , BMX21 , BMX31 , BMX22 , BMX33 , BMI21W , BMI22W , BMI31W , BMI33W , BMX21W , BMX22W , BMX31W , BMX33W
	3D Shells	TS3 , QSI4 , TTS3 , TTS6 , QTS4 , QTS8
JL46	Semiloof Beams	BSL3 , BSL4 , BXL4 (corner nodes)
JSL4	Semiloof Beams	BSL3 , BSL4 , BXL4 (mid-side nodes)
	Semiloof Shells	QSL8 , TSL6 (mid-side nodes)
JAX3	Axisymmetric Solids	TAX3 , TAX6 , QAX4 , QAX8 , TAX6P , QAX8P , TAX3E , QAX4E , TAX6P , TXK6 , QXK8 , QAX4M , QAX4L
JXS3	Axisymmetric Shells	BXS3 , BXS12 , BXS13 ,

Notes on the use of Joints

1. The nodes of a joint element need not be coincident, but for correct response the distance between them should be as small as possible. This is particularly important with joint elements which contain rotational degrees of freedom, since the stiffness matrix is not formulated using engineering beam theory. This means that a joint moment is independent of both shear force and its length. For instance, the moment calculated with a joint length of zero will remain the same magnitude at any other joint length. These effects can be exacerbated significantly in dynamic analyses (e.g. eigenvalue extraction or Hilber dynamics). Non-coincident nodes will lead to additional forces in the solution which are not in equilibrium (usually small and swamped, but could be significant sometimes). It is not recommend to have joints “hanging off” the side of a modelled structure, having a large stiffness associated.

2. If eccentricity is defined for a joint element (JPH3/JSH4/JL46), the joint will behave in the same manner as an infinitesimally short eccentric beam.
3. Joints do not support any geometric nonlinearity. They may be used, however, in geometrically nonlinear analyses but will themselves remain geometrically linear (that is, infinitesimal strain is assumed and large deformation effects are ignored).
4. The strain for a joint element is measured as follows:
 - Strain measure = (displacement for 2nd node) - (displacement for 1st node)
 - This strain being measured in the local axis system. Therefore, if node 1 is restrained, node 2 would need to be displaced in the negative local (x/y/z) direction to generate compressive contact forces.
4. The rotation output for a joint element is measured in radians.

Index

2

2D Continuum, 196, 203, 210, 216,
221, 228, 235, 240, 246, 251, 257, 264,
270, 275, 281, 287, 293
2D Interface, 530, 534
2D Joints, 424, 428, 433, 437, 442
2D Line, 557
2D Phreatic Surface, 572
2D Plane Strain Beam, 186
2D Point, 548
2D Rigid Surface, 564
2DThick Beams, 85

3

3D Continuum, 300, 307, 314, 321,
328, 335
3D Interface, 538, 543
3D Joints, 447, 452, 457, 462
3D Line, 554
3D Phreatic Surface, 574
3D Point, 551
3D Rigid Surface, 567
3D Surface, 560

A

arch, 101, 148, 155, 163
axial force, 71
Axisymmetric Shells, 364, 371
Axisymmetric Solid, 257, 264, 270,
275
Axisymmetric Solid Continuum, 281
Axisymmetric Solid Two-Phase, 287

B

bar elements
 2D, 68
 3D, 73
BAR2, 68, 631
BAR3, 68, 631
Bars, 68, 73
BEAM, 85, 186
Beam Elements, 80, 85, 94, 109, 119,
130, 142, 149, 157, 164, 171, 179, 186
Beams, 94, 142, 149
BFD2, 468, 674
BFD3, 468, 674
BFS2, 476, 674
BFS3, 476, 674
BFX2, 472, 674
BFX3, 472, 674
BM3, 142, 637

BMI2, 94, 634
BMI21, 102, 635, 636
BMI21W, 122
BMI22, 102, 635, 636
BMI22W, 122
BMI2N, 640
BMI2X, 634
BMI3, 94, 634
BMI31, 102, 635, 636
BMI31W, 122
BMI33, 102, 635, 636
BMI33W, 122
BMI3N, 640
BMI3X, 634
BMX21, 112
BMX21W, 132
BMX22, 112, 635, 636
BMX22W, 132
BMX3, 149, 637
BMX31, 112, 635, 636
BMX31W, 132
BMX33, 112
BMX33W, 132
BRS2, 73, 632
BRS3, 73, 632
BS3, 157, 638
BS4, 157, 638
BSL3, 171, 639
BSL4, 171, 639
BSX4, 164, 638
BXL4, 179, 639
BXM2, 412, 658
BXM3, 412, 658
BXS3, 364, 371, 660
BXS12, 371, 661
BXS13, 661

C

cable structures, 73
cables, 72, 76
circular plates, 416
composite, 504, 509

D

delamination, 530

E

Element Loads, 577
Engineering Beam Elements, 593, 595
Engineering Beams, 80
Environmental Temperature Loading, 580
Excessive Aspect Ratios, 587
Excessive Element Curvature, 587
Excessive Warping, 588
Explicit Dynamics, 642, 646, 647

F

Face loading, 581
 Face Loads On 2D Continuum Elements, 581
 Face Loads On 3D Continuum Elements, 582
 For Thermal Bars, 581
Field, 468, 472, 476, 480, 483, 486, 489, 494, 499, 504, 509
Flat Thin Shells, 378, 384
Fourier Ring, 293

fracture mechanics, 245
frame, 101, 146, 154, 162, 169, 177,
185
friction contact, 534

G

GRIL, 80, 633
grillage, 80
Grillage Elements, 592
groundwater, 493

H

heat conduction, 471, 482, 488
HF16, 499, 674
HF16C, 509, 674
HF20, 499, 674
HF8, 499, 674
HF8C, 509, 674
HHT16, 524, 675
HHT20, 524, 675
HHT8, 524, 675
HX16, 300, 652
HX16L, 328, 652
HX16P, 341, 653
HX20, 300, 652
HX20K, 314
HX20P, 341, 653
HX8, 300, 652
HX8E, 654
HX8L, 328, 652
HX8M, 307, 652
Hygro-thermal
 axisymmetric elements, 520
 plane elements, 516

Hygro-Thermal
 solid elements, 524

I

IAX4, 530, 677, 678
IAX6, 530
IAX6P, 534
Interface, 530, 534, 538, 543
IPM4, 530
IPM6, 530
IPN12P, 679, 680
IPN16P, 679, 680
IPN4, 530, 677, 678
IPN6, 530, 677, 678
IPN6P, 534
IS12, 538, 543, 679, 680
IS16, 538, 543, 679, 680
IS6, 538
IS8, 538
Isoflex Plates, 350, 354

J

JAX3, 437, 669
JF3, 433, 668
JL43, 452, 671
JL46, 457, 672
JNT3, 424, 666
JNT4, 447, 671
Joint Element Compatibility, 681
Joints, 428, 433, 437, 442, 457, 462,
682
JPH3, 428, 667
JSH4, 457, 672

JSL4, 462, 673

JXS3, 442, 670

K

Kirchhoff Beams, 142, 149, 157, 164

L

LFD2, 480, 674

LFS2, 483, 674

LFX2, 486, 674

LM2, 557

LM3, 557

LMS3, 554

LMS4, 554

Load types, 580

local axes

 standard joint element, 589

 standard line element, 589

 standard surface element, 589

LUSAS Element Types, 12

M

Mass Lumping in LUSAS, 617

membrane elements, 412, 417

Membranes, 417

Mid-side Node Centrality, 587

Mindlin Plates, 358

modelling reinforcement, 77

Moments of Inertia Definitions, 619

N

Newton-Cotes Integration Points, 609

Non-Structural Mass, 548, 551, 554, 557, 560

Numerically Integrated Beam Elements, 591

O

Output Notation for Principal Stresses, 615

Overview, 7

P

perforated thick plates, 357

PF12, 499, 674

PF12C, 509, 674

PF15, 499, 524, 674

PF6, 499, 674

PF6C, 509, 674

Phreatic, 572

Phreatic Surface 3D Elements, 574

PHS2, 572

PHS3, 574

PHS4, 574

PHT12, 524, 675

PHT16, 675

PHT6, 524, 675

pipes, 370, 377, 416

Plane Field, 489, 494

plane frames, 146, 154

Plane Strain Continuum, 221, 228, 235, 240, 246, 251

Plane Stress Continuum, 196, 203,
210, 216
Plates, 350, 354, 358
PM2, 548
PM3, 551
PN12, 300, 652
PN12L, 328, 652
PN12P, 341, 653
PN15, 300, 652
PN15K, 314
PN15P, 341, 653
PN6, 300, 652
PN6E, 335, 654
PN6L, 328, 652
pressure vessels, 370, 377

Q

QAX4, 257, 650
QAX4E, 281, 647
QAX4F, 293, 649
QAX4L, 270, 651
QAX4M, 264, 650
QAX8, 257, 287, 650
QAX8F, 293, 649
QF4, 350, 655
QFD4, 494, 674
QFD8, 494, 674
QHT4, 516, 675
QHT8, 516, 675
QHXT4, 520
QHXT8, 520
QM4, 560
QM8, 560
QNK8, 240, 643
QPK8, 210, 641

QPM4, 196, 641
QPM4E, 216, 642
QPM4M, 203, 641
QPM8, 196, 641
QPN4, 221, 643
QPN4E, 246, 646
QPN4L, 235, 644
QPN4M, 228, 643
QPN8, 221, 643
QPN8P, 251, 645, 648
QSC4, 354, 656
QSI4, 378, 662
QSL8, 391, 664
QTF8, 358, 657
QTS4, 400, 665
QTS8, 400, 665
QXF4, 489, 674
QXF8, 489, 674
QXHT4, 675
QXHT8, 675
QXK8, 275, 650

R

R2D2, 564
R3D3, 567
R3D4, 567
reinforced concrete, 77
Results Notation
 Key to Results Tables, 621
 Key to Slideline Results, 629
Rigid, 564, 567, 574
Rigid Surface 3D Elements, 567

S

SED, 629
Semiloof Beams, 171, 179
Semiloof Shells, 391
Shear Areas, 611
shell structures, 399
Shells, 364, 371, 378, 384, 391, 400
sign convention
 2d continuum element, 597
 2d engineering beam elements,
 593, 595
 grillage elements, 592
 standard bar element, 591
 standard beam eccentricity, 596
 standard beam element, 591
 standard field element, 602
 standard joint element, 602
 standard membrane element, 601
 standard plate element, 597
 thick shell eccentricity, 601
 thick shell element, 599
 thin shell eccentricity, 599
SMI4, 417, 659
Solid Continuum, 300, 307, 314, 321,
328, 335
Solid Continuum Crack Tip, 314
Solid Field, 499, 504, 509
space frames, 163, 170
space frames., 185
Space Membranes, 417
Standard 2D Continuum Element, 597
Standard 3D Continuum Element, 597
Standard Bar Element, 591
Standard Beam Eccentricity, 596
Standard Beam Element, 591
Standard Field Element, 602
Standard Joint Element, 602
 local axes, 589

Standard Line Element
 local axes, 589
Standard Membrane Element, 601
Standard Plate Element, 597
Standard Surface Element, 589
Strain energy density, 629
Structural Bars, 68, 73
Surface Mass Elements, 560

T

TAX3, 257, 650
TAX3E, 281, 647
TAX3F, 293, 649
TAX6, 257, 650
TAX6F, 293, 649
TAX6P, 287
temperature, 472
temperature distribution, 493
Tetrahedral, 321
TF10, 499, 674
TF10S, 504, 674
TF3, 350, 655
TF4, 499, 674
TFD3, 494, 516, 674
TFD6, 494, 674
TH10, 300, 652
TH10K, 314
TH10P, 341
TH10S, 321, 652
TH4, 300, 652
TH4E, 335, 654
thermal analysis, 498
Thermal Bars, 468, 472, 476
Thermal Links, 480, 483, 486
Thick Shell Eccentricity, 601

Thick Shell Element, 599
Thick Shell Nodal Rotation, 605
Thick Shells, 400, 665
Thin Shell Eccentricity, 599
Thin Shell Element, 598
THT10, 524, 675
THT3, 675
THT4, 524, 675
THT6, 516, 675
TM3, 560
TM6, 560
TNH10P, 653
TNK6, 240, 643
Torsional Constant, 612
TPK6, 210, 641
TPM3, 196, 641
TPM3E, 216, 642
TPM6, 196, 641
TPN3, 221, 643
TPN3E, 246, 646
TPN6, 221, 643
TPN6P, 251, 645, 648
Transforming Results Directions, 630
trusses, 76
TS3, 378, 662
TSL6, 391, 664
TSM3, 417, 659
TSR6, 384, 663
TTF6, 358, 657
TTS3, 400, 665
TTS6, 400, 665
two phase, 341
TXF3, 489, 674
TXF6, 489, 674
TXHT3, 520, 675
TXHT6, 520, 675
TXK6, 275, 650

U

UDL Loads on Shells, 585



LUSAS

LUSAS, Forge House, 66 High Street, Kingston upon Thames, Surrey, KT1 1HN, UK
Tel: +44 (0)20 8541 1999 | Fax: +44 (0)20 8549 9399 | info@lusas.com | www.lusas.com