

Arbitrary Section Property Calculation and Use

| | |
|--------------------------|--------------------------|
| For LUSAS version: | 20.0 |
| For software product(s): | All (except LT versions) |
| With product option(s): | None. |

Description

The section properties of an arbitrary shaped box section are to be computed prior to the section being used on a model. Section geometry is supplied as a DXF file.

Units of N, mm, t, s, C are used.

Objectives

The required output from the analysis consists of:

- Section properties of a box section

Keywords

2D, Inplane, Section Properties, Arbitrary Section, Box Section, Holes, Fibre locations.

Associated Files

Associated files can be downloaded from the user area of the LUSAS website.

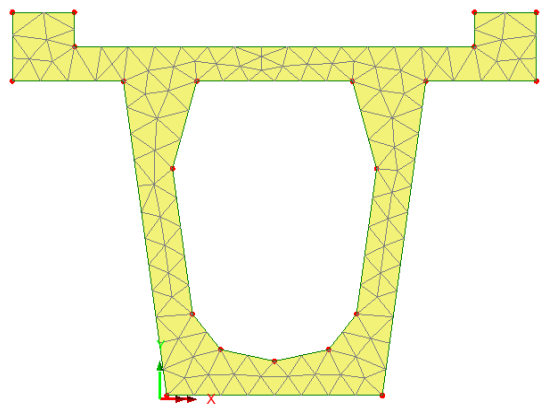



- ❑ **box_section.dxf** DXF file providing the section geometry.

Modelling

Running LUSAS Modeller

For details of how to run LUSAS Modeller, see the heading *Running LUSAS Modeller* in the *Introduction to LUSAS Worked Examples* document.





Note. This example is written assuming a new LUSAS Modeller session has been started. If continuing from an existing Modeller session select the menu command **File> New** to start a new model file. Modeller will prompt for any unsaved data and display the New Model dialog.

Creating a new model

- Enter a File name of **box_section**
- Use the default **User-defined** working folder.
- Ensure an Analysis type of **Structural** is set.
- Select an Analysis Category of **2D Inplane**
- Set Model units of **N,mm,t,s,C**
- Leave the Timescale units as **Seconds**
- Select a Startup template of **None**.
- Ensure the Layout grid is set as **None**
- Enter a Title of **Box Section**
- Click the **OK** button.

Discussion

The arbitrary section property calculator within LUSAS Modeller allows a user-defined section to be drawn (or imported) and properties for that section to be calculated during the creation of any model. In doing so, a section utility is created in the Utilities  Treeview and the ability to create a corresponding geometric line attribute in the Attributes  Treeview is provided. This attribute can be assigned directly to selected lines in a model.

The calculator itself computes the section properties of any open or closed section. Cross-sections are created either as a single regular or irregular surface, or as a group of

surfaces (including holes). Fibre definitions (positions on the cross-section at which stresses or values can be plotted when viewing results) are also created for each drawn section at the time of section property calculation.

Accessing the Arbitrary Section View Window

Utilities

Section Property

Calculator

Arbitrary section...

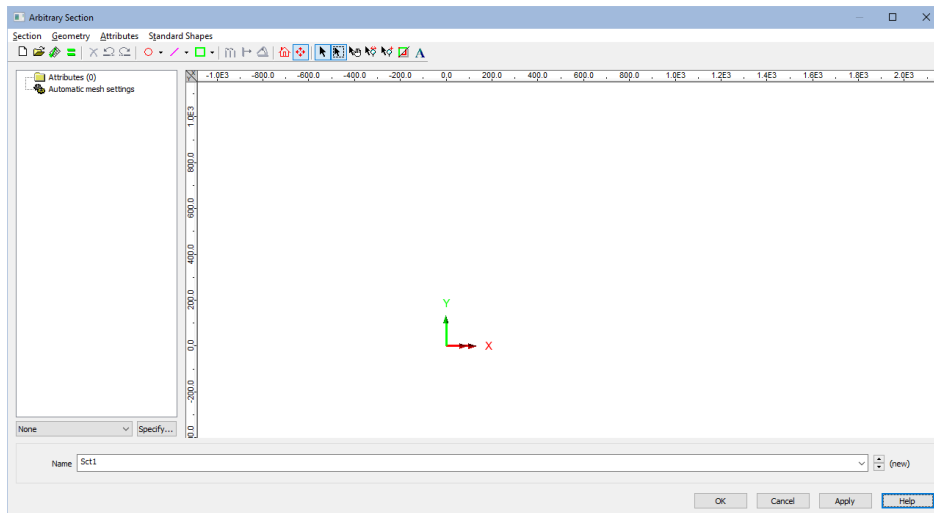

The arbitrary section view window contains a reduced set of menu items and toolbar buttons from the main Modeller window that are suitable for creating and manipulating user-defined sections.



Caution. 2D cross-sections for section property calculation must be defined in the XY plane.



Note. All menu commands that follow are for selection inside the Arbitrary Section window, and not the main User Interface.

Feature Geometry

- Set the **Files of type** drop-down menu to **DXF Files (*.dxf)**
- Locate the **box_section.dxf** file that was downloaded and placed in a folder of your choosing and click the **Import** button to read in the DXF file and create the cross-section geometry as shown below.

Defining holes within a section

This is done by first defining a surface that represents the total extent of the box-section, then defining a surface that represents the void or hole, and then selecting both the surrounding and inner surface to create the hole in the bounding surface.

Section

Import...

Arbitrary Section Property Calculation and Use

- Drag a box around the whole model

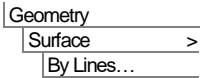
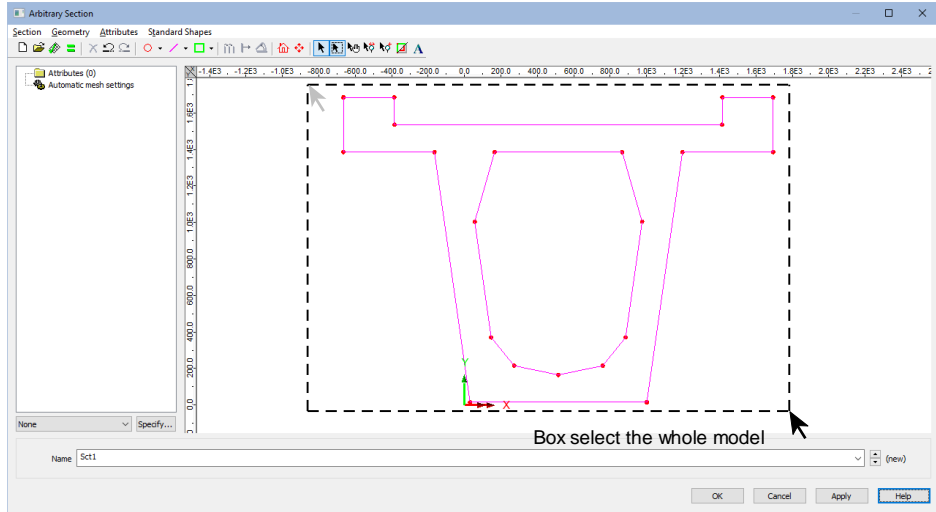

Click the **OK** button to create a **General Surface** (for the outer surface) from the selected Lines.

- Now, drag a box around the only the lines defining the void.



Click the **OK** button to create a **General Surface** (for the inner surface) from the selected Lines.

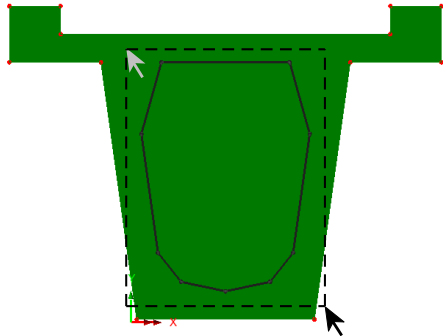

Box select the lines defining the void

- Select the outer Surface of the box-section, then hold the **Shift** key down, and select the inner Surface representing the void.

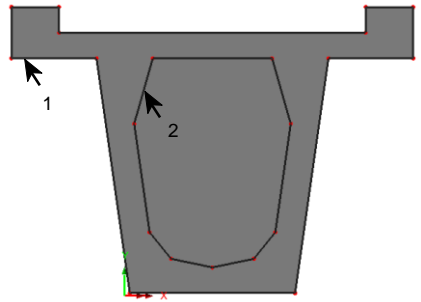

Select the two surfaces

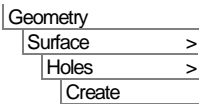

- On the Create Holes dialog, ensure the option **Delete geometry defining holes** is selected, and click **OK**.

A new singular Surface will be created, containing a void. This can be seen by clicking in an empty region of the view window to deselect all features, and then clicking inside the outer perimeter of the box section and seeing that all lines are selected.

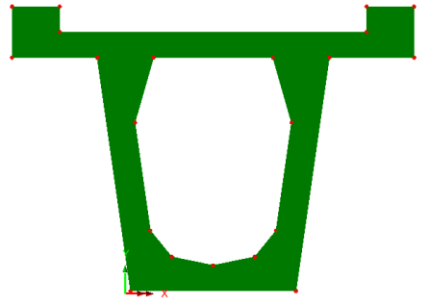

Name the section

Sections are saved with the model in which they are defined, and with the section name stated.

- At the bottom of the Arbitrary Section window, enter a name of **dx_f_box_section**.

Calculate section properties

The section properties will then be calculated and shown on the Section Details dialog. Centroid, Shear Centre and Plastic Neutral Axis symbols and locations are also shown.

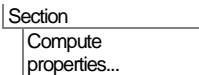

Arbitrary Section Property Calculation and Use

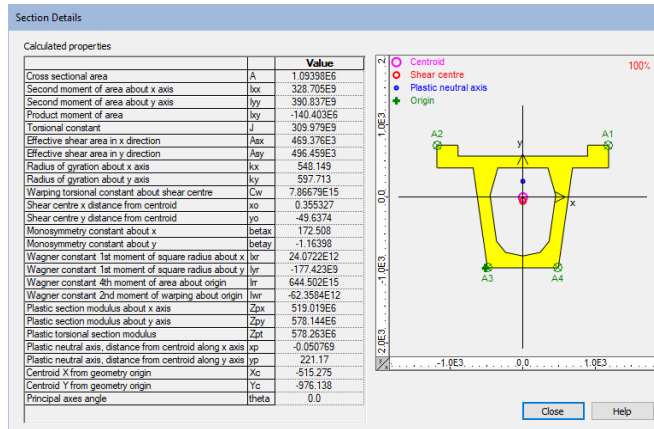

Note. There is no need to compute the section properties in the units they are to be used in the analysis model because conversion of units is carried out when the section properties are extracted from the section library if it is found to be required.

- After viewing the properties, click the **Close** button. The mesh used to calculate the section properties is now shown on the model in the Arbitrary Section window.

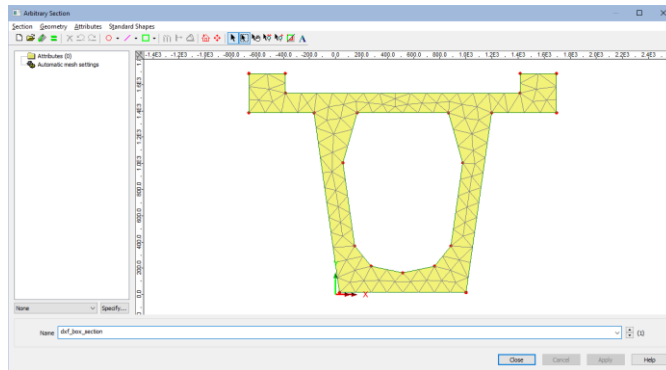

Note. By default, an element size is selected which will assign 15 elements to the longest side and a minimum of 2 elements is applied to the shorter sides. This mesh may be adjusted by selecting 'Automatic mesh settings' in the Arbitrary Section treewiew prior to computing section properties.



As with all finite element models the more elements used the more accurate the results but the slower the calculation. A good compromise of 2 elements across all thin sections has been found to provide reasonable results without using excessive computation time.

- On the Arbitrary Section property window click **OK**.

A **dx_f_box_section** utility has now been added to the Utilities  Treeview.

Notes on defining and using arbitrary sections

When accessing the arbitrary section property calculator from the **Utilities > Section Property Calculator** menu item (as done here), on completion using this method of accessing the tool, only a utility is created in the Utilities  Treeview, and this will need to be selected in order to define a geometric line attribute for subsequent assignment to selected lines in a model.

The Arbitrary Section Property Calculator can also be accessed from the **Attributes > Geometric > Section Calculators** menu item, or from the **Attributes > Geometric > Section Library Item**. On completion, using these methods of accessing the tool, a section utility is created in the Utilities  Treeview and the ability to create a corresponding geometric line attribute in the Attributes  Treeview is provided. This attribute can be assigned directly to selected lines in a model.

How to access arbitrary sections from the section library



Note. All menu commands that follow are for selection inside the main User Interface, and not the Arbitrary Section window.

When defining sections for use within a current model (as in this case):

- Select **Arbitrary Sections** from the top-right drop-list on the dialog.
- In the lower drop-list, browse for and select the **dx_f_box_section** name. The section shape will be visualised, showing defined fibre locations.

Fibre locations are used to calculate beam stress results for plotting force and moment diagrams. LUSAS automatically creates one for every extreme point on a section.

Note that eccentricity values can be defined here for sections, when appropriate

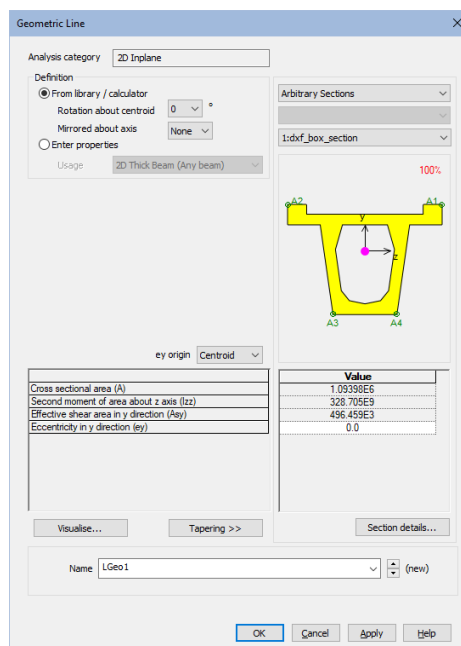
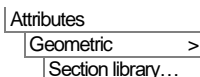

Arbitrary Section Property Calculation and Use

- On the Geometric Line dialog, press the **Section details** button.
- On the Section Details dialog, select the **Fibre locations** tab. The calculated extreme fibre locations can be seen.

Note that additional fibre locations can be added manually to the library item by clicking in the Fibre locations area and pressing the **TAB** key until a new line is created, and then entering the coordinate of the fibre location required.



Tip. If additional fibre locations are required on the section use Modeller to obtain the properties of any additional points on the saved model and enter the point coordinates in the manner described above. Note that if invalid coordinates are used the fibre location will be added to the nearest point on the outer perimeter of the section.

| | Fibre name | Distance from centroid, z | Distance from centroid, y |
|---|------------|---------------------------|---------------------------|
| 1 | A1 | 1.17963E3 | 709.205 |
| 2 | A2 | -1.18037E3 | 709.205 |
| 3 | A3 | -484.75 | -960.795 |
| 4 | A4 | 485.25 | -960.795 |
| 5 | | | |

- Press **OK** to save changes and return to the Geometric Line dialog.
- Finally, to add the arbitrary section to the Attributes  Treeview (ready for assignment to selected lines representing beams in the model) press the **OK** button.

This completes the example.



Note. A Box Section Property Calculator is provided in Bridge and Civil & Structural software products and allows for generating solid or voided sections of a type typically used in precast and segmentally constructed bridges.