

Damage Analysis of a Composite Plate

For LUSAS version:	20.0
For software product(s):	LUSAS Composite Plus
With product option(s):	Nonlinear.
Note: The example exceeds the limits of the LUSAS Teaching and Training Version.	

Description

A 1mm thick composite plate made up from an IM Carbon cross ply laminate is placed under tensile loading to analyse the damage growth and stress redistribution around a stress concentration caused by a 10mm diameter hole. Because of symmetry a quarter model will be created.

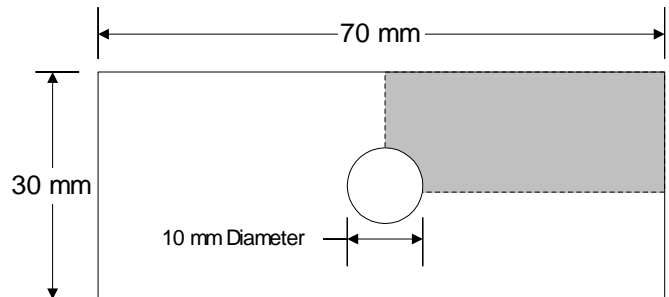

Units used are N, mm, t, s, C throughout.

Objectives

The objective of the analysis is:

- To determine the onset of damage growth
- To predict the effect of damage growth on the stress distribution within the composite stack

Keywords

3D, Composite, Hashin, Damage, Nonlinear

Associated Files

Associated files can be downloaded from the user area of the LUSAS website.



- composite_plate_modelling.lvb** This file carries out the modelling of the example.

Modelling

Running LUSAS Modeller

For details of how to run LUSAS Modeller, see the heading *Running LUSAS Modeller* in the *Introduction to LUSAS Worked Examples* document.



Note. This example is written assuming a new LUSAS Modeller session has been started. If continuing from an existing Modeller session select the menu command **File>New** to start a new model file. Modeller will prompt for any unsaved data and display the New Model dialog.

Creating a new model

- Enter the filename as **composite_plate**
- Ensure an Analysis type of **Structural** is set.
- Set the Analysis category to be **3D**
- Set the model units as **N,mm,t,s,C**
- Ensure that timescale units are **Seconds**
- Select the Startup template **Composite**
- Ensure the Layout grid is set as **None**
- Enter the title as **Damage Analysis of Composite Plate**
- Click the **OK** button.



Note. Save the model regularly as the example progresses. Use the Undo button to correct any mistakes made since the last save was done.

Feature Geometry

The composite plate will be modelled as a quarter model and symmetry boundary conditions will be used to reduce the size of the model. Firstly the hole will be defined.

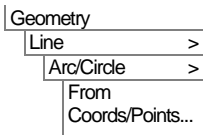

- Enter coordinates of **(5, 0)**, **(0, 5)** and **(0, 0)**
- Select the **Centre** option next to the **(0, 0)** coordinate entry and click the **OK** button.

Now define the lines representing the edges of the specimen.

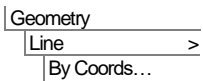

 Enter coordinates of **(35, 0)**, **(35, 15)** and **(0,15)** and click the **OK** button.

Now create the lines on the symmetry planes.

- Select the two points on the horizontal plane of symmetry

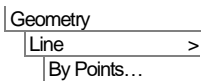
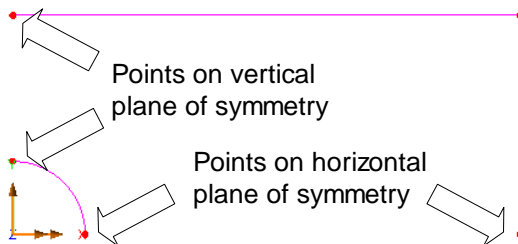

 Create a line along the horizontal line of symmetry.

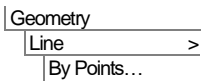

- Select the two points on the vertical plane of symmetry.



 Create a line along the vertical line of symmetry.



Now create a surface from the boundary lines.

- Change the selection mode so only Lines are selected from the display. Click and hold the left-hand mouse button on the selection button , then click on the  button to select only lines.
- Box-select all the lines in the model by clicking and dragging the cursor around all the lines that form the surface.

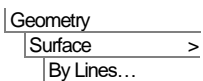



 Create a **general surface** from the selected lines.

- Change the selection mode back to the default pointer  and click in a blank area of the view window to deselect any selected features.

Meshing

In this example the mesh will be graded manually by specifying the number of elements on each of the boundary lines. The mesh pattern will not be visible until a volume mesh assignment has been made.

Define a null line mesh with 16 divisions.

- Enter **16** in the number of divisions.
- Enter the dataset name as **Null, divs = 16** and click the **OK** button.
- Use the **Ctrl** and **A** keys together to select all the features and assign **Null, divs = 16** from the  Treeview to all lines.
- Select the upper horizontal line representing the edge of the plate and assign the line mesh dataset **Null, divs = 8** from the  Treeview. This will overwrite the previous assignment.
- Select the line on the right hand side of the model and assign **Null, divs = 2** from the  Treeview. This will overwrite the previous assignment.

Creating a volume

The surface will now be swept through the depth of the plate to create a volume. Lines on the newly created surface on the back face of the volume will automatically inherit the line mesh dataset from the swept surface. The lines through the depth will however adopt the default number of mesh divisions. Since one element only is required through the depth of the plate the default number of mesh divisions must be set to one.

- Select the **Meshing** tab.
- Change the default number of mesh divisions to **1** and click **OK**

Now the volume that represents a quarter of the plate can be created.



Rotate the model to an isometric view to see the volume created.

- Select the Surface (use the **Ctrl** and **A** keys together to select whole model).



Sweep the surface to form a volume.

- Enter a translation in the Z direction of **1** and click the **OK** button.

Now we assign a mesh to the volume. Because it is not a regular volume, a transition mesh is required.

- Double click on the mesh dataset **Composite Brick (HX16L)** and select the **Allow transition pattern** option.



Note. Transition meshing is required to enable the five sided surface to be modelled predominantly with quadrilaterals. When using transitional meshing Modeller will introduce compatible triangular elements as necessary.

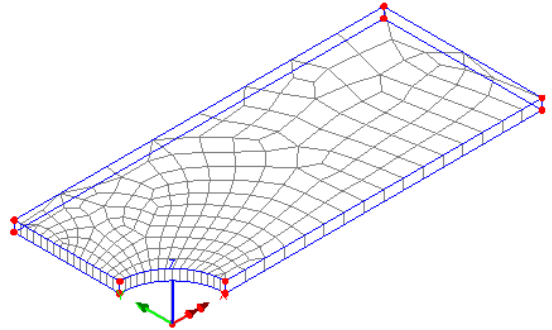

- Click **OK** to change the mesh dataset.
- Use the **Ctrl** and **A** keys to select the whole model and assign the mesh dataset **Composite Brick (HX16L)**
- Click on **Z: N/A** to return the model to the default view from the Z axis.

Material Properties

Properties of a number of the more commonly used composite materials are available from the composite library. The plate in this example is made up from a four layer stack of IM Carbon UD.

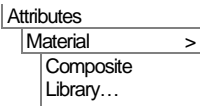

- Select the material **IM Carbon UD Vf=60%** from the drop down list.
- Ensure the option for **3D Solid** is chosen.
- Select the option to output parameters for the **Hashin damage model**

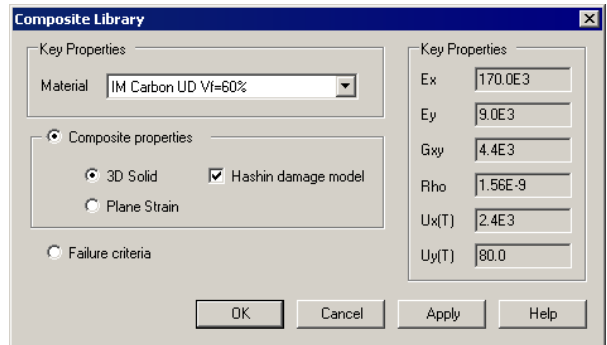

- Click the **OK** button to add the selected composite material properties to the Treeview.

Defining the Composite Stack

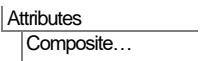

- Select the **Solids and Shells** option and click **Next**
- Select the **New** button.

The Add Lamina dialog will appear.

Defining lamina 1

The Name for the first lamina will be automatically entered as **Lamina1**

The material will automatically be entered as **1:Orth` (IM Carbon UD Vf=60% - Hashin Damage)**

- Leave the thickness as **1** and the angle as **0**
- Click the **Apply** button to define the lamina and create a second lamina.

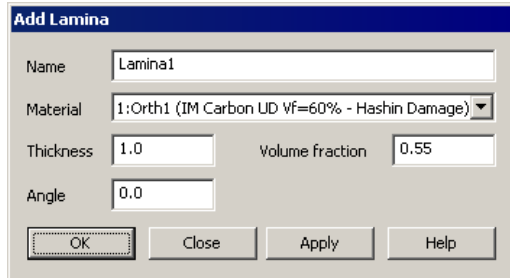

Defining lamina 2

- **Lamina2** will be automatically entered for the lamina name
- Leave the thickness as **1** but change the angle to **90**
- Click the **OK** button.

Define a symmetrical stack

- Select the **Symmetric** button to generate a four layer stack.
- Enter the dataset name as **Laminate Stack** and click the **Finish** button.

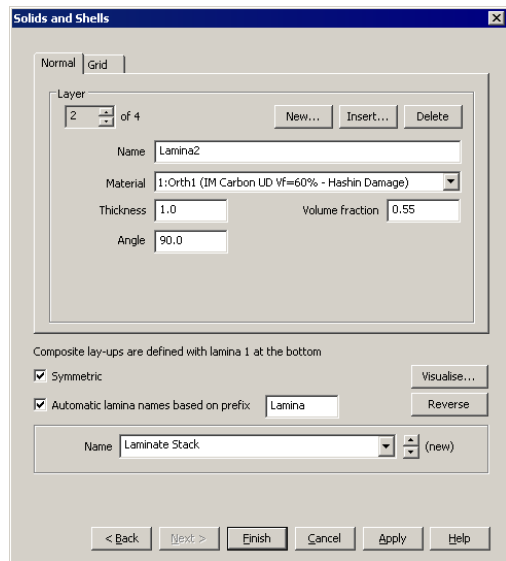

Note. The lamina thickness values to be entered for solid models comprised of Pentahedral or Hexahedral composite elements are relative values, not absolute real thicknesses, and represent the proportion of the total thickness (as specified by geometric properties) apportioned to each lamina. In other words, for solid models comprised of Pentahedral or Hexahedral composite elements the sum of all the specified lamina thicknesses will always occupy the geometric thickness defined.

Assigning the Composite Stack

The composite stack now needs to be assigned to the volume so that the zero fibre directions run along the length of the plate. To do this, a local coordinate system is



defined such that the local axes defined correspond to the global axes. The composite stack is then assigned relative to this local coordinate system.

Attributes
Local Coordinates...

- Ensure a Rotate Angle of **0** about the **Z-axis** is set. Enter the dataset name as **Global** and click the **OK** button.
- Use **Ctrl** and **A** keys together to select the whole model and from the  Treeview drag and drop the composite dataset **Laminate Stack** onto the selected features.
- On the Assign Composite dialog ensure **Assign to Volumes** is selected. Select the **Local Coordinate** option, ensure the dataset **Global** appears in the drop down list and click the **OK** button.

Visualising lamina directions

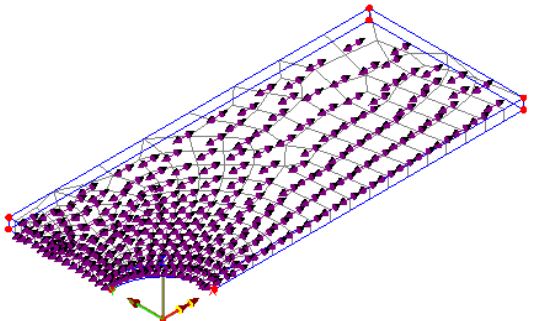
Now the laminate stack is assigned to the model the lamina orientation can be checked by visualising the lamina directions.

- In the  Treeview click on **Attributes** with the right hand mouse button and select **Properties**
 - Select the **Composite** tab, then select the **All** datasets option.
 - Click on the **Settings** button.
 - On the Visualisation Settings dialog select the **Visualise ply directions** option and ensure Surface position **Middle** and Axis **x** are selected.
 - Click the **OK** button to return to the Attribute properties.
 - Click the **OK** button to visualise the layer directions.
- 
- In the  Treeview, in the Composite Laminate Stack section right-click on **Lamina 2** and select the **Set Lamina Active** option.
 - Other lamina directions may be checked by setting each lamina active in turn.
 - Turn off visualisation of ply directions by going to the  Treeview clicking on **Laminate stack** with the right hand mouse button and de-selecting **Visualise assignments**.

Supports

Symmetry supports need to be assigned to the lines of symmetry of the model. This is best done by viewing the plate from above.

- Click on to return the model to the default view from the Z axis.

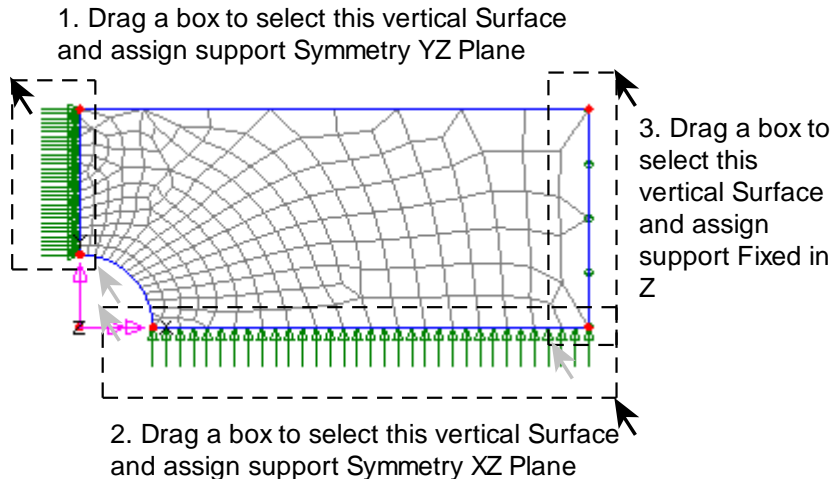

- Drag a box around the Surface on the vertical axis of symmetry.
- Drag and drop the support dataset **Symmetry YZ** from the Treeview.
- Ensure the **Assign to surfaces** option is selected and click **OK** to assign the support dataset.
- Similarly drag a box around the Surface on the horizontal axis of symmetry and assign the support dataset **Symmetry XZ** from the Treeview to it.

The model also needs to be restrained from moving in the out of plane direction.

- Drag a box around the Surface on the right hand side of the model and assign the support dataset **Fixed in Z** from the Treeview.

Loading

The plate is to be placed under a tensile loading using a prescribed displacement.

- Select the **Prescribed Displacement** option and click **Next**
- Enter a **Total** displacement in the X direction of **0.1**.

Attributes
Loading... >

- Enter a dataset name of **Prescribed Displacement** and click the **Finish** button.
- Drag a box around the Surface defining the right hand end of the plate and assign the dataset **Prescribed Displacement** from the  Treeview.
- Click **OK** to assign to **Analysis 1** and **Loadcase 1**.



Select the isometric view button and check the supports and loading have been applied as shown in this image.

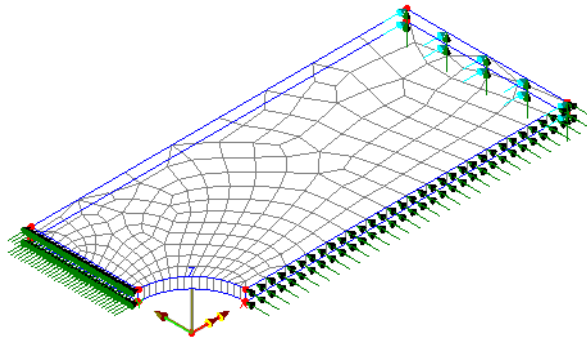

Analysis Control

Because this is a nonlinear problem the load incrementation strategy needs to be defined.

- From the  Treeview expand **Analysis 1** right-click on **Loadcase 1** and from the **Controls** option select the **Nonlinear & Transient** option.

The Nonlinear & Transient dialog will appear.

- Select the **Nonlinear** option.
- Set Incrementation to **Automatic**
- Set the Starting load factor to **0.5**
- Set the Maximum change in load factor to **0.25**
- Set the Maximum total load factor as **1**
- In the Solution strategy panel change the Incremental displacement norm to **100** as convergence is to be monitored on the residual norm only.
- Leave the Maximum number of time steps or increments as **0** as this ensures the solution will continue until the maximum load is reached.

Nonlinear & Transient

Incrementation

Nonlinear

Incrementation: Automatic

Starting load factor: 0.5

Max change in load factor: 0.25

Max total load factor: 1.0

Adjust load based on convergence

Iterations per increment: 4

Displacement reset

Solution strategy

Same as previous loadcase

Max number of iterations: 12

Residual force norm: 0.1

Incremental displacement norm: 100.0

Incremental LUSAS file output

Same as previous loadcase

Output file: 1

Plot file: 1

Restart file: 0

Max number of saved restarts: 0

Log file: 1

History file: 1

Save a restart at the end of this control

Time domain

Time domain

Consolidation

Initial time step: 0.0

Total response time: 100.0E6

Automatic time stepping

Common to all

Max time steps or increments: 0

OK Cancel Help

- Click the **OK** button to finish.

To avoid mechanisms in the element formulation when some of the Gauss integration points fail, it is necessary to switch on fine integration for the elements.

- Select the **Options** tab and click on the **Element options** button. Ensure that **Fine integration for stiffness and mass (structural)** is selected and click **OK**. Click **OK** to finish.

Saving the model



Save the model file.

File
Model Properties...

File
Save

Running the Analysis



Open the **Solve Now** dialog and press **OK** to run the analysis.



Note. In running this nonlinear analysis a number of load increments are evaluated. An indication of the time remaining can be obtained by observing the number of the increment being evaluated.

A LUSAS Datafile will be created from the model information. The LUSAS Solver uses this datafile to perform the analysis.

If the analysis is successful...

Analysis loadcase results are added to the  Treeview.

In addition, 2 files will be created in the Associated Model Data directory where the model file resides:



- composite_plate.out** This output file contains details of model data, assigned attributes and selected statistics of the analysis.
- composite_plate.mys** This is the LUSAS results file which is loaded automatically into the Treeview to allow results processing to take place.

If the analysis fails...

If the analysis fails, information relating to the nature of the error encountered can be written to an output file in addition to the text output window. Any errors listed in the text output window should be corrected in LUSAS Modeller before saving the model and re-running the analysis.

Rebuilding a Model

If it proves impossible for you to correct the errors reported a file is provided to enable you to re-create the model from scratch and run an analysis successfully. You may download this file from the user area of the LUSAS website.



- composite_plate_modelling.vbs** This file carries out the modelling of the example.

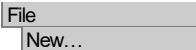

 Start a new model file. If an existing model is open Modeller will prompt for unsaved data to be saved before opening the new file.

- Enter the file name as **composite_plate**
- Use the default **User-defined** working folder.
- Ensure an Analysis category of **3D** is set.
- Click the **OK** button.



Note. There is no need to enter any other new model details when a script is run to build a model, since the contents of the script will overwrite any other settings made.

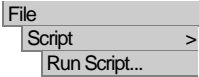

To recreate the model, select the file **composite_plate_modelling.lvb** that was downloaded and placed in a folder of your choosing.



Rerun the analysis to generate the results.

Viewing the Results

Loadcase results for each increment can be seen in the  Treeview. For a nonlinear analysis the last solved increment will be set active by default.



If necessary, select the isometric view button.

- If present, turn off the **Geometry** and **Attributes** layers in the  Treeview.

Stress Contours

- In the  Treeview ensure the final load increment **Increment 3 Load Factor = 1** is **Set Active**

For solid models the lamina results can be selected for the top, middle or the bottom of any selected lamina. For this example the middle of selected laminae will be viewed. By default LUSAS will automatically transform results into the material direction.

- With no features selected click the right-hand mouse button in a blank part of the view window and select **Contours** to add the contours layer to the  Treeview.

The contour Properties dialog will be displayed.

- Select entity results of **Stress Solids - lamina (middle)** of component **Sx** and click the **OK** button.
- In the  Treeview expand the **Composite Strip** layup entry and right-click on the **Lamina1** and **Set Lamina Active**

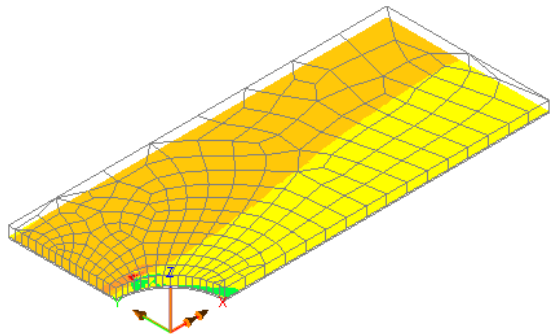

The contour key should be showing a maximum stress in the lamina X material direction of around 1.8E3

- By re-ordering the layers in the  Treeview the mesh can be viewed on top of the contour results.



Note. When displaying layer contours the contours are displayed at the layer position through the thickness of the model.

- In the  Treeview, in the Composite Laminate Stack entry, right-click on **Lamina2** and **Set Lamina Active**

The contour key should be showing a maximum stress in the lamina X material direction of $1.6e3$

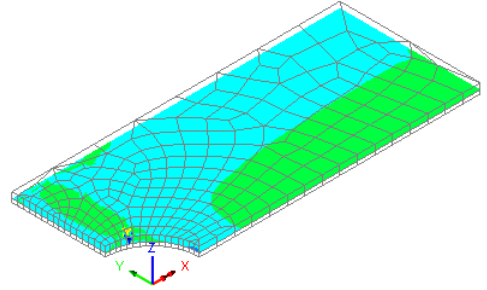

Failure Contours

When using the Hashin failure model the failure indicator (IFFLR) can be contoured. The indicator has the following values:

Indicator (IFFLR)	Description
0-1	No failure
1-2	Matrix failure
2-3	Fibre failure
3+	Matrix and fibre failure

To display contours of the failure index for layer 2:

- Double-click the **Contours** layer name in the  Treeview.

The contour Properties dialog will be displayed.

- Select entity results of **Stress Solids – lamina (middle)** of component **IFFLR**.
- Select the **Appearance** tab, and for the **Classic** contour press the **Set** button.
- Set the contour interval to **1**.
- Set the maximum contour value to **3**

Damage Analysis of a Composite Plate

- Set the minimum contour value to **1** click **OK**
- Click **OK** again to display contours of Hashin failure in the material fibre direction for Lamina 2.

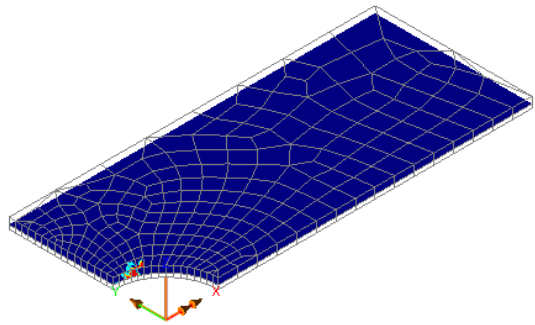

- By zooming in the region of failure can be seen in more detail.

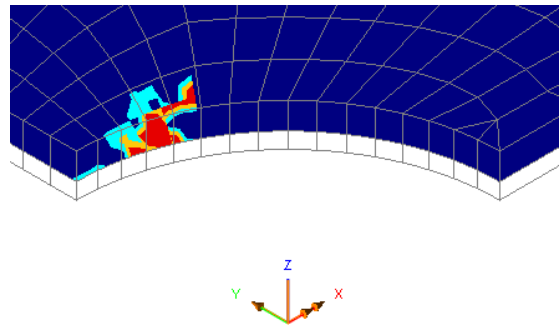

- By changing the active loadcase it can be seen that no failure has occurred after the first load increment (a load factor of 0.5). By the second load increment (a load factor of 0.75) a small amount of matrix failure has occurred adjacent to the hole.

This completes this example.