

Linear Analysis of a 2D Frame

For LUSAS version:	20.0
For software product(s):	LUSAS <i>Civil & Structural</i> LT and above, or LUSAS <i>Bridge</i> LT and above
With product option(s):	None.

Description

A simple 2D frame is to be modelled and analysed. The geometry of the frame is as shown.

All members are made of mild steel.

The structure is subjected to two loadcases; the self-weight of the structure, and a sway load at the top of the left-hand column.

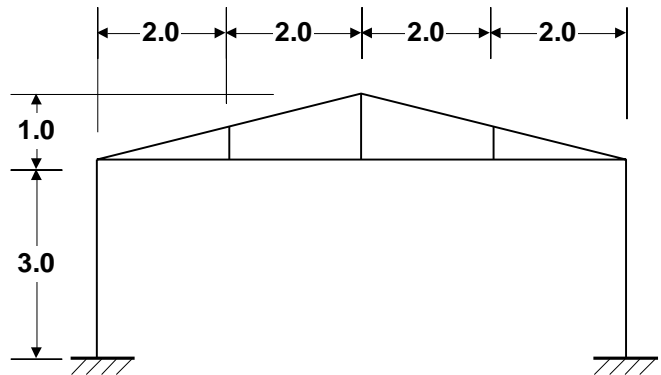

The units of the analysis are N, m, kg, s, C throughout.

Objectives

The required output from the analysis consists of:

- A deformed shape plot showing displacements caused by the imposed loading.
- An axial force diagram showing stresses in the members.

Keywords

2D, Frame, Beam, Standard Sections, Fleshing, Copy, Mirror, Deformed Mesh, Axial Force Diagram, Shear Force Diagram, Bending Moment Diagram, Fibre Results, Saved view, Generating a Report, Printing Results.

Associated Files

Associated files can be downloaded from the user area of the LUSAS website.



- ❑ **frame_2D_modelling.lvb** carries out the modelling of the example.

Modelling

Running LUSAS Modeller

For details of how to run LUSAS Modeller, see the heading *Running LUSAS Modeller* in the *Introduction to LUSAS Worked Examples* document.



Note. This example is written assuming a new LUSAS Modeller session has been started. If continuing from an existing Modeller session select the menu command **File>New** to start a new model file. Modeller will prompt for any unsaved data and display the New Model dialog.

Creating a New Model

- Enter a file name of **Frame_2D**
- Use the default **Recent** working folder.
- Ensure an Analysis type of **Structural** is set.
- Set an Analysis Category of **2D Inplane**
- Set Model units of **N,m,kg,s,C**
- Ensure Timescale units are in **Seconds**
- Select a Startup template of **2D Frame**.
- Ensure the Layout grid is set as **None**

The screenshot shows the 'New Model' dialog box with the following settings:

- File name: Frame_2D
- Working folder: Recent (B:\changerequests\cr30000-39999\cr30188)
- Model properties:
 - Analysis type: Structural
 - Analysis category: 2D Inplane
 - Model units: N,m,kg,s,C
 - Timescale units: Seconds
- Optional:
 - Startup template: 2D Frame
 - Layout grid: None
 - Title: 2D Frame
 - Job number: (empty)

- Enter a Title of **Simple 2D Frame**
- Click the **OK** button.

The Attributes  treeview will be populated with potentially useful basic line mesh, geometric and support entries appropriate to the settings made on the new model dialog.



Note. The Undo button  may be used to correct a mistake. The undo button allows any number of actions since the last save to be undone.

Feature Geometry

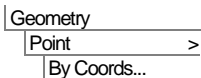



 Enter coordinates of **(0, 0)**, and after pressing the **Tab** key to move to the next entry field on the dialog, enter additional points of. **(0, 3)**, **(4, 3)** and **(4, 4)**. These define the main setting-out points for one-half of the portal frame. With all the coordinates entered click the **OK** button.

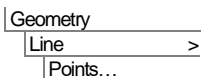

Note. Sets of coordinates must be separated by commas or spaces unless the ‘Grid Style’ method is chosen.

- Select the two Points on the left-hand side of the model.



 Connect the selected Points with a Line representing the left-hand column of the portal frame.

- Select the pairs of Points on the right hand side of the model.

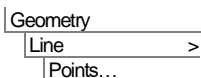

 Connect the selected Points with a Line representing the right-hand vertical member on the frame centreline.

- Create the horizontal member by selecting the appropriate Points and define a Line in a similar manner.
- Select the Point at the top of the left hand column, then Hold down the **Shift** key to add the point at the apex of the roof to the selection.

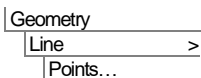

 Connect the selected Points with a Line representing the sloping member of the frame.

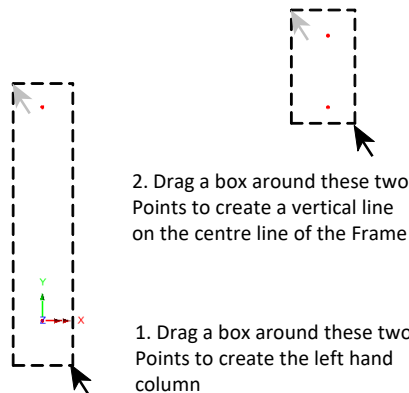

Linear Analysis of a 2D Frame

To create the vertical roof member at quarter span the two lines shown are split into equal divisions to create the points required and the new line is then defined.

- First select the lower line and then select the upper line as shown (Hold down the **Shift** key to add the second Line to the initial selection).
- Enter the number of divisions for both Lines as **2**
- Ensure that **Delete original geometry after splitting** is set so that the original Lines are deleted and click the **OK** button.
- Drag a box around the 2 Points just created.

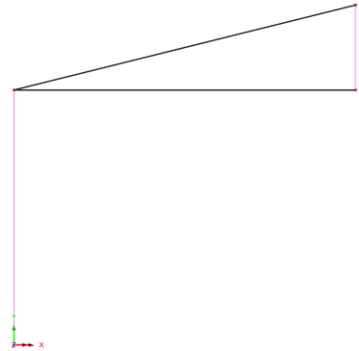



 This creates the Line representing the internal member.

This completes the geometry definition for the half-frame.

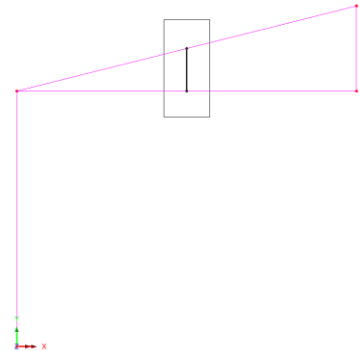
Model attributes (mesh, material, geometric properties etc.) now need to be defined and assigned to the model.



Note. LUSAS Modeller works on a define and assign basis where attributes are first defined, then assigned to features of the model. This can be done either in a step-by-step fashion for each attribute or by defining all attributes first and then assigning all in turn to the model.

- Attributes, once defined, are displayed in the  Treeview. Unassigned attributes appear as a grey colour.
- Attributes are then assigned to features by dragging an attribute dataset from the  Treeview onto features previously selected in the model view window.

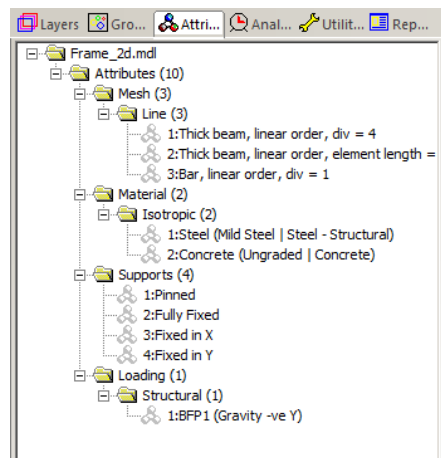

The  panel shows a variety of attributes that were defined as a result of selecting the 2D Frame template.



Tip. Useful commands relating to the manipulation of attributes can be accessed by selecting an attribute in the  Treeview, then clicking the right-hand mouse button to display a shortcut menu.

Meshing

The Line features are to be meshed using two-dimensional beam elements. A 2D thick beam element is automatically provided in the Attributes  Treeview but to show the process involved another will be defined:

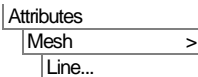



- Select **Thick beam, Linear** elements.
- Set the number of divisions to be **1**
- Enter the attribute name as **Thick Beam** then click **OK**
- Select the whole model. (press the **Ctrl** and **A** keys together).
- Drag and drop the mesh attribute **Thick Beam** from the  Treeview onto the selected model Lines.



Note. When an assignment is made confirmation of the assignment is written to the Text Output Window. Note also that when mesh is assigned to line beams the mesh colour occludes the line colour to show which features have been meshed.

Material Properties

Steel of the required grade is already present in the Attributes  Treeview.

- With the whole model selected (**Ctrl** and **A** keys together) drag and drop the material attribute **Steel (Mild Steel | Steel - Structural)** from the  Treeview onto the selected features.

Geometric Properties

The standard sections dialog will appear.

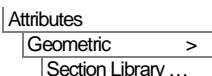

- Select the library of **UK Sections**

Linear Analysis of a 2D Frame

- Select section type **Universal Beams (BS4)**
- Select section name **127x76x13kg UB**.
- Enter the Attribute name as **stanchion**.
- Click the **Apply** button to add the Universal Beam attribute to the  Treeview.
- Change the library to **EU Sections**.
- Change the section type to **Equal Angles**, and select the **70x70x6 EA** section name.
- Enter the Attribute name as **roof member**

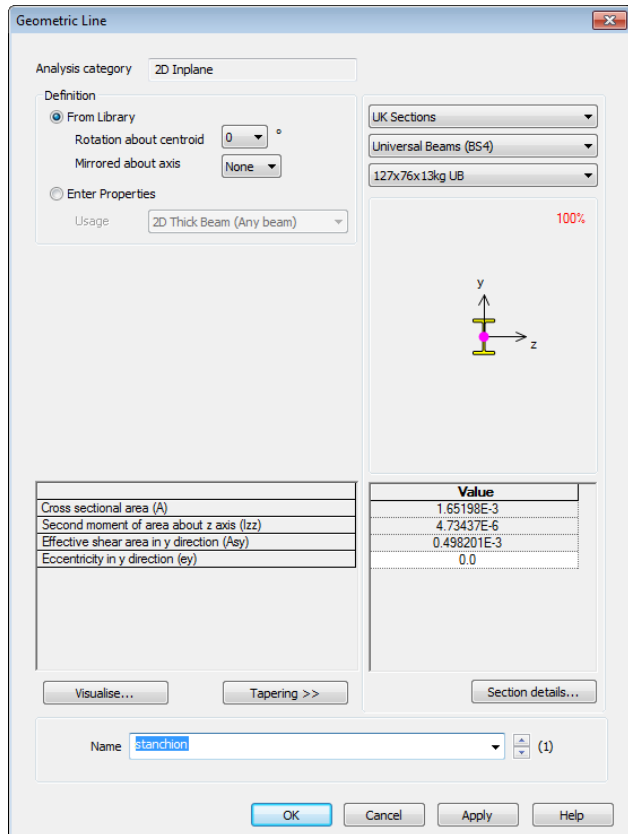



- Click the **OK** button to add the Equal Angle attribute to the  Treeview.



Note. The Treeview name given to the attribute consists of the stated name followed by the library section name, and the orientation of the section (only if rotated) in parentheses. Only the stated name can be renamed.

Assigning Geometric Properties

- Select the Line representing the left-hand vertical member.
- Drag and drop the geometry attribute **Stanchion (127x76x13kg UB)** from the  Treeview onto the selected Line.
- Drag a box around the Lines representing the roof members.
- Drag and drop the geometry attribute **Roof member (70x70x6 EA)** from the  Treeview onto the selected Lines.

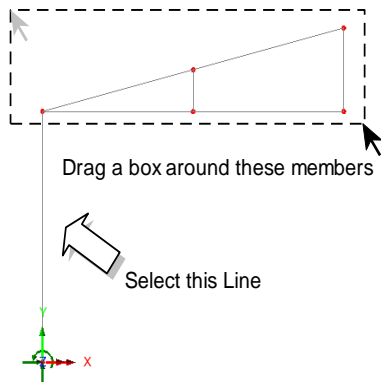

Geometric assignments are visualised by default.

- Click in a blank part of the View Window to deselect the members.



Select the isometric button to see the geometric visualisation on the members.



The Zoom in button can be used to check the orientations.



Select the Home button to return the model to the default view.



Select the fleshing on/off button to turn-off the geometric visualisation.

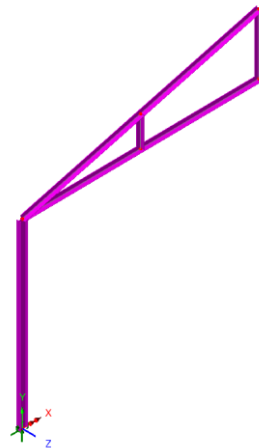

Supports

LUSAS provides the more common types of support by default. These can be seen in the  Treeview. The structure will be supported at the end of the stanchion which is in contact with the ground with a fully fixed support condition.

Assigning the Supports

- Select the Point at the bottom of the left-hand vertical member.

Linear Analysis of a 2D Frame

- Drag and drop the support attribute **Fully Fixed** from the  Treeview onto the selected feature.
- Ensure the **Assign to points** and **All analysis loadcases** options are selected and click **OK**

Mirroring the Model

One half of the 2D frame has now been generated. This half can now be copied about a mirror plane to create the complete frame.

- Select the whole model (**Ctrl** and **A** keys together).

 Select **Mirror (screen)** and choose **Right** to mirror the selection about the rightmost line of those selected.

 **Note.** Items selected for mirroring about the screen axes are represented by black lines on the dialog, with the effect of the mirroring setting chosen being shown in default feature colours, above, below, to the left, or to the right of the selection.

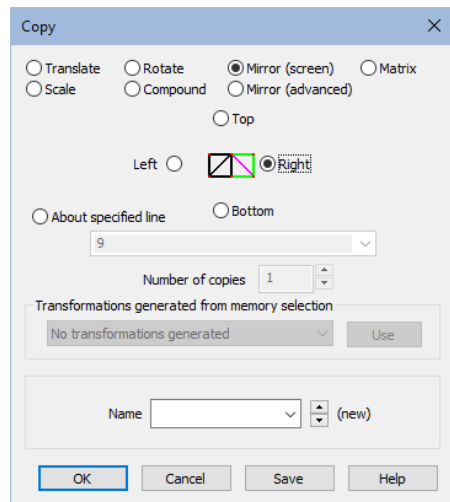

- Click the **OK** button to create the full model.

 **Note.** Features that are copied retain their attributes. This means that there is no need to define the mesh, material or geometric properties for the newly created Lines as they will already have the attributes from the original half of the model assigned.

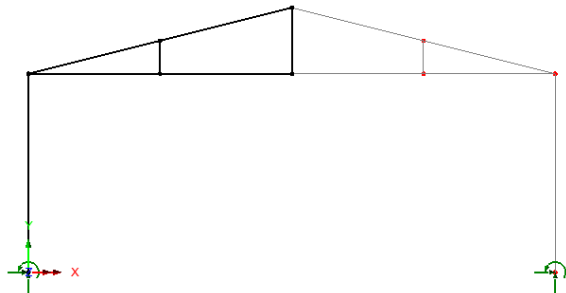



Note. In mirroring the features, the Line directions will have been reversed. The orientation of Lines is important as it controls the local beam axes directions which will define the sign convention used to present the results.

- In the Layers  Treeview double-click on **Geometry** to display the geometry layer properties. Select the **Line directions** option and click **OK**

The orientations of the lines are shown.

- Select the 4 Lines on the right-hand side of the roof that are to be reversed. (Hold down the **Shift** key to add lines to the initial selection).

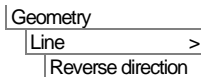
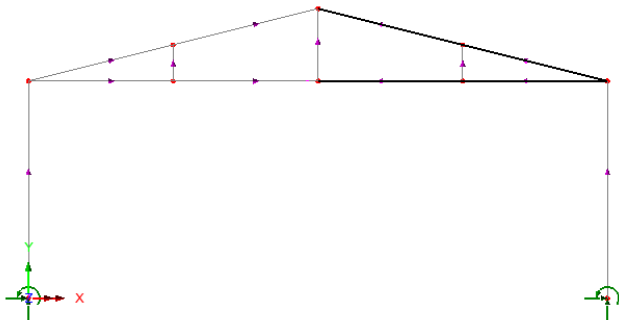

The selected Line directions will be reversed.

- Once the Line directions are corrected, de-select the **Line directions** option in the geometry layer properties and click the **OK** button.

Loading

Two loadcases will be considered; self weight, and a concentrated sway load acting at the top of the left-hand vertical member.

Loadcase 1 - Self Weight

Loadcase 1 will represent the self-weight of the structure. This is modelled using a constant body force, which is an acceleration loading simulating the force of gravity acting upon the structure.

Gravity loading is already present in the Attributes  Treeview.

- Select the whole model (**Ctrl** and **A** keys together) and drag and drop the loading attribute **Gravity vertical** from the  Treeview onto the selected features.
- Ensure that the **Assign to lines** and **Single loadcase** options are selected and the loading is applied to **Analysis 1** and **Loadcase 1**. Click the **OK** button and the loading on the frame will be displayed.

Loadcase 2 - Sway Load

Loadcase 2 is a sway load acting at the top of the left-hand vertical member.

- Ensure the **Concentrated** option is selected and click **Next**
- Enter a concentrated load in the **X** direction of **500**
- Enter the attribute name as **Sway Load** and click **Finish**
- Select the Point at the top of the left-hand column.
- Drag and drop the loading attribute **Sway Load** from the Treeview onto the selected Point.
- Ensure the **Assign to points** and **Single loadcase** options are selected, and that the selected analysis is **Analysis 1**. Change the loadcase name to **Loadcase 2** by overtyping.
- Click the **OK** button to assign the loading as the active loadcase with a factor of **1**

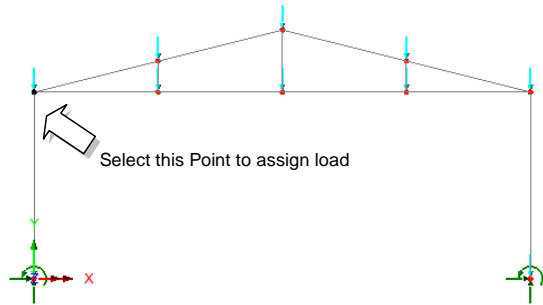

Saving the Model.

 Save the model file.

File
Save

Running the Analysis

With the model loaded:

 Open the Solve Now dialog. Ensure **Analysis 1** is selected and click the **OK** button to perform the analysis.

A LUSAS Datafile will be created from the model information. The LUSAS Solver uses this datafile to perform the analysis.

If the analysis is successful...

Analysis loadcase results are added to the  Treeview.

In addition, 2 files will be created in the Associated Model Data directory where the model file resides:



- frame_2d.out** this output file contains details of model data, assigned attributes and selected statistics of the analysis.
- frame_2d.mys** this is the LUSAS results file which is loaded automatically into the  Treeview to allow results processing to take place.

If the analysis fails...

If the analysis fails, information relating to the nature of the error encountered can be written to an output file in addition to the text output window. Any errors listed in the text output window should be corrected in LUSAS Modeller before saving the model and re-running the analysis.

Rebuilding a Model

If it proves impossible for you to correct the errors reported, a file is provided to enable you to re-create the model and run an analysis successfully. You may download this file from the user area of the LUSAS website.



- frame_2D_modelling.lvb** carries out the modelling of the example.

Creating a New Model

 Enter a file name of **frame_2d**

- Use the default **User-defined** working folder.
- Ensure an Analysis type of **2D Inplane** is set.
- Click the **OK** button.



Note. There is no need to enter any other new model details when the intention is to run a script to build an initial model, since the contents of the script will overwrite any other settings made.

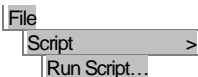



 To create the model, open the file **frame_2D_modelling.lvb** that was downloaded and placed in a folder of your choosing.

 Rerun the analysis to generate the results.

Viewing the Results

Selecting the Results to be Viewed

Analysis loadcase results are present in the  Treeview, and the last solved loadcase (Loadcase 2) is set to be active by default. This is signified by the active results bitmap .

Setting a loadcase active

- In the  Treeview right-click on **Loadcase 1** and select the **Set Active** option.

Deformed Mesh Plot

After solving, the deformed mesh is displayed to highlight any obvious errors with an analysis before progressing to more detailed results processing. The deformed shape will usually show up errors in loading or supports and may also indicate incorrect material property assignments (e.g. where the results show excessive displacements).

The deformed mesh is drawn with a blue colour.

For clarity, layers will be turned off from the display to leave only the undeformed mesh displayed.

- In the  Treeview turn off the display of the **Geometry** layer by right-clicking on the layer name and selecting the **On/Off** menu item.
- Repeat to turn off the display of the **Mesh** layer

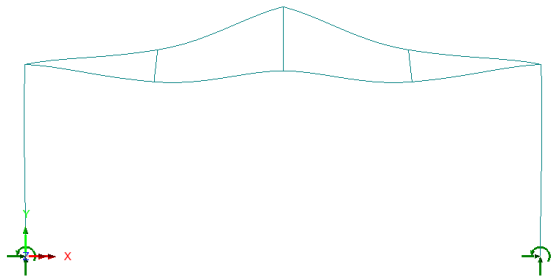

- Turn-off the display of the loading by selecting the loading on/off button 



Note. By default, the maximum displacement is scaled to the magnitude defined on the deformed mesh dialog so the deformed shape can be easily visualised. The exaggeration factor used to multiply the displacements is displayed on the deformed mesh properties dialog and can be defined if required.

Defining a Combination

Combinations can be created to view the combined effects of multiple loadcases on the structure.

Analyses

Basic Combination

The combination dialog will appear.

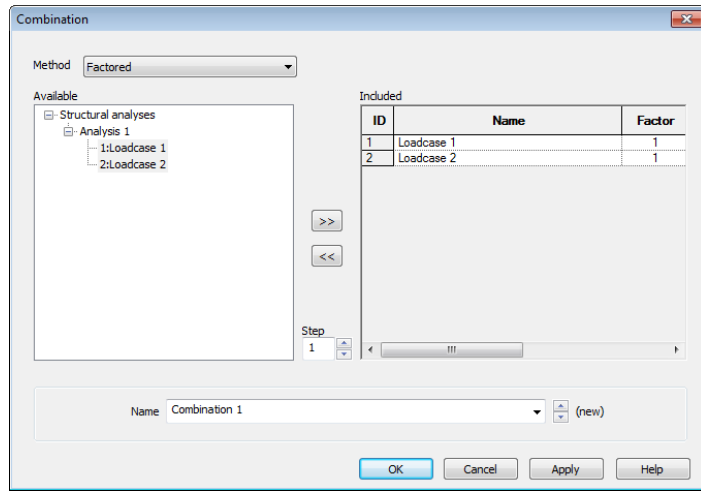

Both available results loadcases should be added to the Included combination panel.

- Select **Loadcase 1**, hold the shift key down and select **Loadcase 2**. Click the  button to add the loadcases to the load combination.
- Click the **OK** button to finish.



Note. The load factor may be modified by selecting the included loadcase in the right-hand list and updating the factor.



Note. To obtain the correct effect from the combined loads, the Combination should only include one occurrence of each loadcase.

Viewing a Combination

- In the  Treeview, in the Post Processing folder, right-click on **Combination 1** and select the **Set Active** option.

The deformed mesh plot will show the effect of the combined loading on the structure.

Marking Peak Values

- With no features selected click the right-hand mouse button in a blank part of the View window and select the **Values** option to add the values layer to the  Treeview.

The values layer properties will be displayed.

- Select **Displacement** results from the Entity drop down list and select the resultant displacement **RSLT** from the Component drop down list.
- From the **Values Display** tab set **100%** of **Maxima** values to be displayed.

- Set the number of significant figures to **4**

- Click the **OK** button to display the deformed mesh plot showing the displacement at each node.

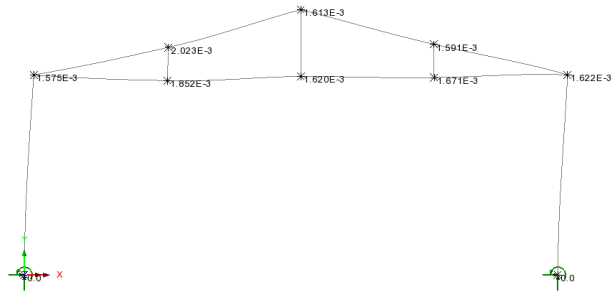

Note. This example is written for LUSAS LT, which only allows one model or results viewing window to be used, and in which all layers will have to be drawn. In Standard and Plus versions of LUSAS, multiple windows, each having different layers, can be defined. In this example the Values layer is turned off prior to adding further layers.

- Turn off the **Values** layer in the  Treeview.

Axial Force Diagram

- With no features selected click the right-hand mouse button in a blank part of the graphics window and select **Diagrams** to add the diagrams layer to the  Treeview.

The diagram properties will be displayed.

- Select **Force/Moment** results of axial force **Fx** in the members
- Select the **Diagram Display** tab and select the **Label values** checkbox.
- Ensure the number of significant figures is set to **4**
- Click the **OK** button to finish.

For results layers, the order of the layers in the  Treeview governs the order in which the layers are displayed.

- To see the deformed mesh on top of the diagram, in the  Treeview drag and drop the deformed mesh entry on top of the diagrams entry.
- To add labels to the vertical members (the stanchions), select the left hand column, hold the **Shift** key and then select the right hand column.

An axial force diagram for each member will be displayed with values of F_x displayed on the selected columns.

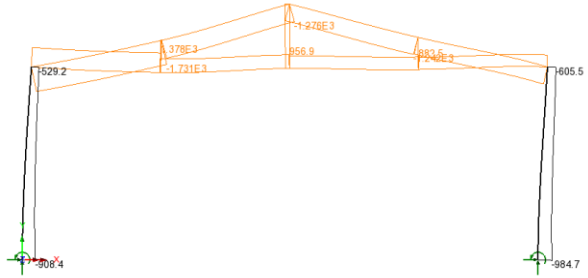

Shear Force Diagram

- In the  Treeview double-click on the **Diagrams** layer. The diagram properties will be displayed.
- Select **Force/Moment** results of shear force F_y in the members.
- Click the **OK** button to display a shear force diagram of stresses in each member with labels on the selected vertical members.

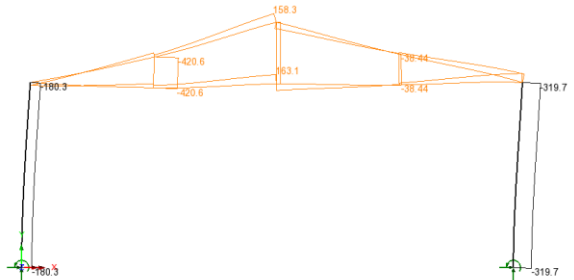

Bending Moment Diagram

- In the  Treeview double-click on the **Diagrams** layer. The diagram properties will be displayed.

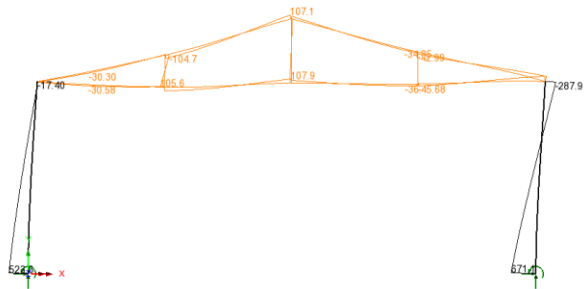

Linear Analysis of a 2D Frame

- Select **Force/Moment** results of bending moments in the members **Mz**
- Click the **OK** button to display a bending moment diagram for each member with labels on the selected vertical members.



Viewing Results on Fleshed Members

As an alternative to plotting diagram results, stresses in beams can be plotted on fleshed members.

- Turn off the display of the **Diagrams** layer in the  Treeview.
- Click in a blank part of the Graphics Window to deselect the members.
- With no features selected click the right-hand mouse button in a blank part of the view window and select **Contours** to add the contours layer to the  Treeview.

The contour properties dialog will be displayed.

- Select **Stress** results of axial and moment results in the members **Sx(Fx, Mz)** and click **OK**.
- When asked, click the **Yes** to change the settings for the Values layer to match.

Initially the contours of stress will be drawn only at the current active fibre location on both stanchions as seen on the image above. A contour key will also be drawn stating the maximum and minimum values for this fibre location. Fibre locations will be explained shortly.

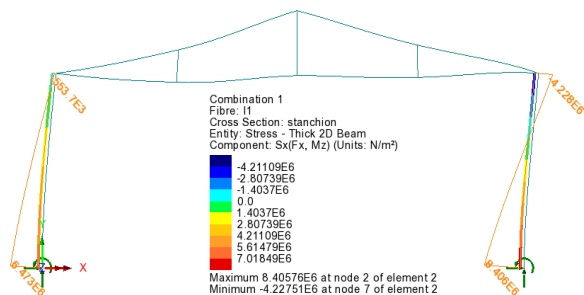

Select the isometric button.



Select the fleshing on/off button to visualise the stress results on the fleshed cross-section as seen on isometric image shown below.

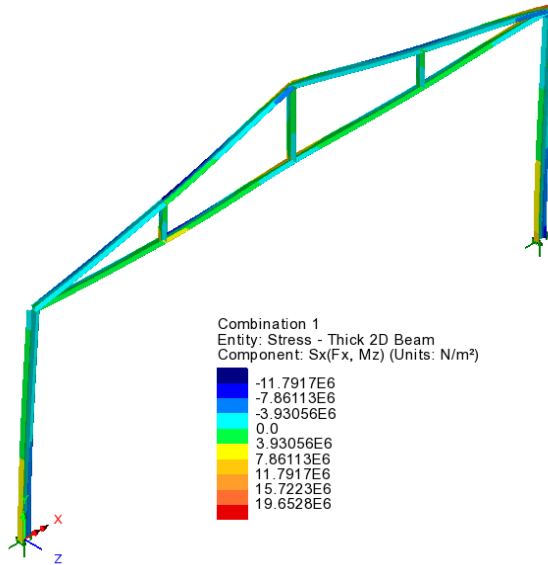

Note. When viewing results for all fleshed members, no maximum or minimum value can be shown.



Select the fleshing on/off button again to turn off the visualisation.



Select the Home button.

Fibre Locations

As an alternative to plotting force and moment diagrams along nodal lines, diagrams of stresses can be plotted at fibre locations on members.

Standard steel sections have various extreme fibre locations pre-defined. These fibre locations can be seen by expanding the Geometric Line entry in the in the  Treeview and can be visualised by double-clicking the Geometric Line attribute name and selecting the **Section details** button.

Plotting of results for a particular fibre location is done by selecting the **Set Fibre Active** context menu item as shown in the image opposite.

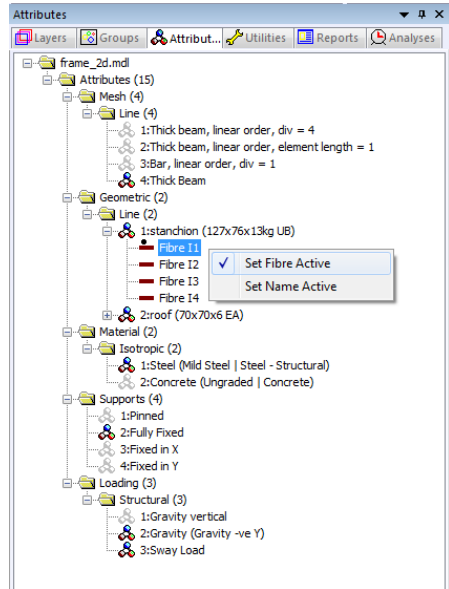
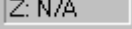

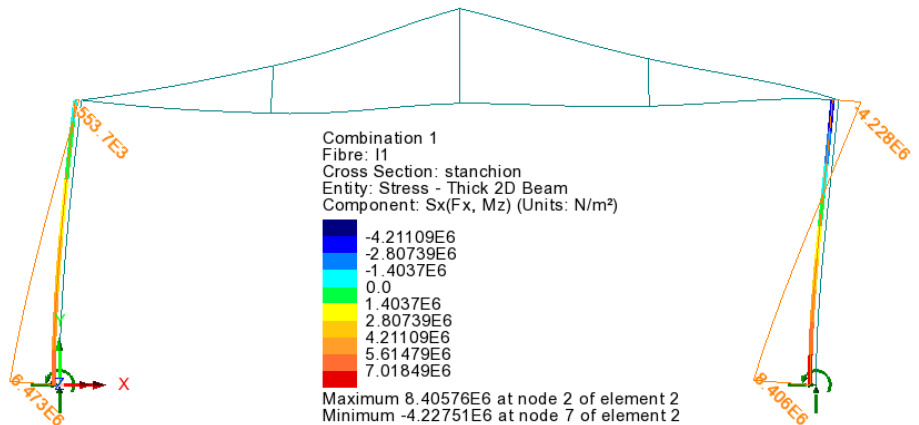

Diagram Stress Results at Fibre Locations

- Press the  button at the bottom of the interface to view the model along the z-axis.
- In the  Treeview, turn-on the display of the **Diagrams** layer.
- In the  Treeview drag and drop the **Diagrams** layer on top of the Contours layer to ensure that the diagrams are plotted on top of the contours in the view window.
- Double-click on the **Diagrams** layer and select **Stress** results of stress **Sx(Fx, Mz)** in the beam.
- Select the **Diagram Display** tab and ensure the **Label values** option is selected, and the **Label only if selected** option is deselected. Change the angle of the text to **-45** and ensure that the number of significant figures to **4**.
- Select the **Scale** tab and set a local scale of magnitude **12mm**.
- Click **OK** to display the stress diagram at Fibre location I1.



Saving views of the model

Saved views of the model can be applied to other views to easily update the layers and settings used in that view. Saved views can also be inserted into reports (such that each time a model report is generated, the saved view will be updated to show the current state of the model and results at the time of creating the report). The insertion of a saved view into a report will be shown in this example.

Window
 Save View...

- Leave the view name as **View1** and click **OK** to save the view entry into the Utilities Treeview.

Save the Model

File
 Save



Save the model file.



Note. When the model file is saved all load combinations, envelopes, saved views and graph datasets, if defined, are also saved and therefore do not have to be re-created when the model and associated results file is re-opened at a later date.

Creating a Model Report

Specified model and results details can be exported to a variety of output formats by using the LUSAS report facility. Reports can include model and results data, saved views, graphs, one-click reports, screen captures, user-content and additional text. A report template, used to specify items to be included in a report, is saved in the Reports Treeview when a model is saved. Multiple report templates are permitted.



Note. When creating a new model using startup template a predefined report entry is automatically set-up in the Reports Treeview.

Linear Analysis of a 2D Frame

This example will add a separate additional report entry to the Reports  Treeview.

On the Report dialog enter a report title of **2D Frame**

- Leave the modelling units and the number of significant figures set to default values.
- Enter a report name of **Report 1** and click **OK**.

A report entry will be created in the Reports  Treeview.

- In the Reports  Treeview right-click on **Report 1** and select **Add Chapter**
- On the Chapters dialog, with the **Model properties** tab selected select the **All** checkbox. By default this will add all model property data for All loadcases for the Full model.

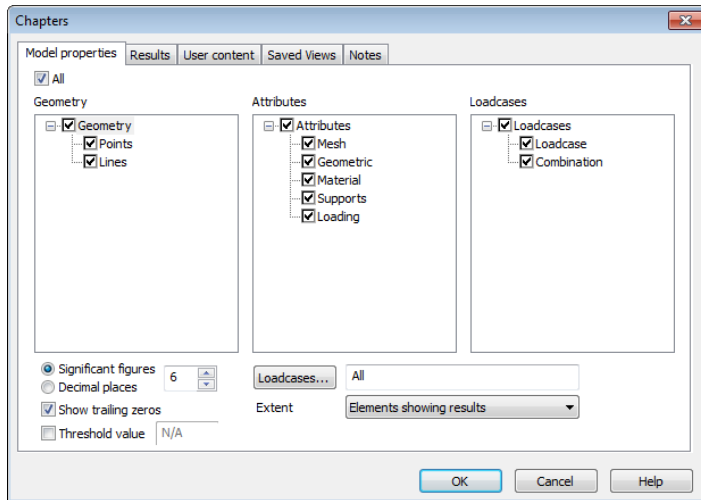

- On the Chapters dialog select the **Results** tab and click the **New** button.

Utilities >
Reporting...
New report

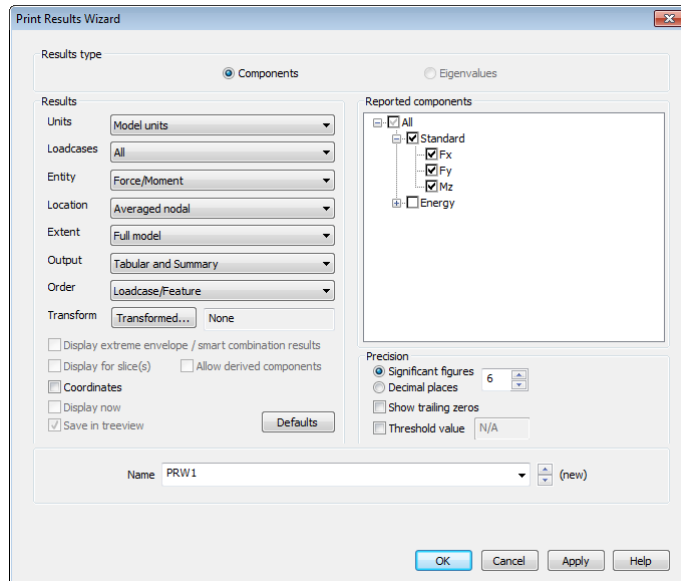

- On the now displayed Print Results Wizard dialog make the following selections:
- Loadcase: **All**
- Entity: **Force/Moment**
- Location: **Averaged nodal**
- Extent: **Full model**
- Output: **Tabular and Summary**
- Order: **Loadcase/Feature**
- Click **OK** to finish.
- Back on the report 'Chapters' dialog select the **Saved views** tab and check (tick) the **Saved view** check-box to include the contents of **View 1** in the Report. By default this will add the view contents for the Specified loadcase for the Elements showing results.
- Click **OK** to finish.

The Reports  Treeview will fill with chapters relating to the content selected.



Note. The default order of the items in the Reports  Treeview (and hence the order of any items on any exported report) can be changed by dragging and dropping the report sections as required. Right-clicking on an item gives access to additional options, such as modifying existing data or adding more chapters.

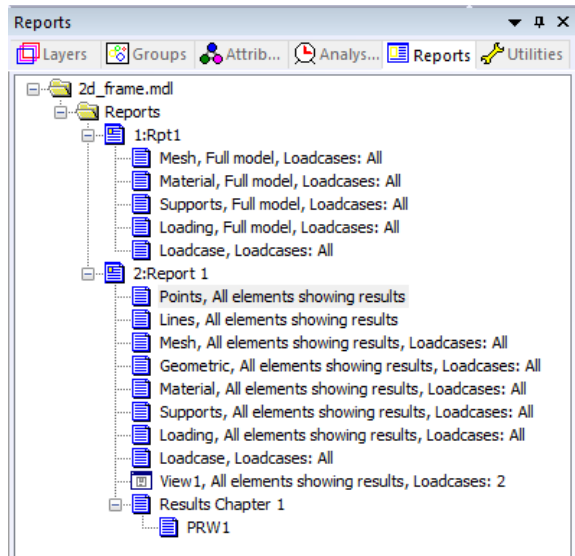

Viewing / Exporting a Report

Viewing a report automatically generates a PDF file using the report export facility.

- In the Reports  Treeview right-click on **Report 1** and select **View Report**

After a short pause whilst the requested report information is generated, a PDF file will be created and the first page of the report will be displayed.

Other export formats including Microsoft Excel (97-2003) are also available.

This completes the example.