

Buckling Analysis of a Plate Girder

For LUSAS version:	18.0
For software product(s):	Any Plus version.
With product option(s):	None.
Note: The example exceeds the limits of the LUSAS Teaching and Training Version.	

Description

The buckling behaviour of a steel plate girder with web stiffeners is to be examined.

The girder is supported at both ends by fixed and roller bearing supports. A cross-slab connection to the girder provides a partial lateral restraint. A distributed load representing transverse steel decking is applied to a selected part of the web of the girder. The steel plates are modelled using thin shell (QSL8) elements.

Units of kN, m, t, s, C are used throughout the example.

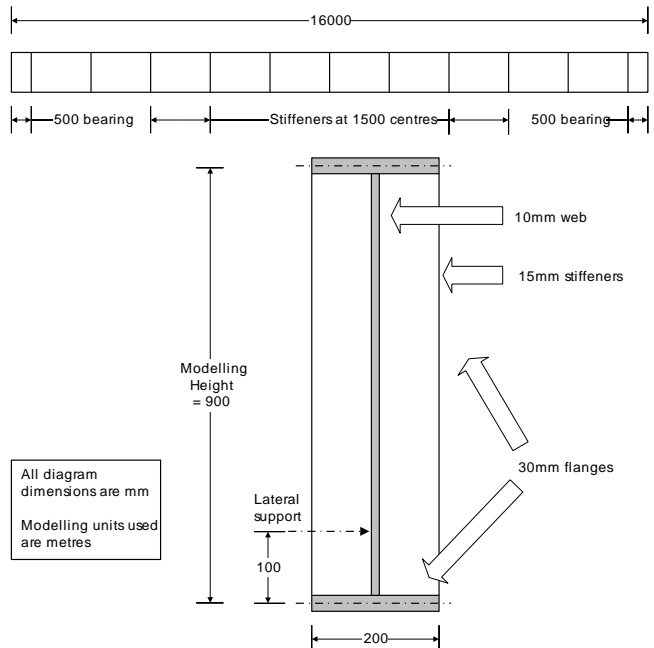

Objectives

The required output from the analysis consists of:

- A deformed shape plot showing displacements caused by the imposed loading.
- Calculation of the critical buckling load

Keywords

3D, Shell, Plate Buckling, Linear Buckling, Eigenvalue Buckling, Deformed Mesh Plot, Printing Eigenvalues.

Associated Files



- plate_girder_modelling.vbs** carries out the modelling of the example. After creating a new model and running this file, the example can be continued from the section titled *Running the Analysis*.

Modelling

Running LUSAS Modeller

For details of how to run LUSAS Modeller, see the heading *Running LUSAS Modeller* in the Examples Manual Introduction.



Note. This example is written assuming a new LUSAS Modeller session has been started. If continuing from an existing Modeller session select the menu command **File>New** to start a new model file. Modeller will prompt for any unsaved data and display the New Model dialog.

Creating the Longitudinal Beam Model

- Enter a File name of **plate_girder**
- Use the default User-defined working folder.
- Ensure an Analysis type of **Structural** is set.
- Select an Analysis Category of **3D**
- Set Model units of **kN,m,t,s,C**
- Leave the Timescale units as **Seconds**
- Select a Startup template of **3D Beam/Shell**.
- Ensure the Layout grid is set as **None**
- Enter a Title of **Buckling analysis of a plate girder**

- Click the **OK** button.

Feature Geometry

A cross-section of the girder is created initially and swept and copied into a half-model before mirroring to create the full plate girder model.

Set the Vertical Axis

Setting an analysis category of 3D sets the vertical axis to be the Z-axis. This example requires the vertical axis to be the Y-axis.

Tools
Vertical axis...

- On the Model Properties dialog set the vertical axis to be the **Y-axis**.

Geometry
Line >
By Coords...

 Enter coordinates of $(-0.1,0)$, $(0,0)$ and $(0.1,0)$ to define Lines representing the bottom flange of the girder. Click the **OK** button.

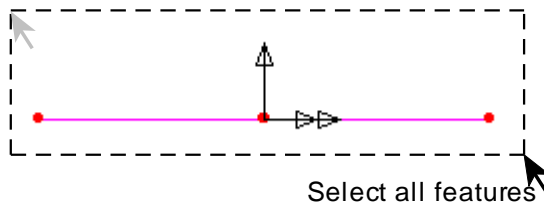

- Drag a box around all the features just drawn.

Geometry
Surface >
By Sweeping...

 Enter translation value of **0.1** in the **Y** direction to create surfaces that will define part of the end stiffener. Click the **OK** button to finish.

- Drag a box around the 2 line features shown.

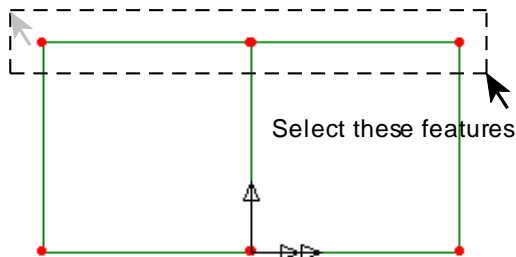

Geometry
Surface >
By Sweeping...

 Enter a translation value of **0.8** in the **Y** direction and click **OK** to create surfaces that will define part of the end stiffener.

Buckling Analysis of a Plate Girder

The girder has a 500mm long bearing region at the end which will be created first.

- Select the 6 Lines representing the cross-section of the girder as shown.

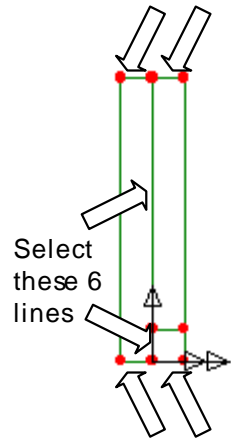

Geometry

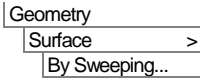

Enter a translation value of **0.5** in the **Z** direction. Click the **OK** button to finish.



Note. Save the model regularly as the example progresses. The Undo button may be used to correct any mistakes made since the last save.



Note. Holding down the **L** key while selecting ensures that only lines will be selected. Similarly the **P** key limits the selection to Points, the **S** key; Surfaces, the **V** key; Volumes and the **G** key; Geometry. Similar shortcuts exist for elements, nodes, etc., which can be found in Modeller Manual.



Use the Isometric button to view the model to a similar view to that shown

The bearing region has a stiffener either side of it.

- Select the 4 surfaces representing the 2 end stiffeners.



Enter a value of **0.5** in the **Z** direction to copy the surfaces to define the web stiffeners. Click **OK** to finish.

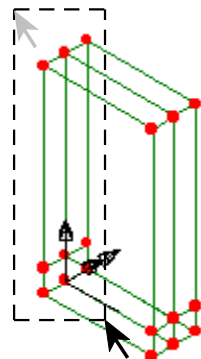
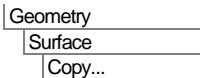

Select these 4 surfaces



Note. Many of the more common tasks are provided in the context menu. With the model geometry selected right-hand within the view to make the context menu appear. From this menu you can **Copy**, **Delete**, **Move** and **Sweep**.

The girder has 1500mm long internal panel sections along its length.

- Select the 6 Lines representing the cross-section of the girder. If necessary use the Zoom facility to simplify the selection.

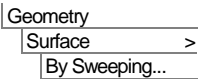
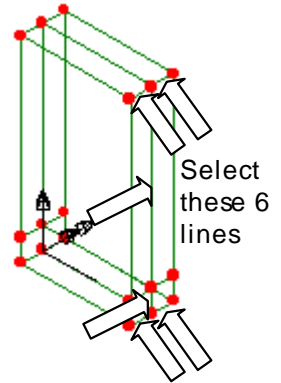

Enter a translation value of **1.5** in the **Z** direction. Click the **OK** button to finish.

- Click on the coordinate readout display panel on the Status bar to obtain a view of the model looking along X-axis.

- Hold down the **Shift** key on the keyboard and select the **X** coordinate readout panel again to obtain the reverse view looking along the X-axis.

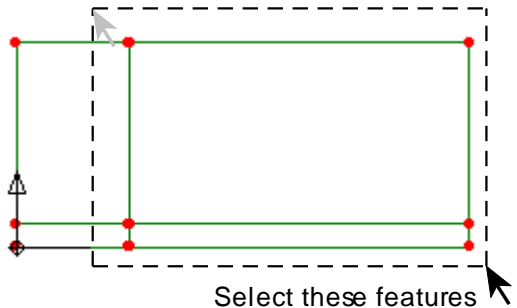

- Drag a box around all the features shown to select the first panel section and web stiffener.

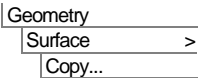

Enter a value of **1.5** in the **Z** direction.

- Enter the number of copies as **9** and click the **OK** button to copy the surfaces used to define the web and stiffener.

Finally, the other bearing end to the girder has to be created.

- Drag a box around all the features defining the left-hand bearing end of the girder and web stiffener as shown in the following image.

Buckling Analysis of a Plate Girder

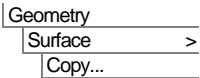
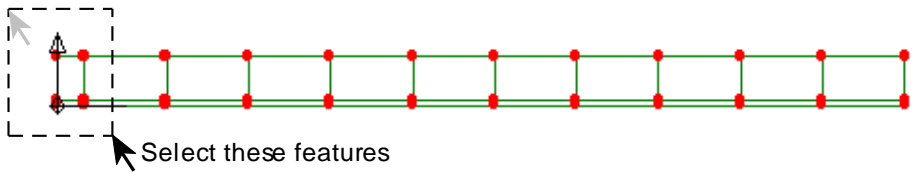

 Enter a value of **15.5** in the **Z** direction to copy the surfaces used to define the web and stiffener. Click **OK** to finish.

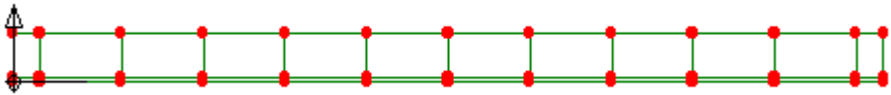

Meshing the web stiffeners

Line mesh divisions will be used to control the surface mesh density for the plates. All Lines defined so far have 4 Line mesh divisions by default. Certain Lines require different divisions to be specified.

 Select the home button to view the girder end on.

Line mesh

The Lines representing the top flange, lower flange, and part of the web and web stiffeners require 1 mesh division to be assigned to them. These could be selected individually in order to assign the line mesh division to them but LUSAS provides some advanced selection / deselection tools for this type of work.

- Hold down the **L** key on the keyboard and drag a box around the area shown to only select the Lines within the box.
- Then, with the lines still selected, hold down the **Control** key and drag separate boxes around each of the 3 points shown to deselect the lines going 'into' the screen from the initial selection.

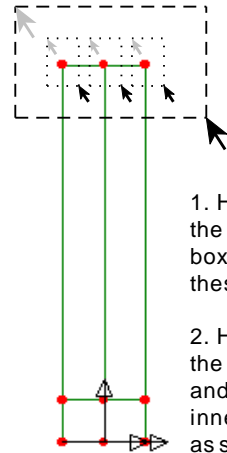

1. Hold down the L key and box select these features
2. Hold down the Control key and select the 3 inner features as shown



Note. Using the **Control** key in the manner described deselects the lines going into the screen from the previous box-selection. These lines will therefore remain meshed with 4 line divisions.



Selection of lines can be checked by using the Isometric button.

Only the lines shown in the diagram should appear highlighted to show that they have been selected.

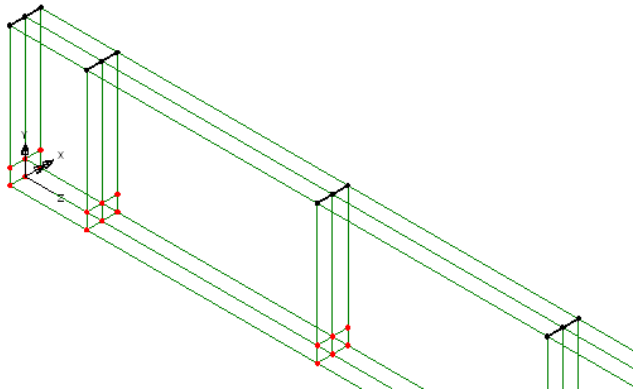

After checking, select the Home button to return the model to its initial view.

- With the lines selected drag and drop the Line mesh attribute **Null, div = 1** from the Treeview onto the selected features.

Buckling Analysis of a Plate Girder

- In a similar fashion to that done for the top flange, hold down the L key and drag a box around the area shown to select all the Lines within.
- Then, with the lines still selected, hold down the **Control** key, and drag separate boxes around each of the 6 points shown to deselect the lines going 'into' the screen from the initial selection.
- Drag and drop the Line mesh attribute **Null, div = 1** from the  Treeview onto the selected features.

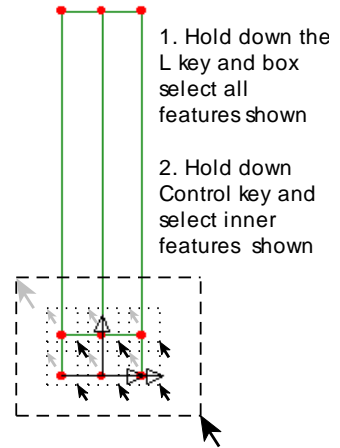

Surface mesh

- Select **Thick shell, Quadrilateral** elements with **Quadratic** interpolation.
- Enter the attribute name as **Thick shell, quadratic order** and click **OK** to finish.
- Select the whole model (**Control + A** keys)
- Drag and drop the surface mesh attribute **Thick shell, quadratic order** from the  Treeview onto the selected features.

The mesh will be drawn. Note that, by default, the mesh nodes as shown on these accompanying diagrams are not displayed.



Use the Isometric button to view the mesh on the model.



Use the Zoom in button to check the mesh definition.



Use the resize button to show the whole model



Use the Cursor button switch back to the normal cursor tool.

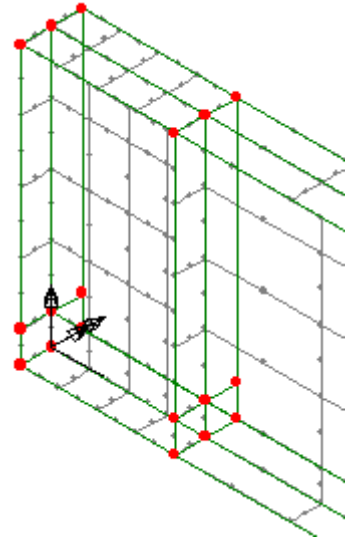

Geometric Properties

Three steel thicknesses are required to model the web, flanges and web stiffeners.

Attributes	
Geometric	>
Surface...	

- Enter a value of **0.01** for the thickness. The eccentricity can be left blank. Enter the attribute name as **Thickness=0.01m**. Click the **Apply** button to create the attribute.
- Amend the thickness to **0.015**. Change the attribute name to **Thickness=0.015m**. Click the **Apply** button to create the attribute.
- Amend the thickness to **0.03**. Change the attribute name to **Thickness=0.03m**. Click the **OK** button to finish.



Select the home button to view the beam end on.

- Select the whole model (**Control + A keys**)
- Drag and drop the geometry attribute **Thickness=0.015m** from the Treeview onto the selected features.



Select the fleshing on/off button to turn-off the geometric visualisation.

- Select the Surfaces representing the top and bottom flanges.
- Drag and drop the geometry attribute **Thickness=0.03m** from the Treeview onto the selected features.

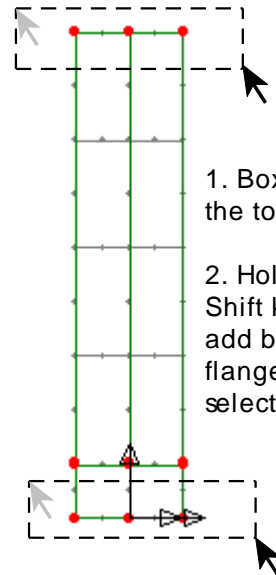

1. Box select the top flange
2. Hold down Shift key and add bottom flange to selection

- Select the Surfaces representing the web.
- Drag and drop the geometry attribute **Thickness=0.01m** from the  Treeview onto the selected features.
- Once done, click on a blank part of the graphics window to deselect the web surfaces.

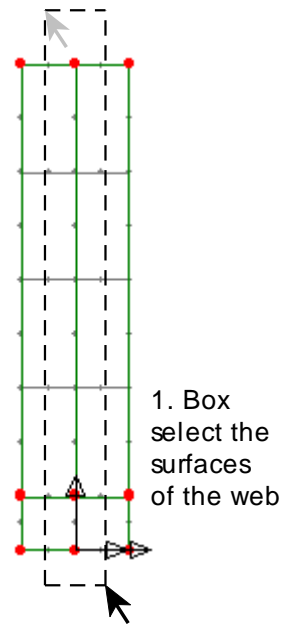



Checking attribute assignments



Note. Once assigned to the model, attributes such as geometry may be visualised.

- In the  Treeview click the right-hand mouse button on the **Geometry** layer and select **Properties**.
- On the Colour by drop-down menu select **Assignment** then select the **Set** button. Change the attribute type to show **Geometric** attributes and click **OK**. Finally, select **Solid** on the geometry properties box and click **OK**

Geometric Key
Analysis: Analysis 1
 Thickness-0.01m
 Thickness-0.015m
 Thickness-0.03m

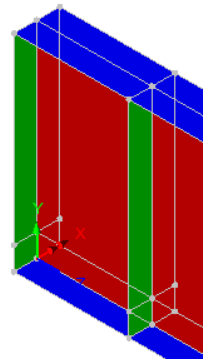

Use the Isometric button to view the model to a similar view to that shown.

- Check that the geometry assignments have been correctly assigned and then switch off the visualisation. In the  Treeview click the right-hand mouse button on the **Geometry** layer and select **Properties**.
- On the Colour by drop-down menu select **Own colour** then Finally, de-select **Solid** on the geometry properties box and click **OK**

Material Properties

The material required for this example is provided by default when using the startup template specified when creating the model.

- Right-hand click the material attribute **Steel (Mild Steel | Steel - Structural)** from the  Treeview and select **Assign to all** to apply the mild steel attribute to the whole model.

Supports

Three support conditions are required: a fixed bearing, a rolling bearing, and a lateral restraint to the flange of the girder.

Attributes

Support...

- Set the translation in the **X, Y** and **Z** directions to **Fixed**. Enter the attribute name as **Fixed Bearing**. Click the **Apply** button to reuse the dialog for the other support conditions.
- Set the translation in the **Z** direction to **Free** and leave all other translations as specified previously. Enter the attribute name as **Rolling Bearing**. Click the **Apply** button to reuse the dialog for the next support condition.
- Set the spring stiffness in the **X** direction to **10e9**. Set the translation in the **Y** and **Z** directions to **Free**. Ensure that the spring stiffness distribution is **stiffness/unit length**. Enter the attribute name as **Lateral Support**. Click the **OK** button to finish.

Buckling Analysis of a Plate Girder



Use the Zoom in button to enlarge the view of the left-hand end support.



Use the Cursor button switch back to the normal cursor tool.

- Select the 2 flange Surfaces shown. Take care to not select the lowest web surface by mistake.



Note. For features lying underneath others in the Graphics Window, continually clicking on a feature will cycle through selecting different features in turn.

- Drag and drop the support attribute **Fixed Bearing** from the  Treeview onto the selected features. Click **OK** ensuring that it is assigned to **Surfaces**.



Use the resize button to show the whole model.



Use the Zoom in button to enlarge the view of the right-hand end support.



Use the Cursor button switch back to the normal cursor tool.

- Using resize and zoom again, select the equivalent 2 lower Surfaces for the right-hand support.
- Drag and drop the support attribute **Rolling Bearing** from the  Treeview onto the selected features. Click **OK** ensuring that it is assigned to **Surfaces**.

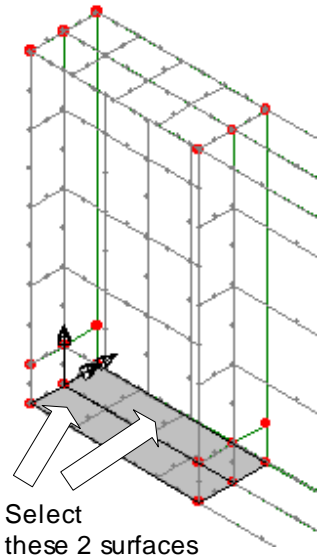



To help assign the lateral supports return the model to the default home view.

- Drag a box around the Point shown (All Lines in the same plane will be selected).
- Drag and drop the support attribute **Lateral Support** from the Treeview onto the selected features, Click **OK** ensuring that the support attribute is assigned to **Lines**.

Loading

Setting an analysis category of 3D during model start-up set the vertical axis initially to be the Z-axis and created a gravity loadcase in the the Treeview acting in the same direction. But this cannot be directly used since the vertical axis was then changed to be the Y-axis. Instead, self-weight due to gravity will be applied to the model as a property of the analysis, and this always acts in the specified vertical direction.

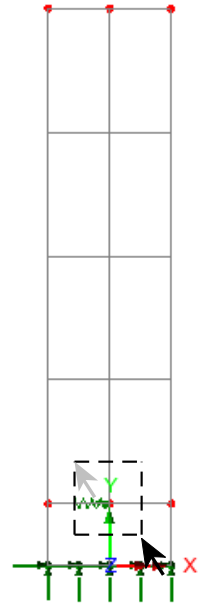

Select this Point

- In the Treeview, expand **Analysis 1** then right-click on **Loadcase 1** and select **Gravity** to apply self-weight to the model

In addition to the self-weight, a uniformly distributed load is to be applied to the flange of the beam.

- Select the **Global Distributed** option and click **Next**
- Enter a load of **-10** in the **Y** direction and specify that the load distribution be **Per Unit Area**. Enter the attribute name as **Imposed Loading** and click the **Finish** button.

Attributes

Loading...

- Select the Surfaces of the top flange as shown
- Drag and drop the loading attribute **Imposed Loading** from the  Treeview onto the selected features. Click **OK** assigning it to **Surfaces** as **Loadcase 1**
- Click in a blank area of the view window to deselect any currently selected features

This completes the modelling of the girder.

Eigenvalue Analysis Control

By default an eigenvalue analysis extracts the natural modes of vibration of a structure. It can also be used to solve buckling load analysis problems. The solution parameters for buckling analysis are specified using an eigenvalue control attribute. In this example only the 1st natural mode of buckling of the girder is to be investigated.

Eigenvalue analysis control is defined as a property of a loadcase.

- In the  Treeview right-click on **Loadcase 1** and from the **Controls** menu select **Eigenvalue**.
- Select a **Buckling Load** solution for the **Minimum** number of eigenvalues.
- Change the type of eigensolver to be used to **Subspace Jacobi**
- Enter the **Number of eigenvalues** to be calculated as **1**
- Leave the **Number of starting iteration vectors** set to **0**
- Leave the **Shift to be applied** set to **0**
- Click the **OK** button.



Note. The Subspace Jacobi solver is a robust solver and is the default solver used if the Fast Solver option is not available. Setting of values for 'Number of starting iteration vectors' and 'Shift to be applied' in order to achieve a solution for some models when the use of default values prevent one, can be done by consulting the online help or with assistance from LUSAS technical support.

Saving the model



To save the model file.

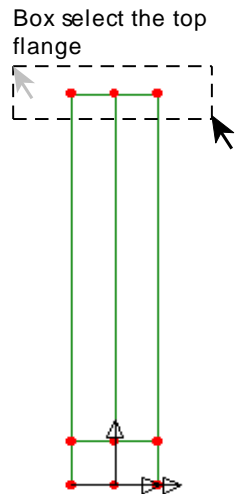

Running the Analysis

With the model loaded:



Open the **Solve Now** dialog, ensure **Analysis 1** is selected and press **OK** to run the analysis.

A LUSAS Datafile will be created from the model information. The LUSAS Solver uses this datafile to perform the analysis.

If the analysis is successful...

Analysis loadcase results are added to the Treeview.

In addition will be created in the Associated Model Data directory where the model file resides, including:



- plate_girder.out** this output file contains details of model data, assigned attributes and selected statistics of the analysis.
- plate_girder.mys** this is the LUSAS results file which is loaded automatically into the Treeview to allow results processing to take place.

If the analysis fails...

If the analysis fails, information relating to the nature of the error encountered can be written to an output file in addition to the text output window. Any errors listed in the text output window should be corrected in LUSAS Modeller before saving the model and re-running the analysis.

Rebuilding a Model

If it proves impossible to correct the errors reported, a file is provided to enable you to re-create the model from scratch and run an analysis successfully.



- plate_girder_modelling.vbs** carries out the modelling of the example.

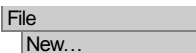

Start a new model file. If an existing model is open Modeller will prompt for unsaved data to be saved before opening the new file.

- Enter the file name as **plate_girder**

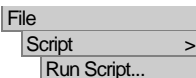

To recreate the model, select the file **plate_girder_modelling.vbs** which is located in the **\<LUSAS Installation Folder>\Examples\Modeller** directory.



Rerun the analysis to generate the results.

Viewing the Results

Analysis loadcase results are present in the Treeview.



Select an isometric view of the model.

- Turn off the display of the **Attributes**, **Geometry** and **Mesh** layers in the Treeview.
- Right-click in the View window and select **Deselect All** to remove any unwanted previous selections made.

Deformed Mesh Plot

- Turn on, and then double-click the **Deformed mesh** layer to the Treeview.
- From the Deformations tab, select **Specify factor** and enter a factor of **2**
- Click the **OK** button to display the first eigenmode shape.

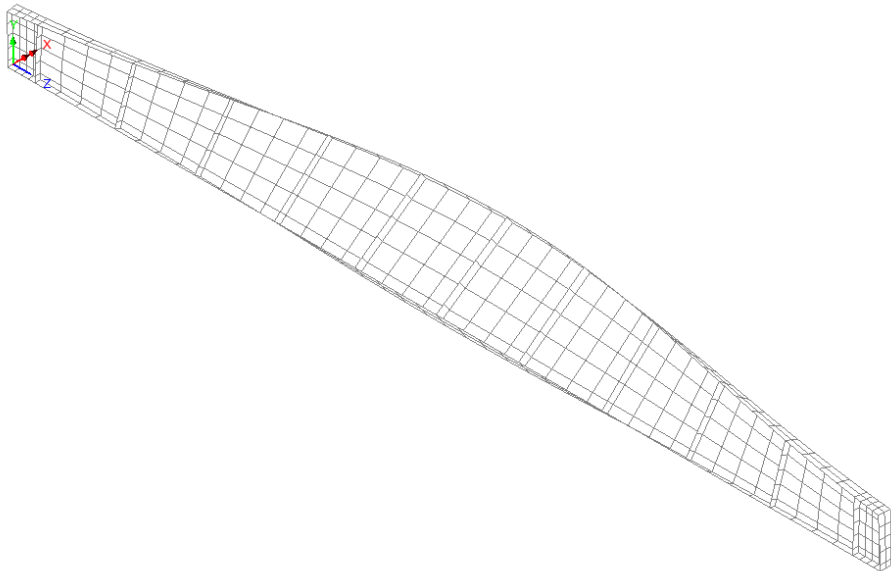

Printing the Buckling Load Factors

In an eigenvalue buckling analysis, the load factors are equivalent to the eigenvalues. Load factors are the values by which the applied load is factored to cause buckling in the respective modes. Eigenvalue results for the whole model can be displayed in the text window.

Utilities

Print Results
Wizard...

- Select results type **Eigenvalues**.
- In the Results panel, and for Loadcase 1, ensure that **Eigenvalues (Load factor)** is selected and click the **Finish** button.

The Eigenvalue result will be displayed and a Print Results Wizard entry (PRW1) will be added to the Utilities treeview

Eigenvalue, Load factor and error norm will be listed. Error norms may vary.

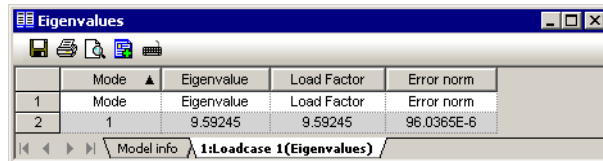

	Mode ▲	Eigenvalue	Load Factor	Error norm
1	Mode	Eigenvalue	Load Factor	Error norm
2	1	9.59245	9.59245	96.0365E-6

Model info 1: Loadcase 1 (Eigenvalues)

Calculating the Critical Buckling Load

The applied distributed load of -10kNm^{-2} and the gravity load must be multiplied by the first load factor (9.59245) to give the value of loading which has been calculated as causing buckling in the first mode shape.



Note. An applied load of unity could be used in an eigenvalue analysis - in which case the eigenvalues produced would also represent the critical loads at which the structure would buckle. However, to prevent potential convergence problems with the analysis it is more usual to apply actual in-service loading and multiply the applied load by the eigenvalue to give the critical buckling load for each eigenvalue.

This completes the example.

Notes Relating to Buckling Analysis

This example has taken you through the process of carrying out a linear buckling analysis on a plate girder. Linear buckling analysis is a technique that can be used to estimate the load that can be supported by a structure prior to structural instability or collapse. However a number of points should be considered when carrying out this type of analysis:

- Buckling analysis is dependent on applied loading. Load factors appropriate to the analysis should be included when the loads are assigned.
- For this example gravity and imposed loading were assigned to the same loadcase (Loadcase 1), to which an eigenvalue analysis control was also defined. For some situations it may be required to assign gravity to a separate loadcase (Loadcase 1) from any imposed loading (Loadcase 2), to which an eigenvalue control would also be specified.
- Buckling analysis is dependent on the initial model geometry being considered. A perfectly straight (and undeformed) model will provide different answers from a model with imperfect geometry. See *Generating a model with imperfect geometry* below.
- An eigenvalue buckling analysis actually requires the use of elements with geometrically nonlinear capabilities in order to create additional stress terms in the stiffness matrix. Some elements do not have a nonlinear capability. Refer to the Element Reference Manual before such an analysis is commenced.
- The eigenvalue buckling analysis of the structure can only be used to provide the mode shape of the structure and the critical buckling load. The stresses and displacements that are obtained are relative to the unit normalised eigenvector and are generally of no practical use. To obtain member forces for the girder it is necessary to perform a further linear static analysis with the same combination of loading on the structure. The stresses and displacements in the structure when the critical load is applied may be obtained simply by performing a linear static analysis with the loads factored to the buckling load previously derived. These may be compared to other limit state criterion to determine the load carrying capacity of the structure. The critical buckling stress for the mode under consideration will be obtained from the same analysis. If required this can then be used with reference to design codes to calculate the value of the slenderness parameter for lateral torsional buckling λ_{LT} and the limiting compressive stress σ_c .
- This analysis type will provide both local and global buckling modes. However, engineering judgement is necessary to determine which buckling mode is critical in order to select the appropriate buckling load factor.

- If a load factor very close to unity is derived, it would normally be prudent to carry out further investigation, removing some of the assumptions in the initial analysis and perhaps carrying out a nonlinear analysis.

Generating a model with imperfect geometry

If required, an imperfection can be built into the initial model either by manually defining the appropriate geometry or by using the deformed mesh from one analysis (or load increment / time step / eigenvalue) as the starting point for a further analysis.

To do this:

- Turn on the display of the **Attributes**, **Geometry** and **Mesh** layers in the  Treeview.
- Setup a new analysis by selecting the **Analyses > Generate Structural Analysis** menu item.
- On the Analysis dialog, with the General tab active, ensure that **Inherit from base analysis** is specified to use properties defined for the first 'base' analysis.
- Select the Initial deformations tab and choose the option to **Start with deformed mesh** from **Analysis 1** and **Loadcase 1**
- Enter a suitable scale factor for the load increment / time step / eigenvalue of interest, and click OK to save the settings made.
- Modify existing loading, supports, or assign any new material properties (if a nonlinear analysis were to be carried out) as necessary and solve the model.

