

Vehicle Load Optimisation of a Box Beam Bridge

For LUSAS version:	21.1
For software product(s):	Bridge and Bridge Plus
With product option(s):	LUSAS Vehicle Load Optimisation

Description

A 5-span concrete box curved bridge with end spans of 45m and three internal spans of 50m is modelled with beams to illustrate the use of the Direct Method Influence (DMI) attributes and Vehicle Load Optimization (VLO) facilities in LUSAS.

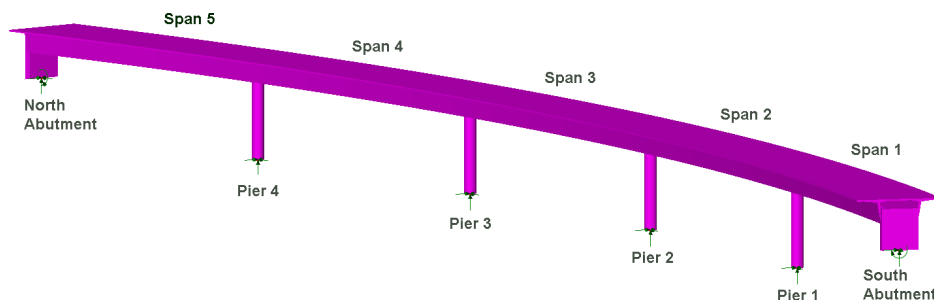

A pre-defined base model with assigned mesh, material and support attributes is supplied for use with this example.

Units used are kN, m, kg, s, C throughout.

Objectives

The required steps in the analysis consist of:

- Run a Direct Influence Method Analysis to calculate the effects of a unit load
- Define influence attributes and assign them onto the model
- Create influence surfaces
- Create optimised vehicle loading results with VLO

Keywords

3D, Beam, Bridge, Concrete, Box Girder, Direct Method Influence, Vehicle Load Optimisation

Associated Files

Associated files can be downloaded from the user area of the LUSAS website.



- curved_bridge.lvb** creates an initial basic beam model of the bridge.

Modelling



Note. Model and results images included in this example were captured in an earlier version and may differ in appearance from those seen and obtained from this version.

Running LUSAS Modeller

For details of how to run LUSAS Modeller, see the heading *Running LUSAS Modeller* in the Examples Manual Introduction.

Creating a Model

- Enter a file name of **curved_bridge**.
- Use the default **User-defined** working folder.
- Ensure an Analysis type of **3D** is set.
- Click the **OK** button.



Note. There is no need to enter any other new model details when the intention is to run a script to build an initial model, since the contents of the script will overwrite any other settings made.

-  To create the model, open the read-only file **curved_bridge.lvb** that was downloaded and placed in a folder of your choosing.

File
New...

File
Script >
Run Script...

Model Description

The 5-span, box girder bridge has spans of 45m, 50m, 50m, 50m and 45m, all set-out to a horizontal curvature of 510m radius. For simplicity the cross section of the bridge is considered constant across its length, and the deck is supported on 5.5m high abutments and 12.5m high circular pier columns, which are considered fully integral with it. The box girder of the deck, including cantilever outstands, is 11.5 m wide. The carriageway itself is 7.7m wide, with space for a footway on the inside and hard standing margin on the outside.

The deck is modelled as a series of beams along the centreline of the carriageway at a radius of 510m. The kerb lines defining the extent of the loadable carriageway are defined at the deck level, above the nodal line, using lines of 506.55m radius and 514.25m radius – a difference of 7.7m, which relates to the width of the carriageway.

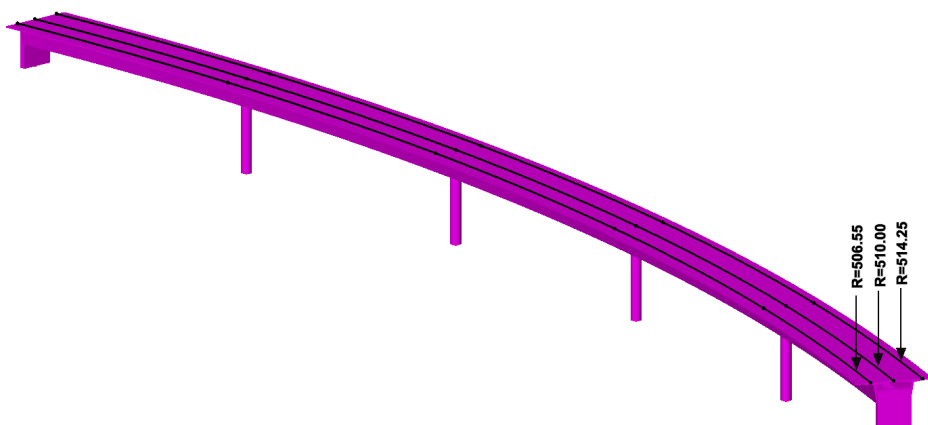



For the purposes of this example the geometric lines of this model have been assigned a line mesh of thick beam elements with a specified element length of 5m. A cylindrical coordinate system has been used to orientate the abutments and piers supports. Concrete EU $f_{ck}=50\text{MPa}$ has been assigned to all members. Pin supports restrain the base of the piers and other pin supports, having the additional fixity, THY, are used at the abutments. A local cylindrical coordinate system has been assigned to the end points to orientate the supports as needed.

The Direct Method Influence method is to be used for vehicle load optimisation analysis instead of the Reciprocal Theorem because it allows the structure to be analysed as a simple line-beam model.

Defining a reference path

A reference path is to be created for use as a centreline for the bridge and also to define a grid which will be used for the loading locations required to create influence shapes in Direct Method Influence Analysis. The use of a reference path is recommended for most vehicle loading and load optimisation situations.

- In the  Treeview right-click on **Deck** and click **Select Members** to select the lines representing the bridge centreline.
- Change the name to be **Bridge Centreline** and click **OK**. A corresponding path definition entry will be created in the  Treeview.

Utilities
Reference Path...



Note. The direction of the reference path will control the order of any created influence entries in the  Treeview.

Defining a search area

A search area is to be used to limit the area or features over which loads are applied, so that the effect of the load on certain features may be removed from the analysis. It is strongly recommended to define a search area for VLO analyses.

- Change the name to **Deck** and click **OK**.
- In the  Treeview, and with the lines defining the deck still selected, drag and drop the newly defined **Deck** search area on to the model to assign the attribute.

Attributes
Search Area...

Direct Method influence analysis

Direct Method influence analysis is a means of creating an influence where the effect of a specified point load is assessed at each node or grid location on a loadable area of a structure. The value of the load effect of interest at each specified location is then used to construct an influence line or surface for that location. The direct method influence enables the construction of influence surfaces for any results component at any node in the structure.

Direct Method influence analysis can be carried out either by defining and assigning influence attributes to the model before carrying out an influence analysis (as has to be done for the Reciprocal Theorum Method), or by pre-solving for the nodes in a search area, or for the points on a loading grid, (without having any influence attributes assigned to the model) to evaluate the effect of a unit load at the beginning. This optional approach caches the results for each node or loading point on the grid so that they are available when an influence attribute is assigned to the model at a later stage, allowing influence shapes to be generated for chosen locations at any time. Note that for a line beam analysis, as used in this worked example, Direct Method influence attributes must be used.

Defining a Direct Method influence analysis

Analyses

Direct Method

Influence Analysis

General...

- Choose **Deck** as the **Search area** in order to apply a prescribed unit load only on the deck beams.

For a line beam model, where the geometric section represents a beam with a loadable top slab, a loading grid of points should be defined to represent the slab. This virtual grid is equivalent to the nodes or points present in a shell or plate model and is used to create an influence surface for each location of interest.

- Ensure that **Grid** is selected.
- Ensure that the chosen Centreline is the previously defined **Bridge Centreline** reference path.
- Set a Transverse width of **11.5**. This is the width of the grid to be loaded for influence analysis.
- Press the **Grid Settings** button and make sure that **Match nodes in search area (line beams only)** is selected. Click **OK** to return to the previous dialog.
- Change the name to **DMI My** and click **OK** to exit the dialog.



Note. The Grid Settings advanced dialog controls the spacing and number of load locations within the defined width and search area length. For line beam models the most accurate results are obtained when the grid spacing along the centreline of the loading grid is set to match the longitudinal spacing (and hence number of nodes) of the underlying beam mesh.



Note. When the ‘Match nodes in search area option’ is used for line beams models, only 1 transverse point is used to define the extent of the loading grid to each side of the line beam. Using a larger number of transverse points across a single beam will not make the analysis more accurate and is not required because results are only calculated for the two extreme fibres. If a very fine grid was defined the solution stage may take some time, as the solution time is proportional to the mesh and grid density.

The defined grid that is now shown on the model will be used by an influence analysis to apply a unit load at each grid point.

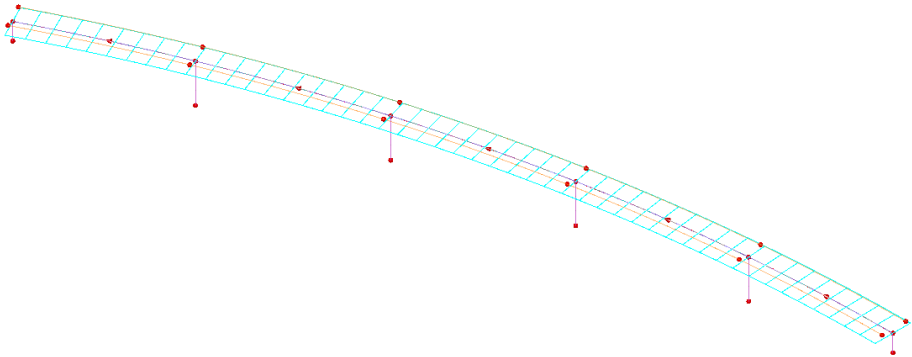

The grid can be displayed or hidden on the screen.

- In the  Treeview right-click on **DMI My** and select **Show Grid** to un-tick the entry and make the grid invisible.



Note. A Direct Method Influence analysis can include any number of influence types or can include only particular influence assignments for a particular span or section of the model. Here, an analysis for just one influence type (My) is being used for all spans.

Solving for a Unit loadcase

- Press the **Solve Now**  button. On the Solve Now dialog ensure that both **Analysis 1** (which includes the self-weight loadcase that assumes the bridge is wished-in-place for the purposes of this example) and also **DMI My** are checked and press **OK** to run the analysis.

This applies a unit load to each loading point on the grid and caches the results for each point so that they are available when an influence shape is required to be generated.

If the analysis is successful...

A results loadcase for Analysis 1 and a DMI My analysis entry are added to the  Treeview.

Defining Direct Method influence attributes

Now that the influence analysis has been solved the definition of influence attributes can be done prior to assigning to nodes in the structure.

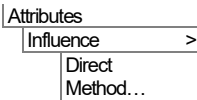

- Select Entity as **Force/Moment**
- Ensure the Direction is **Local**
- Select **My** as the Component of interest.
- Enter **My Influence** as the name and press **OK** to close the dialog.

Once created, an influence attribute is held in the Treeview for assignment to selected nodes or points. Note that subsequent assignment of the same attribute to other nodes or points of interest on a model will use the same influence type settings that were initially made.

Assigning Direct Method influence attributes to the deck

Influence assignments will be made to all nodes along lines representing the deck.

- In the Treeview turn off the display of the **Utilities** layer This turns-off the display of the reference path.
- In the Treeview right-click on **Deck** and click **Set as Only Visible** to display only the lines representing the bridge centreline.
- **Hold-down the N key** (to select just the Nodes) and make a box-selection with the cursor to enclose the five lines representing the deck. 49 nodes will be selected.
- From the Treeview, drag and drop the **My Influence** attribute onto the selection in the view window to assign it to the selected nodes.

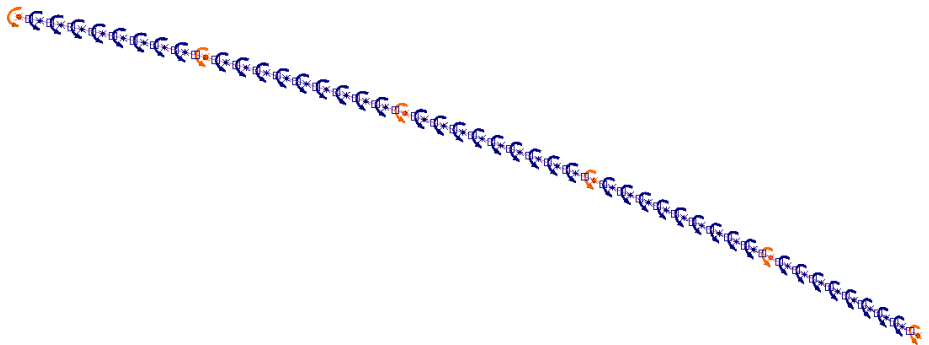

Influence loadcases (as yet unsolved) will be added to the **DMI My** analysis in the Treeview, indicating the name and position of the influence attribute assigned. Note that where a node coincides with its parent geometry the geometry name will appear as part of the influence assignment name.

- With no features selected right-click the view window and select **All visible**.

Finding assigned influence locations

In models with lots of elements, nodes and attributes you can quickly locate an assigned influence location in the view window by selecting this context menu item for an influence attribute:

- In the  Treeview, right-click on **My Influence (My) – (495.947, 118.896, 0.0)** and choose **Find**.

A temporary indicator will appear, highlighting the node with the assigned influence attribute, and showing it to be in the middle of span 3.

Visualising influence shapes

- In the  Treeview, right-click **My Influence (My) – (495.947, 118.696, 0.0)** and now choose **Set Active** to view the influence shape for My at the centre of span 3. Click **Yes** to Solve and open the results, if asked.

Note that the results loadcase must be set active, and the next step must be completed before the influence shape will be drawn.

- With no features selected right-click in a blank part of the view window and select the **Influence shape** option.
- In the  Treeview turn the **Geometry** off, to leave a view of the chosen influence shape.

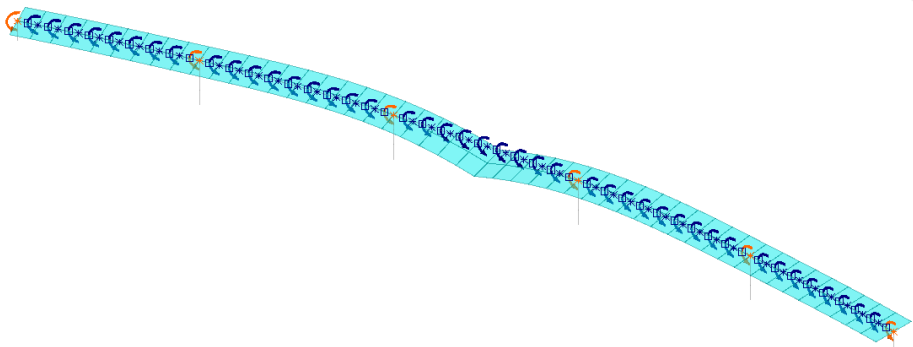

Contouring influence results

After the influence attributes have been defined and assigned, contours can be added to the view to indicate just what effect the degree and direction of influence loading applied along the surface will have on the assigned node.

- With no features selected right-click in a blank part of the Graphics window and select the **Contours** option to add the Contours layer to the  Treeview.
- Select the Entity **Influence result**. Note that the Component **Inf** and Display of **Nodal** will be automatically selected.
- To plot the contour on the influence shape, select the **Contour Display** tab, click the **Appearance** tab, and tick **Deform**.
- Press **OK** to exit the dialog.

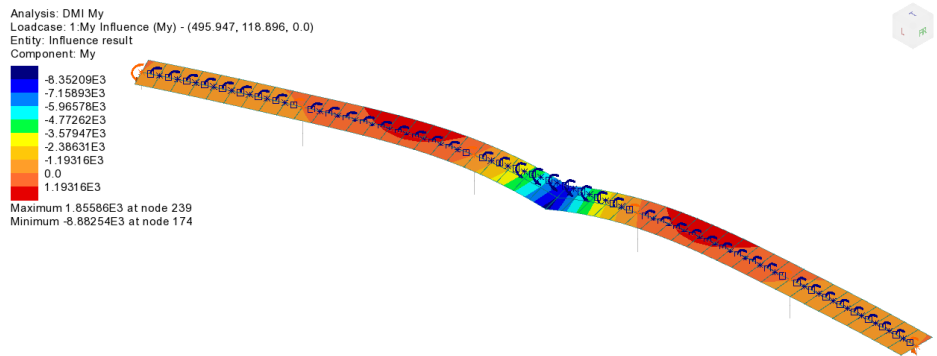

The contours can be simplified to indicate which areas of the structure, when loaded, will have a positive, or negative influence for the selected influence assignment.

- Double-click the **Contours** layer to the  Treeview to open the properties dialog.
- Select the **Appearance** tab, press the radio button for the **Red/Blue** option, and click **OK**.

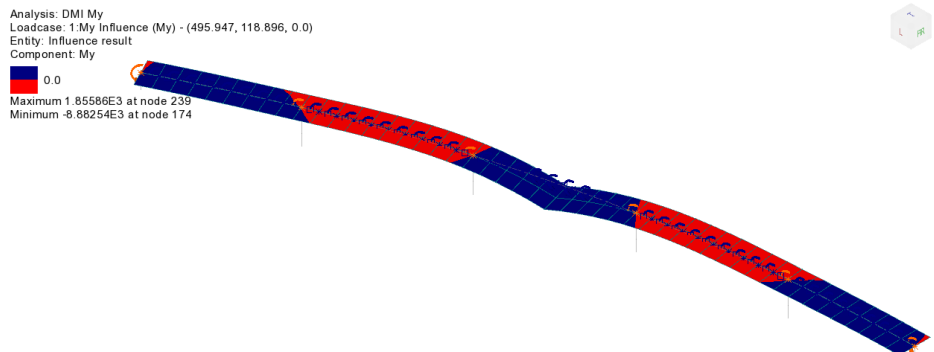



Note. For this influence analysis, carried out using Direct Method Influence attributes, vehicle loading placed onto the negative areas (blue) will create a negative

moment for the influence shape for this chosen influence location. Vehicle loading placed onto the positive areas (red) will create a positive moment for the influence shape for this chosen influence location. The Vehicle Load Optimisation facility will make use of these areas in its positioning of traffic loading patterns.

Vehicle Load Optimisation (VLO)

Now that influence attributes have been defined and assigned, the VLO facility can be used to define optimised traffic loading for the bridge for these influence assignments, based on a chosen code of practice. In this example EN1991-2 UK will be used. Note that unlike Reciprocal Theorem influence attributes, Direct Method influence attributes can be assigned to the whole model regardless of whether nodes lie in a positive or negative region of an influence shape.

- In the  Treeview, turn off **Contours** and **Influence shape** and **Annotation**
- In the  Treeview, turn on **Geometry**
- In the  Treeview, turn off the Visualisation of the **My Influence (My)**

Selecting kerb lines



Note. In this model, the lines defining the extent of the loadable carriageway have been defined as Combined Lines which cannot be directly used by the VLO facility. But, and as a general rule, any lines representing kerbs should always be saved as a Group to aid easy selection. This has been done for this example and the points and lines representing the kerbs can then be selected indirectly by selecting the Group in which they are members.

- In the Groups  Treeview, right-click on the **Kerblines** group, and then select **Select Members** to select the lines representing the extent of the carriageway.
- Select **United Kingdom** from the Country drop list and choose **EN1991-2 UK 2009** as the Design code.

For simplicity only the effects of a characteristic LM1 load will be considered in this example.



- Press **Optional Code settings** and ensure that **Characteristic** is the only one of the representative values required, and **Group 1a – LM1** is the only one of the load groups to be included. Press **OK** to exit the dialog.
- On the main VLO dialog, press **Define carriageways**. Ensure **Kerbs from selection** is selected and press **Apply** to exit the dialog.
- On the main VLO dialog, press **Set influence surfaces** and on the next dialog select **Include all influence surfaces**.

- Ensure that the **Positive** and **Negative** checkboxes are selected for all the My Influences included (see note below). This means that the VLO analysis will produce loading patterns for positive and negative effects of My.



Note. Clicking in the header cell of a column will select the whole column so that checking (ticking) one entry will check (tick) all in that column.

- Press **OK** to return to the main VLO dialog.
- Ensure the option to **View onerous effect table** is selected.
- Ensure the option to **Create loading patterns** is not selected.
- To specify a non-default analysis name, choose **New** from the drop-down list, and enter the analysis name to be **VLO DMI My**
- Change the VLO run Name to be **LM1 All**
- Press **OK** to exit the dialog and generate optimised loading.

After a short time, and at the bottom of the  Treeview, the new **VLO DMI My** analysis will be created. This contains the **LM1 All** VLO run, as denoted by this icon , which includes Characteristic results table entries for the negative and positive My Influence assignments as shown in the following image.

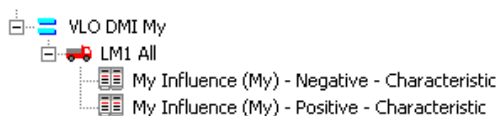

VLO results tables will also appear on tabbed results pages for the negative and positive influence assignments that have been made, and with the most onerous influence assignment in each set of tabbed results shown highlighted in red.



Note. Because the option to ‘Create loading patterns’ was not chosen on the main VLO dialog, no loading folders will initially appear for an influence in the  Treeview, but the VLO results table will show ‘Create Loading’ alongside all influence assignment entries, loading patterns to be created, as necessary, one at a time.

- First, in the  Treeview right-click on **Kerblines** and click **Invisible** to hide the lines representing the kerbs.

Filtering influence results

- In the VLO results table, ensure that the **My Influence (My) – Negative – Characteristic** tab is selected.

Vehicle Load Optimisation of a Box Beam Bridge

By default, results in tables are listed for all visible nodes in order of descending effect showing the most onerous value at the top of the listing in red. If desired, and by selecting a feature on the model, only those results applicable for a particular feature may be shown. One way of seeing this is to arrange the View and Results Table windows side-by-side and to select the individual lines representing each span of the model in turn as follows:

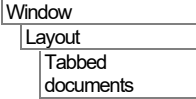

If necessary, ensure that tabbed documents are being viewed.

- Click, hold-down and drag the tab named **LM1 All My Influence...** towards the bottom of the view window until a highlighted region, that represents the new position of the view window, appears, and then release.

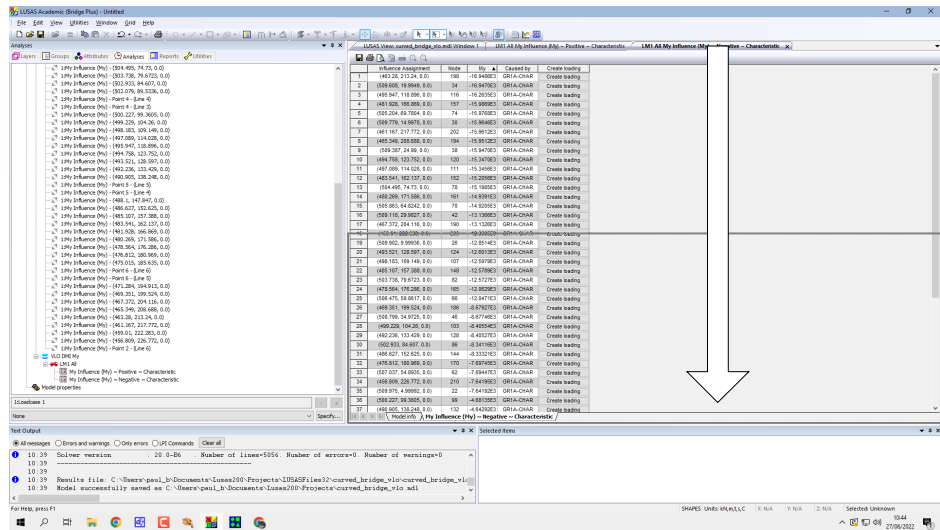

- Then click on the tab 'curved_bridge' to position the model view above the results table, as shown in the following image.

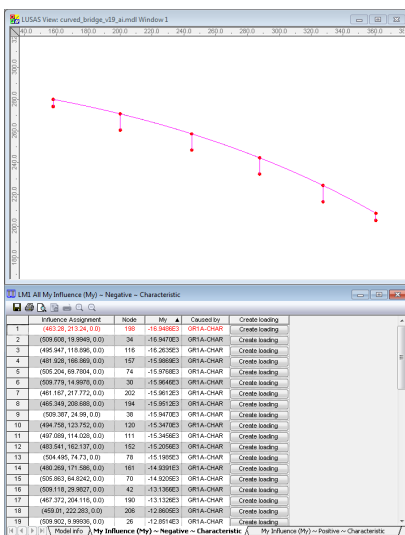

Unfiltered influence results show results for all features (all spans)

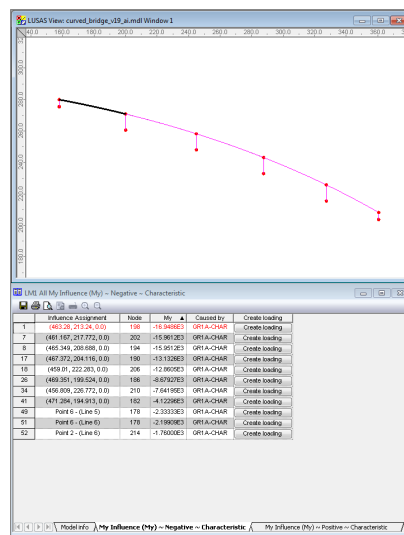

Influence results filtered to show only those results for a selected feature (span 5)

- In the model view window, select each of the lines representing the spans in turn to filter the results in the table and see that the most onerous effect (denoted by the red text) occurs in span 5.

Creating loading patterns

For this worked example, the most onerous loading effect for the influence assignment of interest will be created individually by pressing the ‘Create Loading’ button alongside the appropriate entry in the onerous results table.

With the line representing span 5 still selected:

- In the VLO results table ensure that the **My Influence (My) – Negative – Characteristic** tab is selected and press the **Create loading** button for the most onerous negative result entry (shown in red at the top of the table in the preceding images).

A loadcase entry and a Loading folder will appear for the VLO results table entry in the Analyses Treeview for that influence. When expanded, it will appear as shown in the following image.

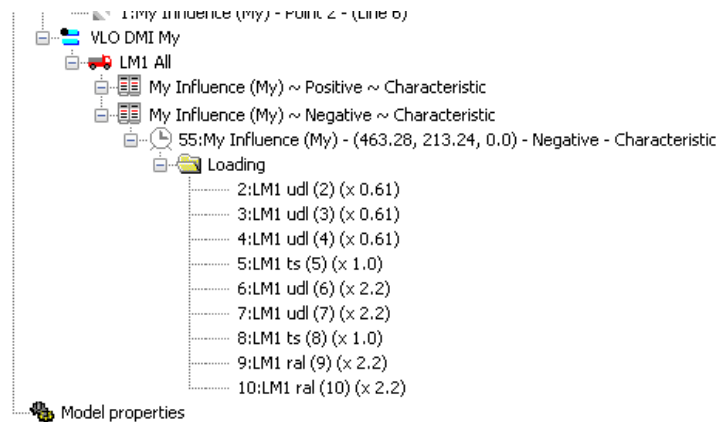



- Leave the results table open to create additional loading patterns.

Check the loading visualisation settings

Before visualising the loading, it is prudent to check or correct the settings required.

- Click in the Model view window to make that view active (instead of the table of results view) and if necessary, use the dynamic zoom to enlarge the model.
- In the  Treeview double-click **Attributes**
- Select the **Loading** tab and press **Settings...** button.
- Ensure **Show discrete loading by definition** is selected and press **OK** to exit the dialog.
- Press **OK** to return to the model.

Negative effects

- In the  Treeview, and from within the VLO DMI My, LM1 All section, select the **My Influence (My) – (463.28, 213.24, 0.0) – Negative - Characteristic** loadcase and choose **Set Active**.
- Press  to visualise loading.

The optimised loading for the characteristic case of EN1991-2 UK that gives the maximum My effect in the mid-span of span 5 for negative influence will be displayed.

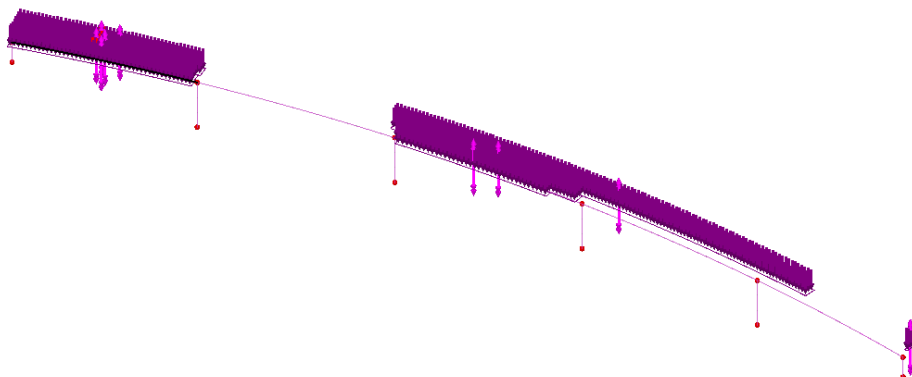

Positive effects

With the line representing span 5 still selected:

- Go back to the VLO results table and select the **My Influence (My) – Positive – Characteristic** tab and press the **Create loading** button for the most onerous positive result entry for the line selected. Note that this entry is not the most onerous value for the bridge as a whole because it is not shown in red.

A loadcase entry and a Loading folder will appear for the VLO results table entry in the  Treeview for that influence.

- In the  Treeview, and from within the VLO DMI My section, select the **My Influence (My) – Point 6 - (Line 6) – Positive - Characteristic** and choose **Set Active**.

The optimised loading for the characteristic case of EN1991-2 UK that gives the maximum My effect positive influence for the selected span will be displayed.

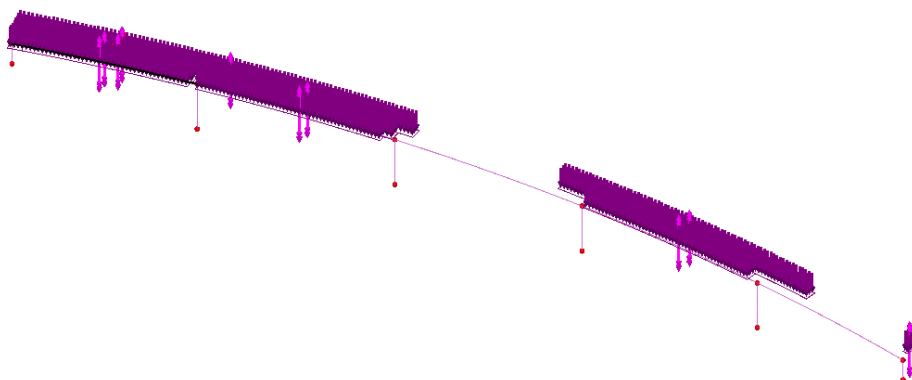

After further inspection (by selecting the line of each span and looking at the filtered results in the onerous results table) it can be seen that the most onerous results for hogging are actually obtained for span 3 at pier 2 (Point 4).

- First press  to turn-off the display of the loading patterns.

Solving optimised loading arrangements

So, as seen, the VLO run includes loading arrangements that can be optionally visualised but produces no structural results. Results are available only after the VLO analysis has been solved. So:

- With the model view window active, press the Solve Now  button.



Only the VLO analysis has to be solved in order to produce the results for the optimised loading arrangements for each influence assignment. The Solve Now dialog indicates that the VLO DMI My analysis results are not up to date and that they need to be solved. The other two analyses are unselected by default, as their results are up to date.

- Press **OK** to solve the VLO run.

The results will be loaded on top of the current model, with the last viewed VLO DMI My analysis loadcase set active by default.

Viewing results

Plotting bending moments

- In the  Treeview, and from within the VLO DMI My, LM1 All section, select the **My Influence (My) – (463.28, 213.24, 0.0) – Negative - Characteristic** results loadcase and choose **Set Active**.
- In the  Treeview turn off the **Geometry** and **Attributes** layers.
- With no features selected right-click in a blank part of the Graphics window and select the **Diagrams** option to add the **Diagrams** layer to the  Treeview
- In the diagram properties drop-down menu, pick **Force/Moment** from the entity and **My** from the component drop down list.
- From the **Diagram Display** tab deselect the **Use for labels too** option (to draw labels in black by default), select **Decimal places** and change the value to **1**
- Press **OK** to return to the properties dialog, and then press **OK** exit.

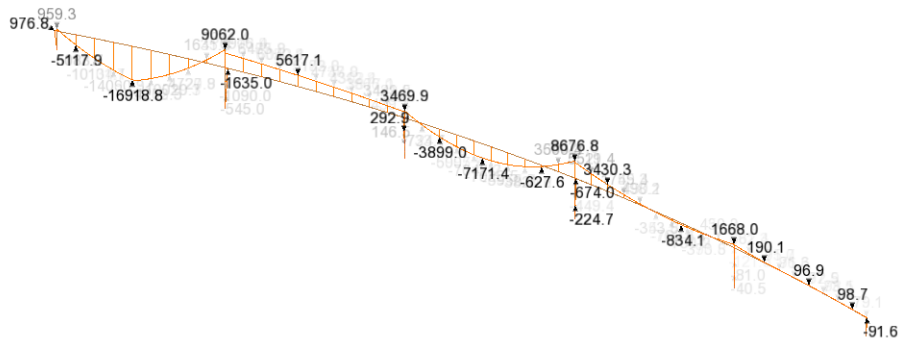

The preceding diagram shows the worst-case sagging moment, M_y , for span 5, due to characteristic LM1 loading.

- In the  Treeview, and from within the VLO DMI M_y , LM1 All section, select the **My Influence (M_y) – Point 6 - (Line 6) – Positive - Characteristic** and choose **Set Active**.

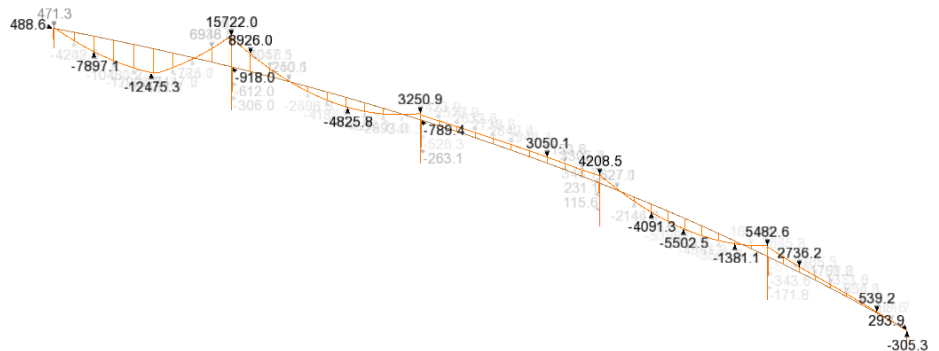

The preceding diagram shows the worst-case hogging moment, M_y , which occurs at pier 4, due to characteristic LM1 loading.

Using the procedures described in this example, lines representing each span can be selected, onerous loading patterns can be created, loadcases solved, and the corresponding results for each span can be inspected.

This completes the example.

Discussion

This example just shows how a single influence component (My) can be defined and assigned as an attribute to nodes within the lines representing the deck. Other influence attributes such Mx, for investigating torsional effects, could be assigned to nodes in the deck also, with loading and results effects being obtained in exactly the same way. Investigation of axial forces at pier heads can also be achieved in a similar fashion, but by making assignments only to the points at those locations.

VLO analysis naming conventions

One Direct Method Analysis entry could contain a single Vehicle Load Optimisation run, for all assigned influence components of interest, but for large models this could result in a great deal of unstructured data within the Analyses  treeview that is not easily viewable.

It is often better to have a single Direct Method Analysis entry containing multiple VLO run entries of suitable names such as Deck, or Pier, even including additional references to load types, since this will simplify the viewing and provide a 'structure' to the data in the Analyses  treeview and also make the identification of results loadcases easier when results processing.

Appending an influence component name to a Direct Method Analysis entry or a VLO Run name (if they only contain assignments for a single influence type) may also be useful if many entries are present in the Analyses  treeview, and some of these entries are contracted when other entries are being viewed.