

Railway Load Optimisation

For LUSAS version:	24.0
For software product(s):	LUSAS <i>Bridge</i> and LUSAS <i>Bridge Plus</i>
With product option(s):	Vehicle Load Optimisation
Note:	The example exceeds the limits of the LUSAS Teaching and Training Version

Description

Railway Load Optimisation (provided as part of the Vehicle Load Optimisation software option) is used to evaluate worst-case loading patterns for predefined track layouts on a ladder-type rail bridge modelled using beams. The international railway bridge loading code UIC 776-1-R is used.

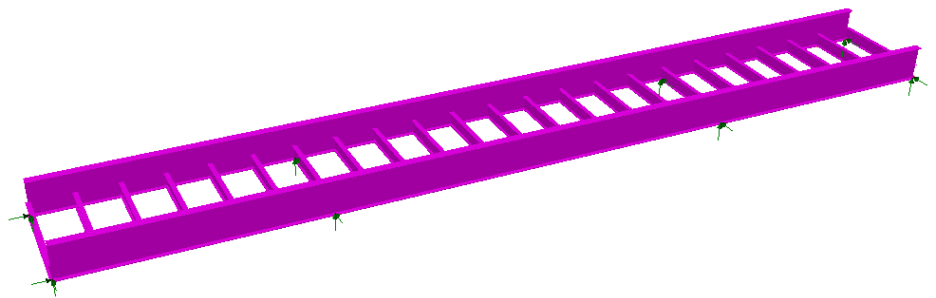

Bridge as modelled

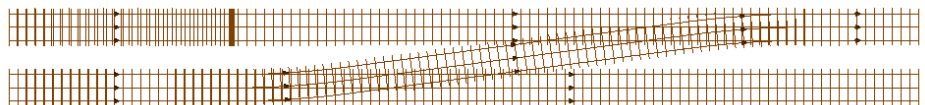

Track arrangement supported by structure

The structure consists of a square ladder arrangement formed from two longitudinal steel plate girders, at 6.1116m spacing, supporting transverse rolled steel 'I'-beams. The deck is assumed not to contribute to global stiffness and is therefore omitted in this analysis. Dummy longitudinal members are used in the search area such that live loading is only applied to the transverse members. Two end spans of 13.992m flank a main span of 23.320m; spans measured between the centrelines of the support bearings.

Lines defining the centreline of tracks that are supported by the structure are pre-defined in the supplied model. These lines are for use with the track definition and track layout facilities as described in the example.

Units of **N, m, t, s, C** are used throughout.

Objectives

The output requirements of the analysis are:

- Maximum live bending moments in the main girders

Keywords

3D, Beam, Track Definition, Track layout, Direct Method Influence, Railway Load Optimisation, Onerous Loading Patterns.

Associated Files

Associated files can be downloaded from the user area of the LUSAS website.



- rail_bridge.lvb** creates the model geometry with all required attributes assigned. The example will use the model created by this file as a starting point.

Running LUSAS Modeller

For details of how to run LUSAS Modeller see the heading *Running LUSAS Modeller* in the *Introduction to LUSAS Worked Examples* document.

Modelling



Note. Model and results images included in this example were captured in an earlier version and may differ in appearance from those seen and obtained from this version.

Creating the model

- Enter a file name of **rail_bridge**
- Use the default **User-defined** working folder.

File
New...

- Ensure an Analysis type of **3D** is set.
- Click the **OK** button.



Note. There is no need to enter any other new model details when the intention is to run a script to build an initial model, since the contents of the script will overwrite any other settings made.

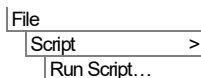

To create the model, open the file **rail_bridge.lvb** that was downloaded and placed in a folder of your choosing.



Save the model.

Railway load optimisation in LUSAS

Railway Load Optimisation (RLO) makes use of influence surfaces and influence analysis to identify the most onerous rail loading patterns on bridges for a chosen design code and to apply these loading patterns to LUSAS models. RLO allows the definition of parameters, for a particular design code, to generate the most critical rail loading pattern for each influence shape under consideration. In this example, the model is loaded according to design code UIC 776-1-R, but the modelling methods described can similarly be used for any other supported design code.

Track definitions

Track definitions are used by rail track layouts to specify particular track loading scenarios. In this model, the lines and arcs which represent the centreline of separate lengths of loadable length of track have been pre-defined and saved as groups.



Note. If desired, and for clarity, the lines defining the centreline of a track could be defined to lie above the plane of the beams or surface elements to which the rail loading will be applied. Rail loading is projected onto beams and surfaces as part of the Rail Load Optimisation process.

'Up Fast'

- In the  Treeview right-click on **Up Fast CL** and choose **Select Members** to select the lines that define the centreline of the Up Fast track.

Railway Load Optimisation

Bridge
Railway Load
Optimisation
Track Definition...

- Leave the Transverse distance between rail loads on the track set to be **1.495**
- Enter a name of **Up Fast** and click **OK**.

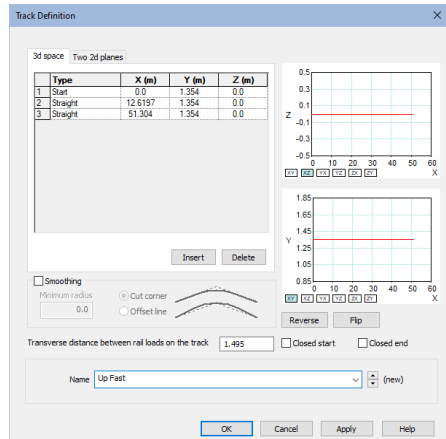

A representation of the track is drawn on the model, and a Track Definition object is added to the  Treeview.

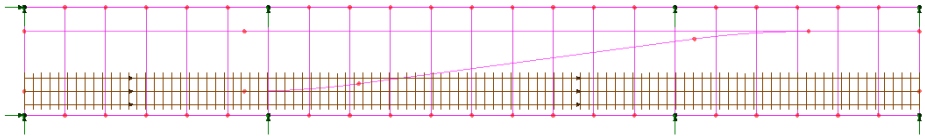

Note. The order of the line segments selected will determine the start point and direction of the track definition. Note that lines defining track centrelines do not have to be meshed or form a structural part of the model.

‘Up Slow’

- Next, in the  Treeview, right-click on **Up Slow CL** and choose **Select Members** to select the lines that define the centreline of the track.
- Name the track definition **Up Slow** and click **OK**.

The track visualisation will be added to the display.

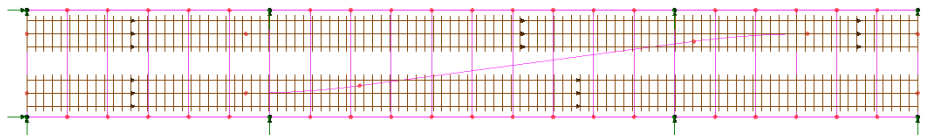

Bridge
Railway Load
Optimisation
Track Definition...

'Crossover Fast to Slow'

- In the  Treeview right-click on **Up Fast to Up Slow Crossover** and choose **Select Members** to select the lines that define the centreline of the track.
- Name the track definition **Crossover Fast to Slow** and click **OK**.

Bridge
 Railway Load
 Optimisation
 Track Definition...

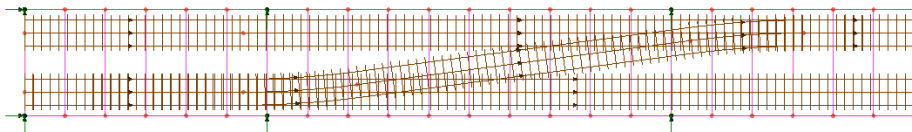

The track visualisation will be added to the display.



Note. In this example the centreline of the crossover track has been represented with lines and arcs. As an alternative, the crossover length could have been modelled with a single straight line as long as the Smoothing option 'Cut corner' was specified on the Track Definition dialog along with a minimum radius.

'Up Slow to Signal'

- Finally, select only line number **2005** (the left-hand end of **Up Slow CL**) in the view window. This will be used to define the part of the Up Slow track that can be loaded simultaneously with the crossover.
- Select the **Closed end** option, name the track **Up Slow to Signal**, and click **OK**.

Bridge
 Railway Load
 Optimisation
 Track Definition...

The closed end of the track at the signal is represented by the drawing of a thickened line for the sleeper at that location.

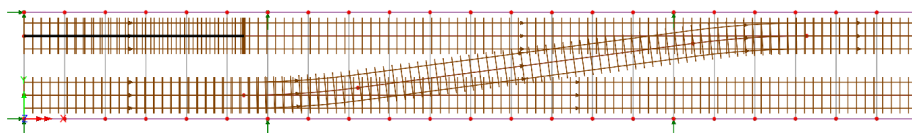

Visualisation of individual track definitions

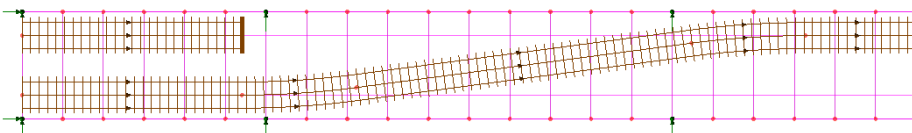

- By right-clicking on **Up Slow** in the  Treeview and deselecting **Visualise**, then repeating the same for **Up Fast**, the **Crossover Fast to Slow** and **Up Slow to Signal** the individual track definitions can be seen:



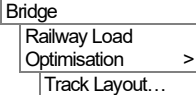

Defining track layouts

A track layout defines which of the track definitions can be loaded simultaneously in a Rail Direct Method Influence analysis. Multiple track layouts can be defined by including and excluding track definitions and changing the track layout name as appropriate.

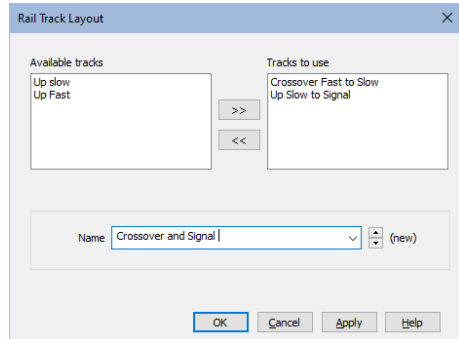
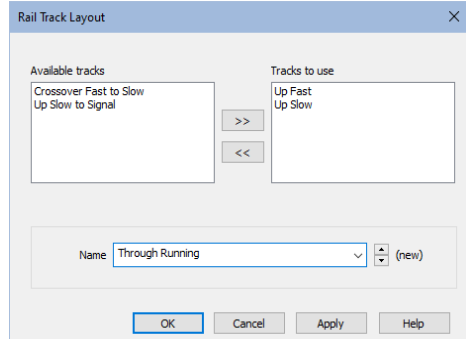

- In the ‘Available tracks’ panel, click on **Up Fast**, then holding down the Shift key also click on **Up Slow**. Click the ‘Add to’ button  to move these into the ‘Tracks to use’ panel.
- Enter a name of **Through Running** and click **Apply**.
- Then, select the **Up Fast** and **Up Slow** entries in the ‘Tracks to use’ panels and press the ‘Remove from’ button  to return them to the ‘Available Tracks’ panel.
- In the ‘Available tracks’ panel, select **Crossover Fast to Slow** and **Up Slow to Signal** and add these to the ‘Tracks to use’ panel.
- Change the rail track layout name to **Crossover and Signal** and click **OK**.



The Track Layout objects created can be seen in the  Treeview.

Visualisation of individual track layouts



Note. If the Rail Track Layout Definition Visualisations are set to ‘None’, right-clicking on a track layout in the  Treeview and selecting **Visible** or **Invisible** will enable the individual track definitions to be seen.

Defining influence attributes

In order to use the Railway Load Optimisation facility, the locations at which the optimised load combinations are to be calculated and the component to be computed must be chosen. To do this, direct method influence attributes are defined and assigned to the model. LUSAS then calculates the influence surfaces for any specified position in the structure. An influence surface is generated for each of the chosen locations and components.



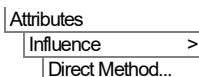

Note. Direct Method Influence attributes must be used for Railway Load Optimisation. The Reciprocal Influence method is not compatible.

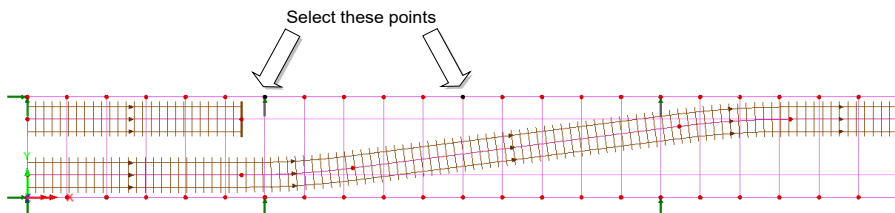

- Select an Entity of **Force/Moment – Thick 3D Beam**, a Direction of **Element local** and a Component **My inf**. Name the influence **My inf** and click **OK**.
- In the view window select Points **213** and **393** to investigate hogging over the internal pier and mid-span sagging of the beam in the main span respectively:



- Drag and drop direct method influence **My inf** from the  Treeview onto the selected points. This will bring up the Rail DMI Analysis dialog.
- Ensure that both track layouts are checked (ticked) and the Search area is **Deck**, then click **OK**.

Six influence entries will be created in the  Treeview; one for each of the three lines that meet at the two selected points.

As we are not interested in the transverse beams for this example (lines 396 and 761), and the moment won't change between the pairs of longitudinal lines that meet at a common point (excepting the insignificant torsion from the transverse beam) – namely lines 2013 and 2014, and lines 2018 and 2019, all influences except those defined for Line 2014 and Line 2019 can be deleted.

- Delete the influence entries for lines **2013**, **396**, **2018** and **761** from the  Treeview.

Running the analysis



Open the **Solve Now** dialog and press **OK** to solve Analysis 1 and Rail DMI Analysis 1.

Viewing the Results

Visualising the influence shape

- In the Treeview, set active the influence for **Point 213** (Line 2014).
- With no features selected right-click in a blank part of the view window and choose **Influence shape...** to add this layer name to the Treeview.



Note. The **Deformed mesh** layer is renamed **Influence shape** when an influence loadcase is active.

For an on-screen deformation magnitude of 20mm and when viewed using an isometric view , this influence shape will be seen:

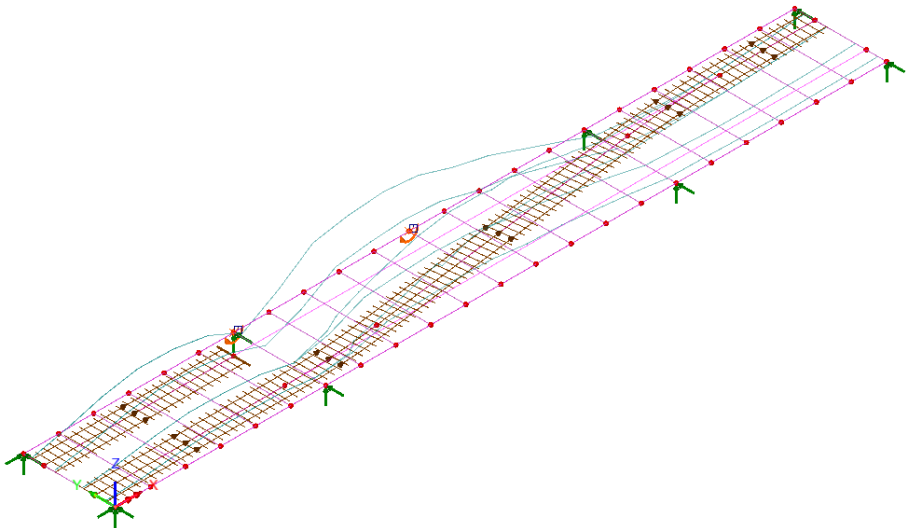

Note. The influence shape for a particular track layout can only be displayed if that track layout is set to be visible.



Note. For a Rail Direct Method Influence analysis nodes are created automatically where each rail intersects with an element in the search area. In this way, the number of

locations where a unit load can be applied is minimised and ensures that the influence shapes are drawn following the alignment of each rail track, because loading can only be applied along the rails, and not elsewhere on the model.



Note. Once a Direct Method influence analysis for rail use has been solved for one assigned attribute the effect of a unit load on any part of the structure can be seen immediately for any subsequently assigned influence attributes.

Using the Railway Load Optimisation facility to calculate the worst loading patterns

The Railway Load Optimisation facility automates the creation of load datasets in accordance with the chosen loading code for the locations and effects specified.

For track layout ‘Through Running’

- Set Country to **International** and Design Code to **UIC 776-1-R**.
- Click **Optional code settings...**
- On the UIC 776-1-R dialog **uncheck** all Design situation and limit states except for **ULS Characteristic – Leading**. Ensure it is selected.
- In the Factors panel select **Single L_{ϕ} for all influences** and enter a value of **23.32**
- Click **OK**.

The value of 23.32 is used because the main girders on a three-span continuous bridge are being investigated. UIC 776-1-R Table 2 Case 5.1 gives an L_{ϕ} of 1.3 times the average span length ($51.304 / 3 * 1.3 = 22.23\text{m}$), but not less than the longest span, which is 23.32m

- On the main RLO – Influence dialog click **Set influence surfaces....**

Bridge
 Railway Load
 Optimisation >
 RLO Run...

- Check the **Include all influence surfaces** option.
- Ensure only **Positive** (i.e. hogging) is selected for Point 213 (Line 2014).
- Ensure only **Negative** (i.e. sagging) is selected for Point 393 (Line 2019)

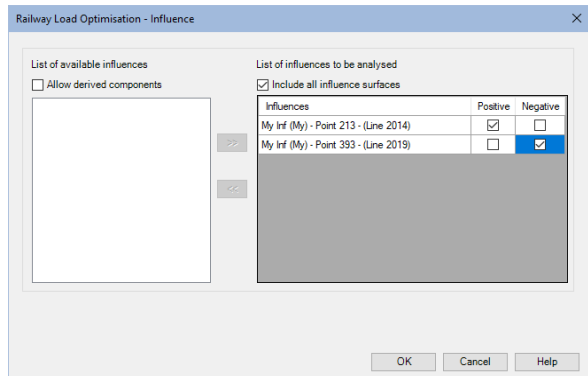

- Click **OK**.
- On the main RLO – Influence dialog ensure that the track layout **Through Running** is selected from the drop-down list.
- Ensure that **View onerous effects table** is selected.
- Change the RLO name to be **Through running** and click **OK**.

Selection of the tabs on the onerous effects table generated show optimised results of **8.12363E6** for hogging at the support.

Through running My inf (My) ~ Positive ~ ULS Characteristic Leading					
	Influence Assignment▲	Node	My	Caused by	Create loading
1	Point 213 - (Line 2014)	103	8.12363E6	SW2 with SW0 ULS_Char_Leading	Create loading

And a value of **-7.34646** for sagging at mid-span.

Through running My inf (My) ~ Negative ~ ULS Characteristic Leading					
	Influence Assignment▲	Node	My	Caused by	Create loading
1	Point 393 - (Line 2019)	188	-7.34646E6	LM71 ULS_Char_Leading Unrestricted	Create loading

- Close the table.

For track layout 'Crossover and Signal'

The Rail Load Optimisation run created for the track layout named 'Through Running' can be copied, renamed and edited to provide results for the track layout 'Crossover and Signal' as follows:

- In the  Treeview right-click on **Through Running** and select **Copy** and then **Paste** to create a new entry.
- Rename the new entry to be **Crossover and Signal**
- Right-click on **Crossover and Signal** and select **Edit**
- On the main RLO – Influence dialog ensure that that the track layout **Crossover and Signal** is selected from the drop list.
- Ensure that **View onerous effects table** is selected and click **OK**.

The onerous effects table generated now shows optimised results of **4.73990E6** for hogging at the support at point 213.

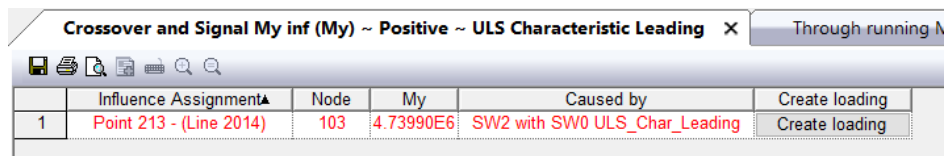

	Influence Assignment▲	Node	My	Caused by	Create loading
1	Point 213 - (Line 2014)	103	4.73990E6	SW2 with SW0 ULS_Char_Leading	Create loading

And a value of **-3.39507E6** for sagging at mid-span at point 393.

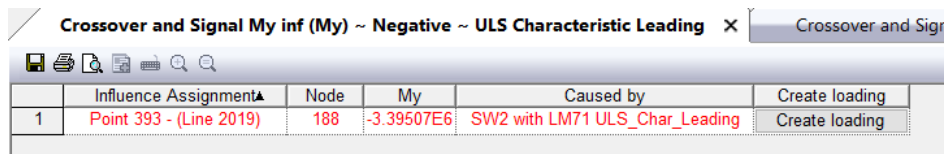

	Influence Assignment▲	Node	My	Caused by	Create loading
1	Point 393 - (Line 2019)	188	-3.39507E6	SW2 with LM71 ULS_Char_Leading	Create loading

This shows that, unsurprisingly, having both tracks fully loaded in the main span is more onerous for the main girder than having the crossover loaded, with another train stopped at a signal on an adjacent section of track.

- Leave the results table displayed.



Creating onerous rail loading patterns for track layout 'Crossover and signal'

Onerous load patterns can be created on a case-by-case basis if they were not created by means of the 'Create loading patterns' setting on the main RLO dialog (which they were not in this example).

Maximum hogging at Point 213 – (Line 2014)

- For the onerous effects table for **Crossover and Signal**, and with the **My inf (My) – Positive – ULS Characteristic Leading** tab selected, click the **Create loading** button.

Railway Load Optimisation

Discrete point and patch loads will be added to the  Treeview, along with a loadcase entry in the  Treeview.

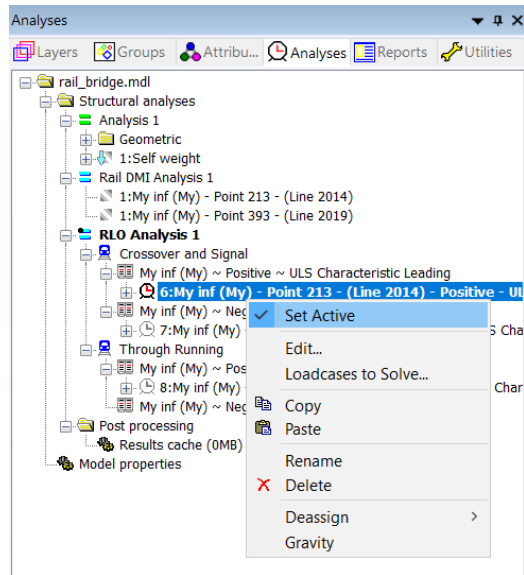

- In the  Treeview, and for the **Crossover and Signal** entry, expand the **My inf (My) – Positive – ULS Characteristic Leading** and right-click on the loadcase **My inf (My) – Point 213 – (Line 2014) – Positive – ULS Characteristic Leading** and choose **Set active**.

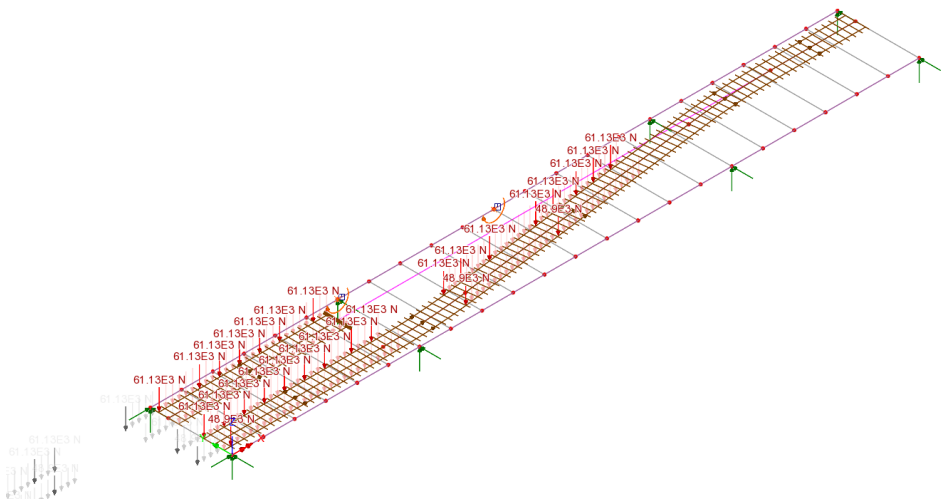

- Ensure the visualise loading  button is turned on, to see the optimised loading:



For maximum sagging at Point 393 – (Line 2019)

- By viewing the results table for **My inf (My) – Negative – ULS Characteristic Loading** and selecting the **Create loading** button for that onerous condition, additional discrete point and patch loads will be added to the  Treeview, along with a loadcase entry in the  Treeview. When the loadcase **My inf (My) – Point 393 – (Line 2019) – Negative - ULS Characteristic Leading** is set active the following load pattern can be seen:

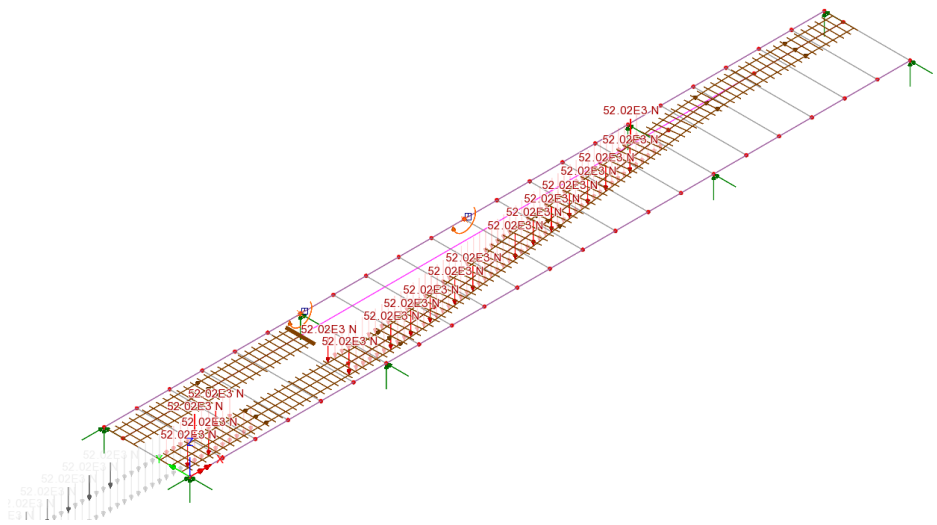

Onerous rail loading patterns for track layout ‘Through Running’ could be created and viewed in a similar manner.



Note. Onerous results loadcases can be solved to get coincident effects and be used in combinations and envelopes.

Save the model



Save the model file.

This completes the example.

File _____
Save _____

